

Via Monfalcone 41
20092 Cinisello Balsamo (Milano) – Italy
Tel. +39 0266013695 – Fax +39 0266013500

CODE NUMBER: 120000001119

SUBJECT: PLJT1535 - Diffuser-Lens for COBs LEDs



- High diffusion flux
- High luminous intensity
- Perfect uniform light distribution
- Provided with a special adaptor allowing immediate easy assembling by a simple twist & lock block system.
- Easy fixing system onto the COB LED XICATO®
- No vibration problems
- Available in fine-frosted and milky white finish
- Complying with UL94 Specifications
- UV protected

Typical Applications:

Khatod KPLJT Series are suitable for any application in General Lighting, Indoor and Outdoor:

- Step-marker
- Signalling
- Lamps
- Architectural lighting
- Any applications where a diffused soft lighting is requested

Khatod's focus on secondary optics for the major LEDs manufacturers has required great technical and productive efforts to meet the needs of the market. The creation of complete series of lenses has caused us to invest in research, and greater production capabilities.

KPLJT Lens systems from Khatod perform a uniform diffused soft light. They are real diffusers with Lambertian reflectance: their brightness as well as their flux are perfectly uniform.

The new series of KPLJT lens systems are provided with a special adaptor, customized for the individual models of COB LEDs, allowing an immediate easy assembling of the diffuser-lens by a simple twist & lock block system. The concept is very simple: first the adaptor is fixed onto the COB LED while the diffuser-lens is then fixed by simply twisting and locking it onto the adaptor.

Our unique optical systems allow the customer to choose the highest in design and the easiest in usability, being certain that they are provided with the most efficient and cost-effective optical solution.

Contents

1	Light Source Model	3
2	Measurement Setup	3
3	Results	3
4	Intensity Plot	4
5	Illuminance Map	5
6	Isolux / Isocandela Plots	6
7	Illuminance Diagram	7
8	Drawing	8
9	Use and Maintenance	9

1 Light Source Model

Parameter	Symbol	Value	Unit
Lens / Reflector Model	-	PLJT1535	-
Material (More info on page 9)	-	PC	-
Dimensions	-	See page 8	-
Source Model	-	XICATO XSM 8027 1000	-
Number of Sources	N	12	-
Power Supply Type	-	ISO TECH ISP3303	-
Driver Type	-	-	-
Driving Voltage	V_F	-	V
Driving Current	I_F	700	mA
Nominal Flux	Φ	1000×12	lm

2 Measurement Setup

Parameter	Symbol	Value	Unit
Operator	-	Simone Bassi	-
Goniophotometer Type	-	KLX12M	-
Measurement Distance	z	5	m
Room Temperature	T	25	°C
Date	-	28-Jun-2012	-

3 Results

Parameter	Symbol	Value	Unit
Total Flux	Φ	1000	lm
Max Intensity	I_{max}	300	cd
Max Illuminance at 5 m	E_{max}	12	lx
C-Viewing Angle at 50% I_{max}	$2\varphi_C$	101	°
γ -Viewing Angle at 50% I_{max}	$2\varphi_\gamma$	101	°
C-Viewing Angle at 10% I_{max}	$2\varphi_{C10\%}$	128	°
γ -Viewing Angle at 10% I_{max}	$2\varphi_{\gamma10\%}$	128	°
General Optical Measurement Tolerance	-	±10%	-

NOTES:

- Intensity (I) and illuminance (E) data are normalized by 1000 lm

4 Intensity Plot

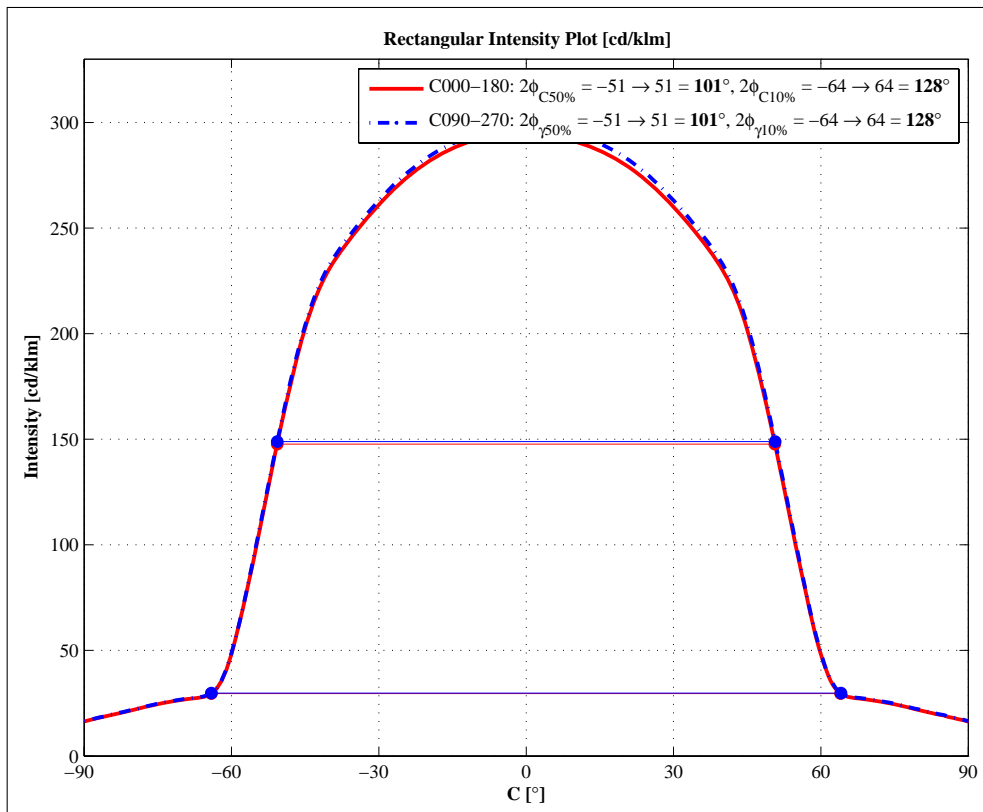
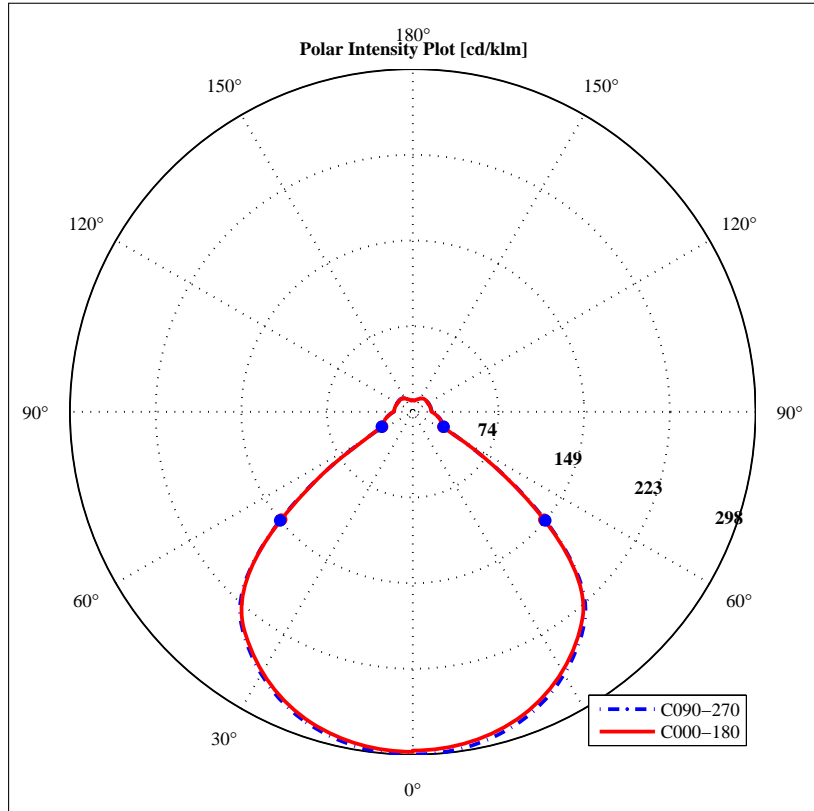

5 Illuminance Map

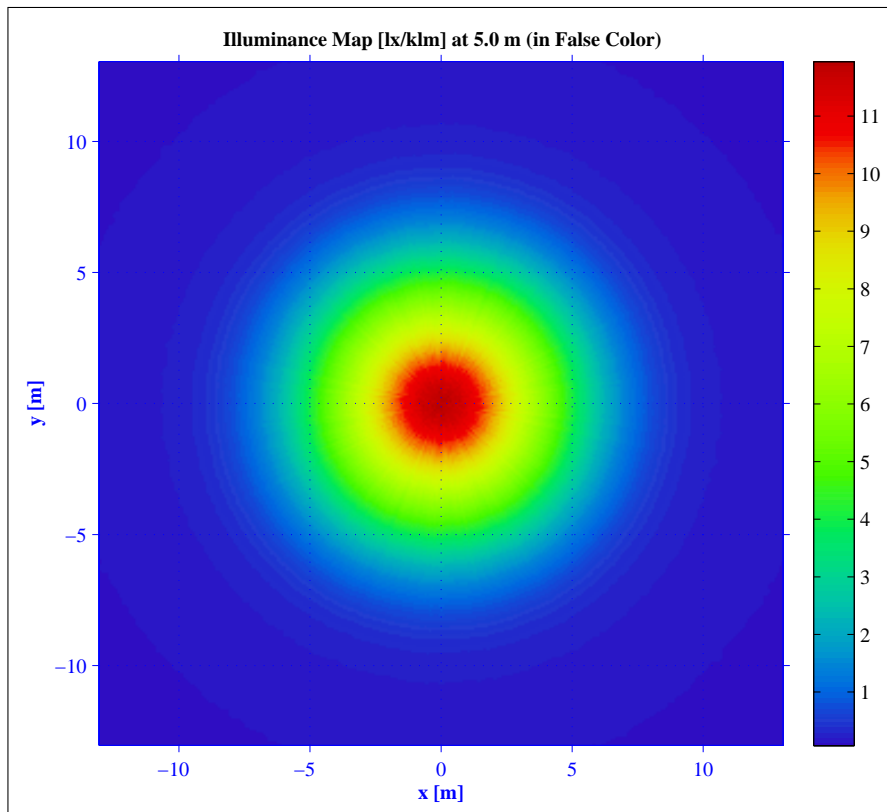
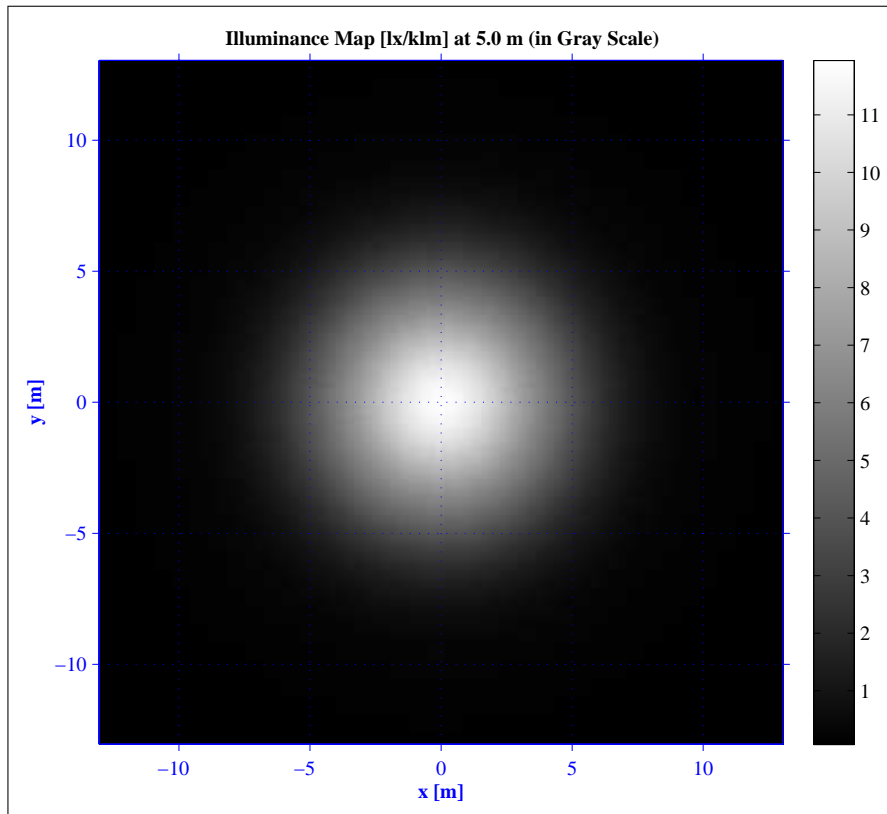

6 Isolux / Isocandela Plots

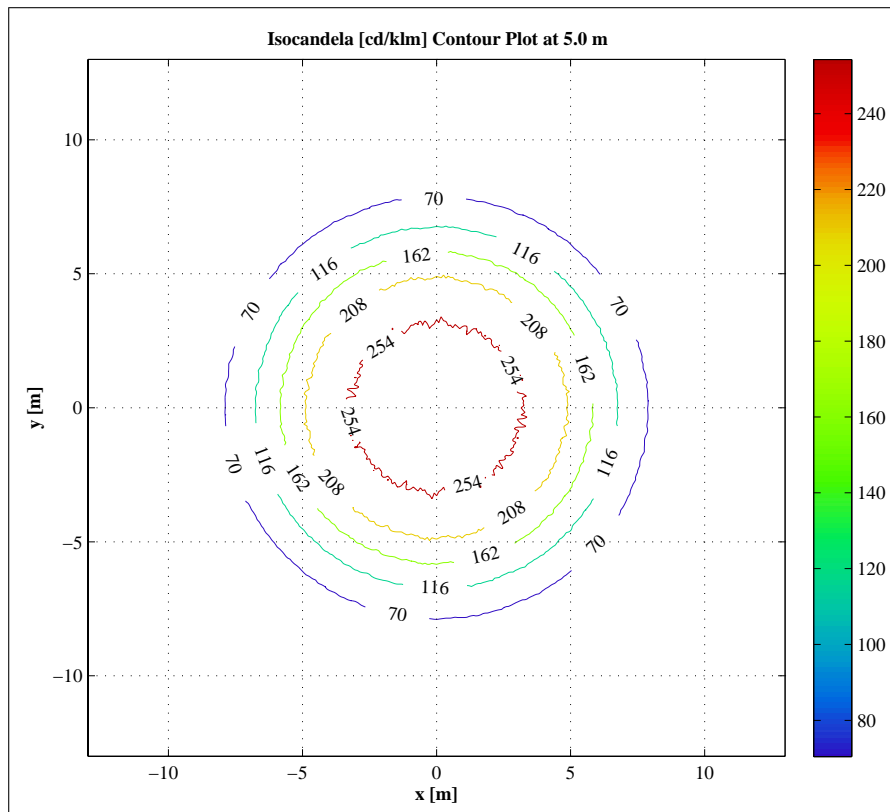
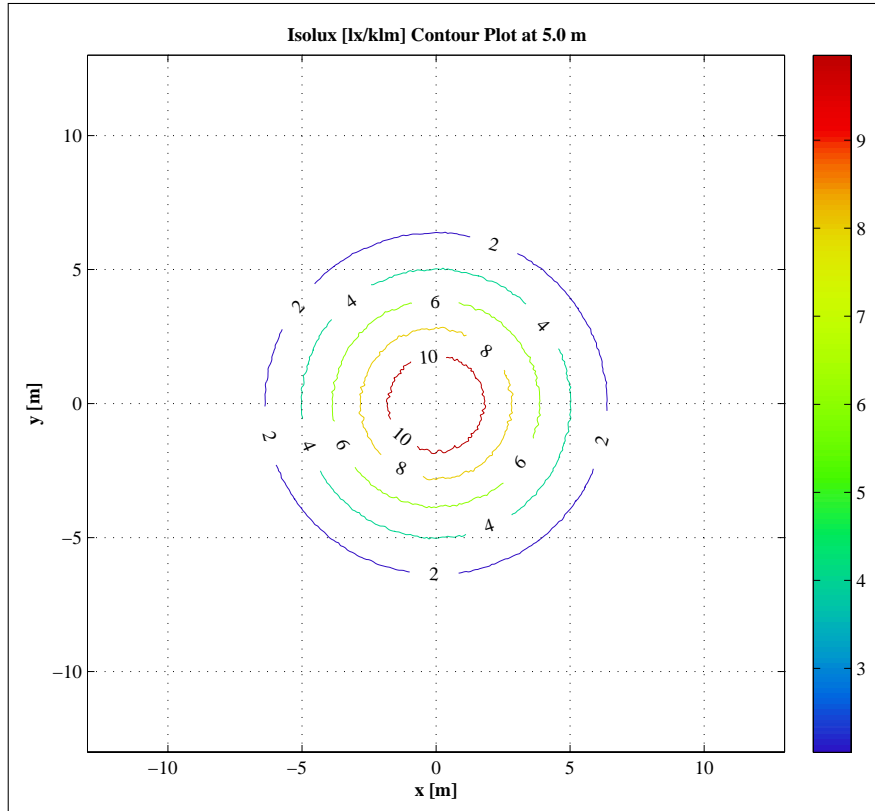

7 Illuminance Diagram

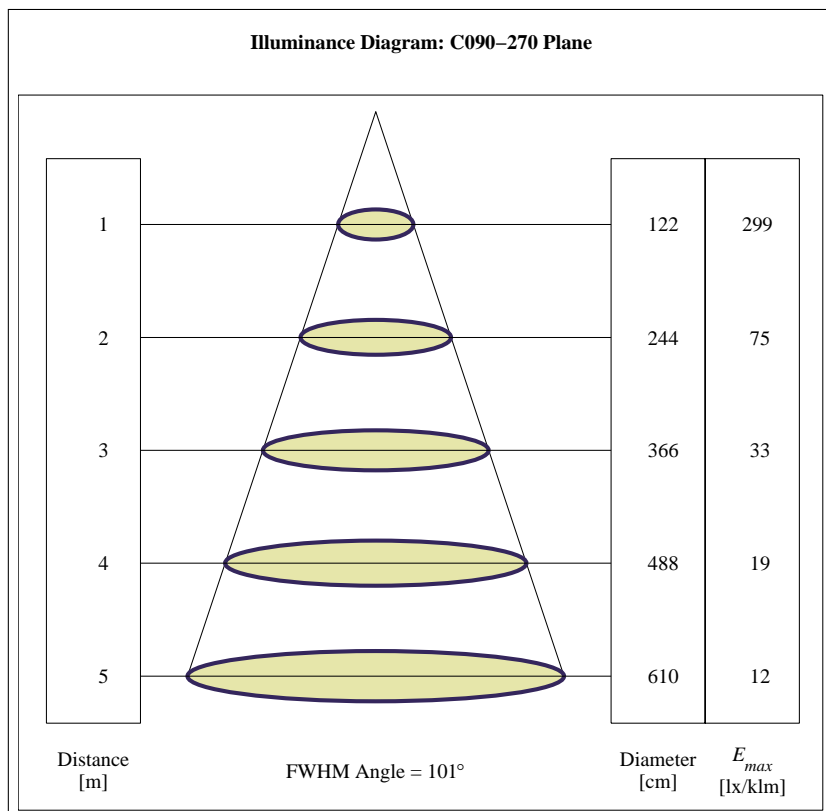
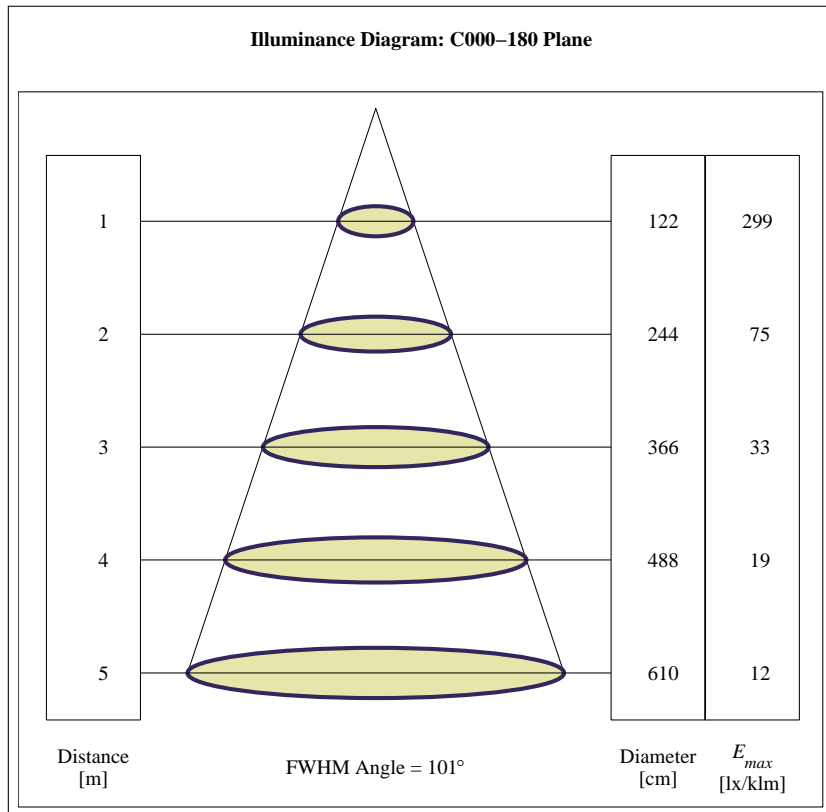

8 Drawing

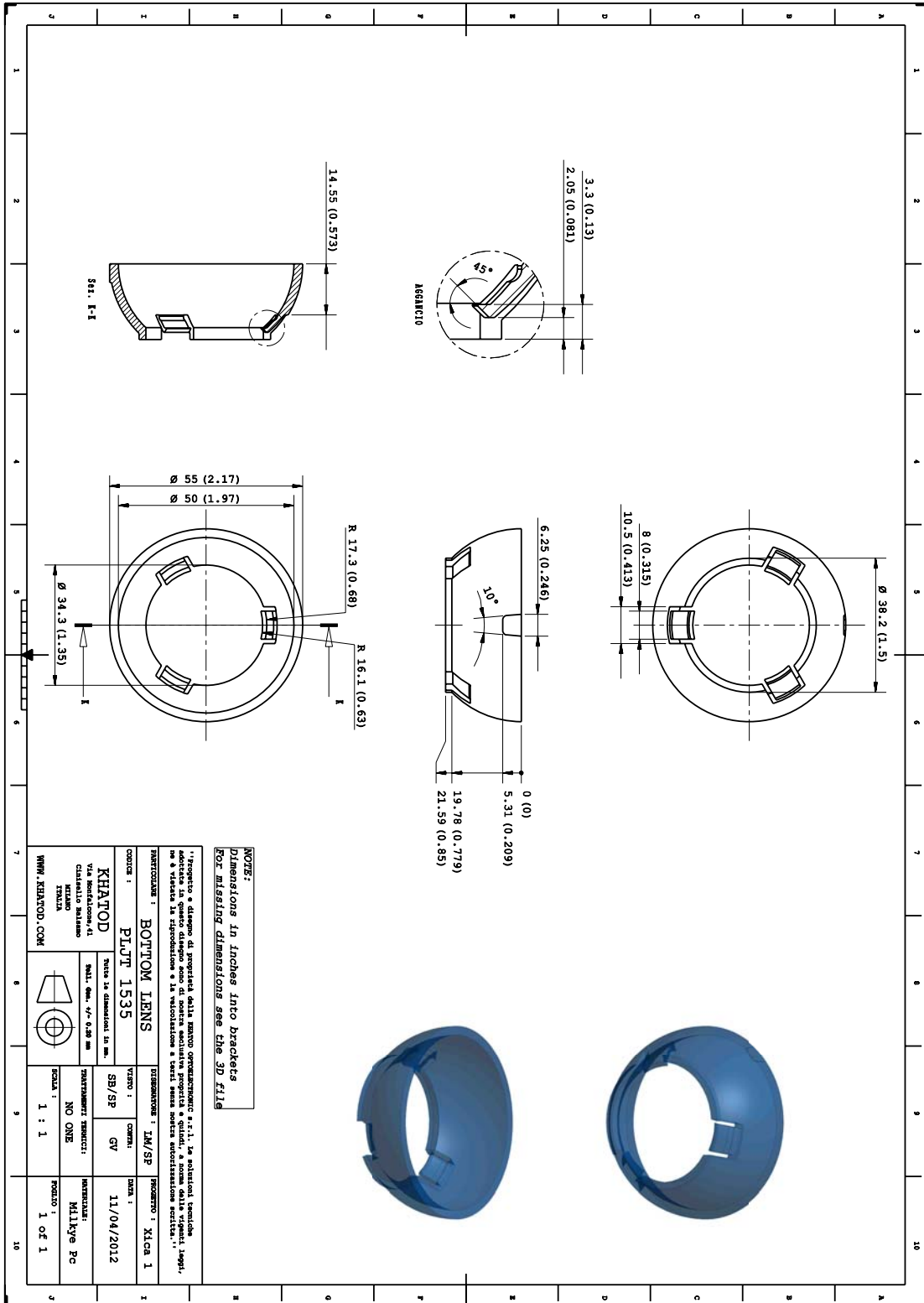

9 Use and Maintenance

Lens characteristics

Parameter	Symbol	Rating	Unit
Lens Material	PC Optics	--	--
Holder Material	--	--	--
Operating Temperature	Topr	-40 to +120	°C
Storage Temperature	Tstg	-40 to +120	°C

Notes:

Please note that flow lines and weld lines on the external surfaces of the lenses are acceptable if the optical performance of the lens is within the specification described in the section “OPTICAL CHARACTERISTICS”

- Should you require further information, please contact Khatod for advice.
- All lens testing must be subject to identical conditions as Khatod test condition.
- Published by Khatod optoelectronic srl - All the data contained in this document are the property of Khatod optoelectronic srl and may change without notice.

KHATOD LENS Use And Maintenance

- DO NOT HANDLE OR INSTALL LENSES WITHOUT WEARING GLOVES, SKIN OILS MAY DAMAGE LENS OR LIGHT TRANSMISSION
- CLEAN LENSES WITH MILD SOAP AND WATER AND A SOFT CLOTH
- DO NOT USE ANY COMMERCIAL CLEANING SOLVENTS ON LENSES

Khatod SRL, Milan, Italy, manufactures lenses for LEDs. Any other use of the lens shall void our liability and warranty. The lenses are an inert component to be used in the manufacture of various products. Our warranty and liability are limited only to the manufacture of the lens. You may not modify, copy, distribute reproduce, license or alter the lens and related materials of Khatod SRL. Khatod SRL does not warrant against damages or defects arising out of the use or misuse of the products; against defects or damage arising from improper installation, or against defects in the product or in its components. No warranty of any kind, expressed or implied, is made regarding the safety of the products. The entire risk as to the quality or performance of the product is with the buyer. In no event shall Khatod SRL be liable for any direct, indirect, punitive, incidental, special, consequential damages, or any damages whatsoever arising out of or connected with the use or misuse of the product. Khatod SRL shall not have any obligation with respect to the product or any part thereof, whether based on contract, tort, strict liability or otherwise. Buyer assumes all risks and liability from use of the product. The laws of Milan, Italy govern this product warranty and liability and you hereby consent to the exclusive jurisdiction and venue of courts in Milan, Italy in all disputes arising out of or relating to the use of this product. Production, marketing, distribution, sale of these products as well as their possible modifications and variations are only exclusive right of Khatod Optoelectronic S.r.l. No company can perform any of these actions without written permission released by Khatod Optoelectronic S.r.l. - REPRODUCTION PROHIBITED -