

Tous droits strictement reserves. Reproduction ou communication a des tiers interdite sous quelque forme que ce soit sans autorisation écrite du propriétaire. Propriete de c FCI. Droits de reproduction FCI.

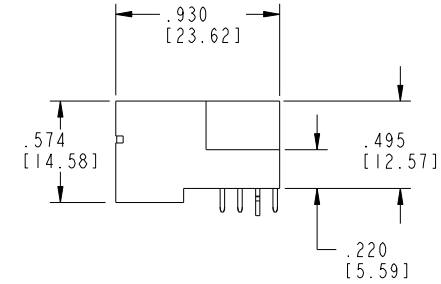

All rights strictly reserved. Reproduction or issue to third parties in any form whatever is not permitted without written authority from the proprietor. Property of FCI. Copyright FCI.

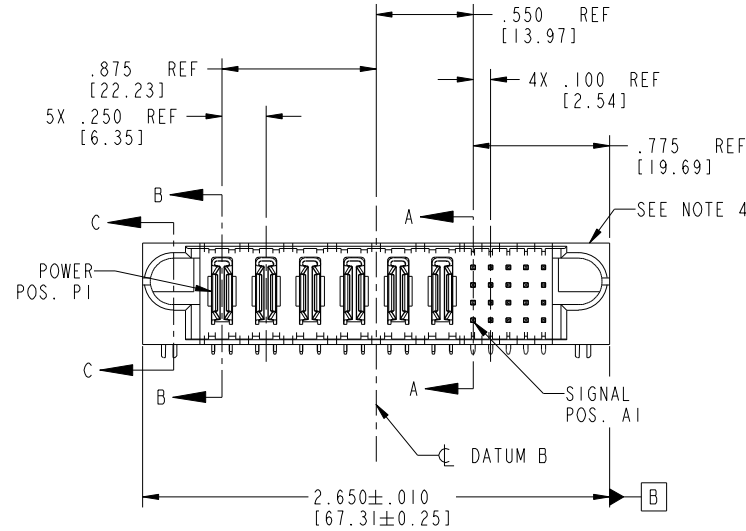
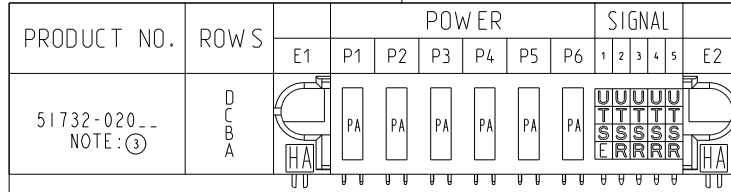

CODE	DIM "M" MATING LENGTH	CONTACT TYPE
E	.220 [5.59]	SIGNAL
R	.270 [6.86]	SIGNAL
S	.270 [6.86]	SIGNAL
T	.270 [6.86]	SIGNAL
U	.270 [6.86]	SIGNAL
PA	N/A [N/A]	POWER
HA	N/A [N/A]	HOLD-DOWN

mat'l code				SEE NOTE 2		tolerances unless otherwise specified		CUSTOMER		 www.fciconnect.com	
ltr	ecn no.	dr	date	linear	.XX±.01/0.X±0.3	projection		COPY		title	
J	DG08-0253	SH	09/15/08	angles	.XXX±.005/0.XX±0.13					6P + 20S RIGHT ANGLE SOLDER HEADER	
D	V04-0787	TAB	08/03/04		.XXX±.002/0.XXX±0.051					product family	
E	V04-0910	TAB	09/14/04	dr	0°±2°	INCH/MM				PwrBlade	
F	DG05-0319	CS	09/07/05	engr	T. BRUNGARD 05/25/04	scale				code	
G	DG05-0427	CS	10/28/05	chr	M. GRAY 05/25/04	1:1				213	
H	DG05-0501	GuoJM	11/24/05	appd	M. GRAY 05/25/04					sheet	
sheet index		revision sheet		J	J	J	J	A		51732-020	
		i		2	3	4				1 of 4	

cage code 22526

Pro/E

Tous droits strictement réservés. Reproduction ou communication à des tiers interdite sous quelque forme que ce soit sans autorisation écrite du propriétaire. Propriété de c.FCI. Droits de reproduction FCI.

All rights strictly reserved. Reproduction or issue to third parties in any form whatever is not permitted without written authority from the proprietor. Property of FCI. Copyright FCI.

PRODUCT NUMBER
51732-020--
NOTE:③

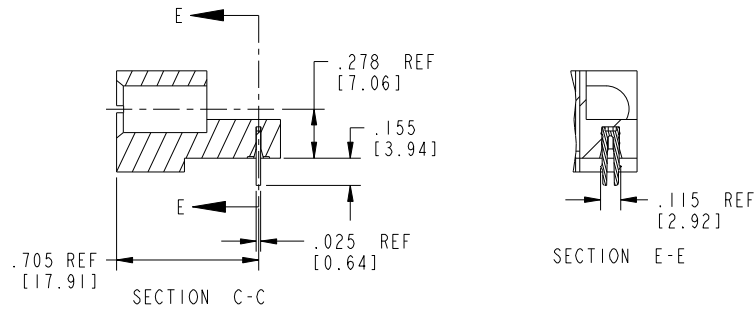
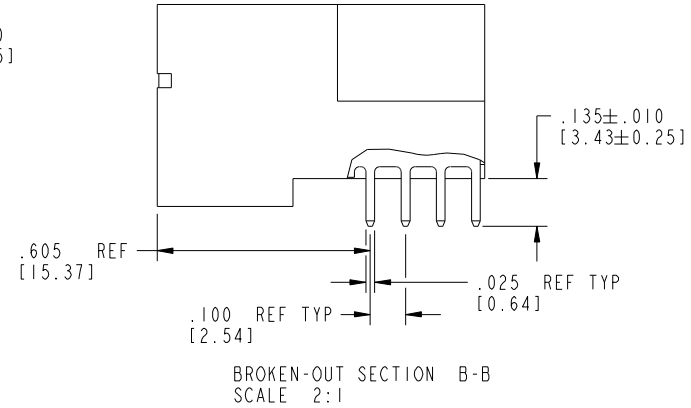
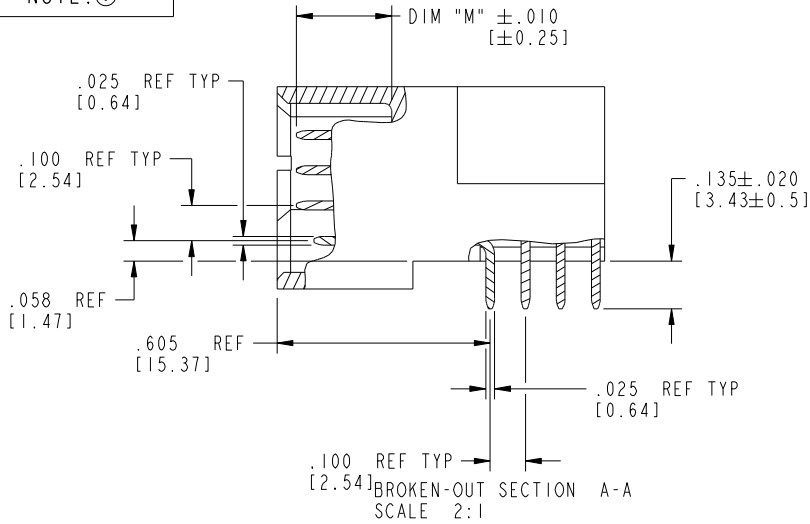

mat'l code		SEE NOTE 2		tolerances unless otherwise specified		CUSTOMER		FCI	
ltr	ecn no.	dr	date	linear	.XX±.01/0.X±0.3	COPY		www.fciconnect.com	
J				linear	.XXX±.005/0.XX±0.13	projection	title 6P + 20S		
				angles	.XXX±.0020/0.XXX±0.051			RIGHT ANGLE SOLDER HEADER	
				dr	0°±2°	INCH/MM		product family	PwrBlade
				enr	T. BRUNGARD 05/25/04	scale		size	code
				chr	M. GRAY 05/25/04	1:1		dwg no	213
				appd	M. GRAY 05/25/04	A		51732-020	sheet
sheet index	revision sheet								2 of 4

Pro/E

cage code 22526

Tous droits strictement réservés. Reproduction ou communication à des tiers interdite sous quelque forme que ce soit sans autorisation écrite du propriétaire. Propriété de c.FCI. Droits de reproduction FCI.



All rights strictly reserved. Reproduction or issue to third parties in any form whatever is not permitted without written authority from the proprietor. Property of FCI. Copyright FCI.

PRODUCT NUMBER
51732-020--
NOTE: ③

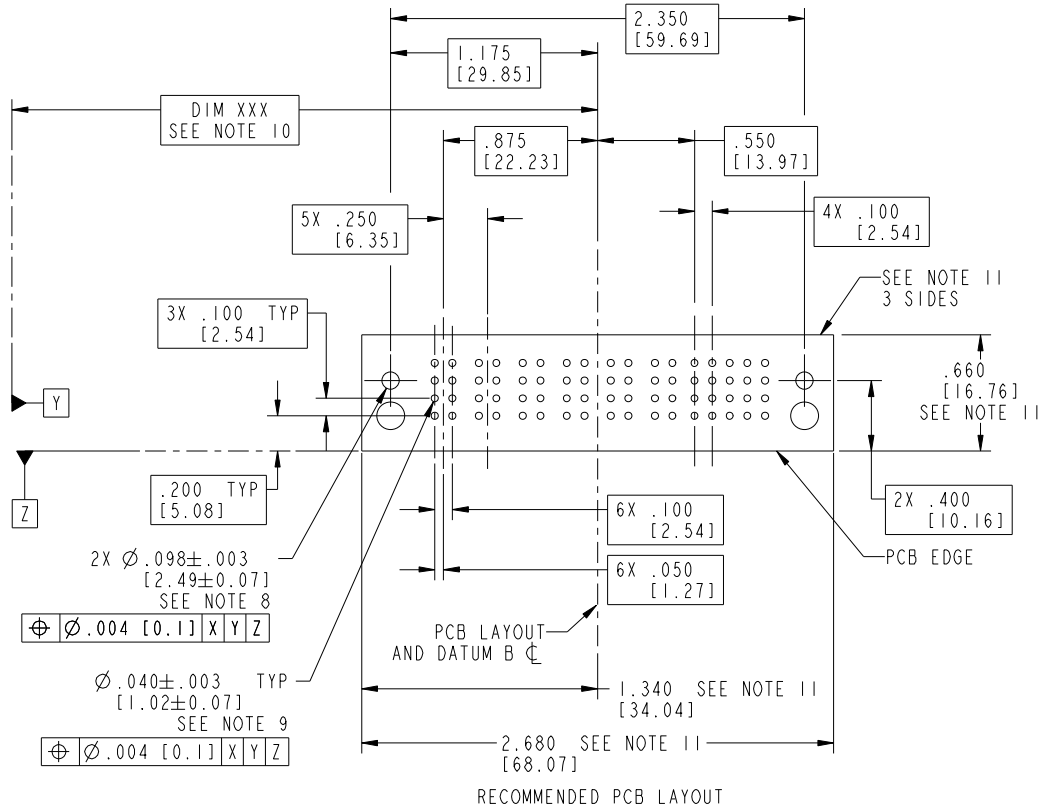

RECOMMENDED PCB LAYOUT

mat'l code		SEE NOTE 2		tolerances unless otherwise specified		CUSTOMER		FCI		www.fciconnect.com	
ltr	ecn no.	dr	date	linear	.XX±.01/0.X±0.3	projection	COPY	title			
J					.XXX±.005/0.XX±0.13			6P + 20S			
				angles	.XXX±.0020/0.XXX±0.051			RIGHT ANGLE SOLDER HEADER			
				dr	0°±2°			product family	PwrBlade	code	213
				enrg	T. BRUNGARD 05/25/04	INCH/MM		size	dwg no	sheet	213
				chr	M. GRAY 05/25/04	scale		51732-020		3 of 4	
				appd	M. GRAY 05/25/04	1:1					
sheet index	revision sheet										

cage code 22526

Pro/E

Tous droits strictement reserves. Reproduction ou communication a des tiers interdite sous quelque forme que ce soit sans autorisation écrite du propriétaire. Propriete de c FCI. Droits de reproduction FCI.



All rights strictly reserved. Reproduction or issue to third parties in any form whatever is not permitted without written authority from the proprietor. Property of FCI. Copyright FCI.

PRODUCT NUMBER
51732-020--
NOTE: ③

NOTES:

1. DIMENSIONS AND TOLERANCES ARE IN ACCORDANCE WITH ASME Y14.5M, 1994 UNLESS OTHERWISE SPECIFIED.

CONNECTOR NOTES:

②. HOUSING MATERIAL: UL 94 V-0 GLASS FILLED
HIGH-TEMP THERMOPLASTIC
POWER CONTACT MATERIAL: COPPER ALLOY
SIGNAL PIN MATERIAL: COPPER ALLOY

3. PLATING:
▲ SEE ITEM 1 & 2 IN PRINT 10064183 FOR PLATING SPEC OF 51732-020 AND 51732-020LF RESPECTIVELY

④. MANUFACTURER'S NAME, P/N, AND DATE CODE TO APPEAR ON THIS SURFACE.

5. PRODUCT SPECIFICATION GS-12-149.
APPLICATION SPECIFICATION BUS-20-067.

6. PACKAGED IN TRAYS.

PCB NOTES:

7. ALL HOLE DIAMETERS ARE FINISHED HOLE SIZE.

⑧. MOUNTING HOLES, WHERE APPLICABLE, ARE UNPLATED.

⑨. $\varnothing .0453 \pm .0010$ [1.151 \pm 0.025] DRILLED HOLES PLATED WITH .0003 [0.008] MIN SnPb OVER .001 [0.03] TO .003 [0.08] Cu PLATING TO ACHIEVE $\varnothing .040 \pm .003$ [1.02 \pm .07] HOLE.

⑩. "DIM XXX" TO BE DETERMINED BY THE CUSTOMER.

⑪. CONNECTOR KEEP-OUT ZONE.

12: A ▲ SYMBOL WILL BE NEXT TO ANY DIMENSION, VIEW, OR NOTE WHICH HAS BEEN MODIFIED WITH CURRENT DRAWING VERSION

mat'l code		SEE NOTE 2		tolerances unless otherwise specified		CUSTOMER		FCI		www.fciconnect.com	
ltr	ecn no.	dr	date	linear	.XX±.01/0.X±0.3	COPY		title			
J					.XXX±.005/0.XX±0.13	projection		6P + 20S			
				angles	.XXX±.0020/0.XXX±0.051			RIGHT ANGLE SOLDER HEADER			
				dr	0°±?	INCH/MM		product family		PwrBlade	code
				enrg	T. BRUNGARD 05/25/04	scale		size		dwg no	213
				chr	M. GRAY 05/25/04	1:1		A		51732-020	sheet
				appd	M. GRAY 05/25/04						4 of 4
sheet index	revision sheet										

cage code 22526

Pro/E