

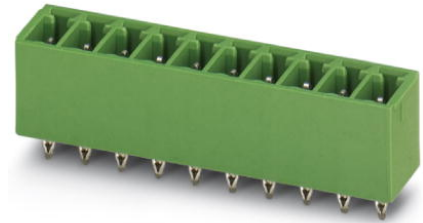

EMCV 1,5/10-G-3,81

Order No.: 1860728

<http://eshop.phoenixcontact.de/phoenix/treeViewClick.do?UID=1860728>

Header, Nominal current: 8 A, Rated voltage (III/2): 160 V, Number of positions: 10, Pitch: 3.81 mm, Color: green, Metal surface: Sn, Assembly: Press-in

Commercial data

| | |
|--------------------------|---|
| GTIN (EAN) |  |
| sales group | E105 |
| Pack | 50 pcs. |
| Customs tariff | 85366990 |
| Catalog page information | Page 173 (CC-2009) |

Product notes

WEEE/RoHS-compliant since:
01/01/2003



<http://www.download.phoenixcontact.com>
Please note that the data given here has been taken from the online catalog. For comprehensive information and data, please refer to the user documentation. The General Terms and Conditions of Use apply to Internet downloads.

Technical data**Dimensions / positions**

| | |
|---------------------|----------|
| Length | 7.25 mm |
| Pitch | 3.81 mm |
| Dimension a | 34.29 mm |
| Number of positions | 10 |

| | |
|----------------|--------------|
| Pin dimensions | 0,8 x 0,8 mm |
| Hole diameter | 1.45 mm |

Technical data

| | |
|-------------------------------------|---------------|
| Range of articles | EMCV 1,5/..-G |
| Insulating material group | IIIa |
| Rated surge voltage (III/3) | 2.5 kV |
| Rated surge voltage (III/2) | 2.5 kV |
| Rated surge voltage (II/2) | 2.5 kV |
| Rated voltage (III/2) | 160 V |
| Rated voltage (II/2) | 250 V |
| Connection in acc. with standard | EN-VDE |
| Nominal current I_N | 8 A |
| Nominal voltage U_N | 160 V |
| Maximum load current | 8 A |
| Insulating material | PBT |
| Inflammability class acc. to UL 94 | V0 |
| Nominal voltage, UL/CUL Use Group B | 300 V |
| Nominal current, UL/CUL Use Group B | 8 A |
| Nominal voltage, UL/CUL Use Group D | 300 V |
| Nominal current, UL/CUL Use Group D | 8 A |

Certificates / Approvals



Certification

CUL, GOST, UL

Accessories

| Item | Designation | Description |
|-----------------|---------------|--|
| Assembly | | |
| 1877258 | EMC 1,5-SH | Stamp holder, for upper and lower stamp |
| 1877274 | EMCV 1,5-SS 1 | Stamp set, consisting of upper and lower stamp for 3.81 mm pitch, 2 to 16-pos. |

Marking

| | | |
|---------|--------------------------|--|
| 0804109 | SK 3,81/2,8:FORTL.ZAHLEN | Marker card, printed horizontally, self-adhesive, 10-section marker strip, 14 identical decades marked 1-10, 11-20 etc. up to 91-(99)100, sufficient for 140 terminal blocks |
|---------|--------------------------|--|

Plug/Adapter

| | | |
|---------|---------|---|
| 1734634 | CP-MSTB | Keying profile, is inserted into the slot on the plug or inverted header, red insulating material |
|---------|---------|---|

Additional products

| Item | Designation | Description |
|----------------|-------------------------|---|
| General | | |
| 1851122 | FK-MCP 1,5/10-ST-3,81 | Plug component, Nominal current: 8 A, Rated voltage (III/2): 160 V, Number of positions: 10, Pitch: 3.81 mm, Color: green, Metal surface: Sn |
| 1850741 | FRONT-MC 1,5/10-ST-3,81 | Plug component, Nominal current: 8 A, Rated voltage (III/2): 160 V, Number of positions: 10, Pitch: 3.81 mm, Color: green, Metal surface: Sn |
| 1862658 | IMC 1,5/10-G-3,81 | Header, Nominal current: 8 A, Rated voltage (III/2): 160 V, Number of positions: 10, Pitch: 3.81 mm, Color: green, Metal surface: Sn, Assembly: Soldering |
| 1875506 | IMCV 1,5/10-G-3,81 | Header, Nominal current: 8 A, Rated voltage (III/2): 160 V, Number of positions: 10, Pitch: 3.81 mm, Color: green, Metal surface: Sn, Assembly: Soldering |
| 1803659 | MC 1,5/10-ST-3,81 | Plug component, Nominal current: 8 A, Rated voltage (III/2): 160 V, Number of positions: 10, Pitch: 3.81 mm, Color: green, Metal surface: Sn |
| 1852257 | MCC 1/10-STZ-3,81 | Plug component, Nominal current: 8 A, Rated voltage (III/2): 160 V, Number of positions: 10, Pitch: 3.81 mm, Color: green, Metal surface: Sn, Corresponding female crimp contacts with current [A] and conductor cross section range [mm ²] data: 5A/MCC-MT 0,2-0,35 (1859988); 8A/MCC-MT 0,5-1,0 (1859991) |
| 1827208 | MCVR 1,5/10-ST-3,81 | Plug component, Nominal current: 8 A, Rated voltage (III/2): 160 V, Number of positions: 10, Pitch: 3.81 mm, Color: green, Metal surface: Sn |
| 1827059 | MCVW 1,5/10-ST-3,81 | Plug component, Nominal current: 8 A, Rated voltage (III/2): 160 V, Number of positions: 10, Pitch: 3.81 mm, Color: green, Metal surface: Sn |
| 1897474 | QC 0,5/10-ST-3,81 | Plug component, Nominal current: 6 A, Rated voltage (III/2): 200 V, Number of positions: 10, Pitch: 3.81 mm, Color: green, Metal surface: Sn |

Diagrams/Drawings

Drilling plan/solder pad geometry

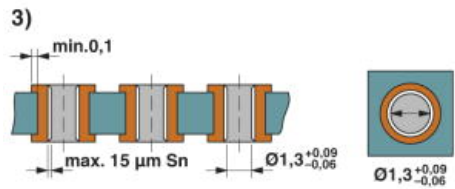
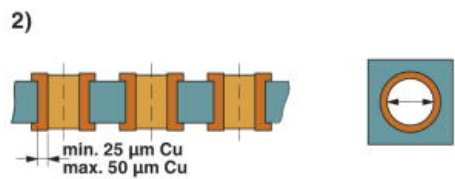
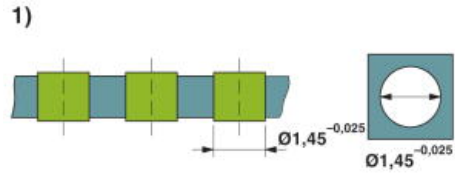
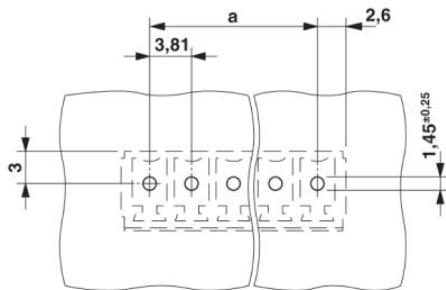

Drill hole layout in FR4 or EP-GC basic material

Dimensioned drawing

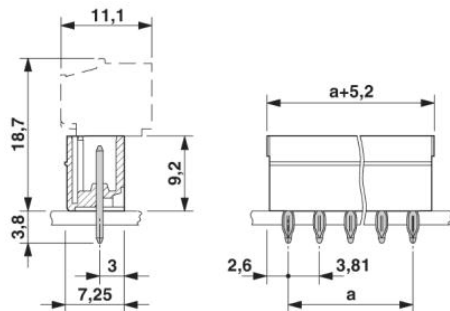

Address

PHOENIX CONTACT Deutschland GmbH
Flachmarktstr. 8
32825 Blomberg, Germany
Phone +49 5235 3 12000
Fax +49 5235 3 41200
<http://www.phoenixcontact.de>



© 2010 Phoenix Contact
Technical modifications reserved;