

NOTES

MATERIAL - DIECAST ALUMINUM ALLOY
 - FOUR M12 CAPTIVE SCREWS

POWDER COATED- Col. RAL 7032
 GASKET - POLYURATHANE
 -40°C TO +80°C TEMP. RANGE

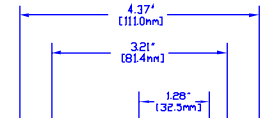
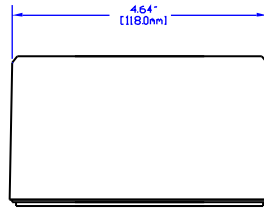

1.28" (32.3mm)

M6 thread

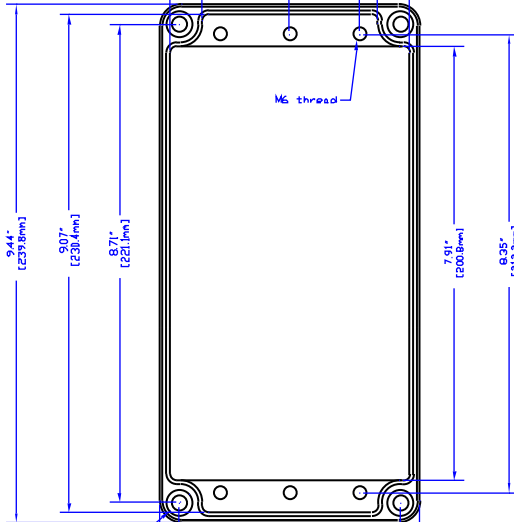
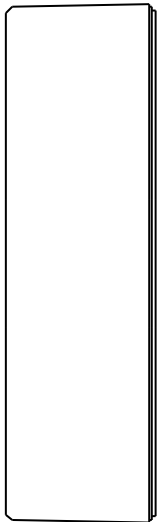

Ø0.47" (Ø12.0mm)

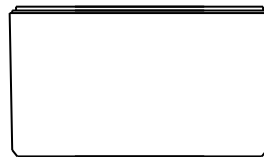

VIEW OF BOX (LID REMOVED)

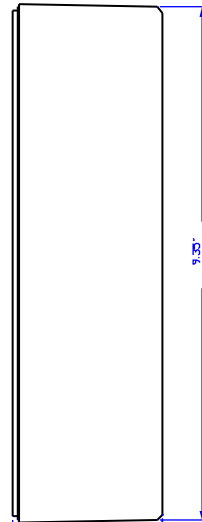

2.61" (66.2mm)
 5.64" (143.1mm)
 2.72" (69.2mm)

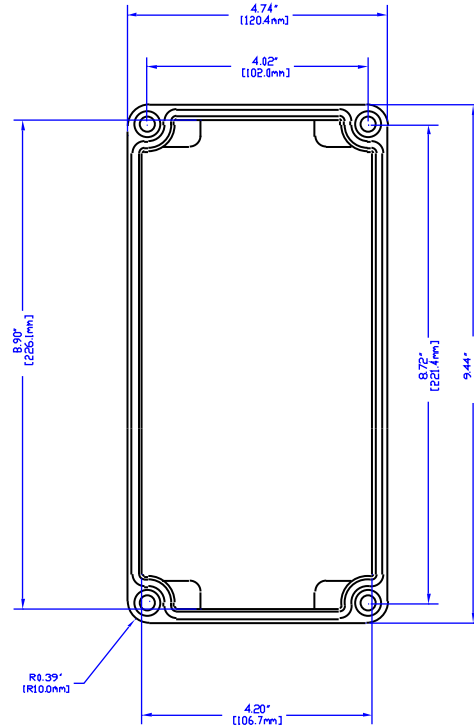

VIEW OF LID (INSIDE)



1.36" (33.0mm)



HAMMOND MANUFACTURING

R100-124-000

CANADA - PH (519) 886 7170 - FAX (519) 886 8311
 U.S.A. - PH (716) 631 5700 - FAX (716) 631 1156