



BlackFin™ Installation Tools

BlackFin®

PANDUIT®
infrastructure for a connected world

Meets OSHA Mandated Electrical and Mechanical Product Safety Requirements

- Certified by CSA, an OSHA accredited NRTL (nationally recognized test lab) to meet mandatory OSHA requirements
- Meets requirements of Safety for Handheld, Motor-Operated Electric Tools (UL 60745-1, CSA C22.2 No 60745-1)
- Prevention of fire, shock, mechanical, noise hazards to workers

Meets requirements of EU Machinery Directive and EMC Directive

- Certified by SiQ to IEC/EN 62841-1
- Safety of Electric Motor-Operated Magnetically Driven Hand Tools
- Tested to EN 61000 series
- Electromagnetic Compatibility Environment

Meets ISO 12100, Machinery Safety Risk Assessment, including ergonomics

Tools That Lead the Industry in Safety and Reliability



In-Line Tool Designs
mitigate motion wrist injuries



Weight Forward Handle Design
provides balanced operation for
pistol grip tools



Soft composite **No-Slip Grips**
provide secure and comfortable
tool operation



Quick Motor Stop upon release of
activation trigger prevents damage
to components or operator



Audible and Visual LED Warning
signals when crimping operation
is complete



Rotating Crimp Head designs
facilitate ease of tool operations in
constrained spaces



Auto Piston Retraction provides
visual verification that crimp cycle
is complete



LED Signal Light notifies when
tool requires maintenance to extend
life of the tool

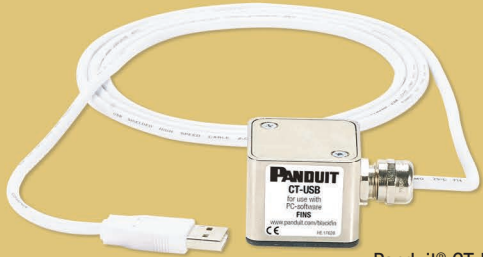

Panduit® CT-USB accessory

FINs - Fast and Intelligent Notification Software

Statistical documentation and evaluation of crimping process world

Simple and Easy to Use Home Screen for: Project Tracking and Status, Operations Log, Service Reports

Key Performance Metrics:

- Number of cycles
- Last maintenance
- Project status
- Quality Control Documents: Service log and Test Certificate
- Waveform Crimp Performance

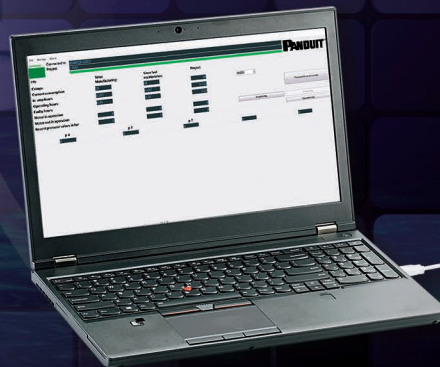



What is FINS - Panduit's Fast and Intelligent Notification Software

- Statistical performance of all cycles, integrity of operation and other tool metrics

Detailed Work History

- Download, print, and store work information such as operating pressure, number of crimps/cuts, and battery information

Accountability

- Prove that the job was done correctly with operation and project specific documentation

Diagnostics

- Set and view maintenance intervals and add user identifiable information to manage your inventory

1. Download FIN software from www.panduit.com/blackfin
2. Connect CT-USB to your computer
3. Open Panduit FIN Software
4. Place FIN infrared indicator on tool optical interface; pull trigger

Operation Log

- Printable performance overview
- Differentiate your workforce with accountability

BlackFin™ Tool Performance Interface

- Home navigation screen for waveforms, project start, project log, and operation log project specific documentation
- Three key measurables; number of cycles since manufacture, last maintenance, and project
- Service interval level with grace period setting
- Shows recent pressure values in PSI

Waveform: Real Time Assurance

- View battery information and nominal PSI performance in real time

Description

- 3 phase operation log for tracking tool output
- PDF downloadable work history
- Programmable service intervals
- Waveform - real time pressure and amperage monitoring
- Low pressure incident detail
- Inventory management /tool identification capabilities
- Windows based

CT-3001/ST

Battery Powered Crimping Tool

The CT-3001/ST has a slim crimping head which makes it ideal when space is critical. **The Automatic Position Control** makes it easy for multiple crimp needs.

Low profile, flip-top, crimp head, rotates 350 degrees

Crimping force
6.7 tons (60kN)

One push-button operation

Soft rubber inlay comfort grips

LED worklight

Automatic piston retraction to signal complete crimp

Automatic position control locks out piston retraction stop to save battery life

Integrated pressure measurement System provides visual and audible signals if full crimp force is not attained

Ergonomic, low profile, in-line design

Tool function readout via infrared sensor and optional CT-USB adapter

Powerful 18 vdc Makita Li-ion batteries with fast 22 minute recharge time



Technical Data

CT-3001/ST

Crimping force	6.7 tons (60 kN)
Stroke/Opening width	0.69 inches (17.5 mm)
Crimping range	#8 AWG - 600 kcmil Cu. Code #8 AWG - 373 kcmil Cu. Flex #6 AWG - 350 kcmil Al 10 mm ² - 95 mm ² Cu. Class 5f & 6f metric #1/0 AWG - 500 kcmil ferrules
Crimping cycle	2 s (for ARS) to 5 s (depending on cross-section)
Number of crimps	Approx. 300 at 300 kcmil (150 mm ²) Cu

Battery voltage	18 V
Battery capacity	3.0 Ah, Li-ion
Charging time	22 min
Weight incl. battery	6.6 lbs. (3.0 kg)
Ambient temperature	14°F - 104° F (-10°C to +40°C)

Ordering Information

- CT-3001/ST** USA Type A plug version. 6.7 ton battery powered crimping tool with two 3.0 Ah Makita Li-ion batteries, 120V charger and incl. CD-2001 die adapter CD-3001/ST-DA.
- CT-3001/STINT** EU Type C plug version. 6.7 ton battery powered crimping tool with two 3.0 Ah Makita Li-ion batteries, EU 230 vac charger and CD-2001 die adapter CD-3001/ST-DA.
- CT-3001/STUK** UK Type G plug version. 6.7 ton battery powered crimping tool with two 3.0 Ah Makita Li-ion batteries, British 230 vac charger and CD-2001 die adapter CD-3001/ST-DA.
- CT-3001/STAUS** AUS Type I plug version. 6.7 ton battery powered crimping tool with two 3.0 Ah Makita Li-ion batteries, Australian 230 vac charger and CD-2001 die adapter CD-3001/ST-DA.
- CT-3001/TO** Bare 6.7 ton battery powered crimping tool with CD-2001 die adapter CD-3001/ST-DA. No battery, no battery charger and no case.



Accessories



Battery



Charger



Case

CT-3980

Uni-Die™ Dieless Crimp Tool

The innovative dieless CT-3980 creates an effortless operation - **No die changing required** which increases user efficiency – Who wouldn't want that on the job site?

Low profile, flip-top, crimp head, rotates 350 degrees

2-Stage telescopic indenter, crimping pressure monitored 32X/sec. to provide correct crimp force

One push-button operation

Soft rubber inlay comfort grips

LED worklight

Crimping force 3.4 to 6.7 tons (30-60 kN)

Automatic piston retraction to signal complete crimp

Manual retraction stop with "teach in" feature to set position of piston stop

Integrated pressure measurement System provides visual and audible signals if full crimp force is not attained

Ergonomic, low profile, in-line design

Tool function readout via infrared sensor and optional CT-USB adapter

Powerful 18 vdc Makita Li-ion batteries with fast 22 minute recharge time



Technical Data

CT-3980

Crimping force	3.4 to 6.7 tons (30 - 60 kN)
Stroke/Opening width	1.4 inches (35.5 mm)
Crimping range	#8 AWG - 600 kcmil Cu. Code #8 AWG - 373 kcmil Cu. Flex #6 AWG - 350 kcmil Al
Crimping cycle	2 s (for ARS) to 7 s (depending on cross section)
Number of crimps	Approx. 300 at 300 kcmil (150 mm ²) Cu

Battery voltage	18 V
Battery capacity	3Ah, Li-ion
Charging time	22 min
Weight incl. battery	5.5 lbs. (2.5 kg)
Ambient temperature	14°F - 104°F (-10°C to +40°C)

Ordering Information

- CT-3980** USA Type A plug version. Uni-Die™ 3.4 - 6.7 ton battery powered dieless indenter crimping tool with two 3.0 Ah Makita Li-ion batteries, 120V charger.
- CT-3980/INT** EU Type C plug version. Uni-Die™ 3.4 - 6.7 ton battery powered dieless indenter crimping tool with two 3.0 Ah Makita Li-ion batteries, EU 230 vac charger.
- CT-3980/UK** UK Type G plug version. Uni-Die™ 3.4 - 6.7 ton battery powered dieless indenter crimping tool with two 3.0 Ah Makita Li-ion batteries, British 230 vac charger.
- CT-3980/AUS** AUS Type I plug version. Uni-Die™ 3.4 - 6.7 ton battery powered dieless indenter crimping tool with two 3.0 Ah Makita Li-ion batteries, Australian 230 vac charger.
- CT-3980/TO** Bare Uni-Die™ 3.4 - 6.7 ton battery powered dieless indenter crimping tool. No battery charger, no case.

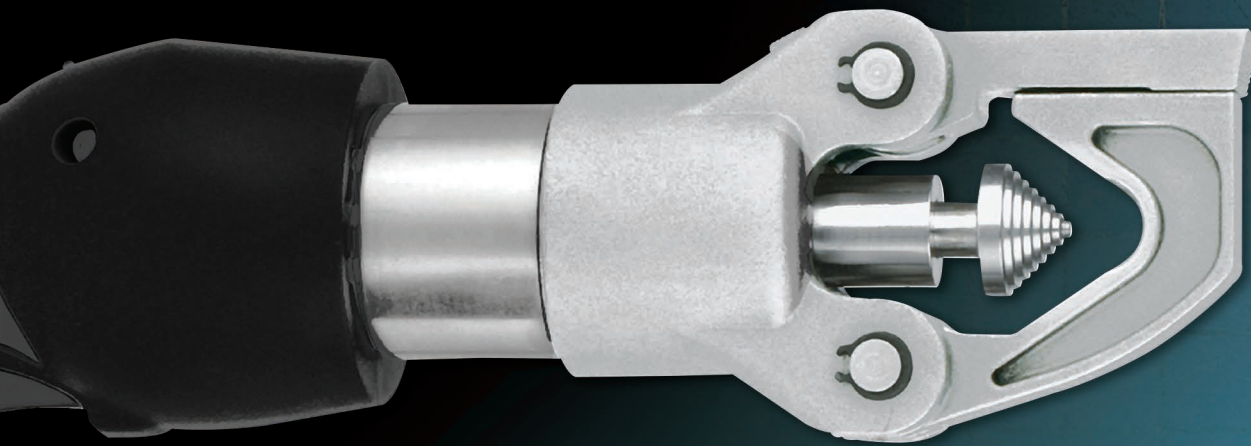

Accessories



Battery



Charger



Case

CT-3001/CCP

3 in 1: Crimping, Cutting, Punching

The CT-3001/CCP is a universal tool design that operates using crimp dies, cutting blades and hole punch adapters. This low profile design has **ergonomic 2-component plastic housing** with soft inlays for comfortable and safe one-hand operation.

Universal tool design operates using crimp dies, wire and threaded rod cutting blades and hole punch adapter

Low profile, flip-top crimp head, rotates 350 degrees

One push-button operation

Soft rubber inlay comfort grips

LED worklight

Crimping force 6.7 tons (60 kN)

Automatic piston retraction to signal complete crimp

Manual retraction stop with "teach in" feature to set position of piston stop

Ergonomic, low profile, in-line design

Tool function readout via infrared sensor and optional CT-USB adapter

Powerful 18 vdc Makita Li-ion batteries with fast 22 minute recharge time



Technical Data

CT-3001/CCP

Crimping force	6.7 tons (60 kN)
Stroke/Opening width	1.06 inches (27 mm)
Crimping range	#8 AWG - 600 kcmil Cu. Code #8 AWG - 373 kcmil Cu. Flex #6 AWG - 350 kcmil Al 10mm ² - 240 mm ² Cu Class 2 metric 10 mm ² - 95 mm ² Cu. Class 5f & 6f metric #1/0 AWG - 500 kcmil ferrules
Crimping cycle	7 s to 9 s (depending on cross-section)
Number of crimps	Approx. 300 at 300 kcmil (150 mm ²) Cu

Cutting Range	Max. 1" (25mm) dia. copper and aluminum cable. Soft threaded rod, ACSR, ACAR, standard guy wire, EHS guy wire, copperweld, ground rod, anchor rod, soft bolts, rebar
Punching capacity	Can drive punches up to 2" (50 mm) dia. conduit size in 10 ga. mild steel using Panduit CD-2001-PDA adapter
Battery voltage	18 V
Battery capacity	3Ah, Li-Ion
Charging time	22 min
Weight with battery	6.6 lbs. (3.0 kg)
Ambient temperature	14°F - 104°F (-10°C to +40°C)

Ordering Information

CT-3001/CCP	USA Type A plug version. Includes; 6.7 ton battery powered dieless indenter crimping tool with two 3.0 Ah Makita Li-ion batteries, 120V charger and CD-2001 die adapter.
CT-3001/CCPINT	EU Type C plug version. Includes; 6.7 ton battery powered crimping tool with two 3.0 Ah Makita Li-ion batteries, EU 230 vac charger and CD-2001 die adapter.
CT-3001/CCPUK	UK Type G plug version. Includes; 6.7 ton battery powered crimping tool with two 3.0 Ah Makita Li-ion batteries, British 230 vac charger and CD-2001 die adapter.
CT-3001/CCPAUS	AUS Type I plug version. Includes; 6.7 ton battery powered crimping tool with two 3.0 Ah Makita Li-ion batteries, Australian 230 vac charger and CD-2001 die adapter.
CT-3001/CCPTO	Bare 6.7 ton battery powered crimping tool with CD-2001 die adapter. No battery, no battery charger and no case.

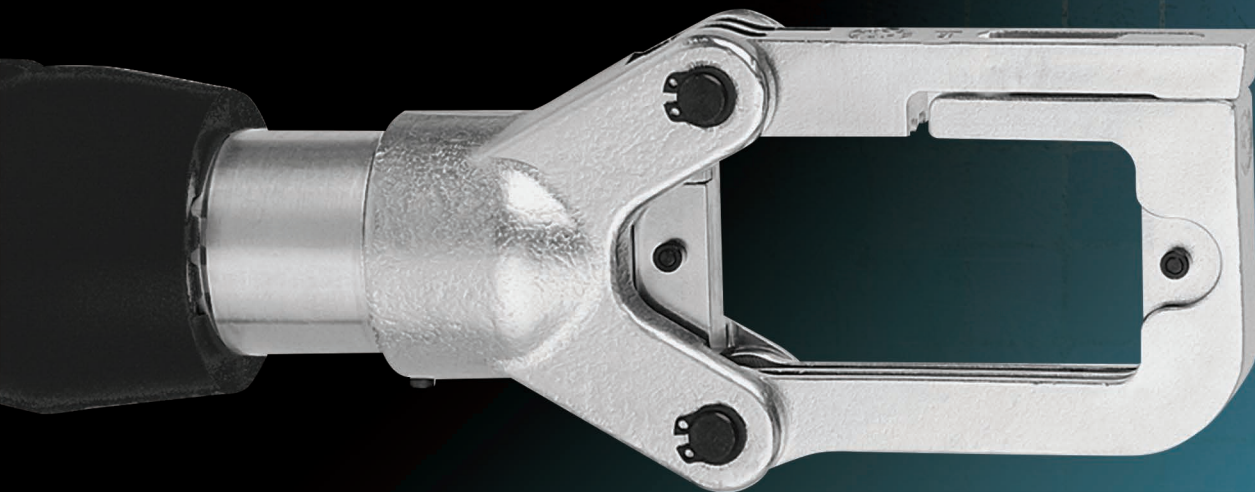

Accessories



Battery



Charger



Case

CT-2920/CCP

3 in 1: Crimping, Cutting, Punching



Crimping force
12 tons (108kN)

Universal tool design operates
using crimp dies, wire and
threaded rod cutting blades
and hole punch adapter

Automatic piston
retraction to
signal complete
crimp

Manual retraction stop
with "teach in" feature to
set position of piston stop

This battery operated tool is a **convenient 3 in 1**. Interchangeable adapters and dies are available to crimp, cut and punch. When time and space is critical the CT-2920/CCP is the best option.

Low profile, flip-top
crimp head, rotates
350 degrees

LED worklight

One push-button
operation

Soft rubber inlay
comfort grips

Tool function readout via infrared
sensor and optional CT-USB adapter

Powerful 18 vdc Makita Li-ion
batteries with fast 22 minute
recharge time

Makita 18V 3.0Ah
LITHIUM-ION

Technical Data

CT-2920/CCP

Crimping force	12 tons (108 kN)
Stroke/Opening width	1.65 inches (42 mm)
Crimping range	#8 AWG - 750 kcmil Cu. Code #8 AWG - 535 kcmil Cu. Flex #6 AWG - 600 kcmil Al 10mm ² - 400 mm ² Cu Class 2 metric 10 mm ² - 300 mm ² Cu. Class 5f & 6f metric #10 AWG - 500 kcmil ferrules 1/0 AWG
Crimping cycle	7 s - 9 s (depending on cross-section)
Number of Crimps	Approx. 110 crimps on 300 kcmil (150 mm) copper code lug

Cutting Range	Max. 1.5" (40mm) dia. copper and aluminum cable, 954 kcmil (Cardinal) ACSR, 5/8" dia. standard Guy strand, 1/2" dia. EHS Guy Strand, Ground Rod, and Rebar (schedule 60), 1/4", 3/8" and 1/2" dia. threaded rod
Punching capacity	Can drive punches 5-5/8" (144mm) diameter round in 10 ga. mild steel with Panduit CD-920-PDA punch driver adapter accessory
Battery voltage	18 V
Battery capacity	3 Ah, Li-ion
Charging time	22 min
Weight	14.33 lbs. (6.5 kg)
Ambient temperature	14°F - 104°F (-10°C to +40°C)

Ordering Information

- CT-2920/CCP** USA Type A plug version. Includes; 12 ton battery powered crimping tool, with two 3.0 Ah Makita Li-ion batteries, 120V Charger and adapter for CD-920/930 dies. Comes with carrying strap.
- CT-2920/CCPINT** EU Type C plug version. Includes; 12 ton battery powered crimping tool, with two 3.0 Ah Makita Li-ion batteries, EU 230 vac charger and adapter for CD-920/930 dies. Comes with carrying strap.
- CT-2920/CCPUK** UK Type G plug version. Includes; 12 ton battery powered crimping tool, with two 3.0 Ah Makita Li-ion batteries, British 230 vac charger and adapter for CD-920/930 dies. Comes with carrying strap.
- CT-2920/CCPAUS** AUS Type I plug version. Includes; 12 ton battery powered crimping tool, with two 3.0 Ah Makita Li-ion batteries, Australian 230 vac charger and adapter for CD-920/930 dies. Comes with carrying strap.
- CT-2920/CCPTO** Bare 12 ton battery powered crimping tool and battery charger for CD-920/930 dies. No battery, no adapters and no case.

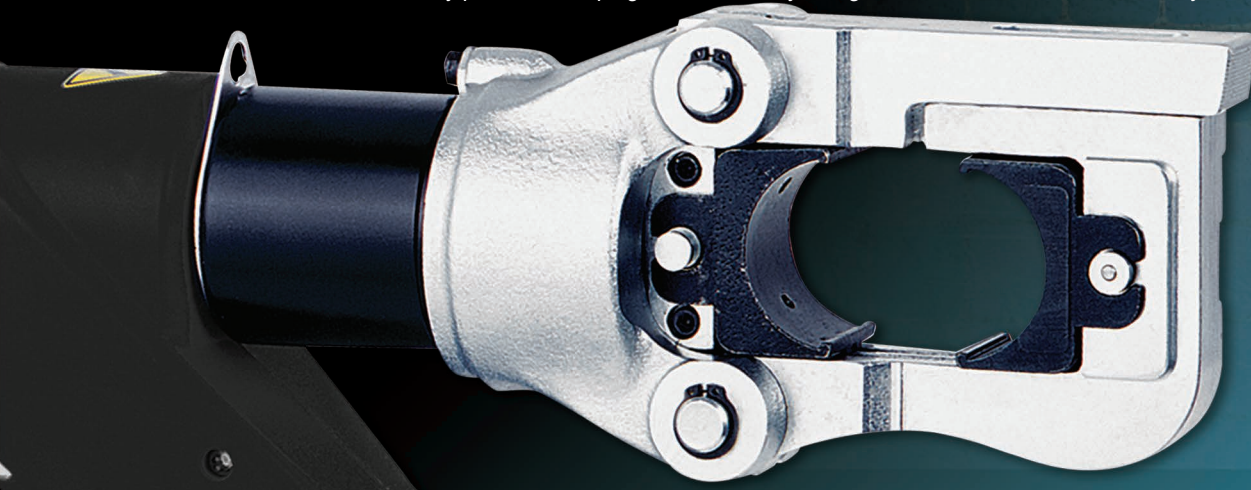

Accessories



Battery



Charger



Case

CT-2931/ST

Crimp head rotates 350 degree. Model is also available with 2-layer PVC insulation

Open C-Head design allows easy placement of connectors in tool

Automatic piston retraction to signal complete crimp

Automatic position control locks out piston retraction stop to save battery life

When safety is critical, there is no other alternative to the CT-2931/ST. This tool has a **quick motor stop for high user safety** along with automatic retraction when crimping is complete. There is also an integrated pressure measurement with a visual and audible signal if full crimp force is not attained.

LED worklight

Integrated pressure measurement System provides visual and audible signals if full crimp force is not attained

One push-button operation

Tool function readout via infrared sensor and optional CT-USB adapter

Soft rubber inlay comfort grips

Powerful 18 vdc Makita Li-ion batteries with fast 22 minute recharge time

Makita® 18V 3.0Ah Li-ion LITHIUM-ION

Technical Data

CT-2931/ST

Crimping force	12 tons (108 kN)
Stroke/Opening width	1.65 inches (42 mm)
Crimping range	#8 AWG - 750 kcmil Cu. Code #8 AWG - 535 kcmil Cu. Flex #6 AWG - 600 kcmil Al 10mm ² - 400 mm ² Cu Class 2 metric 10 mm ² - 300 mm ² Cu. Class 5f & 6f metric
Crimping cycle	8 s to 9 s (depending on cross-section)
Number of crimps	Approx. 115 at 300 kcmil (150 mm ²) Cu

Battery voltage	18 V
Battery capacity	3Ah, Li-ion
Charging time	22 min
Weight incl. battery	15.0 lbs. (6.8 kg)
Ambient temperature	14°F - 104°F (-10°C to +40°C)

Ordering Information

CT-2931/ST	12 ton (108kN) battery powered crimping tool, 1.65" opening with two 3.0 Ah Makita Li-ion batteries, 120V charger. Comes with carrying strap.	CT-2931/STCV	US. 2 layer PVC covered crimp head.
CT-2931/STINT	12 ton (108kN) battery powered crimping tool, 1.65" opening with two 3.0 Ah Makita Li-ion batteries, EU 230 vac charger. Comes with carrying strap.	CT-2931/STCVINT	EU. 2 layer PVC covered crimp head.
CT-2931/STUK	12 ton (108kN) battery powered crimping tool, 1.65" opening with two 3.0 Ah Makita Li-ion batteries, British 230 vac charger. Comes with carrying strap.	CT-2931/STCVUK	UK. 2 layer PVC covered crimp head.
CT-2931/ST AUS	12 ton (108kN) battery powered crimping tool, 1.65" opening with two 3.0 Ah Makita Li-ion batteries, Australian 230 vac charger. Comes with carrying strap.	CT-2931/STCV AUS	AUS. 2 layer PVC covered crimp head.
CT-2931/TO	Bare 12 ton (108kN) battery powered crimping tool, 1.65" opening. No battery, no battery charger and no case.	CT-2931/CVTO	Tool only with 2 layer PVC covered crimp head.



Accessories



Battery



Charger



Case

CT-2940/ST



Open C-Head design allows easy placement of connectors in tool

Automatic piston retraction to signal complete crimp

Automatic position control locks out piston retraction stop to save battery life

Crimp head rotates 350 degrees

The CT-2940/ST has automatic position control and the crimp head rotates 350 degrees which makes it easy to crimp in multiple positions.
– **Versatility at its finest.**

Integrated pressure measurement System provides visual and audible signals if full crimp force is not attained

Support handle can be mounted to either side of crimp head

Tool function readout via infrared sensor and optional CT-USB adapter

Soft rubber inlay comfort grips

Powerful 18 vdc Makita Li-ion batteries with fast 22 minute recharge time

Technical Data

CT-2940/ST

Crimping force 15 tons (135 kN)

Crimping range #8 AWG - 1,000 kcmil Cu. Code
#8 AWG - 777.7 kcmil Cu. Flex
#6 AWG - 1,000 kcmil Al.
10mm² - 630 mm² Metric Class 2r metric
10 mm² - 300 mm² Metric Class 5f & 6f metric

Crimping cycle 6 s - 9 s. & Number of Crimps Approx. 50 crimps on 300 kcmil (150 mm²) copper code lug

Battery voltage 18 V

Battery capacity 3Ah, Li-ion

Charging time 22 mins.

Weight 19 lbs. (8.5 KG)

Ordering Information

CT-2940/ST USA Type A plug version. Includes; 15 ton battery powered crimping tool, with two 3.0 Ah Makita Li-ion batteries, 120V Charger and adapter for CD-940 dies. Comes with carrying strap.

CT-2940/STINT EU Type C plug version. Includes; 15 ton battery powered crimping tool, with two 3.0 Ah Makita Li-ion batteries, EU 230 vac charger and adapter for CD-940 dies. Comes with carrying strap.

CT-2940/STUK UK Type G plug version. Includes; 15 ton battery powered crimping tool, with two 3.0 Ah Makita Li-ion batteries, British 230 vac charger and adapter for CD-940 dies. Comes with carrying strap.

CT-2940/STAUS AUS Type I plug version. Includes; 15 ton battery powered crimping tool, with two 3.0 Ah Makita Li-ion batteries, Australian 230 vac charger and adapter for CD-940 dies. Comes with carrying strap.

CT-2940/TO Bare 15 ton battery powered crimping tool with die adapter for CD-940 dies. No battery, no battery charger and no case.

Accessories

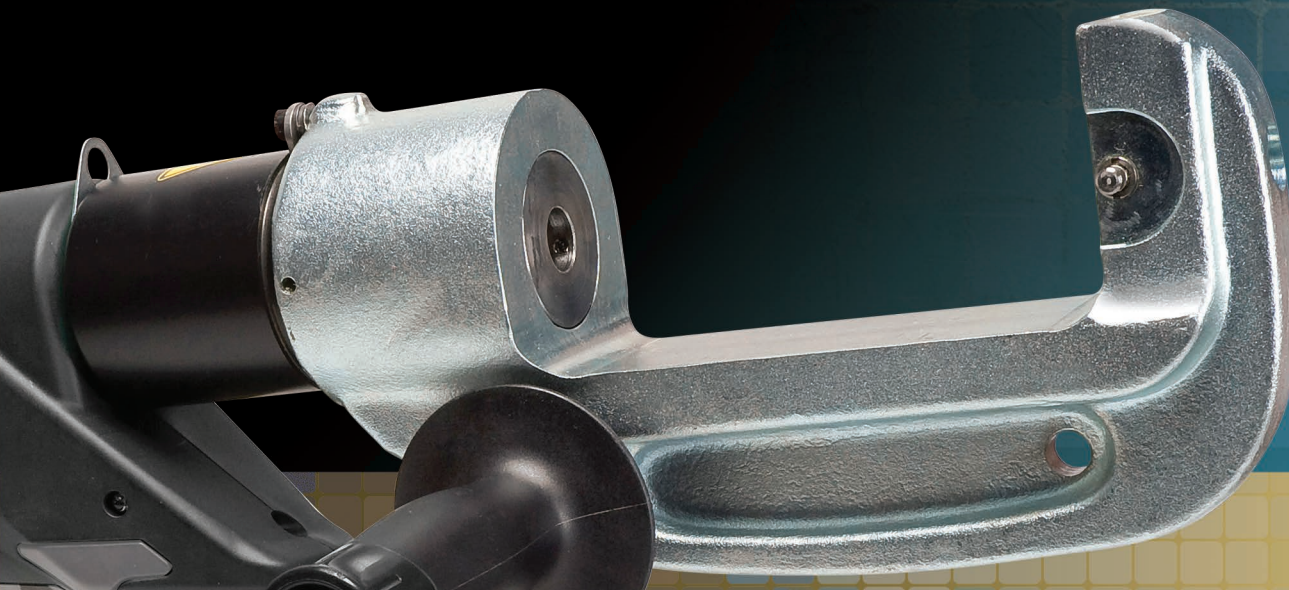

Battery



Charger



Case

CT-2980/ST

Uni-Die™ Dieless Crimp Tool

Ergonomic 2-component plastic housing with soft inlays for comfortable and safe one-hand operation. Creating effortless operation over long periods of time.



Light weight aluminum alloy crimp head with flip open top to accommodate splices

Automatic piston retraction to signal complete crimp

Automatic position control locks out piston retraction stop to save battery life

Crimp head rotates 360 degrees

One push-button operation

Soft rubber inlay comfort grips

Integrated pressure measurement system provides visual and audible signals for crimping errors

Tool function readout via infrared sensor and optional CT-USB adapter

Powerful 18 vdc Makita Li-ion batteries with fast 22 minute recharge time

Makita 18V 3.0Ah LITHIUM-ION

Technical Data

CT-2980/ST

Crimping force	6.2 tons (55 kN)
Crimping range	#8 AWG - 750 kcmil Cu. Code #4 AWG - 500 kcmil Al.
Crimping cycle	3 s to 6 s (depending on cross-section)
Number of crimps	Approx. 300 at 300 kcmil (150 mm ²) Cu. Code

Battery voltage	18 V
Battery capacity	3.0 Ah, Li-ion
Charging time	22 mins.
Weight incl. battery	10.8 lbs. (4.9 kg)
Ambient temperature	10.4°F - 104°F (-12°C to +40°C)

Ordering Information

- CT-2980/ST** USA Type A plug version. Includes; Uni-Die™ 6.2 ton Quad-Point battery powered tool, dieless, flip-top crimp head, with two 3.0 Ah Makita Li-ion batteries, 120V charger. Comes with carrying strap.
- CT-2980/STINT** EU Type C plug version. Includes; Uni-Die™ 6.2 ton Quad-Point battery powered tool, dieless, flip-top crimp head, with two 3.0 Ah Makita Li-ion batteries, EU 230 vac charger. Comes with carrying strap.
- CT-2980/STUK** UK Type G plug version. Includes; Uni-Die™ 6.2 ton Quad-Point battery powered tool, dieless, flip-top crimp head, with two 3.0 Ah Makita Li-ion batteries, British 230 vac charger. Comes with carrying strap.
- CT-2980/STAUS** AUS Type I plug version. Includes; Uni-Die™ 6.2 ton Quad-Point battery powered tool, dieless, flip-top crimp head, with two 3.0 Ah Makita Li-ion batteries, Australian 230 vac charger. Comes with carrying strap.
- CT-2980/TO** Uni-Die™ 6.2 ton Quad-Point battery powered tool, flip-top head dieless. No battery, no battery charger and no case.



Accessories



Battery



Charger



Case

CT-2500/L

When quickness counts - the CT-2500/L has a quick 2-4 second crimping cycle - resulting in less time to crimp terminals when compared to conventional methods. **Quick release pins for fast changeover of Panduit crimp heads.**



Automatic piston retraction to signal complete crimp

One push-button operation

Soft rubber inlay comfort grips

LED worklight

Quick release pin for fast change over of Panduit crimp heads allows tool to crimps Panduit rings, forks, disconnects, splices and ferrules - Tool head and dies sold separately

Crimp head rotates 360 degrees

Integrated pressure measurement system provides visual and audible signals for crimping errors

Ergonomic, low profile, in-line design

Tool function readout via infrared sensor and optional CT-USB adapter

10.8 vdc 1.5 Ah Li-ion batteries with charge indicator

Technical Data

CT-2500/L

Crimping force	1.7 tons (15 kN)
Range	#22 – 10 AWG (0.05 – 6.0mm ²) insulated and non-insulated terminals, disconnects, and splices #26 - 6 AWG (0.14 - 16.0mm ²) insulated and non-insulated single wire ferrules #22 - 10 AWG (0.05 - 6.0mm ²) insulated twin ferrules
Crimping cycle	< 2 s (depending on connecting material)
Number of crimps	Approx. 300 crimps per battery charge cycle

Battery voltage	10.8 V
Battery capacity	1.5 Ah, Li-ion
Charging time	Approx. 15 min
Weight with battery	2.8 lbs. (1.28 kg)
Ambient temperature	14°F - 104°F (-10°C to 40°C)

Ordering Information

- CT-2500/L** USA Type A plug version. Includes; 1.7 ton battery powered crimping tool, with two 1.5 Ah, Li-ion batteries, 120V charger and molded carrying case. Crimp heads not included.
- CT-2500/LE** EU Type C plug version. Includes; 1.7 ton battery powered crimping tool, with two 1.5 Ah, Li-ion batteries, EU 230 vac charger and molded carrying case. Crimp heads not included.
- CT-2500/TO** No battery, no adapters and no case.

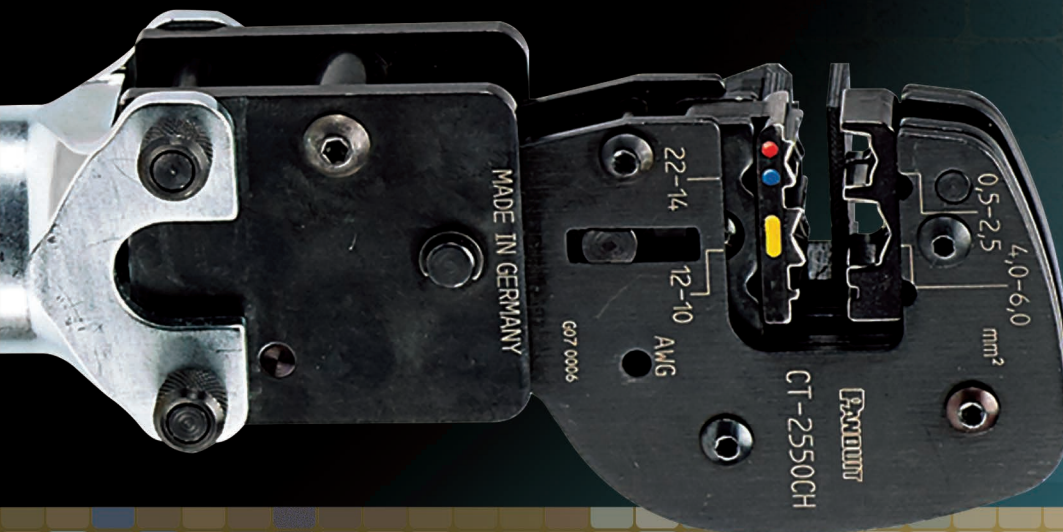

Accessories



Battery



Charger



Case

CT-2600/L

The CT-2600/L battery powered hydraulic design delivers quick termination of large wire insulated and non-insulated ring terminals. The one push-button operation controls all tooling functions which creates **easy handling with just one hand.**

Low profile, flip-top crimp head for quick die change over

Slim crimping head-ideal when space is critical

Crimp head rotates 360 degrees

One push-button operation

Soft rubber inlay comfort grips

LED worklight

Automatic piston retraction to signal complete crimp cycle

Integrated pressure measurement system provides visual and audible signals for crimping errors

Ergonomic, low profile, in-line design

Tool function readout via infrared sensor and optional CT-USB adapter

18 vdc 3 Ah Li-ion battery with charge indicator



Technical Data

CT-2600/L

Crimping force	4.0 tons, (35 kN)
Crimping range	#8 AWG - #2 AWG large insulated and non-insulated terminals and butt splices 8 AWG - 300 kcmil copper Code lugs, 6 AWG - 2/0 AWG Al lugs
Crimping cycle	< 4 s (depending on connecting material)
Number of crimps	Approx 400 crimps per battery charge cycle (2Ah)

Battery voltage	18 V
Battery capacity	2.0 Ah and 3.0 Ah Li-ion
Charging time	22 min.
Weight with battery	4 lbs. (1.8 kg)
Ambient temperature	14°F - 104°F (-10°C to +40°C)

Ordering Information

- CT-2600/L** USA Type A plug version. Includes; 4 ton battery powered crimping tool, with two 2.0 Ah Li-ion batteries, 120V charger, molded carrying case. Crimp dies not included.
- CT-2600/LINT** EU Type C plug version. Includes; 4 ton battery powered crimping tool, with two 3.0 Ah Li-ion batteries, EU 230 vac charger, molded carrying case. Crimp dies not included.
- CT-2600/LUK** UK Type G plug version. Includes; 4 ton battery powered crimping tool, with two 3.0 Ah Li-ion batteries, British 230 vac charger, molded carrying case. Crimp dies not included.
- CT-2600/LAUS** AUS Type I plug version. Includes; 4 ton battery powered crimping tool, with two 3.0 Ah Li-ion batteries, Australian 230 vac charger, molded carrying case. Crimp dies not included.
- CT-2600/TO** Bare 4 ton battery powered crimping tool. No battery, no adapters and no case.

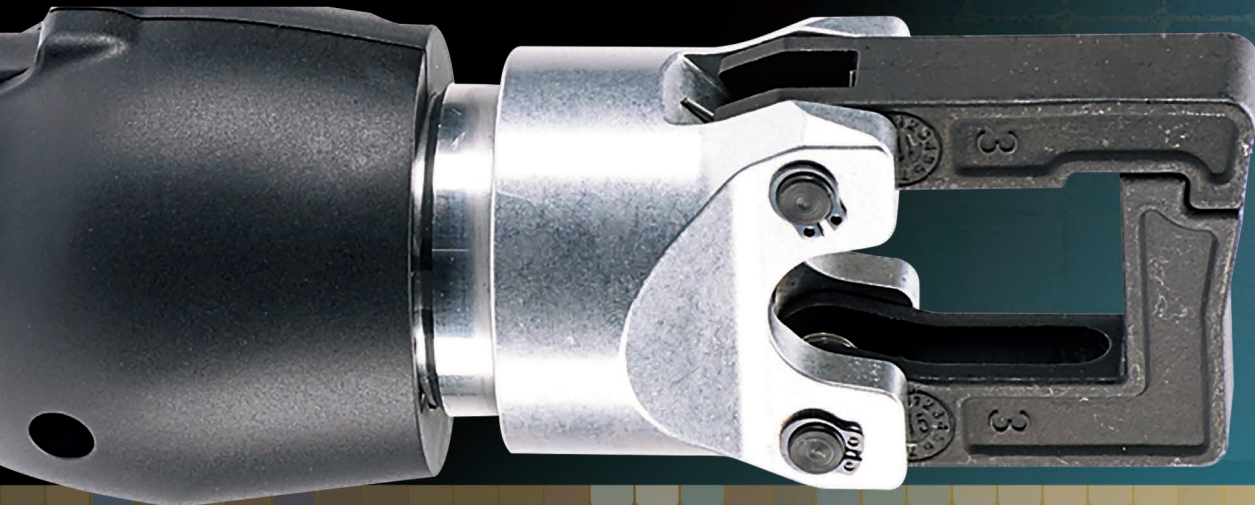

Accessories



Battery



Charger



Case

CT-2300/ST

The CT-2300/ST termination tool has a **65% faster crimping cycle vs. a manual crimping tool**. This compact, light-weight design reduces hand force from 53 pounds to 6 pounds – maximizing efficiency.

65% faster crimping cycle vs. manual crimping tools

Innovative trigger with Power Sensing Technology

Soft rubber inlay comfort grips

LED worklight

120mm Jaw accepts Panduit CD-525, CD-550, CD-570 and CD-090 Crimp Dies

Integrated pressure measurement system provides visual and audible signals for crimping errors

Ergonomic, low profile, in-line design

Tool function readout via infrared sensor and optional CT-USB adapter

10.8 vdc 1.5 Ah Li-ion batteries with charge indicator



Technical Data

CT-2300/ST

Crimping force	1.7 tons (15 kN)
Crimping range	#22 – 10 AWG terminals, disconnects, splices #26 – 10 AWG (0.14 – 6.0mm ²) singles wire ferrules #22 – 12 AWG (0.05 – 4.0mm ²) twin wire ferrules #14 AWG - 10 AWG copper lugs
Crimping cycle	<1.5 s (depending on connecting material)
Number of crimps	Approx. 300 at 10 mm ² Cu DIN 46234/per battery charge Approx 750 crimps per battery charge cycle (depending on connecting materials)

Battery voltage	10.8 V
Battery capacity	1.5 Ah, Li-ion
Charging time	Approx. 15 min
Weight with battery	2.11 lbs. (0.96 kg)
Ambient temperature	14°F - 104°F (-10°C to 40°C)

Ordering Information

- CT-2300/ST** USA Type A plug version. Includes; Battery powered micro-crimping tool, with one 1.5 Ah Li-ion batteries, charger. Crimp Dies not included.
- CT-2300/INT** EU Type C plug version. Includes; Battery powered micro-crimping tool, with one 1.5 Ah Li-ion batteries, 230 vac charger. Crimp Dies not included.
- CT-2300/UK** UK Type G plug version. Includes; Battery powered micro-crimping tool, with one 1.5 Ah Li-ion batteries, British 230 vac charger. Crimp Dies not included.
- CT-2300/AUS** AUS Type I plug version. Includes; Battery powered micro-crimping tool, with one 1.5 Ah Li-ion batteries, Australian 230 vac charger. Crimp Dies not included.
- CT-2300/TO** Bare battery powered micro-crimping tool. No battery, no adapters and no case.



Accessories



Battery



Charger



Case

CT-980

Uni-Die™ Dieless Crimp Tool

The high quality aluminum housing creates a **light weight design that is easy for the user to operate.**

This dieless tool can crimp copper code conductor and aluminum lugs. Also has wire range taking capability.

Light weight aluminum alloy crimp head with flip open top to accommodate splices

Crimp head rotates 360 degrees

Light weight aluminum design weighs 9 lbs.

Soft rubber inlay comfort grips



Automatic piston retraction to signal complete crimp

2 Stage rapid advance hydraulic system with double action pump handle reduces number of pumps to make a crimp

Technical Data

CT-980

Crimping force	6.2 tons, (55 kN)
Cutting range	#4 AWG - 750 kcmil Cu. Code #4 AWG - 500 kcmil Al.
Length	21 inches, (535mm)
Weight	9 lbs. (4.1 kg)
Ambient temperature	14°F - 104°F (-10°C to +40°C)

Ordering Information

CT-980 Uni-Die™ Dieless Manual Hydraulic 6.2 Ton Global Crimping Tool.

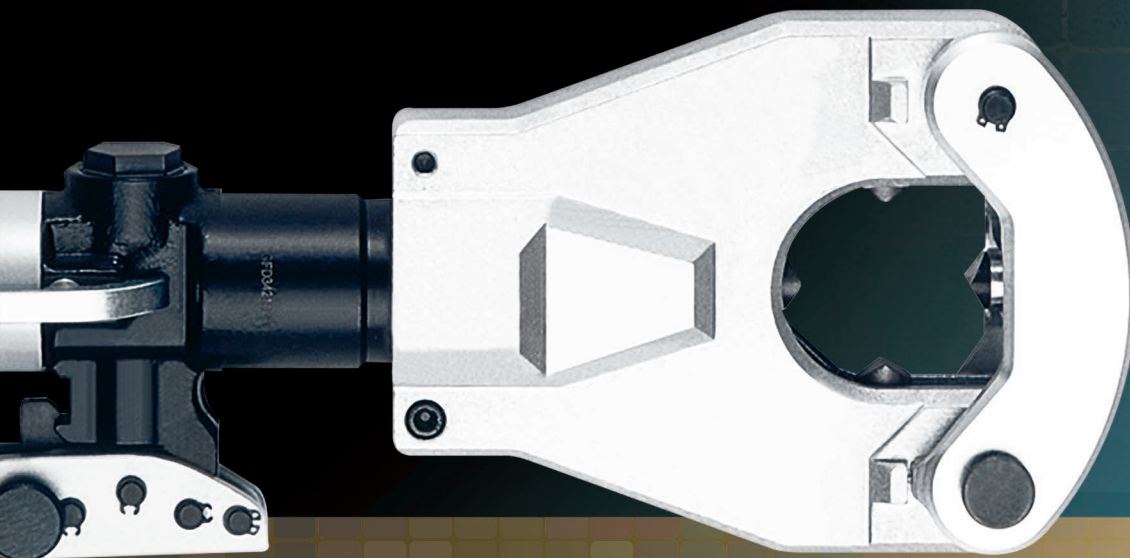

Accessories



Case

CT-920

The CT-920 is a hand-operated and light weight hydraulic crimping tool that is made of high quality aluminum. **This tool covers it all:** It crimps: lugs, splices and taps for use with copper: code, flex metric and aluminum conductor types.

Open C-Head design allows easy placement of connectors in tool

Crimp head rotates 350 degrees. Model is also available with 2-layer PVC insulation

Light weight aluminum design weighs 13 lbs.

Soft rubber inlay comfort grips

Automatic piston retraction to signal complete crimp

2 Stage rapid advance hydraulic system double action pump handle reduces number of pumps to make a crimp



Technical Data

CT-920

Crimping force 12 tons (108 kN)
Stroke/Opening width 1.65 inches (42mm)
Crimping range #8AWG -750 kcmil Cu. Code
#8 AWG - 535 kcmil Cu. Flex
#6 AWG - 600 kcmil Al.
10 mm² - 400 mm² Metric Class 2r metric
10 mm² - 300 mm² Class 5f & 6f metric

Length 22" (560mm)
Weight 13 lbs. (5.9 kg)
Ambient temperature -4°F - 104°F (-20°C to +40°C)

Ordering Information

CT-920 12 ton manual hydraulic global crimp tool.

CT/920CV US. 2 layer PVC covered crimp head.

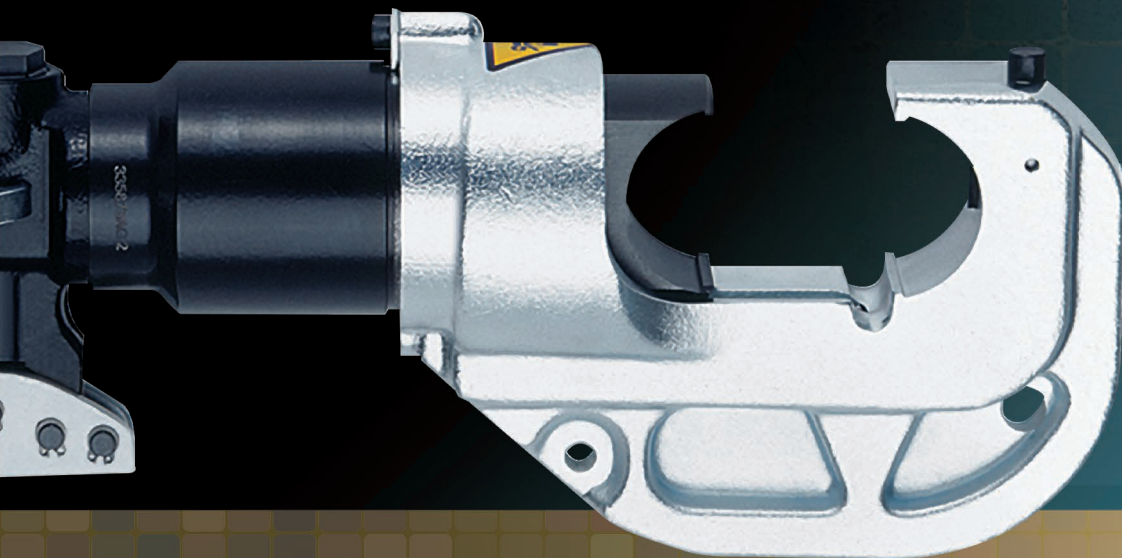

Accessories



Case

BlackFin™ Installation Tools Chart



Crimp Tool Series	CT-3001/ST	CT-3980	CT-3001/CCP	CT-2920/CCP	CT-2931/ST	CT-2940/ST
Crimp Force	6.7 ton (60 kN)	3.4-6.7 ton (30-60 kN)	6.7 ton (60 kN)	12 ton (120 kN)	12 ton (120 kN)	15 ton (135 kN)
Tool Configuration	In-Line	In-Line	In-Line	Pistol Grip	Pistol Grip	Pistol Grip
Crimp Range	<ul style="list-style-type: none"> • #8 AWG - 600 kcmil Cu. Code • #8 AWG - 373 kcmil Cu. Flex • #6 AWG - 350 kcmil Al. • 10mm² - 240 mm² Cu Class 2r metric • 10 mm² - 95 mm² Cu. Class 5f & 6f metric • #1/0 AWG - 500 kcmil ferrules 	<ul style="list-style-type: none"> • #8 AWG - 600 kcmil Cu. Code • #8 AWG - 373 kcmil Cu. Flex • #6 AWG - 350 kcmil Al. 	<ul style="list-style-type: none"> • #8 AWG - 600 kcmil Cu. Code • #8 AWG - 373 kcmil Cu. Flex • #6 AWG - 350 kcmil Al. • 10mm² - 240 mm² Cu Class 2r metric • 10 mm² - 95 mm² Cu. Class 5f & 6f metric, • #1/0 AWG - 500 kcmil ferrules • Crimps #1/0 AWG -500 kcmil ferrules • Cuts 1" dia. Cu & Al cable • Punches 2" dia. conduit holes in 10 ga. mild steel 	<ul style="list-style-type: none"> • #8 AWG -750 kcmil Cu. Code • #8 AWG - 535 kcmil Cu. Flex • #6 AWG - 600 kcmil Al. • 10mm² - 400 mm² Class 2 metric • 10 mm² - 300 mm² Class 5f & 6f metric • Crimps #1/0 AWG -500 kcmil ferrules • Cuts 1.5" dia. Cu. and Al. cable • Punches 5-5/8" dia. round holes in 10 ga. mild steel 	<ul style="list-style-type: none"> • #8 AWG -750 kcmil Cu. Code • #8 AWG - 535 kcmil Cu. Flex • #6 AWG - 600 kcmil Al. • 10 mm² - 400 mm² Class 2r metric • 10 mm² - 300 mm² Class 5f & 6f metric 	<ul style="list-style-type: none"> • #8 AWG - 1,000 kcmil Cu. Code • #8 AWG - 777.7 kcmil Cu. flex • 10 mm² -630 mm² Class 2r metric • 10mm² - 300 mm² metric Class 5f & 6f metric
Dieless		X				
Crimps, cuts cable and wire, punches sheet metal			X	X		

BlackFin™ Installation Tools Chart



Crimp Tool Series	CT-2980/ST	CT-2500/L	CT-2600/L	CT-2300/ST	CT-980	CT-920
Crimp Force	6.2 ton (55 kN)	1.7 ton (15kN)	4 ton (35 kN)	1.7 ton (15 kN)	6.2 ton (55 kN)	12 ton (120 kN)
Tool Configuration	Pistol Grip	In-Line	In-Line	Single Trigger	Manual Hydraulic	Manual Hydraulic
Crimp Range	<ul style="list-style-type: none"> • #4 AWG - 750 kcmil Cu. Code • #4 AWG - 500 kcmil Al. 	<ul style="list-style-type: none"> • Panduit #22 – 10 AWG insulated terminals, disconnects, and splices • Panduit #22 – 10 AWG fully insulated disconnects and insulated parallel splices • Panduit #22 – 10 AWG non-insulated terminals, disconnects, and splices • Panduit #26 - #8 AWG insulated and non-insulated ferrules and #22 - #12A AWG insulated twin ferrules • Panduit #8 - #6 AWG insulated and non-insulated ferrules and #10 AWG insulated twin ferrules 	<ul style="list-style-type: none"> • #8 AWG - #2 AWG large insulated and non-insulated terminals and butt splices • #8 AWG - 300 kcmil Cu. Code • #6 AWG - 2/0 AWG Al. 	<ul style="list-style-type: none"> • Panduit #22 – 10 AWG insulated terminals, disconnects, and splices • Panduit #22 – 10 AWG fully insulated disconnects and insulated parallel splices • Panduit #22 – 10 AWG non-insulated terminals, disconnects, and splices. • Panduit #26 - #8 AWG insulated and non-insulated ferrules and #22 - #12A AWG insulated twin ferrules. • Panduit #8 - #6 AWG insulated and non-insulated ferrules and #10 AWG insulated twin ferrules 	<ul style="list-style-type: none"> • #4 AWG - 750 kcmil Cu. Code • #4 AWG - 500 kcmil Al. 	<ul style="list-style-type: none"> • #8 AWG -750 kcmil Cu. Code • #8 AWG - 535 kcmil Cu. Flex • #6 AWG - 600 kcmil Al. • 10 mm² - 400 mm² Class 2r metric • 10 mm² - 300 mm² Class 5f & 6f metric
Dieless	X				X	
Crimps, cuts cable and wire, punches sheet metal						



Service Locations — For service contact information visit www.panduit.com/blackfin

cs@panduit.com

US and Canada: 800.777.3300

Europe, Middle East, and Africa:

44.20.8601.7200

Latin America: 52.33.3777.6000

Asia Pacific: 65.6305.7575

PANDUIT[®]

Panduit Corp.
World Headquarters
Tinley Park, IL 60487

www.panduit.com/blackfin