

Assembly Instructions for - 37352

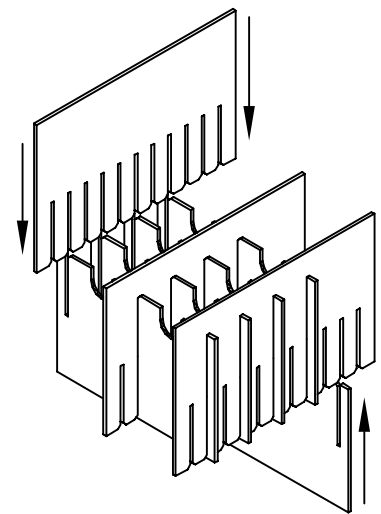
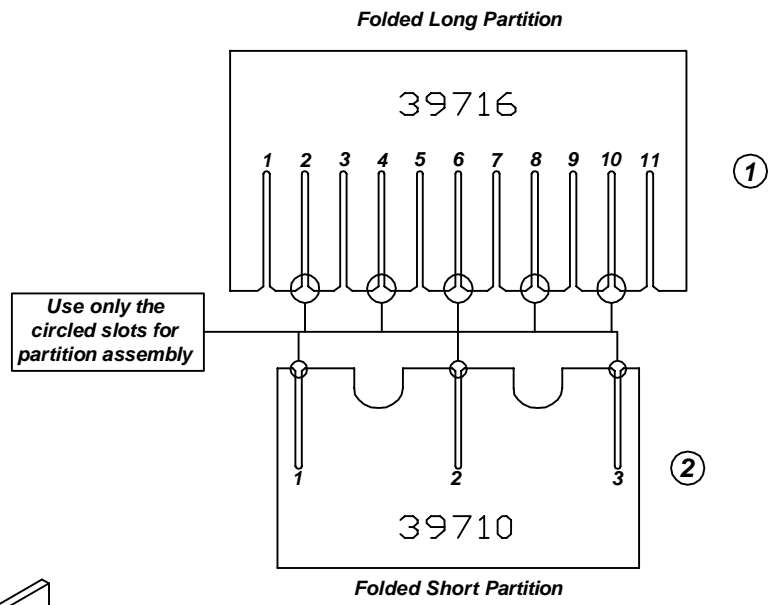
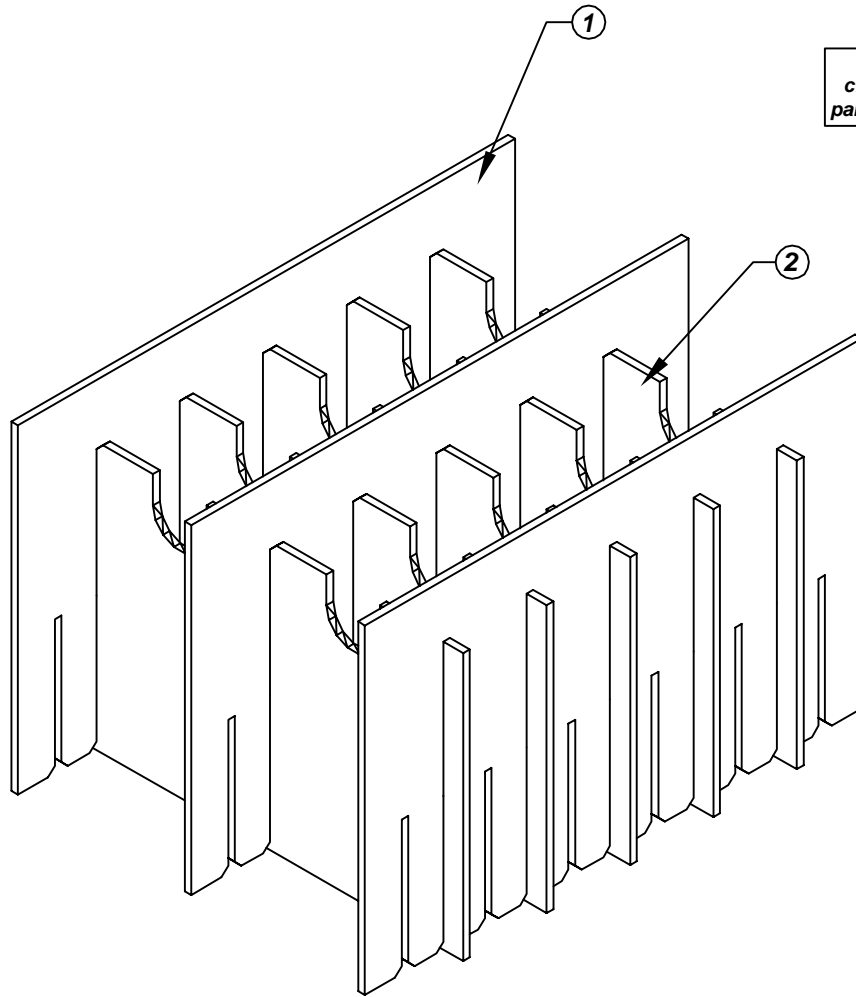

Made in America

F/N ①	Part # 39716	Dimensions: 24-1/4" x 18-5/8"	Description: 462-HLP-12 Long Partition	Qty: 3
F/N ②	Part # 39710	Dimensions: 20-1/4" x 14-3/4"	Description: 460/462/464-HSP Short Partition	Qty: 5

37352 - 12 Cell Inplant Handler Cell Size - 12" x 6-1/4" x 2-7/8"

Notes:
For use with the following storage container & lid:
37525 - Storage Container
37554 - Lid

PROTEKTIVE PAK
13520 MONTE VISTA AVENUE, CHINO, CA 91710
PHONE (909) 627-2578, FAX (909) 363-7331
ProtektivePak.com



DRAWING NUMBER
IPH-37352

DATE
Nov.
2007