

SPECIFICATIONS:

ELECTRICAL:
 INSULATOR RESISTANCE: 5,000 MegOHMS Min.
 DIELECTRIC WITHSTANDING: 1,000VAC r.m.s.
 OPERATING TEMPERATURE: -55° C ~ +125° C
 CONTACT RESISTANCE: 30 MillioHMS Max.
 POWER PINS: 40 AMPS
 SIGNAL PINS: 5 AMPS

MECHANICAL:
 CONTACT INSERTION FORCE: 4.5 Kg Max.
 CONTACT SEPARATOR FORCE: 0.3Kg Min.

MATERIALS:
 CONTACTS: BRASS
 INSULATOR: PBT UL94V-0 RATED,
 230°C PROCESS TEMP.
 SHELL: STEEL
 BOARD LOCK: BRASS, NICKEL PLATED
 CINCHNUT: BRASS, NICKEL PLATED
 BRACKET: STEEL, NICKEL PLATED

FINISH:
 SHELL: NICKEL

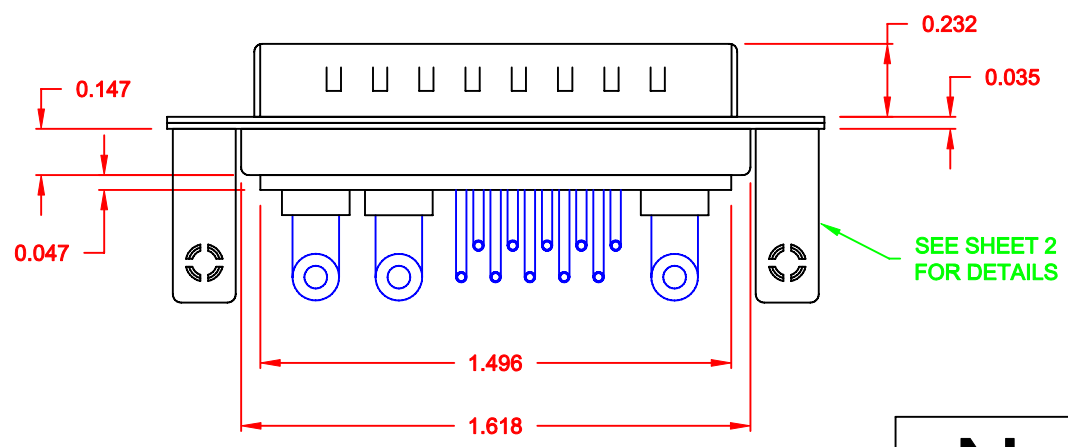
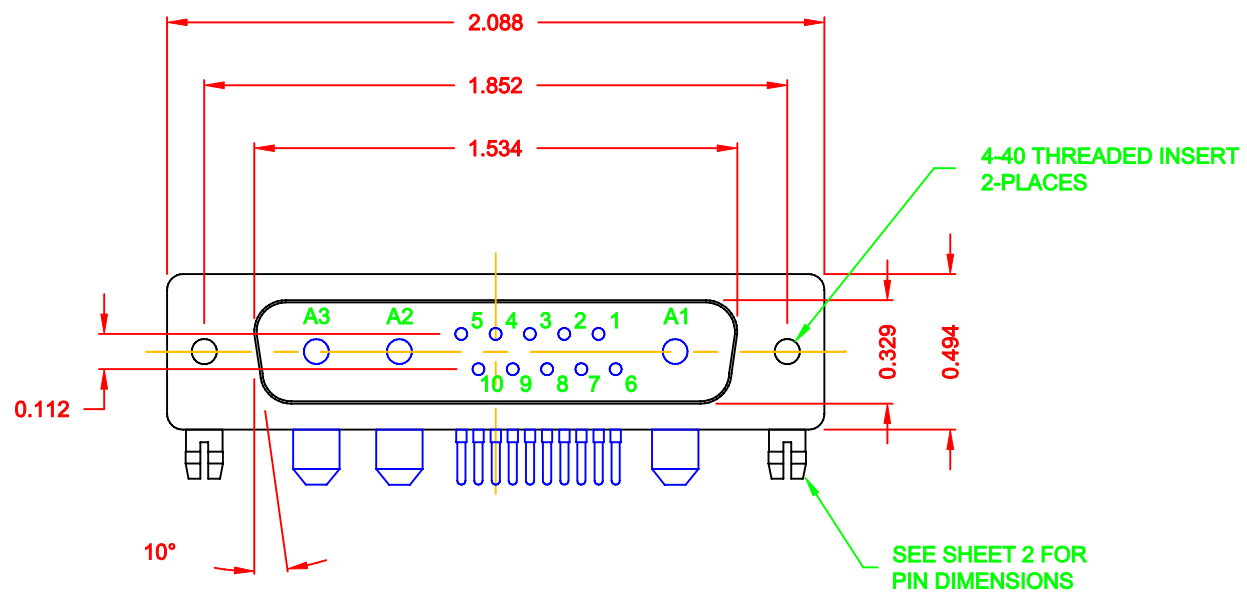

68413W3103L461

46 = 4-40 INSERTS / BOARD LOCKS

RoHS COMPLIANT

	THESE DRAWINGS AND SPECIFICATIONS ARE THE PROPERTY OF NorComp AND SHALL NOT BE REPRODUCED, COPIED OR USED AS THE BASIS FOR THE MANUFACTURE OR SALE OF APPARATUS WITHOUT WRITTEN PERMISSION.		DRAWN: C. SMITH	DATE: 10-06-06
			CHECKED:	DATE:
NorComp		SCALE: 1.5 = 1	SHEET 1 OF 2	REV 4
		DWG NO. 68413W3103L461		

NOTE:
POWER CONTACTS COME
PRE-LOADED INTO INSULATORS

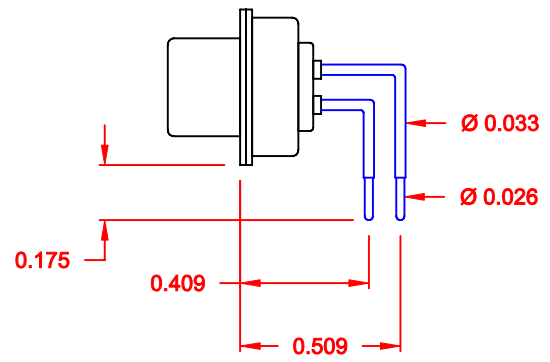
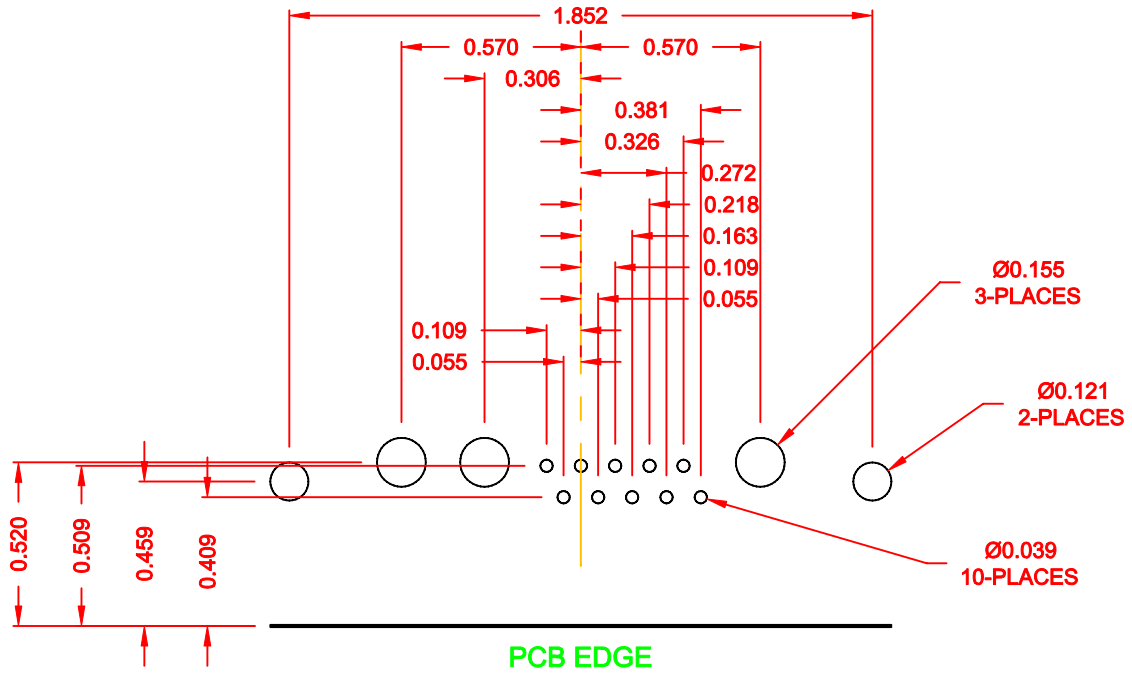

SIGNAL CONTACTS

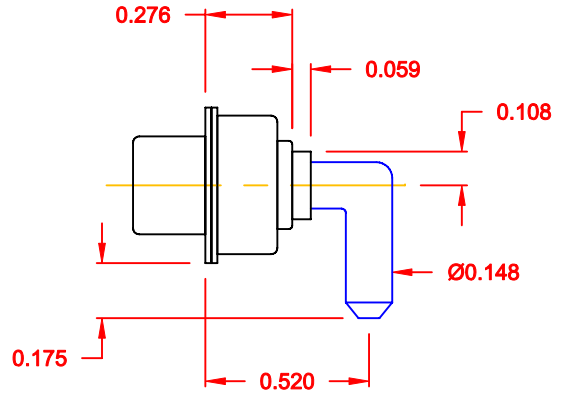

40 AMP POWER CONTACT

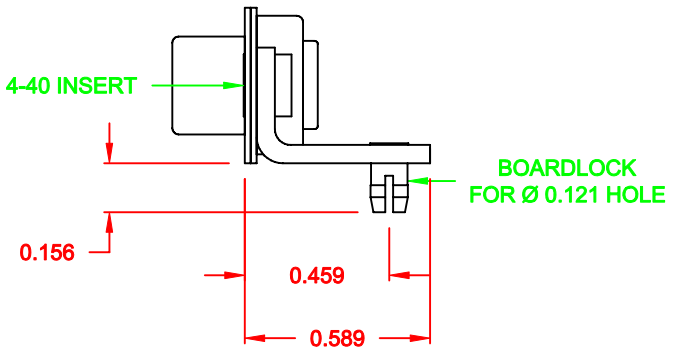

MOUNTING HARDWARE

RoHS COMPLIANT

	THESE DRAWINGS AND SPECIFICATIONS ARE THE PROPERTY OF NorComp AND SHALL NOT BE REPRODUCED, COPIED OR USED AS THE BASIS FOR THE MANUFACTURE OR SALE OF APPARATUS WITHOUT WRITTEN PERMISSION.		DRAWN: C. SMITH	DATE: 10-06-06
			CHECKED:	DATE:
NorComp	SCALE: 1.5 = 1	SHEET 2	OF 2	REV 4
	DWG NO. 68413W3103L461			