

Aug.1.2018 Copyright 2018 HIROSE ELECTRIC CO., LTD. All Rights Reserved.  
 In case that the application demands a high level of reliability, such as automotive,  
 please contact a company representative for further information.

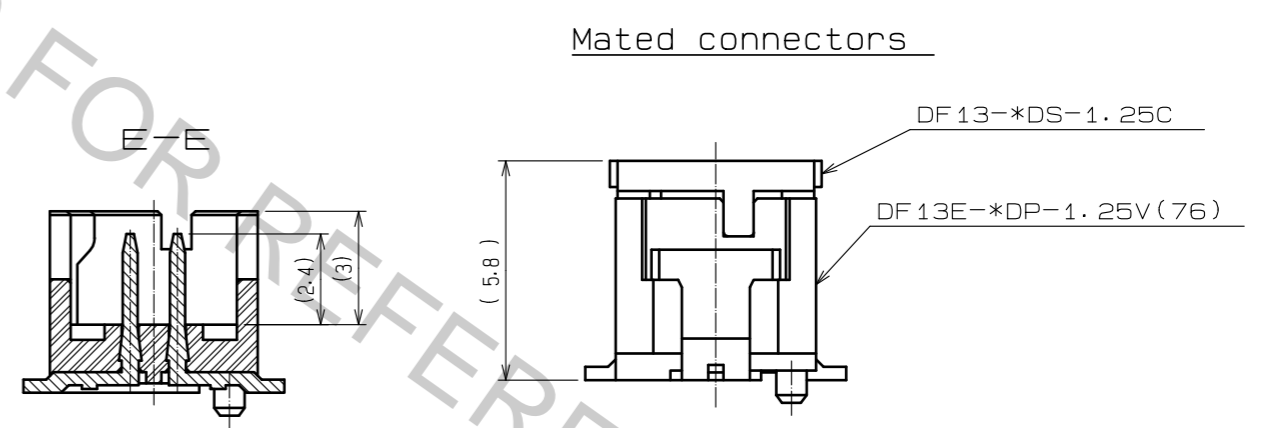
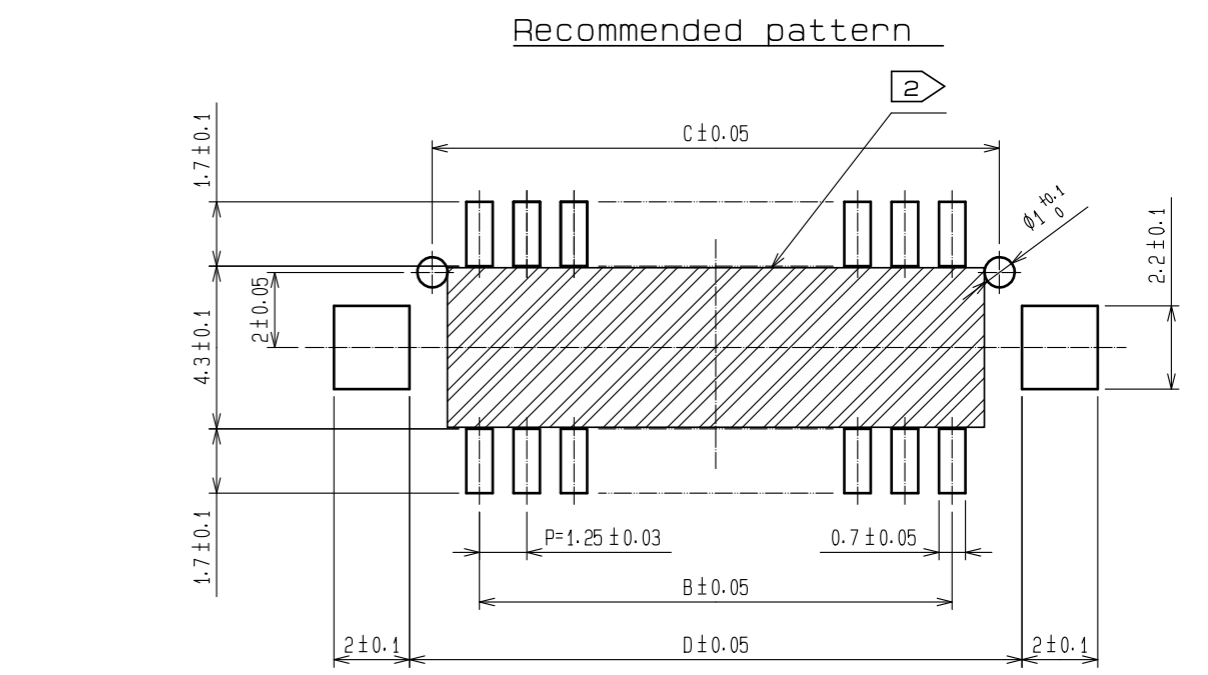
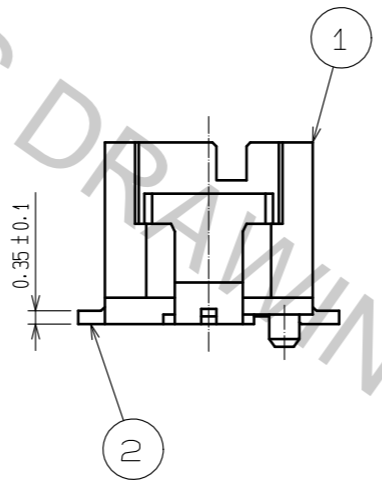
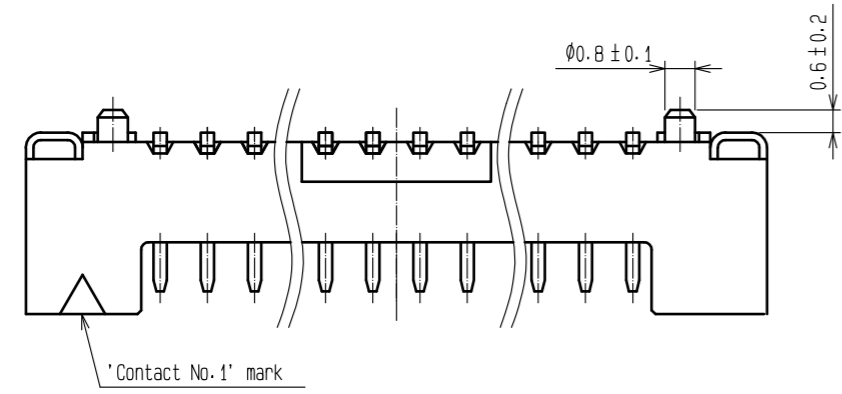
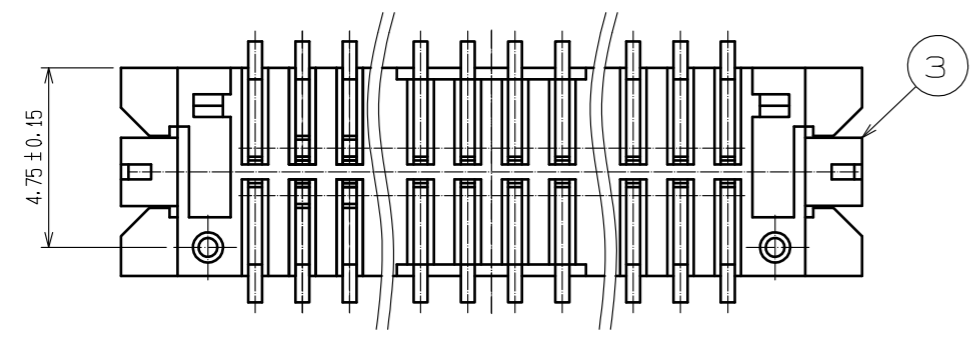
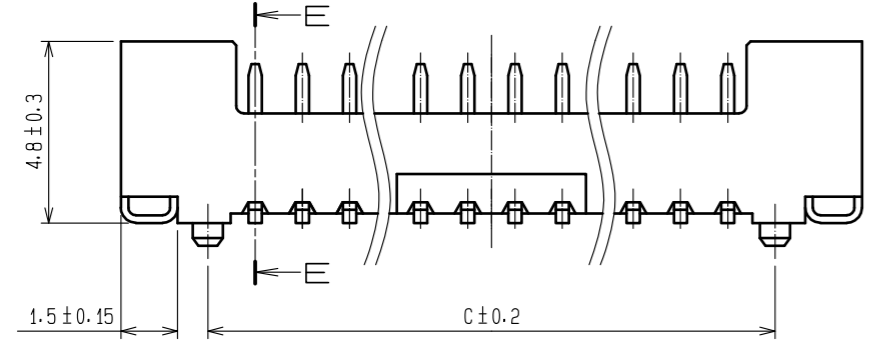
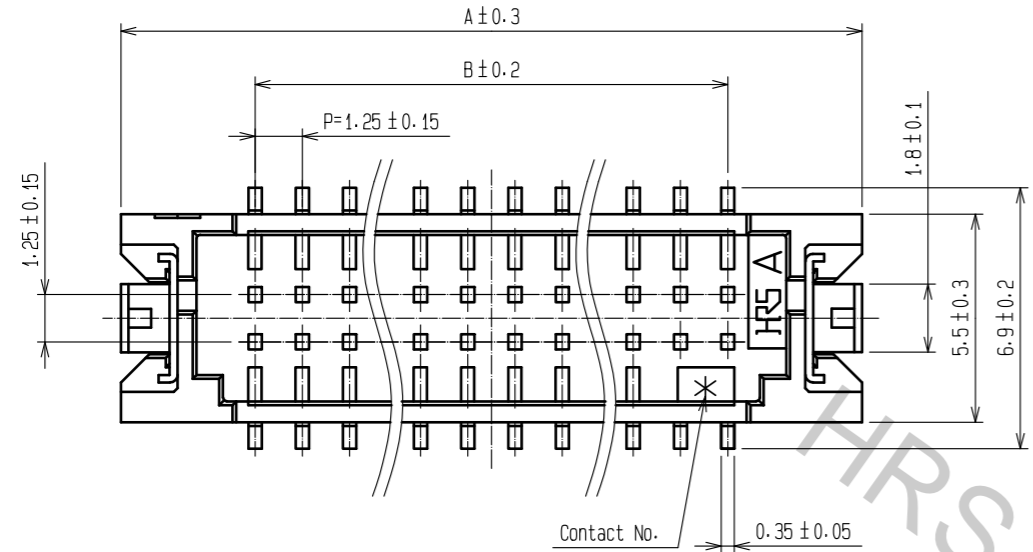

Notes 1 : Lead co-planality include reinforced metal fittings shall be 0.1mm MAX.  
 ②: If there are pattern and a bia hole on part, there is a possibility that it will make contact with the leads.

Part No.	Number of contacts	Code No.	A	B	C	D
DF13E-10DP-1.25V(76)	10	CL536-0566-0-76	12.1	5.0	7.5	8.7
DF13E-20DP-1.25V(76)	20	CL536-0567-0-76	18.35	11.25	13.75	14.95
DF13E-30DP-1.25V(76)	30	CL536-0568-0-76	24.60	17.50	20.00	21.20
DF13E-40DP-1.25V(76)	40	CL536-0569-0-76	30.85	23.75	26.25	27.45

NO.	MATERIAL	FINISH .	REMARKS	NO.	MATERIAL	FINISH .	REMARKS
2	Brass	Contact area:Gold plated 0.2µm MIN Lead area:Tin-copper plated 1µm MIN Under plating:Nickel 1µm MIN		5	Elastomer		Gray
1	Polyamide	Beige,UL94V-0		4	R.PVC		Electrostatic protection,Clear
				3	Phosphor bronze		Tin plated 1µm MIN

UNITS	SCALE	COUNT	DESCRIPTION OF REVISIONS	DESIGNED	CHECKED	DATE
mm	5 : 1	△				
HIROSE ELECTRIC CO., LTD.			APPROVED : HS. OKAWA 18.04.05 CHECKED : TS. FUKUSHIMA 18.04.05 DESIGNED : TS. KUMAZAWA 18.04.05 DRAWN : MK. INOUE 18.04.05	DRAWING NO. EDC-367983-76-00 PART NO. DF13E-*DP-1.25V(76) CODE NO. CL536-		

Aug.1.2018 Copyright 2018 HIROSE ELECTRIC CO., LTD. All Rights Reserved.  
 In case that the application demands a high level of reliability, such as automotive,  
 please contact a company representative for further information.

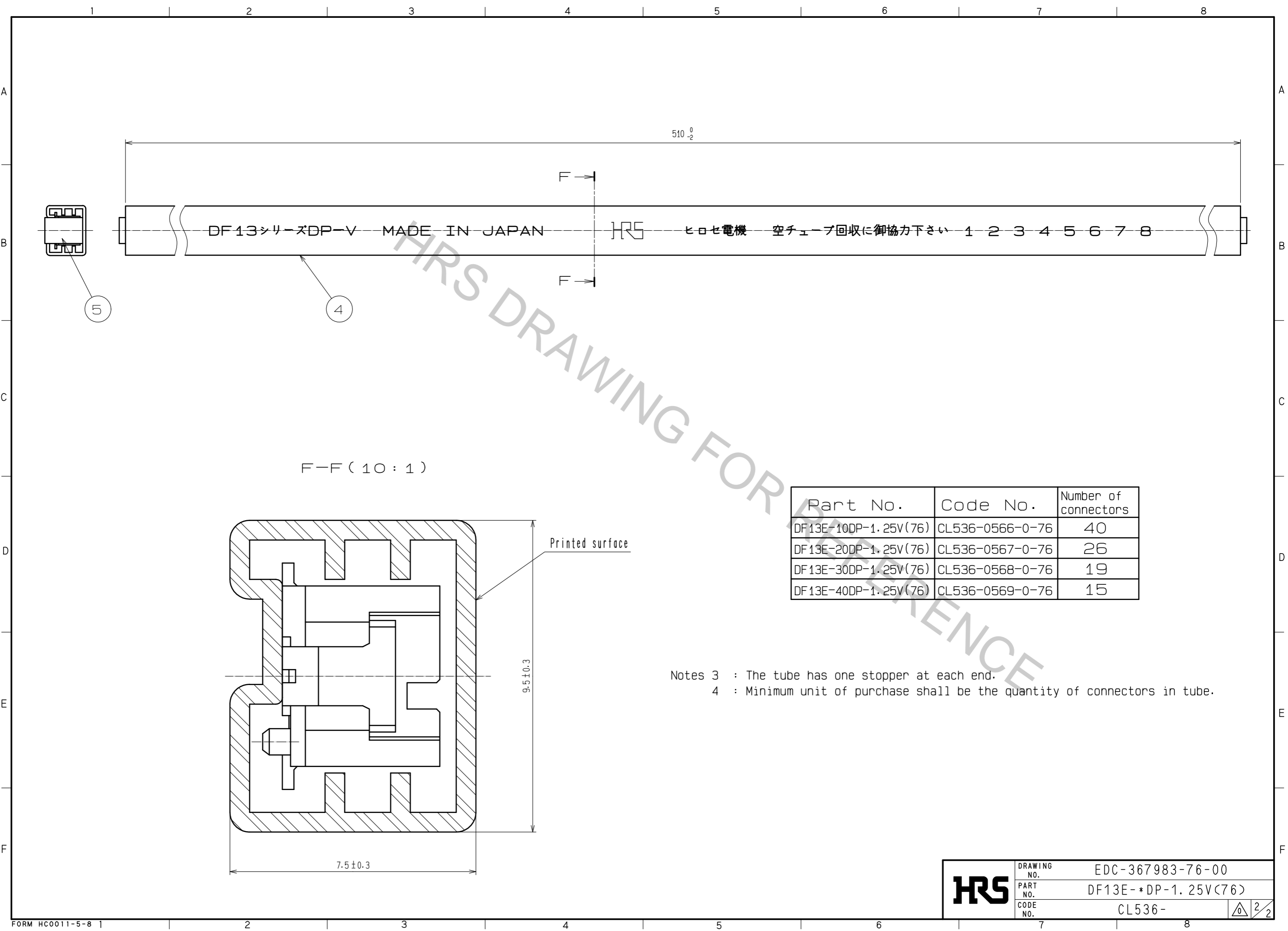

Part No.	Code No.	Number of connectors
DF13E-10DP-1.25V(76)	CL536-0566-0-76	40
DF13E-20DP-1.25V(76)	CL536-0567-0-76	26
DF13E-30DP-1.25V(76)	CL536-0568-0-76	19
DF13E-40DP-1.25V(76)	CL536-0569-0-76	15

Notes 3 : The tube has one stopper at each end.  
 4 : Minimum unit of purchase shall be the quantity of connectors in tube.

<b>HRS</b>	DRAWING NO.	EDC-367983-76-00	
	PART NO.	DF13E-*DP-1.25V(76)	
	CODE NO.	CL536-	2/2