



PLED150W Series– Fixed Output & Dimmable Flicker-Free LED Drivers Constant Current & Constant Voltage with Isolation Black Magic Thermal Advantage™ Aluminum Housing

Electrical Specifications

Input Voltage Range:	100-277 Vac Nom. (90-305 V Min/Max)
Input Over-Voltage:	Can endure 320Vac for 48 Hrs, 350Vac for 2 Hrs
Frequency:	50/60 Hz Nom. (47-63 Hz Min/Max)
Power Factor:	>0.90 @ > 70% load, 120-277V
Inrush Current:	<60.0 Amps max @ 277Vac, cold start, full load
Input Current:	0.75 Amps max @ 230Vac, 1.41 A max @ 120Vac
Maximum Power:	150W
Current Accuracy:	± 3%
Load Regulation:	± 4%
THD:	≤ 20% @ > 70% load, 120-277V
Ripple & Noise: (Vpk-pk)	5% Vo max @ 20 MHz BW, Full load output in parallel with 0.1 µF ceramic & 10 µF Electrolytic
Ripple: (Ipk-pk)	5% Io max @ 20 MHz BW, Full load output in parallel with 0.1 µF ceramic & 10 µF Electrolytic. 120 Hz component (Flicker Free)
Start-up Time:	150mS typical @ Full Load, 120Vac/60Hz (1000mS max)
Leakage Current:	0.68 mA max @ 120Vac, 0.75 mA max @ 277Vac
Hold Up Time:	30mS typical @ Full Load, 277Vac
Protection:	Over-Voltage, Over-Current, and Short Circuit (auto-recovery)

Environmental Specifications

Minimum Starting Temp:	-30°C
Maximum Case Temp.	90°C
UL Type TL Rating:	Non-Class 2: 90/82°C
Storage Temperature:	-40°C to +85°C
Humidity:	5% to 95%
Cooling:	Convection
Vibration Frequency:	5-55 Hz/2g, 30 minutes
MTBF:	260,000 Hours at full load and 40°C ambient conditions per MIL-217F Notice 2
EMC:	FCC 47CFR Part 15 Class B compliant
Impact Resistance:	1g/s
Weight:	24.4 oz (690 grams)

Ordering Options:

- D: 0-10V & Resistance dimmable models dim 100-10%. Two extra wires on the output side (+Purple/-Gray). Compatible with most quality 0-10V wall dimmers. See page 3.
- D3: 3-wire dimmable models dim 100-10%. Three extra wires on the output side (Yellow/Purple/Gray). Compatible with potentiometer dimming. See page 3.



- Total Power: 150 Watts
- Input Voltage: 100-277 Vac Nom.
- UL Dry & Damp Location Rated
- IP66 & NEMA6
- UL Type HL Rated for Hazardous Locations
- UL Sign Components Manual (S.A.M. Models)

Constant Current Versions - Product Specifications

Model Number	Output Current (mA ±5%)	Output Voltage Range (Vdc)	Max Output Power (W)	Typical Efficiency
PLED150W-428-C0350-XX	350	142-428	150	92%
PLED150W-333-C0450-XX	450	111-333	150	92%
PLED150W-283-C0530-XX	530	95-283	150	91%
PLED150W-214-C0700-XX	700	72-214	150	91%
PLED150W-142-C1050-XX	1050	48-142	150	91%
PLED150W-107-C1400-XX	1400	36-107	150	91%
PLED150W-085-C1750-XX	1750	29-85	150	90%
PLED150W-071-C2100-XX	2100	24-71	150	90%
PLED150W-061-C2450-XX	2450	21-61	150	90%
PLED150W-053-C2800-XX	2800	18-53	150	90%
PLED150W-048-C3150-XX	3150	16-48	150	89%
PLED150W-042-C3500-XX	3500	14-42	150	89%
PLED150W-035-C4200-XX	4200	12-35	150	89%
PLED150W-030-C4900-XX	4900	10-30	150	88%
PLED150W-024-C6250-XX	6250	8-24	150	88%

-XX indicates dimming options are available. See options at left. Blank = fixed current output

Constant Voltage Versions - Product Specifications

Model Number	Output Voltage (Vdc ±5%)	Output Current Range (mA)	Max Output Power (W)	Typical Efficiency
PLED150W-024 •	24	1563-6250	150	88%
PLED150W-030	30	1225-4900	150	88%
PLED150W-035	35	1050-4200	150	89%
PLED150W-042	42	875-3500	150	89%
PLED150W-048	48	788-3150	150	89%
PLED150W-053	53	700-2800	150	90%
PLED150W-061	61	613-2450	150	90%
PLED150W-071	71	525-2100	150	90%
PLED150W-085	85	438-1750	150	90%
PLED150W-107	107	350-1400	150	91%
PLED150W-142	142	263-1050	150	91%
PLED150W-214	214	175-700	150	91%
PLED150W-283	283	133-530	150	91%
PLED150W-333	333	113-450	150	92%
PLED150W-428	428	88-350	150	92%

• Indicates S.A.M.



Note:
LED drivers are designed and intended to operate LED loads only. Non-LED loading may be outside the specified design limits of our LED drivers, and therefore cannot be covered by any warranty. If you desire to use our LED drivers to operate non-LED loads please contact us to discuss compatibility.

Specifications subject to change without notice.

Rev 10-12-16



Dimensions - IN [mm]

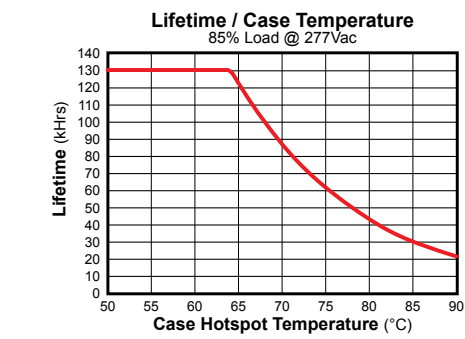
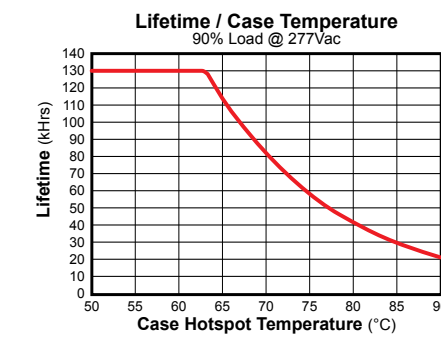
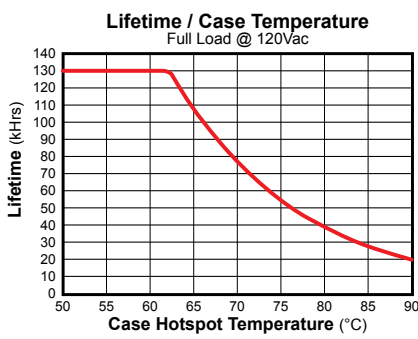
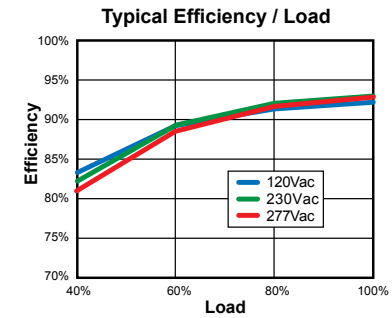
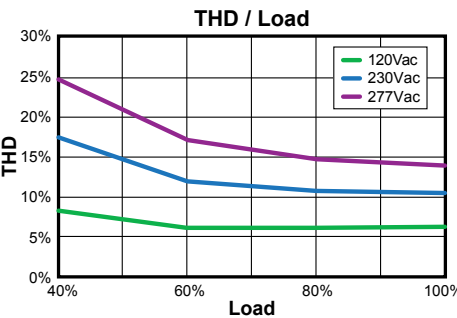
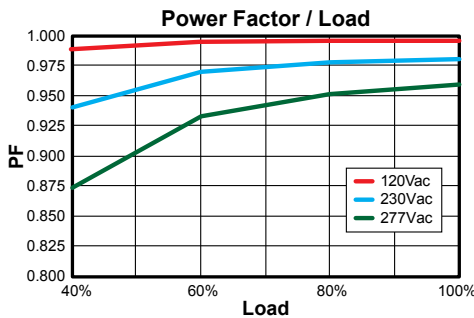
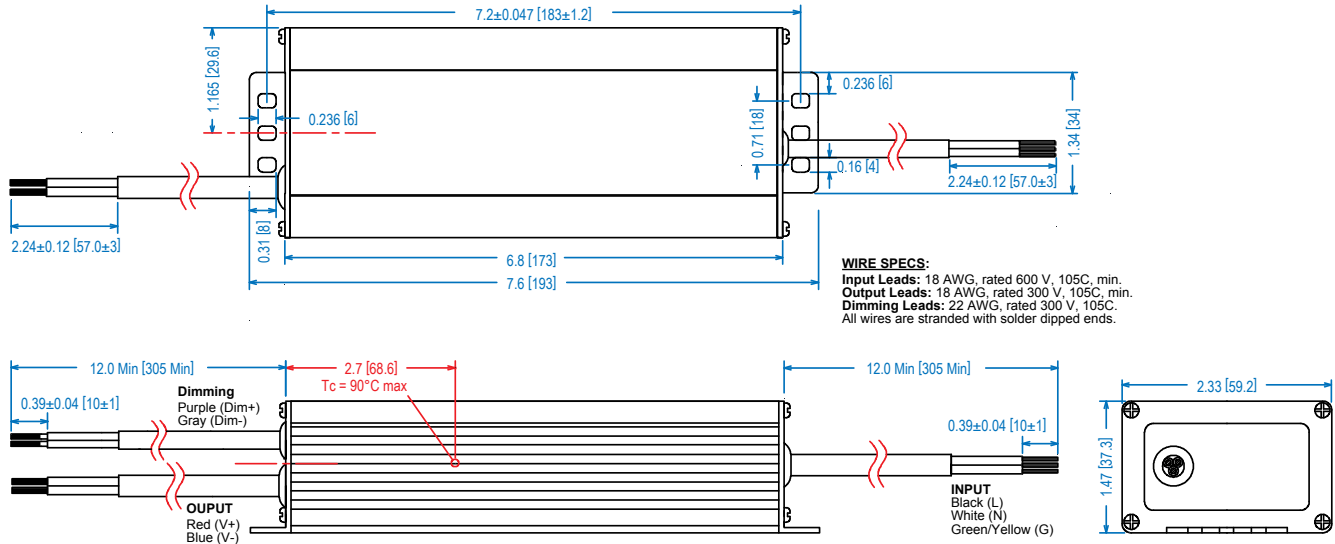

Note:
 The area under the life-temperature curve represents where the driver has highly reliable operation within specification. Driver performance may drift out of published specifications as the hours of operation exceed the curve at a given temperature. Higher operating temperatures increase the chances of a failure to function. Other electrical, mechanical and environmental factors affect driver lifetime but are not represented in this calculation.

Safety Cert.	Standard
UL/CUL	UL8750 & CAN/CSA-22.2 No. 250.13-12, UL1012/CSA-C22.2 No.107.1
CE	EN 61347-1, EN61347-2-13
EMC Standard	Notes
FCC, 47CFR Part 15	Class B
EN 55015	Limits and methods of measurement of radio disturbance characteristics of electrical lighting and similar equipment.
EN 61000-3-2	Part 3-2: Limits for harmonic current emissions Class C, >80% Rated Power
EN 61000-3-3	Part 3-3: Limitation of voltage changes, voltage fluctuations and flicker.
EN 61000-4-5	Part 4-5: Surge Immunity test, 2 kV L-N, 4 kV L-G & N-G

UL Conditions of Acceptability
 See website for additional information

"-D" and "-D3" Options: 0-10VDC and Resistance Dimming

Parameters	Minimum	Typical	Maximum
10V Output, Yellow Wire	9.2V	10.0V	10.8V
Source Current out of Aux Yellow Wire	—	—	10mA
Absolute Voltage Range on 0-10V (+) Purple Wire	-2.0V	—	+15V
Source Current out of 0-10V Purple Wire	0mA	—	2mA

Typical Dimming Circuit

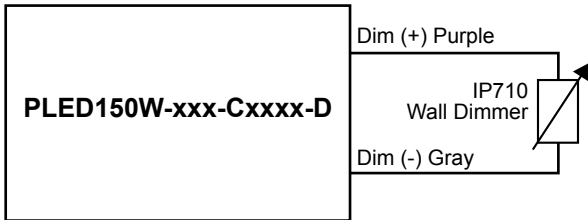

(Dimmer must be current-sink type control)

3-Wire Dimming Typical Circuit

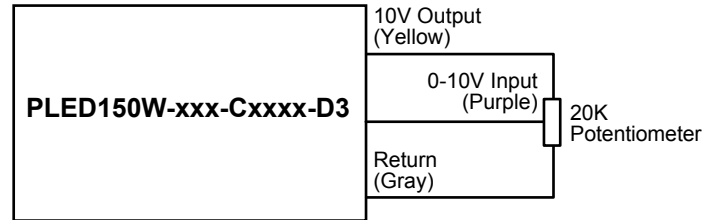

Output Current / 0-10VDC Dimming Input

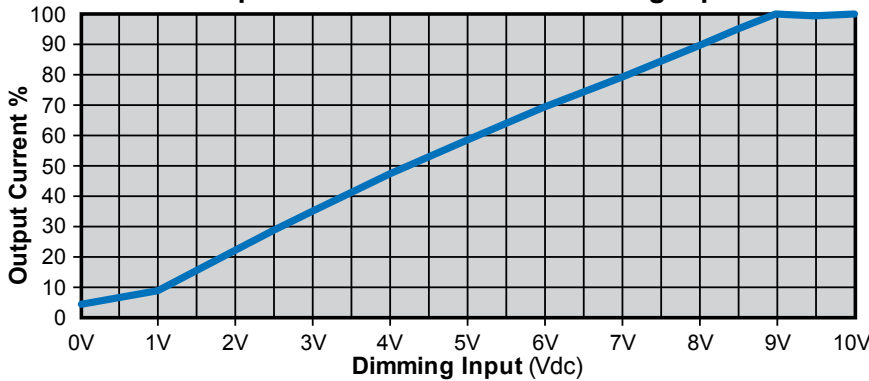

Notes:

1. 0-10V dimmable version comes with an extra two wires +Purple/-Gray on the output side.
2. Compatible with most 0-10V Wall Slide dimmers and direct 0-10V analog signal. Recommended dimmer is Leviton IP710 or equivalent
3. 0-10V dimmable version is not intended to dim to zero (off). Will be lout <10% @ Vdim <1.0V
4. 0-10V dimmable version output will be 100% with Purple/Gray open and minimum with Purple/Gray Shorted.