

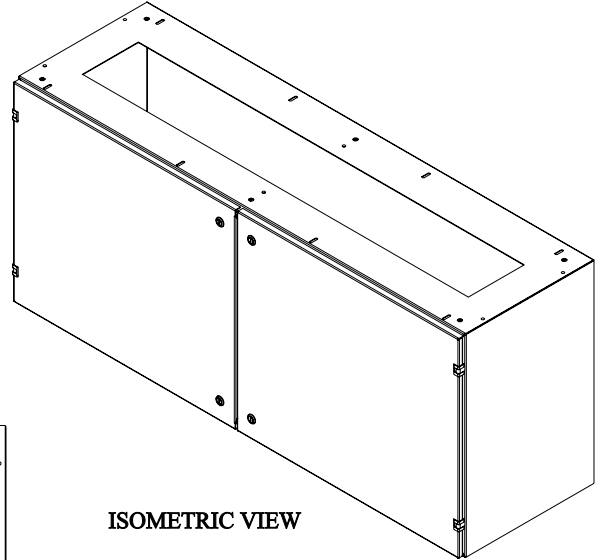

**PART No. 2CSB266018**  
for more information visit  
[www.hammfg.com](http://www.hammfg.com)  
Data subject to change without notice  
Isometric drawing Not to Scale

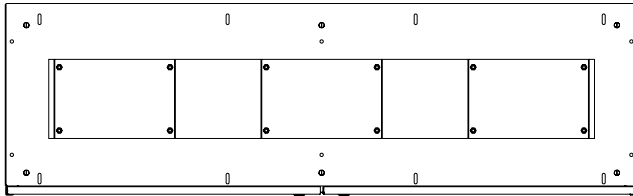

**ISOMETRIC VIEW**



**TOP VIEW**

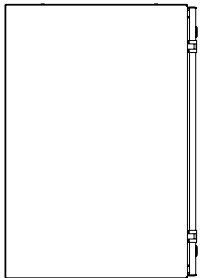

**LEFT SIDE VIEW**

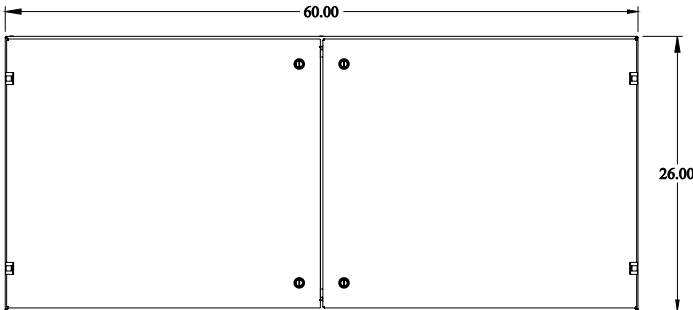

**FRONT VIEW**

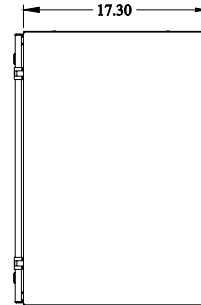

**RIGHT SIDE VIEW**

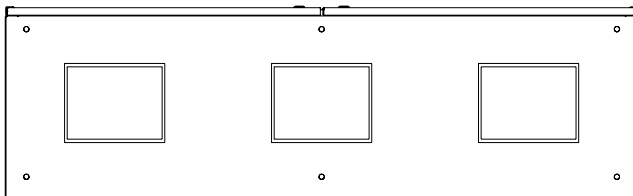

**BOTTOM VIEW**