

Dimensions: [mm]

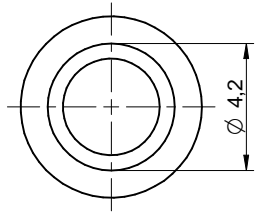

sectional drawing A-A

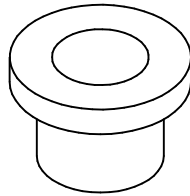
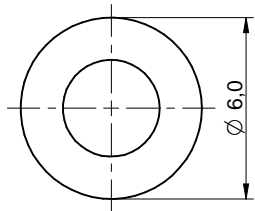
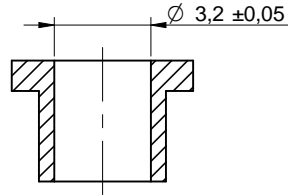
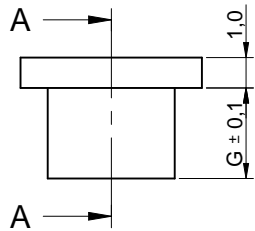

Scale - 4:1

Recommended Land Pattern: [mm]

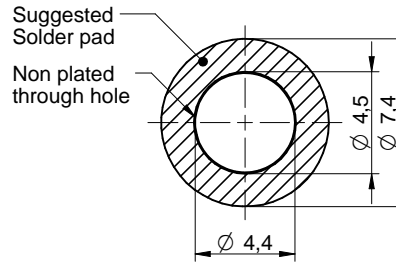

Scale - 3:1

Stencil Suggestion:

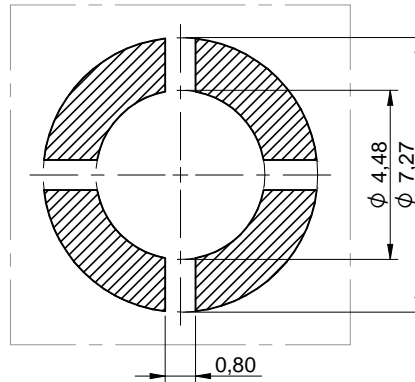

Scale - 5:1

Properties:

Properties		Value	Unit
Inner Diameter	Ø ID	4.2	mm
Outer Diameter	Ø OD	6	mm
Hole Diameter	Ø f	3.2	mm
Material		Steel	
Surface		Tin	
Solder Cream Thickness		150 µm	

Packaging Properties:

Packaging	Bulk
-----------	------

Article Properties:

Properties		Value	Unit
Pin length	G	4.6	mm

Würth Elektronik eiSos GmbH & Co. KG
EMC & Inductive Solutions

Max-Eyth-Str. 1
74638 Waldenburg
Germany
Tel. +49 (0) 79 42 945 - 0



www.we-online.com
eiSos@we-online.com



CREATED DaMa	CHECKED SKI	GENERAL TOLERANCE DIN ISO 2768-1m	PROJECTION METHOD
DESCRIPTION WA-SMSR SMD Steel Spacer Reverse with through hole Ø3.2		ORDER CODE 977 504 696 0	
REVISION 001.000	STATUS Valid	DATE 2016-09-22	BUSINESS UNIT eiCan
		PAGE 1/5	

Article Properties:

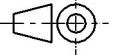
G	Order Code
2.6 mm	977 502 696 0
	977 502 696 OR
3.1 mm	977 503 196 0
	977 503 196 OR
3.6 mm	977 503 696 0
	977 503 696 OR
4.1 mm	977 504 196 0
	977 504 196 OR
4.6 mm	977 504 696 0
	977 504 696 OR
5.1 mm	977 505 196 0
	977 505 196 OR
5.6 mm	977 505 696 0
	977 505 696 OR
6.6 mm	977 506 696 0
	977 506 696 OR
7.6 mm	977 507 696 0
	977 507 696 OR
8.6 mm	977 508 696 0
	977 508 696 OR
9.6 mm	977 509 696 0
	977 509 696 OR
10.6 mm	977 510 696 0
	977 510 696 OR
11.6 mm	977 511 696 0
	977 511 696 OR

Würth Elektronik eiSos GmbH & Co. KG EMC & Inductive Solutions Max-Eyth-Str. 1 74638 Waldenburg Germany Tel. +49 (0) 79 42 945 - 0 www.we-online.com eiSos@we-online.com		CREATED DaMa	CHECKED SKI	GENERAL TOLERANCE DIN ISO 2768-1m	PROJECTION METHOD 
DESCRIPTION WA-SMSR SMD Steel Spacer Reverse with through hole Ø3.2			ORDER CODE 977 504 696 0		
		REVISION 001.000	STATUS Valid	DATE 2016-09-22	BUSINESS UNIT eiCan
				PAGE 2/5	

Classification Reflow Profile for SMT components:



Classification Reflow Soldering Profile:

Profile Feature		Value
Preheat Temperature Min ¹⁾	$T_{s \text{ min}}$	150 °C
Preheat Temperature Max	$T_{s \text{ max}}$	200 °C
Preheat Time t_s from $T_{s \text{ min}}$ to $T_{s \text{ max}}$	t_s	60 - 120 seconds
Ramp-up Rate (T_L to T_p)		3 °C/ second max.
Liquidous Temperature	T_L	217 °C
Time t_L maintained above T_L	t_L	60 - 150 seconds
Peak package body temperature	T_p	see table
Time within 5°C of actual peak tempereure	t_p	20 - 30 seconds
Ramp-down Rate (T_L to T_p)		6 °C/ second max.
Time 25°C to peak temperature		8 minutes max.

¹⁾ refer to IPC/JEDEC J-STD-020D
refer to IPC/ JEDEC J-STD-020E

Package Classification Reflow Temperature:

Properties	Volume mm ³ <350	Volume mm ³ 350-2000	Volume mm ³ >2000
PB-Free Assembly Package Thickness < 1.6 mm ¹⁾	260 °C	260 °C	260 °C
PB-Free Assembly Package Thickness 1.6 mm - 2.5 mm	260 °C	250 °C	245 °C
PB-Free Assembly Package Thickness ≥ 2.5 mm	250 °C	245 °C	245 °C

¹⁾ refer to IPC/JEDEC J-STD-020D
refer to IPC/ JEDEC J-STD-020E

Würth Elektronik eiSos GmbH & Co. KG
EMC & Inductive Solutions

Max-Eyth-Str. 1
74638 Waldenburg
Germany
Tel. +49 (0) 79 42 945 - 0

www.we-online.com
eiSos@we-online.com



CREATED DaMa	CHECKED SKI	GENERAL TOLERANCE DIN ISO 2768-1m	PROJECTION METHOD
DESCRIPTION WA-SMSR SMD Steel Spacer Reverse with through hole Ø3.2		ORDER CODE 977 504 696 0	
REVISION 001.000	STATUS Valid	DATE 2016-09-22	BUSINESS UNIT eiCan
		PAGE 3/5	

Cautions and Warnings:

The following conditions apply to all goods within the product series of WA-SMSR of Würth Elektronik eiSos GmbH & Co. KG:

General:

All recommendations according to the general technical specifications of the data-sheet have to be complied with.

The responsibility for the applicability of customer specific products and use in a particular customer design is always within the authority of the customer. All technical specifications for standard products do also apply for customer specific products.

Product Specific:

Follow all instructions in the datasheet, especially:

- The solder profile has to be complied with according to the technical reflow soldering specification, otherwise no warranty will be sustained. Surface discoloration due to reflow processing is permitted.
- Wave soldering is not applicable. Reflow soldering is recommended.
- All products shall be used before the end of the period of 12 months based on the product date-code, if not a 100% solderability can't be ensured.
- The maximum permissible torques must be complied with to prevent mechanical destruction of the elements and PCB.

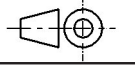
Würth Elektronik eiSos GmbH & Co. KG EMC & Inductive Solutions Max-Eyth-Str. 1 74638 Waldenburg Germany Tel. +49 (0) 79 42 945 - 0 www.we-online.com eiSos@we-online.com 	CREATED DaMa	CHECKED SKI	GENERAL TOLERANCE DIN ISO 2768-1m	PROJECTION METHOD 	
	DESCRIPTION WA-SMSR SMD Steel Spacer Reverse with through hole Ø3.2			ORDER CODE 977 504 696 0	
	REVISION 001.000	STATUS Valid	DATE 2016-09-22	BUSINESS UNIT eiCan	PAGE 4/5

Important Notes

The following conditions apply to all goods within the product range of Würth Elektronik eiSos GmbH & Co. KG:

1. General Customer Responsibility

Some goods within the product range of Würth Elektronik eiSos GmbH & Co. KG contain statements regarding general suitability for certain application areas. These statements about suitability are based on our knowledge and experience of typical requirements concerning the areas, serve as general guidance and cannot be estimated as binding statements about the suitability for a customer application. The responsibility for the applicability and use in a particular customer design is always solely within the authority of the customer. Due to this fact it is up to the customer to evaluate, where appropriate to investigate and decide whether the device with the specific product characteristics described in the product specification is valid and suitable for the respective customer application or not.

2. Customer Responsibility related to Specific, in particular Safety-Relevant Applications

It has to be clearly pointed out that the possibility of a malfunction of electronic components or failure before the end of the usual lifetime cannot be completely eliminated in the current state of the art, even if the products are operated within the range of the specifications. In certain customer applications requiring a very high level of safety and especially in customer applications in which the malfunction or failure of an electronic component could endanger human life or health it must be ensured by most advanced technological aid of suitable design of the customer application that no injury or damage is caused to third parties in the event of malfunction or failure of an electronic component. Therefore, customer is cautioned to verify that data sheets are current before placing orders. The current data sheets can be downloaded at www.we-online.com.

3. Best Care and Attention

Any product-specific notes, cautions and warnings must be strictly observed. Any disregard will result in the loss of warranty.

4. Customer Support for Product Specifications

Some products within the product range may contain substances which are subject to restrictions in certain jurisdictions in order to serve specific technical requirements. Necessary information is available on request. In this case the field sales engineer or the internal sales person in charge should be contacted who will be happy to support in this matter.

5. Product R&D

Due to constant product improvement product specifications may change from time to time. As a standard reporting procedure of the Product Change Notification (PCN) according to the JEDEC-Standard inform about minor and major changes. In case of further queries regarding the PCN, the field sales engineer or the internal sales person in charge should be contacted. The basic responsibility of the customer as per Section 1 and 2 remains unaffected.

6. Product Life Cycle

Due to technical progress and economical evaluation we also reserve the right to discontinue production and delivery of products. As a standard reporting procedure of the Product Termination Notification (PTN) according to the JEDEC-Standard we will inform at an early stage about inevitable product discontinuance. According to this we cannot guarantee that all products within our product range will always be available. Therefore it needs to be verified with the field sales engineer or the internal sales person in charge about the current product availability expectancy before or when the product for application design-in disposal is considered. The approach named above does not apply in the case of individual agreements deviating from the foregoing for customer-specific products.

7. Property Rights

All the rights for contractual products produced by Würth Elektronik eiSos GmbH & Co. KG on the basis of ideas, development contracts as well as models or templates that are subject to copyright, patent or commercial protection supplied to the customer will remain with Würth Elektronik eiSos GmbH & Co. KG. Würth Elektronik eiSos GmbH & Co. KG does not warrant or represent that any license, either expressed or implied, is granted under any patent right, copyright, mask work right, or other intellectual property right relating to any combination, application, or process in which Würth Elektronik eiSos GmbH & Co. KG components or services are used.

8. General Terms and Conditions

Unless otherwise agreed in individual contracts, all orders are subject to the current version of the "General Terms and Conditions of Würth Elektronik eiSos Group", last version available at www.we-online.com.

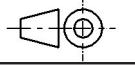
Würth Elektronik eiSos GmbH & Co. KG EMC & Inductive Solutions Max-Eyth-Str. 1 74638 Waldenburg Germany Tel. +49 (0) 79 42 945 - 0 www.we-online.com eiSos@we-online.com 	CREATED DaMa	CHECKED SKI	GENERAL TOLERANCE DIN ISO 2768-1m	PROJECTION METHOD 	
	DESCRIPTION WA-SMSR SMD Steel Spacer Reverse with through hole Ø3.2			ORDER CODE 977 504 696 0	
	REVISION 001.000	STATUS Valid	DATE 2016-09-22	BUSINESS UNIT eiCan	PAGE 5/5