

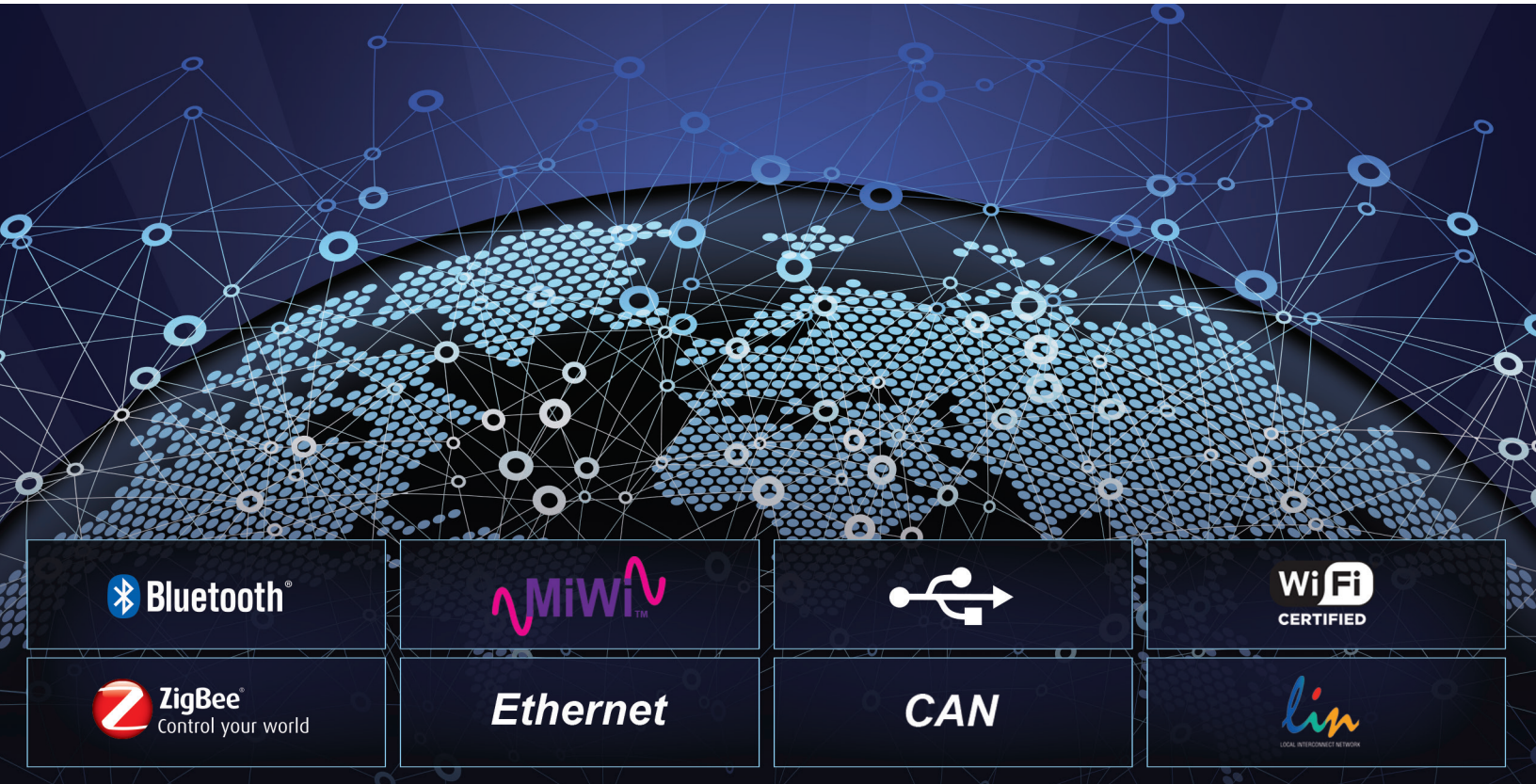

Connectivity Solutions for Embedded Design

USB, Ethernet, Wi-Fi®, Bluetooth®, ZigBee®, MiWi™ Wireless Networking Protocol, IoT, CAN, LIN, IrDA® and RS-485 Protocols



 Bluetooth®

 MiWi™



 Wi-Fi
CERTIFIED

 ZigBee®
Control your world

Ethernet

CAN

 lin
LOCAL INTERCONNECT NETWORK

Embedded Wireless Solutions

Targeting the Need for Low-Power Wireless Connectivity

Wireless communication technologies have been commonplace in homes and industry for many years. Recent trends in cloud computing, Internet of Things (IoT) and Smart Grid initiative have created a renewed demand for standardized, low-power wireless technology in metering, home, business and industrial automation markets. As a result, Microchip offers many IEEE 802.11™, IEEE 802.15.4™ and ZigBee® standard solutions along with our proprietary MiWi™ wireless networking protocol for both 2.4 GHz and Sub-GHz to address this need.

Wi-Fi® IEEE 802.11

Microchip has a broad portfolio of Wi-Fi products including complete agency-certified 802.11 b/g modules, 802.11 b/g Wi-Fi transceivers and RF chipset solutions that make adding Wi-Fi simple. Our modules include full TCP/IP stacks and networking services in compact surface mount components, saving you development time and testing cost.

- Low power for battery-powered applications
- Regulatory agency-certified
- WEP, WPA1, WPA2, WPA-EAP Security
- Supports SoftAP, Ad hoc and Infrastructure networking modes
- Supports WPS, FTP, HTTP, DHCP, Wi-Fi Direct and more
- Over-the-air firmware upgrade

RN Wi-Fi Series

RN171, RN131 Modules



- Full on-board TCP/IP stack and services (no external drivers required or royalties)
- Simple ASCII command interface
- Works with any microcontroller

RN171 Wi-Fi Evaluation Kit (RN-171-EK)



The RN-171-EK is an 802.11 b/g Wi-Fi evaluation kit for the RN171 module. It can be used to quickly add Wi-Fi connectivity to embedded applications. It has the flexibility to connect directly

to a PC via a standard USB interface or to embedded processors through the TTL/UART interface. The board includes two convenient pushbuttons for controlling both SoftAP and WPS modes without software configuration. The status LEDs and jumpers enable rapid prototyping and integration into existing systems.

RN171 Wi-Fi PICtail™/PICtail Plus Daughter Board (RN-171-PICtail)



The RN-171-PICtail allows you to easily develop Wi-Fi applications using Microchip's 8-, 16- and 32-bit PIC® microcontrollers. It includes a fully integrated TCP/IP stack allowing for a simple serial-to-Wi-Fi connection to the microcontroller.

MRF Wi-Fi Series

MRF24WB0MA/MB, MRF24WG0MA/MB



- Royalty-free TCP/IP stack and services on PIC microcontroller
- Full service implementations for web server, email, FTP
- IPv4 and IPv6 support

Wi-Fi G Demo Board (DV102412)



The Wi-Fi G Demo Board is a compact demonstration platform which allows you to easily evaluate and configure the fully certified MRF24WG0MA 802.11 b/g Wi-Fi module. The demo board is a fully functional standalone web server powered by two AAA batteries. It comes with the MRF24WG0MA Wi-Fi module connected to a PIC32 with TCP/IP stack pre-configured to serve web pages and show SoftAP, Wi-Fi Direct client and WPS functions.

MRF24WG0MA Wi-Fi G PICtail/PICtail Plus Daughter Board (AC164149)



The MRF24WG0MA Wi-Fi PICtail/PICtail Plus Daughter Board is a demonstration board for evaluating Wi-Fi connectivity using PIC microcontrollers and the MRF24WG0MA module. This product is compatible with the Explorer 16 Development Board (DM240001), PICDEM.net™ 2 Development Board (DM163024) and PIC32 Starter Kit (DM320001) with I/O Expansion Board (DM320002).

More information is available at: www.microchip.com/wifi.

WCM Development Kit 1 (DM182020)

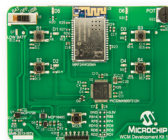

The Wi-Fi Client Module (WCM) Development Kit 1 is designed to enable you to quickly and easily connect an embedded system to a cloud-based server, such as Amazon Web Services (AWS). This will reduce the learning curve and help you get connected to the cloud quickly. This entire ecosystem can be set up in a matter of a few minutes by launching Microchip's Amazon Machine Image (AMI) via the AWS Marketplace, commissioning the development kit to connect to your local Wi-Fi router and run the demo.

More information is available at: www.microchip.com/iot.

Embedded Wireless Solutions

Targeting the Need for Low-Power Wireless Connectivity

Certified Bluetooth® Modules

Bluetooth is finding a home in multiple new markets thanks to the Smartphone and other mobile devices. Microchip recognizes the value of Bluetooth connectivity and is leading the way with low-power Bluetooth solutions designed for drop-in connectivity.

- Bluetooth 4.1 Low Energy (BTLE) module with complete on-board stack
- Bluetooth Classic 2.1 + EDR and 3.0 (audio only) compact surface mount modules
- Class 1 and Class 2 modules with an onboard stack, multiple embedded Bluetooth profiles and a simple ASCII command interface
- Work seamlessly with Android™ and iPhone® devices

RN4020 Bluetooth Low Energy Module



- Fully certified Bluetooth version 4.1 module
- On-board embedded Bluetooth low energy stack
- Simple ASCII command interface over UART
- Data streaming with Microchip's Low Energy Data Profile (MLDP)
- Scripting for stand-alone module operation with analog and digital data collection

RN4020 PICTail/PICTail Plus Daughter Board (RN-4020-PICTAIL)

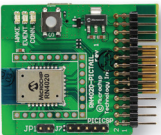

- For flexible development with the RN4020 BTLE module
- Connection and data status LEDs
- USB to UART interface to quickly get started
- PICTail and PICTail Plus interfaces for connection to Microchip development boards
- eXtreme Low Power PIC18F25K50 MCU on board
- PICkit™ serial programmer/debugger interface

RN41/RN42 Modules



- Low-power embedded modules
- On-board embedded Bluetooth stack (no host processor required)
- Supports SPP, HID, HCI, iAP
- UART data connection hardware interface
- Auto-discovery/auto-connect requires no software configuration (instant cable replacement)

RN42 Bluetooth Evaluation Kit (RN-42-EK)

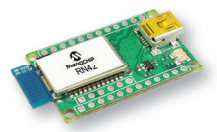

The RN-42-EK is a fully certified Class 2 Bluetooth evaluation kit for the RN42 module. It has the flexibility to connect directly to a PC via a standard USB interface or to embedded processors through the TTL UART interface. The status LEDs, switches and signal headers enable rapid prototyping and integration into existing systems.

RN52 Module



- Fully certified Bluetooth version 3.0 audio module, fully compatible with Bluetooth version 2.1 + EDR, 1.2, and 1.1
- Software configurable through commands over UART console interface
- Embedded Bluetooth stack profiles: SPP, A2DP, HFP/HSP, and AVRCP
- Enables Audio streaming from iPhone, iPod®, iPad® and Android smartphones and accessories
- Additional support for codecs such as aptX®, AAC, MP3, and others

RN52 Audio Bluetooth Evaluation Kit (RN-52-EK)



- Based on RN52 Bluetooth audio module
- Demonstrates key features of RN52 module for embedded systems
- Allows designers to develop prototypes and proof of concept
- USB port to supply power and access to command interface
- Built-in amplifier for stereo audio output and six function buttons

More information is available at: www.microchip.com/bluetooth.

PIC32 MCU Plus Bluetooth

PIC32 Bluetooth Starter Kit (DM320018)

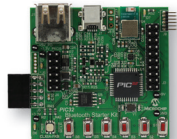

The PIC32 Bluetooth Starter Kit is a low-cost Bluetooth development platform featuring the PIC32MX270F256D MCU. This kit features an HCI-based Bluetooth radio, pushbuttons, Cree high-output multi-color LED, standard single-color LEDs, accelerometer, temperature sensor and GPIO for rapid development of Bluetooth data-based Serial Port Profile (SPP) applications.

PIC32 Multimedia Expansion Board II (DM320005-2)



The Multimedia Expansion Board II (MEB-II) is a highly integrated, compact and flexible development platform which works with the PIC32MZ Starter Kit.

- Low-cost Bluetooth HCI transceiver
- 24-bit stereo audio codec
- Integrated 802.11 b/g wireless module
- Optional EBI SRAM memory
- 4.3" WQVGA PCAP touch display daughter board
- microSD™ slot
- mTouch® sensing solutions buttons
- Analog temperature sensor
- VGA camera
- PICTail connector

www.microchip.com/wireless

Embedded Wireless Solutions

Targeting the Need for Low-Power Wireless Connectivity

PIC32 Bluetooth Audio Development Board (DV320032)



The PIC32 Bluetooth Audio Development kit provides a comprehensive solution to develop Bluetooth A2DP audio streaming applications.

- PIC32MX450/470 MCU
- HCI Bluetooth module Daughter Card (QDID-certified module)
- 16/24-bit, 32–192 kHz DAC/Amp Daughter Card
- USB Host/Device audio support
- USB charging
- 2 inch color LCD display
- Headphone/line out
- Audio control function

Bluetooth/USB Audio Software Support for:

- Apple® *
- Samsung™ audio
- Google®/Android AOA Audio
- Bluetooth Audio with SBC and AAC Decode
- Bluetooth Stack QDID-Certified

Microchip offers three Bluetooth audio software suites:

- PIC32 Bluetooth SBC only Audio Software Suite
- PIC32 Bluetooth SBC and AAC Decoder Audio Software Suite
- PIC32 Bluetooth Break-In Mode with SBC Audio Software Suite

The Advanced Audio Distribution Profile (A2DP), Audio/Video Remote Control Profile (AVRCP), Serial Port Profile (SPP), and Service Discovery Protocol (SDP)—provided in the binary form—are common to all the three suites. This Bluetooth binary code is combined with application source code for operation on the PIC32 Bluetooth Audio Development Kit (DV320032).

Additional software support is included in the latest version of suites for:

- Parametric and Graphical Equalizer functions
- User-configurable voice prompts
- User-configurable button press
- Removed RTOS requirement

*For Apple USB Authenticated applications contact applesupport@microchip.com.

XBee® -Compatible Wi-Fi and Bluetooth Socket Modules

Some designers want an easy way to migrate their 802.15.4 designs to either Wi-Fi or Bluetooth to make them accessible from smartphones and tablets or to add Internet connectivity. The RNXV series of Wi-Fi and Bluetooth socket modules provide agency-certified drop-in connectivity for any XBee socket. To simplify designs, the stacks are integrated on the module, configured via simple ASCII commands and can easily connect to any MCU via a serial interface.

Wi-Fi: RN171XV



- Direct Internet connectivity
- Full 802.11 b/g data rate support
- On-board TCP/IP stack
- SoftAP and infrastructure modes

Bluetooth: RN41XV/RN42XV



- Agency-certified Bluetooth module, supports version 2.1 + EDR
- UART (SPP) data connection interface
- Embedded Bluetooth stack profiles included: SPP, HID, HCI
- Multiple antenna options available: (RN41) Chip antenna, U.FL connector, (RN42) PCB trace antenna

ZigBee IEEE 802.15.4: (2.4 GHz)

MRF24XA, MRF24J40/MA/MC/MD Modules

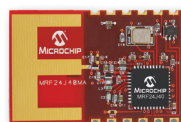

Microchip offers ZigBee-certified platforms for ZigBee PRO and ZigBee RF4CE protocol stacks, ensuring interoperability and reliable communication.

- ZigBee PRO Stack
- Smart Energy Profile
- ZigBee RF4CE and ZRC Profile
- 2.4 GHz IEEE 802.15.4 compatible transceivers and modules
- FCC, IC and ETSI agency certified
- Supports ZigBee and MiWi wireless networking protocol development environment

More information is available at www.microchip.com/zigbee.

Sub-GHz Solutions: (433/868/915/950 MHz)

MRF49XA/MRF89XA/M8A/M9A Modules



Microchip's Sub-GHz MRF modules are designed to bring simplicity to RF design along with regional regulatory certification. The modules target the lowest-cost proprietary radio link market and offer industry-leading characteristics including low power and large link budgets.

- 433/868/915/950 MHz transceiver and modules
- Low receive current = 3 mA
- Transmit power = +12.5 dBm
- Receiver sensitivity: -107 dBm FSK/-113 dBm OOK
- Integrated PCB antenna and matching circuit components
- FCC, IC and ETSI agency certified
- Surface-mountable PCB
- Supports MiWi wireless networking protocol development environment

Embedded Wireless Solutions

Targeting the Need for Low-Power Wireless Connectivity

MRF89XAM8A PICtail/PICtail Plus Daughter Board (AC164138-1) and MRF89XAM9A PICtail/PICtail Plus Daughter Board (AC164138-2)

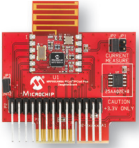

Targeted for the MiWi Protocol Development Environment and other proprietary wireless protocol applications, the MRF89XAM8A/9A PICtail/PICtail Plus Daughter Board is a demonstration and development daughter board for the MRF89XAM8A/9A, an ETSI-certified 868/915 MHz radio transceiver module. The module is surface mounted to a PICtail/PICtail Plus daughter board that plugs into multiple Microchip demonstration and development boards like the PICDEM™ PIC18 Explorer Board (DM183032) for 8-bit microcontroller development, or the Explorer 16 Development Board (DM240001) for 16-bit and 32-bit microcontroller development.

MRF24J40MA PICtail/PICtail Plus (AC164134-1)



The MRF24J40MA PICtail/PICtail Plus Daughter Board is a demonstration and development daughter board for the MRF24J40MA IEEE 802.15.4, 2.4 GHz RF Transceiver module. The daughter board plugs into multiple Microchip demonstration and development boards, including the PIC18 Explorer Board (DM183032) for 8-bit microcontroller development or the Explorer 16 Development Board (DM240001) for 16-bit and 32-bit microcontroller development.

MRF24XA PICtail/PICtail Plus Daughter Board (AC164152-1)



The MRF24XA PICtail/PICtail Plus Daughter Board is a demonstration and development daughter board for the MRF24XA low-power, 2.4 GHz, ISM-Band IEEE 802.15.4 RF Transceiver. The daughter board plugs into multiple Microchip demonstration and development boards, including the PIC18 Explorer Board (DM183032) for 8-bit microcontroller development or the Explorer 16 Development Board (DM240001) for 16-bit and 32-bit microcontroller development.

Integrated MCU + RF

Low-power Sub-GHz transmitters with PIC MCUs in a single package for remote keyless entry, garage door openers, remote control and other one-way communication applications.

- PIC12F529T48A/39A
- PIC12LF1840T48A/39A
- PIC16LF1824T39A

More information is available at: www.microchip.com/security.

MiWi Wireless Networking Protocol Development Environment

The MiWi Wireless Networking Protocol Development Environment is designed to provide a smaller-footprint, lower-resource communication protocol stack for peer-to-peer and mesh wireless networks. It is intended for customers who desire robust communication in a closed or private wireless network at either 2.4 GHz or Sub-GHz operation frequency.

- MiWi Wireless Networking Protocol P2P
- MiWi Wireless Networking Protocol
- MiWi Wireless Networking Protocol PRO

More information is available at: www.microchip.com/miwi.

MiWi Wireless Networking Protocol to Wi-Fi Wireless Demo Kit (DM182018)

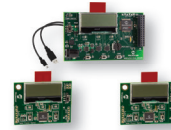

The MiWi Wireless Networking Protocol to Wi-Fi Wireless Demo Kit allows you to evaluate and experiment with MiWi wireless networking protocol to Wi-Fi gateway solutions. The kit includes a wireless evaluation board with both MiWi wireless networking protocol and Wi-Fi transceivers. It also includes two MiWi wireless networking protocol demo boards to create a three-node MiWi wireless networking protocol network. The MiWi Wireless Networking Protocol to Wi-Fi Demo Kit is pre-programmed with a wireless demo program, which demonstrates how to commission and control the MiWi wireless networking protocol P2P network from a web browser.

The Wireless Development Studio (WDS)

The WDS is a Java-based Graphic User Interface (GUI) which allows quick and easy development of wireless applications based on the MiWi wireless networking protocols. It features a MiWi wireless networking protocol sniffer for monitoring, debugging and gathering information and a configurator with a GUI to enable simple customization and configuration of wireless networks.

Development Tools

Remote Control Demo Board (DM240315-2)



This board integrates graphics, mTouch technology, USB and RF4CE into a single demo. It features the PIC24FJ256DA210 MCU, a 3.5" graphical TFT LCD with resistive touch screen, capacitive touch keys with plastic overlay, MRF24J40 2.4 GHz transceiver and ZENA™ wireless adapter.

USB Connectivity Solutions

Scalable Integrated USB Solutions

The consumers' desire for more engaging, easy-to-use and upgradeable products is driving embedded designers to add USB capabilities to their designs.

Microchip provides a scalable choice of integrated USB solutions across 8-, 16- and 32-bit PIC microcontrollers ranging from space-saving 14-pin devices to feature-rich 144-pin USB On-the-Go (OTG) products. This allows simple, compact designs to be easily expanded to offer more capabilities as requirements demand.

In addition, Microchip offers highly configurable standalone USB converters, hubs, transceivers, switches, bridges, security controllers and microcontrollers ideal for applications like digital audio, smartphones, Flash media controllers, power delivery and charging, cameras, GPS, gaming, medical devices, networking and set-top boxes.

Microchip provides free source code for USB software stacks and class drivers to shorten development time for USB applications, including thumb drive bootloaders and printer support. Supported classes include audio, CDC, HID, MSD, printer and custom. Microchip's free USB host stack, device stack and class drivers are available at: www.microchip.com/usb.

PIC16F and PIC18F Family

- Full-speed USB Device mode
- 8–128 KB Flash, 512B–4 KB of RAM,
- Up to 16 MIPS 8-bit devices
- Up to four UARTs, two I²C™/SPI ports
- Available in 14 to 100-pin packages
- Crystal-free options available

PIC24 Family

- Full-speed USB Device, Host and OTG modes
- 32–512 KB Flash, 8–96 KB RAM
- 16 to 70 MIPS 16-bit devices
- Up to four UARTs, three I²C and four SPI ports
- DMA interface for data RAM access, display drivers
- Available in 28/44/64/80/100/144-pin packages

PIC32MX Family

- Full-speed USB Device, Host and OTG modes with dedicated DMA Channels
- 16–512 KB Flash, 4–128 KB RAM
- 40, 50, 80 and 100 MHz MIPS® M4K® Core
- 10/100 Ethernet MAC with MII/RMII interface and up to two CAN 2.0B ports
- Up to six UARTs, five I²C, four SPI ports, two I²S™ and CTMU
- Up to eight general purpose DMA channels
- Available in 28/36/44/64/100/124-pin packages

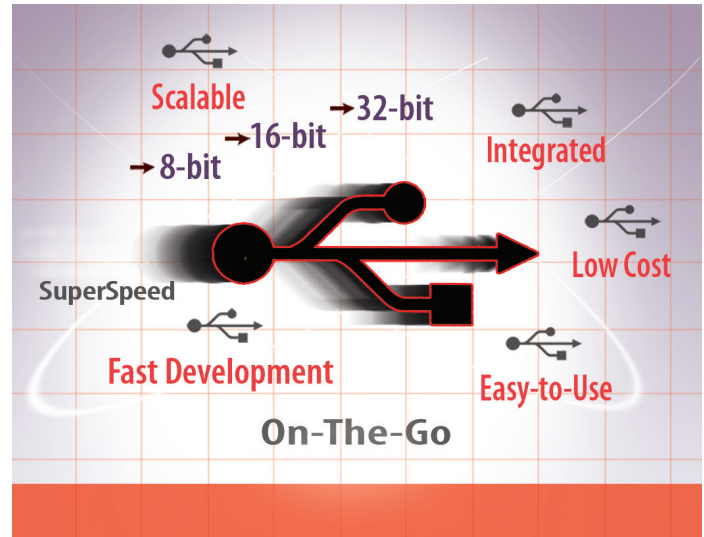

PIC32MZ Family

- High-speed USB 2.0 Device, Host and OTG modes with dedicated DMA Channels
- 1–2 MB Flash, 512 KB RAM
- 200 MHz microAptiv™ Core
- 10/100 Ethernet MAC with MII/RMII interface and up to two CAN 2.0B ports
- Up to six UARTs, five I²C, six SPI/I²S ports
- Up to eight general purpose DMA channels and up to 18 channels of dedicated DMA
- External Bus Interface (EBI), Serial Quad Interface (SQI) and Crypto Engine
- Available in 64/100/124/144-pin packages

dsPIC33E Family

- Full-speed USB Device, Host and OTG modes
- 256–512 KB Flash, 32–52 KB RAM, 70 MIPS 16-bit devices
- Four UARTs, two I²C and four SPI ports with motor control and digital power peripherals
- Available in 64/100/144-pin packages

Stand-alone USB Converters

- MCP2200 (USB to UART) and MCP2210 (USB to SPI) bridge devices allow for an easy and cost-effective way to add USB to existing designs. These highly-configurable products support full-speed, on-board EEPROM and up to nine GPIOs.

USB Connectivity Solutions

Stand-alone and Integrated USB Solutions from Low-Cost Devices to Complex SuperSpeed USB

USB technology can be found in practically all applications and markets—from consumer to industrial to automotive segments. The extreme proliferation of USB has even led to the adoption of the technology as a high-bandwidth embedded chip-to-chip interface. Microchip enables seamless USB connectivity by delivering integrated value-rich solutions such as USB hub controllers, power delivery and charging, transceivers/switches, Flash media controllers and security solutions.

USB Hub Controllers

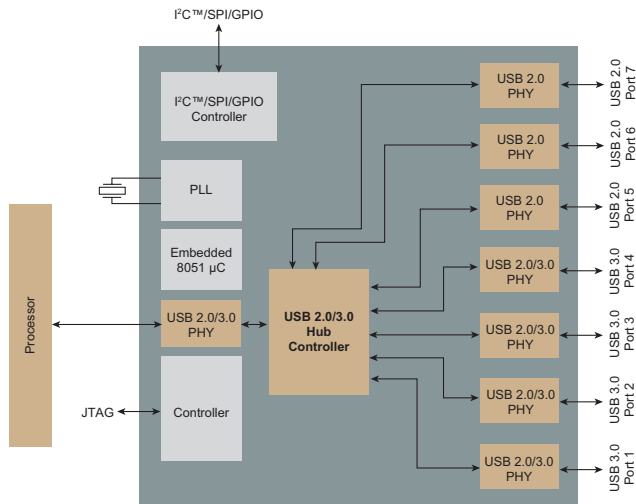

USB24XX/USB25XX/USB350X/USB380X/ USB3X13/USB553X Families

- USB-IF-compliant Hi-Speed USB 2.0 and SuperSpeed USB 3.0 solutions
- Integrated controller providing integrated, easy-to-use controller providing flexible programmability
- Small, highly-integrated and low-power hub solutions offered specifically for mobile applications
- Multi-port solutions with battery charger detection
- Unique system optimization features including PHYBoost, VariSense™ and flexConnect

USB Security

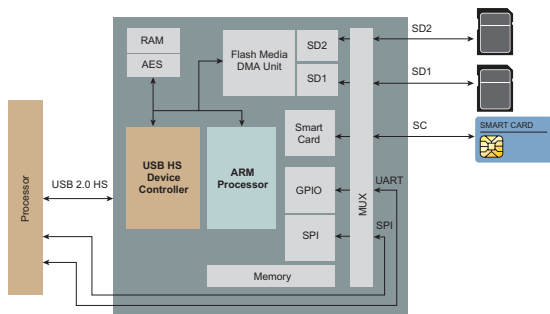

SEC11XX/SEC12XX/SEC24XX/SEC44XX Families

- Multiple standard smart card interfaces including ISO/IEC7816
- Flexible host interfaces supported including USB, SPI and UART
- Hardware-level key management and AES encryption
- Extremely fast, optimized and secure data transfers with no firmware intervention

USB Power Delivery and Battery Charging

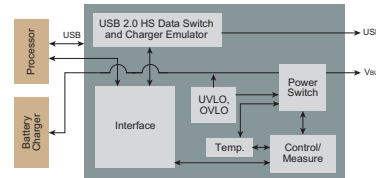

UCS100X Family

- Port power switch capable of supporting up to 2.5A for continuous current
- Up to nine preloaded charger emulation profiles with full programmability to customize profiles
- Integrated current sensor to optimize charging experience and algorithms
- Extremely low-power sleep mode

Note: UCS1002 may require an NDA.

USB Transceivers and Switches

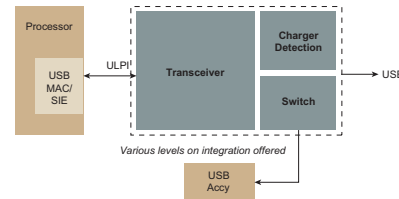

USB333X/USB334X/USB374X/USB375X Families

- ULPI-standard interface to transceivers
- Compliant Hi-Speed USB 2.0 switch technology for USB port sharing
- Battery charger detection integrated
- Smallest package option available, ideal for mobile applications

USB Flash Media Controllers

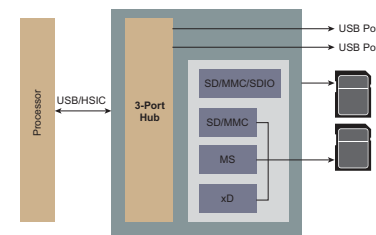

USB22XX/USB26XX/USB46XX Families

- Secure Digital (SD™)/microSD™, Embedded MultiMediaCard (eMMC™)/MultiMediaCard™ (MMC), Memory Stick® (MS)/MS Pro™/MS Pro-HG™, xD-Picture Card™ (xD)
- Card speed technology for maximum data throughput
- Integrated USB hub ports for highest integration
- Flexible interfaces to processor including USB and HSIC

www.microchip.com/usb

USB Development Tools and Software Support

Supporting USB Development from Concept to Prototype

Microchip's support for USB applications includes MPLAB® X Integrated Development Environment (IDE) tools for all USB PIC MCUs, peripheral applications for the 8-bit PIC16F and PIC18F families, and device, embedded host and OTG applications for the 16-bit PIC24F, PIC24E and dsPIC33E and 32-bit PIC32 families. Designers can use Microchip's free USB stacks—including class drivers, 16- and 32-bit file system drivers and SCSI interface drivers—which are provided in source code form. More information is available at: www.microchip.com/usb.

Additional software support includes full C and RTOS development environments. Also available are TCP/IP stacks, graphics libraries and ZigBee software stacks, which allow USB functionality to be combined with other capabilities to support a variety of designs. More information is available at: www.microchip.com/mla. More information about USB Software for PIC32 is available at: www.microchip.com/harmony.

USB Starter Kits

These development kits provide an easy, low-cost way to evaluate the functionality of Microchip's 8-, 16- and 32-bit USB microcontrollers. Each all-inclusive kit contains the hardware, software and code examples necessary to take your next USB design from concept to prototype.

Low Pin Count USB Development Kit (DV164127-2)

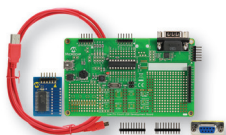

This is a development kit for PIC16F145X, PIC18F14K50 and PIC18F13K50 14- and 20-pin USB microcontrollers. Included in the kit are PIC MCU samples, code examples and all necessary

hardware and software.

PIC18 Starter Kit (DM180021)



This kit features a PIC18F46J50 MCU and includes on-board debugger/programming capability as well as USB communication, a capacitive touch pad, potentiometer, acceleration sensor, MicroSD

memory card and an OLED display. The board can function as a USB mouse, joystick or mass storage device (thumb drive) all using the on-board capacitive touch sense pads.

MPLAB Starter Kit for PIC24F (DM240011)



This kit provides an inexpensive way to evaluate the 16 MIPS PIC24FJ256GB110 with USB-OTG. Application demonstrations include mTouch capacitive sensing, driving an

OLED display and USB-OTG to store data to a thumb drive.

PIC32 USB Starter Kit II (DM320003-2)



This kit provides the easiest and lowest-cost method to experience the USB and CAN functionality of PIC32 microcontrollers. You can develop CAN applications using PIC32 expansion boards. The board contains everything you need to develop USB embedded Host/

Device/OTG applications when combined with Microchip's free USB software.

MPLAB Starter Kit for PIC24F Intelligent Integrated Analog (DM240015)

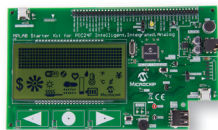

The MPLAB Starter Kit for PIC24F Intelligent Integrated Analog is a stand-alone board showcasing the advantages of lower BOM cost, faster throughput and lower noise analog, and features an on-board programmer/debugger. The board demonstrates these features of the PIC24FJ128GC010 Microcontroller: direct LCD drive, 16-bit Sigma-Delta ADC, 12-bit Pipeline ADC, 10-bit DAC, op amps, CTMU, DMA, USB and XLP low power consumption.

PIC32 USB Starter Kit III (DM320003-3)

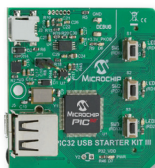

The PIC32 USB Starter Kit III provides you with an easy and cost-effective option to experience the USB, mTouch and SPI/I²S functionality of PIC32MX3/MX4 microcontrollers. The board comes equipped with everything that is needed to develop USB embedded host/device/OTG applications, including Microchip's free USB software.

Note: Additional PIC32 Starter Kits that support USB and Ethernet are listed in the Ethernet Development Tools section.

FS USB Plug-In Module (PIM) Demo Boards

These full-speed USB demonstration and development boards feature the PIC18FXXJ50 8-bit MCUs. The boards can be operated either stand-alone or as a PIM plugged into the PICDEM PIC18 Explorer board (DM183032).

PIC18F46J50 FS USB PIM Demo Board (MA180024) PIC18F47J53 FS USB PIM Demo Board (MA180029)

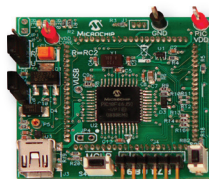

The PIC18F46J50 and PIC18F47J53 FS USB PIM demo boards are full-speed USB demonstration and development boards featuring the PIC18F46J50 and PIC18F47J53 respectively.

PIC18F87J94 FS USB Demo Board (MA180033)

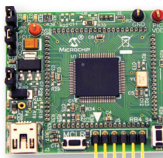

The PIC18F87J94 FS USB PIM demo board is a full-speed USB demonstration and development board featuring the PIC18F87J94.

www.microchip.com/usb

USB Development Tools and Software Support

Supporting USB Development from Concept to Prototype

Explorer 16 Development Platform

Combine the Explorer 16 low-cost modular development board with the USB PICtail Plus daughter board for easy USB development with 16- and 32-bit MCUs. Several different PIMs are available to allow development with a variety of MCU platforms.

Explorer 16 Development Board (DM240001)

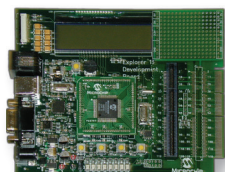

Use this efficient, low-cost development board to evaluate the features and performance of Microchip's 16-bit PIC24F and PIC24H MCU, dsPIC33 DSC and 32-bit PIC32MX families. Interface with the MPLAB ICD 3 In-Circuit Debugger or MPLAB REAL ICE™ In-Circuit Emulator to speed evaluation and prototyping of application circuitry.

USB PICtail Plus Daughter Board (AC164131)



This module enables USB hardware connectivity when using an Explorer 16 and USB-capable PIM. It provides support for USB Device, Host and OTG development.

Plug-In Modules



Various PIMs are available for use with the Explorer 16 Development Board. Individual PIMs feature different PIC24F, PIC24E and PIC32 microcontrollers and dsPIC33E digital signal controllers with USB modules.

USB Evaluation Boards

MCP2210 Evaluation Kit (ADM00421)



The MCP2210 Evaluation Kit is a development and evaluation platform for the MCP2210 USB-to-SPI stand-alone device.

USB Hub Controller Evaluation Boards

USB3613/USB3813 Mobile Hi-Speed USB 2.0 Programmable 3-Port Controller Hub (EVB-USB3613/EVB-USB3813)



The EVB-USB3613 and EVB-USB3813 are used to evaluate the USB31X13 family of programmable controller hubs for mobile applications. The difference between the USB3613 and the USB3813 is the upstream port—USB3613 has an HSIC interface, and the USB3813 has a USB interface. Both versions are offered in an extremely small package.

USB4604 Hi-Speed USB 2.0 Programmable 4-Port Controller Hub with FlexConnect and I/O Bridging (EVB-USB4604)



The EVB-USB4604 is used to evaluate the full-featured USB46X4 family of programmable controller hubs. It features full programmability and unique features such as FlexConnect and I/O Bridging.

USB2534 Hi-Speed USB 2.0 Programmable 4-Port Controller Hub (EVB-USB2534)

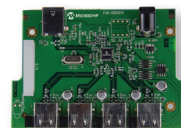

The EVB-USB2534 is used to evaluate the USB253X family of programmable controller hubs. This solution not only provides the flexibility to optimize hub functionality, but also integrates LPM power savings and USB battery charger detection on all ports.

USB2514B Hi-Speed USB 2.0 Multi-TT 4-Port Hub with Battery Charging Support (EVB-USB2514BC)

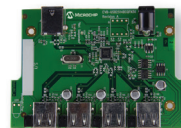

The USB2514B MultiTRAK™ Hub Controller is a low-power, full-featured, OEM-configurable Hi-Speed USB 2.0-compliant hub with four downstream ports. Each of these downstream ports in the USB2514B device is capable of supporting battery charging per the USB Battery Charging Specification.

USB3503 HSIC to USB 2.0 3-Port Hub for Portable Applications (EVB-USB3503)



The EVB-USB3503 is used to evaluate our extremely small-size USB3503 hub which is ideal for portable applications. Many processors serving the mobile market have adopted HSIC as a standard interface, and this solution allows for both external USB 2.0 connectivity as well as an embedded interface in mobile products.

USB3803 Hi-Speed USB 2.0 3-Port Hub for Portable Applications (EVB-USB3803)



The EVB-USB3803 is used to evaluate our extremely small-size USB3803 hub, which is ideal for portable applications. The USB3803 is similar to the USB3503 except that this device has a USB 2.0 upstream interface instead of HSIC. Some system architects prefer to use USB 2.0 and this solution provides an adaptable equivalent.

USB553X SuperSpeed USB 3.0 7-Port Hub Controller (EVB-USB5537)



The EVB-USB5537 is used to evaluate the USB553X family of SuperSpeed USB 3.0 hub controllers. This solution is offered in different port configurations and provides some unique features such as PHYBoost and VariSense to optimize USB system design. It also incorporates battery charging detection on all downstream USB ports.

www.microchip.com/usb

USB Development Tools and Software Support

Supporting USB Development from Concept to Prototype

Power Delivery and Battery Charging Evaluation Boards

USB Port Power Controller with Charger Emulation (ADM00497)

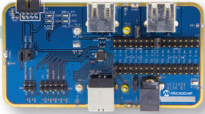

The EVB-UCS1002 is used to evaluate our UCS100X USB Port Power Controller solutions. USB ports are used for not only USB data, but also for USB battery charging. The UCS100X

provides up to nine preloaded and one programmable charger emulation profiles, an integrated current sensor and a power switch. It is capable of up to 2.5A of continuous current.

Note: The UCS1002 may require an NDA.

Transceiver/Switch Evaluation Boards

USB3330 Hi-Speed USB 2.0 Transceiver with ULPI Interface in Smallest Package (EVB-USB3330)



The EVB-USB3330 is used to evaluate our USB333X family of small, highly-integrated USB 2.0 transceivers with ULPI interface.

The small WLCS package makes the USB333X family an ideal solution for

mobile and portable applications. It features multi-frequency reference clocks to adapt and share any common system reference clocks, and includes key features like RapidCharge Anywhere™, PHYBoost and VariSense for system optimization.

USB3340 Hi-Speed USB 2.0 Transceiver with ULPI Interface (EVB-USB3340)



The EVB-USB3340 is used to evaluate our USB334X family of highly integrated USB 2.0 transceivers with ULPI interface. The features and functions are identical to the USB333X family except the USB334X

comes in a convenient, widely-used 32-pin QFN package.

USB3740 Hi-Speed USB 2.0 2-Port Switch (EVB-USB3740)

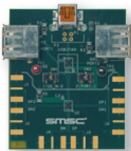

The EVB-USB3740 is used to evaluate our USB3740 USB 2.0 compliant 2-port switch. Some applications require a single USB port to be shared with other functions. The USB3740 is a small and simple 2-port switch providing system design flexibility.

USB375X Hi-Speed USB 2.0 Port Protection with Integrated Switch and Charger Detection (EVB-USB3750)



The EVB-USB3750 is used to evaluate our USB375X family of Integrated USB 2.0 Port Protection devices. The USB375X integrates a high level of ESD

protection to the USB port, which is typically exposed to the harsh environment of the outside world. It also incorporates our Hi-Speed USB 2.0 switch as well as battery charger detection, all in a conveniently small package.

Flash Media Controller Evaluation Boards

USB2250 Ultra Fast Hi-Speed USB 2.0 Multi-Slot Flash Media Controller Evaluation Board (EVB-USB2250)



The EVB-USB2250 is used to demonstrate the features of the USB2250, a stand-alone Hi-Speed Mass Storage Class Peripheral Controller intended for reading and writing to

more than 24 popular Flash media formats from the CompactFlash® (CF), SmartMedia™ (SM), xD-Picture Card (xD), Memory Stick (MS), Secure Digital (SD) and MultiMediaCard (MMC) families.

USB2640 USB 2.0 Port Hub with Ultra-Fast Flash Media Controller Evaluation Board (EVB-USB2640)



The USB2640 is an Ultra-Fast USB 2.0 Hub, Flash media controller and protocol bridge combo. The EVB-USB2640 Evaluation Board demonstrates a stand-alone application for developers of applications such

as Flash media card reader/writer, printers, desktop and mobile PCs, consumer A/V and flat panel displays.

USB4640 HSIC 1.0 to USB 2.0 2-Port Hub with Ultra-Fast Flash Media Controller Evaluation Board (EVB-USB4640)



The EVB-USB4640 Evaluation Board is for the USB4640 Hi-Speed HSIC USB hub and card reader combo solution. It has an upstream port compliant to HSIC 1.0 using dual UFL connectors, a supplement to the USB 2.0 specification.

Security Evaluation Boards

Smart Card Controllers with Flexible Interface Support (EVB-SEC1210)



The EVB-SEC1210 is used to evaluate our SEC11XX/SEC12XX family of security products. These solutions' flexible host interface options include USB, SPI or UART and provide either single or dual smart card interfaces to ISO/IEC7816 specifications.

Hi-Speed USB 2.0 Flash Media Controller with AEC Encryption and Integrated Smart Card Reader (EVB-SEC2410-SSD)



The EVB-SEC2410-SSD is used to evaluate our SEC24XX/SEC44XX family of Flash Media Controller

Security products. Hardware-level key management and AES encryption, as well as the high-performance hardware controller-Flash media data transfers—which require no firmware intervention—are fundamental features of these solutions.

www.microchip.com/usb

Ethernet Connectivity Solutions

Complete Portfolio of Ethernet Products for Flexibility of Design

A wide range of remote communication features are possible when Ethernet connectivity is added to embedded designs. For example, systems can be remotely monitored using a web browser or an email notification can be sent, triggered by service alerts or low product inventory. End users benefit from cost and time savings since they can centrally monitor, control and service their embedded systems over the Internet instead of being physically present.

The Microchip Ethernet portfolio includes 10/100 Mbps and 10/100/1000 Mbps transceivers as well as 2- and 3-port switches and integrated Ethernet controllers. These Ethernet products include enhanced features such as Energy Efficient Ethernet (IEEE 802.3az), Wake-on-LAN and cable diagnostics to bring high-performance connectivity to all your embedded designs.

Microchip's Ethernet solutions address the growing demand for embedded Ethernet products, enabling easy network connectivity for cost-sensitive embedded designs.

- Free and robust TCP/IP stack optimized for the PIC18, PIC24 and PIC32 microcontroller and dsPIC® digital signal controller families
- Supported protocols include HTTP, SMTP, SNMP, FTP, SNT, SSL, TCP, UDP, IP, DHCP, DDNS, ICMP and ARP

PIC18F97J60 Ethernet PIC Microcontroller

- PIC18F microcontroller with built-in Ethernet MAC and 10Base-T PHY
- 8 KB dedicated Ethernet Buffer RAM
- Up to 128 KB Flash
- Advanced analog and communication peripherals
- Available in 64-, 80- and 100-pin TQFP packages

PIC32MX6XX, PIC32MX7XX Ethernet PIC Microcontrollers

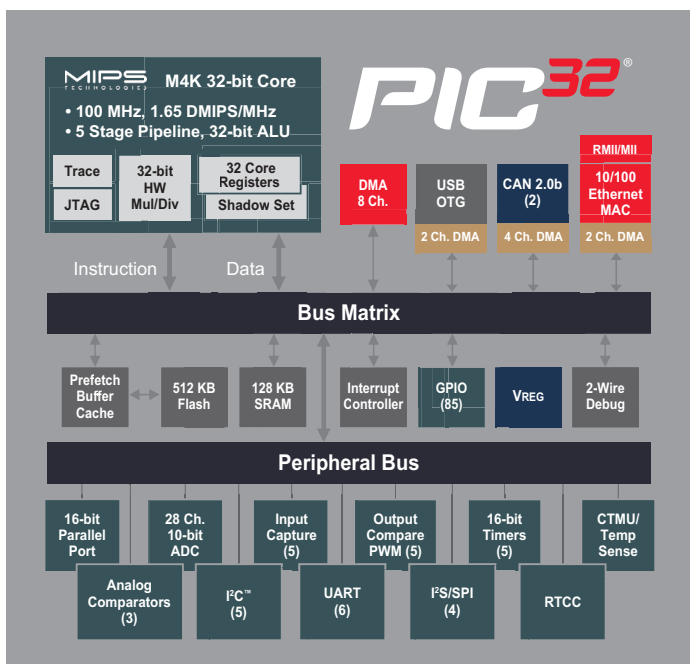

- Integrated 10/100 Mbit Ethernet MAC
- Dedicated DMA interface for direct access to the entire system RAM
- Industry-standard RMII/MII interface to PHY
- Pre-programmed MAC address
- 80 MHz, up to 512 KB Flash, up to 128 KB RAM
- Available in 64-pin (TQFP, QFN) and 100-pin (TQFP, BGA) packages

PIC32MZ Embedded Connectivity PIC Microcontrollers

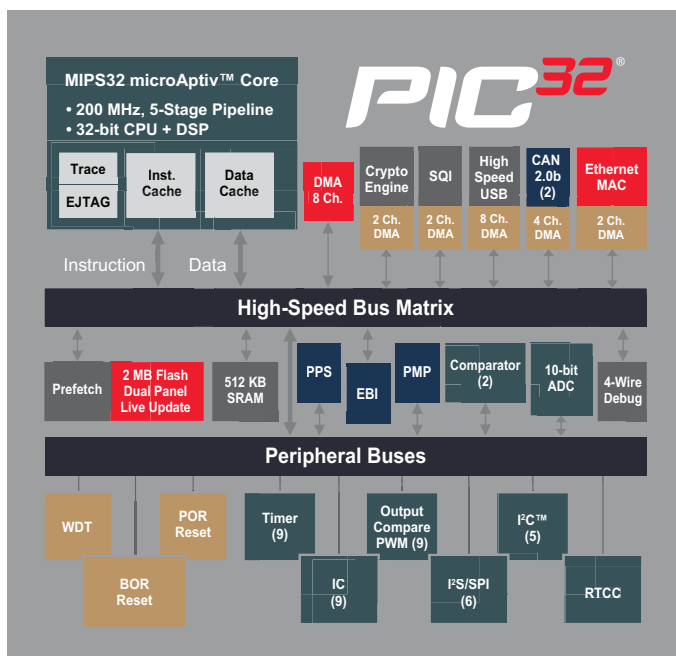

- Integrated 10/100 Mbps Ethernet MAC
- Dedicated DMA interface for direct access to the entire system RAM
- Industry-standard RMII/MII interface to PHY
- Pre-programmed MAC address
- High-speed USB, CAN 2.0B, Crypto Engine, SQI and EBI ports
- 200 MHz, 1–2 MB Flash and 512 KB RAM
- Available in 64-pin (TQFP, QFN), 100-pin (TQFP), 124-pin (VTLA) and 144-pin (TQFP, LQFP) packages

Ethernet Connectivity Solutions

Complete Portfolio of Ethernet Products for Flexibility of Design

ENC624J600, ENC424J600 Embedded Ethernet Controllers

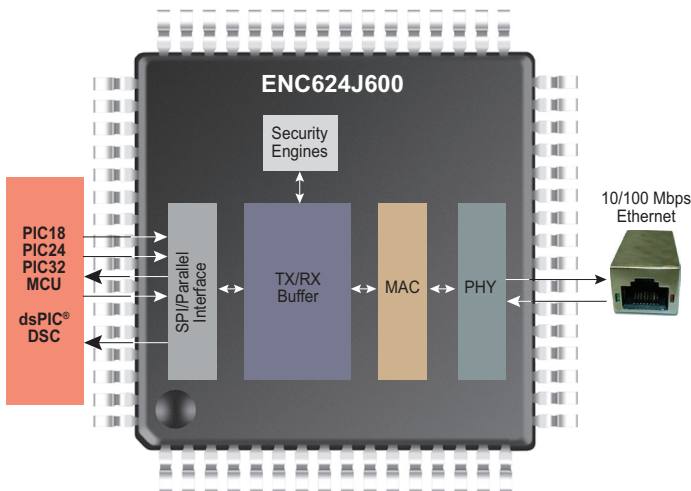

- Integrated MAC and 10/100Base-T PHY
- 24 KB transmit/receive buffer SRAM
- MCU Interface supported: SPI and 8/16-bit parallel
- Cryptographic Security Engines
- Pre-programmed unique MAC address
- Available in 44-pin (TQFP, QFN) and 64-pin (TQFP) packages

ENC28J60 Embedded Ethernet Controller

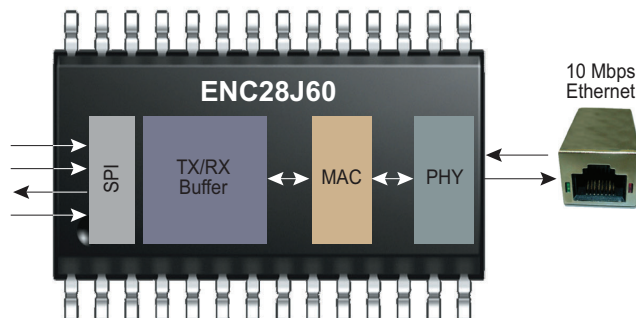

- Integrated MAC and 10Base-T PHY
- 8 KB transmit/receive buffer SRAM
- MCU Interface Supported: SPI
- Available in 28-pin SPDIP, SSOP, SOIC and QFN packages

MAC Address Chips

- Pre-programmed EUI-48™ and EUI-64™ node address
 - Up to 1.5 Kb Serial EEPROM functionality
- SPI: 25AA02E48
I²C: 24AA02E48
UNI/O® : 11AA02E48
www.microchip.com/MAC

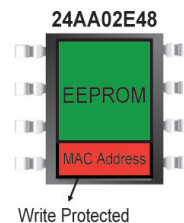

Ethernet Connectivity Solutions

Complete Portfolio of Ethernet Products for Flexibility of Design

Ethernet devices have become ubiquitous in communications and networking products servicing a wide variety of applications across multiple market segments. This well-understood technology provides a robust link to ensure reliable communication between devices in a network. Microchip has a broad portfolio of reliable, high-quality, and high-performance Ethernet solutions. From Ethernet switches, controllers, bridges and PHYs to a variety of standard interfaces serving consumer, industrial and automotive applications, Microchip can provide a solution to address your varied application needs and offers you the support needed to reduce your time-to-market.

Ethernet Switches

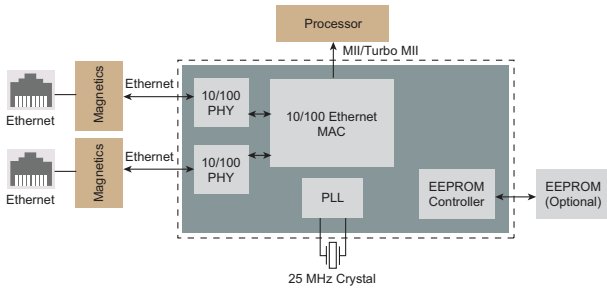

LAN93XX Family

- High-performance, full-featured 3-port switches with per-port 802.1Q VLAN support (up to 16 VLAN groups)
- Excellent ESD protection (+8 kV/15 kV) per port
- IGMP v1/v2 monitoring for multicast packet filtering
- Up to 200 Mbps network speed via Turbo MII interface
- Virtual PHY feature simplifies software development by mimicking multiple switch ports as a single port PHY

Ethernet Controllers

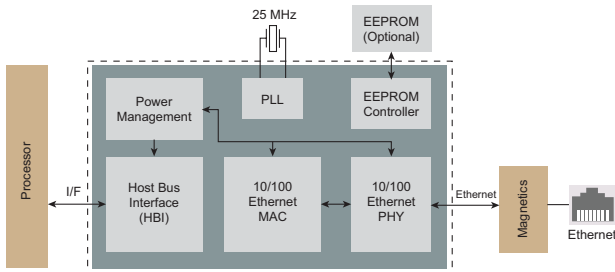

LAN92XX/LAN94XX and ENC Families

- Single-chip Ethernet controllers with integrated MAC and PHY
- Flexible interfaces supported (16/32-bit local bus, PCI, MII, high speed SPI, parallel)
- Efficient architecture to minimize CPU overhead
- Integrated checksum offload engine
- Conforms with 802.3/802.3u industry standards
- HP Auto-MDIX support

Ethernet Bridges (USB to Ethernet)

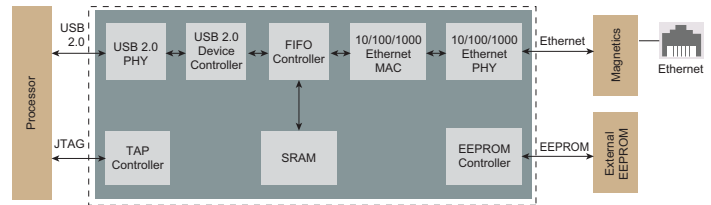

LAN7500 and LAN95XX/97XX Families

- USB 2.0 to 10/100 and 10/100/1000 Ethernet products
- Flexible interfaces supported (USB 2.0, HSIC)
- Integrated USB, Ethernet MAC and PHY for lowest BOM cost and size
- Multi-port support for USB port expansion
- Supports numerous power management features including Wake-on-LAN, Magic Packet™, and Link Status Change
- Software compatibility – transparent to USB software stack and device drivers

Ethernet PHYs

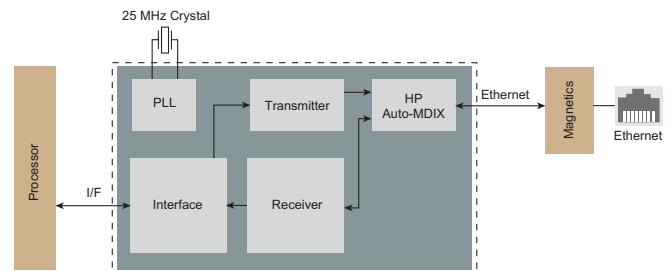

LAN87XX and LAN88XX Families

- 10/100 and 10/100/1000 transceivers with support for all industry-standard interfaces (MII, RMII, GMII, RGMII)
- Comprehensive flexPWR® technology to provide flexible options to minimize power consumption
- Energy Efficient Ethernet (802.3az) support
- Deterministic latency to provide the most reliable and predictable link
- Wake-on-LAN support

Ethernet Development Tools

Supporting Ethernet Development from Concept to Prototype

Development Tools Support

PICDEM.net 2 Development Board (DM163024)

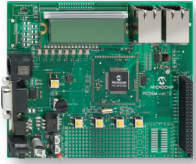

This Ethernet development board supports both the ENC28J60 controller and the PIC18F97J60 MCU. With this board and Microchip's free TCP/IP stack, a web server can be developed showcasing the capability to remotely monitor and control embedded applications over the Internet.

PIC32 Ethernet Starter Kit II (DM320004-2)

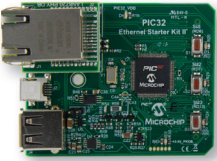

This board provides the easiest and lowest-cost method to experience 10/100 Ethernet development with PIC32 microcontrollers. Combined with Microchip's free TCP/IP software, this kit gets your project running quickly. It features a socket that can accommodate 10/100 Ethernet transceiver (RJ-45) PHY Daughter Boards for prototyping and development.

Fast 100 Mbps Ethernet PICtail Plus Daughter Board (AC164132)

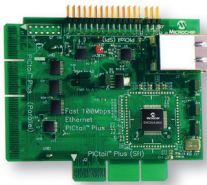

Populated with the ENC624J600, this Ethernet board interfaces to the RJ-45 connector. It can be plugged into the Explorer 16 Development Board (DM240001) and the PIC18 Explorer Board (DM183032) allowing connection to any of Microchip's 8-, 16- and 32-bit products.

Ethernet PICtail Plus Daughter Board (AC164123)



This board is populated with the 28-pin ENC28J60 Ethernet controller which interfaces to the RJ-45 connector. It can be plugged into the Explorer 16 Development Board (DM240001), allowing connection to any of Microchip's 16- and 32-bit products when used in conjunction with the free Microchip TCP/IP stack.

PIC32MZ Embedded Connectivity Starter Kit (DM320006)

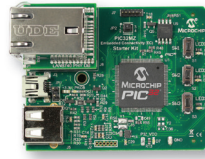

This board provides the easiest and lowest-cost method to experience the high performance and advanced peripherals integrated in the PIC32MZ Embedded Connectivity MCUs. This starter kit features a socket that can accommodate 10/100 Ethernet transceiver (RJ-45) PHY Daughter Boards for prototyping and development.

PIC32MZ Embedded Connectivity Starter Kit with Crypto Engine (DM320006-C)

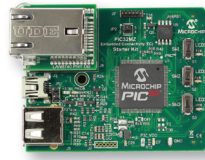

This board provides the easiest and lowest-cost method to experience the high performance and advanced peripherals integrated in the PIC32MZ Embedded Connectivity MCUs. It features the PIC32MZ2048ECM144 with on-board crypto engine for encryption, decryption, and authentication and has a socket that can accommodate 10/100 Ethernet transceiver (RJ-45) PHY Daughter Boards for prototyping and development.

LAN8720A PHY Daughter Board (AC320004-3)

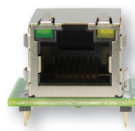

The LAN8720A PHY Daughter Board is populated with the high-performance, small-footprint, low-power 10Base-T/100Base-TX Ethernet LAN8720A PHY. It is designed for easy development of RMII Ethernet control applications when plugged into the PIC32-compatible starter kits listed below:

- PIC32MZ Embedded Connectivity Starter Kit (DM320006)
- PIC32MZ Embedded Connectivity Starter Kit with Crypto Engine (DM320006-C)
- PIC32 Ethernet Starter Kit II (DM320004-2)

Ethernet Development Tools

Supporting Ethernet Development from Concept to Prototype

Ethernet Controller Evaluation Boards

LAN921X High-Performance 10/100 Ethernet Controller (EVB-LAN9218I-MINI)



The EVB-LAN9218I-MINI is used to evaluate our LAN921X family of high performance 10/100 Ethernet Controllers. These devices are designed to provide optimal performance and minimized CPU overhead. This evaluation board comes with our LAN9218 which has a full 32-bit interface.

LAN922X High Performance 10/100 Ethernet Controller with Variable Voltage I/O (EVB-LAN9221-MINI)



The EVB-LAN9221-MINI is used to evaluate our LAN922X family of high-performance 10/100 Ethernet Controllers. Similar to the LAN921X family, this solution features a high-performance architecture and minimizes

CPU overhead, but also provides a variable voltage I/O feature which allows it to interface with processors requiring a lower I/O voltage.

Ethernet Switches Evaluation Boards

LAN9303/LAN9303M 10/100 Managed 3-Port Ethernet Switch (EVB9303/EVB9303M)



The EVB9303/EVB9303M is used to evaluate our LAN9303 or LAN9303M solutions. Both products are 10/100 3-Port Managed Ethernet Switches which support MII/RMII/Turbo MII interfaces. The solutions can be

adapted to support different system architectures.

LAN931X 10/100 3-Port Ethernet Switch with Flexible interfaces (EVB-LAN9313M)



The EVB-LAN9313M is used to evaluate our LAN931X family of 10/100 3-Port Ethernet Switches which support various host interfaces. The solutions can be adapted to support different system architectures.

Ethernet Bridge Evaluation Boards

LAN9500A Hi-Speed USB 2.0 to 10/100 Ethernet Bridge Controller (EVB-LAN9500A-MII/EVB-LAN9500A-LC)

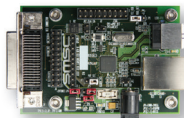

The EVB-LAN9500A-MII is used to evaluate our LAN9500A Hi-Speed USB 2.0 to Fast Ethernet Bridge Controller solution. Using an existing USB port with our LAN9500A allows you to add Ethernet connectivity to your system architecture.

LAN7500 Hi-Speed USB 2.0 to Gigabit Ethernet Bridge Controller (EVB-LAN7500)



The EVB-LAN7500 is used to evaluate our LAN7500 Hi-Speed USB 2.0 to Gigabit Ethernet Bridge Controller solution. If your system architecture requires Ethernet connectivity, you can use an existing USB port with our LAN7500 to achieve this requirement. A USB dongle version is also available (EVB-LAN7500-LC).

LAN9512/LAN9514 Hi-Speed USB 2.0 to 10/100 Ethernet Hub Customer Evaluation Board (EVB9514)



The EVB9514 is an evaluation board that utilizes the LAN9514 to provide a 4-port USB 2.0 hub with an integrated 10/100 Ethernet controller. The EVB9514 provides USB connectivity via one type B upstream USB

connector and four type A downstream USB connectors. The EVB9512 is also available for evaluation of the LAN9512.

LAN9730 Hi-Speed USB 2.0 HSIC to 10/100 Ethernet Bridge Controller (EVB-LAN9730-MII)



The EVB-LAN9730-MII is used to evaluate our LAN9730 Hi-Speed USB 2.0 HSIC-interface to Fast Ethernet Bridge Controller solution. Some system architects prefer to use their

HSIC ports to reduce power consumption. The LAN9730 adds Ethernet functionality via the HSIC port.

Ethernet Development Tools

Supporting Ethernet Development from Concept to Prototype

Ethernet Transceiver/PHY Evaluation Boards

LAN874X 10/100 Ethernet Transceiver with EEE and Wake-On-LAN (EVB8740)



The EVB8740 is a PHY evaluation board for our LAN874X family which integrates Energy Efficient Ethernet (EEE) and Wake-on-LAN features.

It interfaces to a MAC controller via a standard MII or RMI2 interface.

Third Party Development Tools

WIZnet W5200 Ethernet PICtail Board (TWIZ5200)



WIZnet's W5200 Ethernet PICtail Plus Board provides 10/100 Mbps, half/full duplex Ethernet connectivity via the on-board WIZnet W5200 Ethernet controller, which has a hardwired TCP/IP

processing engine. It works with Explorer 16, PIC32 I/O Expansion Board, PICDEM.net 2, PIC18 Explorer and other development boards. It supports both Microchip's software TCP/IP Stack and WIZnet's hardwired TCP/IP Stack on PIC18, PIC24, PIC32 MCU and dsPIC DSC platforms.

Serial Gateway to Ethernet P801 (10/100Base-T) (TIPL801)



The IPACK P-801 Gateway from IPLogika is a powerful Serial-to-Ethernet gateway that adds quick, effortless and full 10/100Base-T Ethernet connectivity to client applications. It has all the necessary physical and logical levels

for Ethernet connections, making integration with the host computer very convenient and easy.

LIN Bus Solutions

Scalability and Integration for the Low-Cost Communications Network

Local Interconnect Network (LIN)

LIN/J2602 is a communication standard designed to address low-cost networking within vehicles. LIN enables a cost-effective communication network for lower-speed switch, smart sensor and actuator applications within the vehicle where the bandwidth and versatility of CAN is not required. LIN can be implemented on any PIC microcontroller (MCU) with a UART or USART interface. Microchip also offers a robust physical layer interface, data link layer implementation, LIN-compliant drivers and a variety of development resources.

Stand-alone LIN Transceivers

The MCP2003/4(A) family offers stand-alone LIN transceiver options. Both parts meet LIN bus specification versions 1.3, 2.0 and 2.1 and SAE J2602. The transceivers' EMC/ESD performance is among the best in the industry and meets all automotive requirements. The MCP2003A is available in an industry-standard 8-pin SOIC package. The MCP2004A offers a TXE/Fault pin which allows you to disable the transmitter and provides data related to a fault condition.

LIN Transceivers with Integrated Voltage Regulator

The MCP2021A/2A and MCP2025 integrate a LIN transceiver and a 3.3V or 5V internal voltage regulator with a maximum output current of 70 mA. The devices support the LIN bus specification versions 1.3, 2.0 and 2.1 and SAE J2602 and are designed to meet the stringent EMC/ESD requirements of the world's auto makers.

Microchip also offers the MCP2050 LIN Transceiver with Voltage regulator, windowed watchdog timer and ratio metric V_{BAT} pin that allows for monitoring battery levels using a MCU A/D converter.

Integrated Microcontroller with LIN Transceiver and Voltage Regulator

The PIC16F1829LIN is a small-footprint MCU + V_{REG} + LIN Transceiver in a single package. Combining the flexible PIC16F1829 microcontroller with the powerful MCP2021A LIN transceiver enables a complete solution for LIN nodes and endpoints, compatible with LIN Specification versions 1.3, 2.0, 2.1, and SAEJ2602.

LIN Software Library

LIN Data Link Layer firmware can be downloaded free-of-charge from Microchip's web site. Many third-party companies also offer LIN Data Link Layer firmware, providing additional design options.

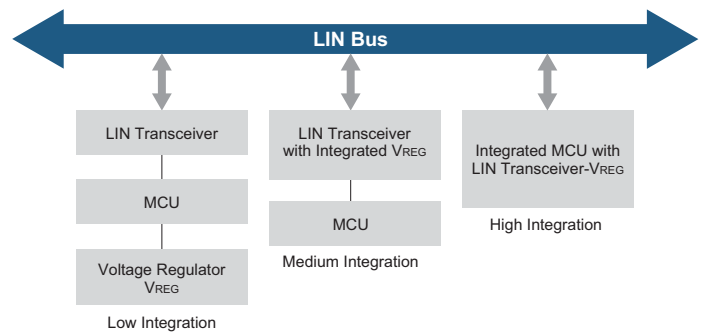

LIN Development Tools

LIN Serial Analyzer Development System (APGDT001)



The LIN Analyzer Development Tool enables a PC to communicate with the LIN bus. The PC program uses a graphical user interface to enter and display message frames occurring on the target bus, allowing for easy debug. It can also be used

as an active node on a bus to send and receive messages, therefore reducing the application development time.

CAN/LIN PICTail Plus Daughter Board (AC164130-2)



This daughter board can be used with the Explorer 16 Development Board and various PIMs featuring 16- and 32-bit MCUs with CAN peripherals, or the PIC18 Explorer Board with the PIC18F66K80

PIM to facilitate rapid implementation and evaluation of CAN and LIN applications.

PICKit 28-pin LIN Demonstration Board (DM164130-3)

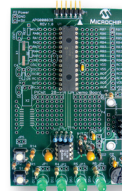

The PICKit 28-pin LIN Demonstration Board enables a quick start in developing and debugging applications with the LIN drivers. The kit includes a 28-pin socket which supports various PIC16F devices, a LIN transceiver plus a generous prototype area with various indicator LEDs and buttons to support testing and debugging of an application.

PICDEM CAN-LIN 3 Demonstration Board (DM163015)

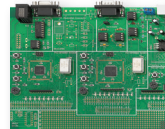

The PICDEM CAN-LIN 3 Demonstration Board provides an easy way to discover the power of Microchip's CAN and LIN products. The board demonstrates the main features of the 64-pin TQFP PIC18F6680 and 80-pin TQFP PIC18F8680 devices, including those features of the integrated CAN module. In addition, the board employs a LIN sub-network using Microchip's 20-pin SSOP PIC18F1320 and MCP201 LIN Bus.

CAN Bus Solutions

Taking Communication and Connectivity in Deeply-Embedded Designs to the Next Level

Controller Area Network (CAN)

CAN is a serial communication protocol used extensively for high-speed embedded applications where noise immunity and robustness is necessary. The CAN protocol supports speeds up to 1 Mbps and is highly fault-tolerant, making it ideal for safety-critical applications.

Microchip offers a complete line of products to meet the needs of high-performance embedded applications using the CAN protocol, including 8-, 16- and 32-bit microcontrollers and 16-bit digital signal controllers with integrated CAN, stand-alone CAN controllers, I/O expanders and CAN transceivers.

CAN MCUs and DSCs

The 8-bit PIC18F66K80 family offers the industry's best Sleep current of less than 20 nA, a wide operating voltage range of 1.8 to 5.5V and an advanced touch sensing interface. The 16-bit PIC24 and dsPIC33 families offer higher-density Flash memories and high-temperature operation of up to 150°C ambient. The 32-bit PIC32 family offers higher performance and better peripheral integration like Ethernet and USB.

At the heart of Microchip's CAN offering is the enhanced CAN module offered on many Microchip microcontrollers. Key features include:

- CAN 1.2, CAN 2.0A and CAN 2.0B support
- 32 buffers for TX/RX
- 32 acceptance filters
- Four acceptance mask filters
- Time stamping
- DMA support in 16-bit PIC24H and PIC32 microcontrollers and dsPIC33F digital signal controllers
- DeviceNet™ support
- Legacy mode

Stand-alone CAN Controller

Microchip Technology's MCP2515 is a stand-alone Controller Area Network (CAN) controller that implements the CAN specification, version 2.0B. It is capable of transmitting and receiving both standard and extended data and remote frames. The MCP2515 interfaces with MCUs via an industry-standard Serial Peripheral Interface (SPI) and can be used as an easy method to implement CAN in an existing system.

CAN Transceivers

The MCP2561/2 are high-speed CAN transceivers that serve as an interface between a CAN controller and the physical bus. The MCP2561 is a SPLIT Option for common mode stabilization and the MCP2562 is a VIO Option for digital I/O level shifting from 1.8V to 5.5V. Both parts meet ISO and CAN specifications in addition to global automotive EMC hardware requirements.

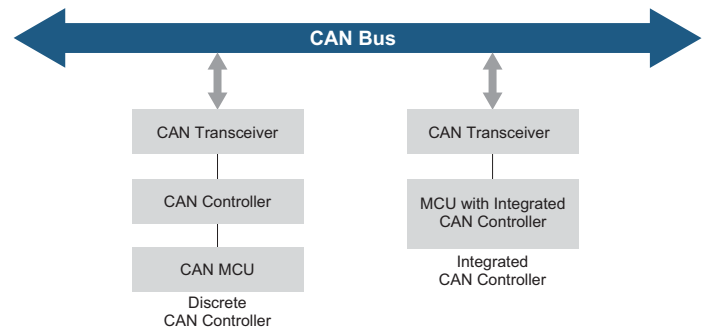

CAN Development Tools

CAN Bus Analyzer (APGDT002)



The CAN Bus Analyzer development tool enables a PC to communicate with the CAN bus. The PC program uses a graphical user interface to enter and display message frames occurring on the target bus, allowing for easy debugging. It can also be used as an active node on a bus to send and receive messages, reducing the application development time.

CAN/LIN PICTail Plus Daughter Board (AC164130-2)

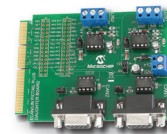

This daughter board can be used with the Explorer 16 Development Board and various PIMs featuring 16- and 32-bit MCUs with CAN peripherals, or the PIC18 Explorer Board with the PIC18F66K80 PIM to facilitate rapid implementation and evaluation of CAN and LIN applications.

PICDEM CAN-LIN 3 Demonstration Board (DM163015)

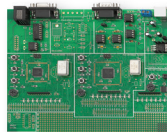

The PICDEM CAN-LIN 3 Demonstration Board provides an easy way to discover the power of Microchip's CAN and LIN products. The board demonstrates the main features of the 64-pin TQFP PIC18F6680 and 80-pin TQFP PIC18F8680 devices, including those features of the integrated CAN module. In addition, the board employs a LIN sub-network using Microchip's 20-pin SSOP PIC18F1320 and MCP201 LIN Bus.

Additional Connectivity Protocols

Providing Comprehensive System Solutions

Other Connectivity Options

While the most sophisticated protocols and interfaces tend to garner a significant amount of attention, a number of simpler connectivity options are and will remain the embedded interconnects of choice for designer of many deeply-embedded applications. Microchip's focus on the embedded market ensures an ongoing commitment to support all of the connectivity solutions utilized by leading designers including the microcontroller peripherals, application notes and software necessary to implement robust, highly-reliable embedded networks.

RS-485 Protocol

The RS-485 protocol is typically used as a more feature-rich alternative to RS-232. The protocol enables longer distance between nodes and higher data rates. Any PIC microcontroller with an on-board UART can support RS-485 communication. Many PIC microcontrollers include enhanced peripherals with an RS-485 mode.

IrDA® Protocol

The IrDA protocol provides many portable devices with an affordable, short distance optical data communications link. IrDA can be implemented on many Microchip MCUs using Microchip's free-of-charge IrDA software stack. In addition, Microchip offers UART to IrDA protocol converter products (MCP2140A, MCP2150) to enable any system to easily add IrDA wireless connectivity.

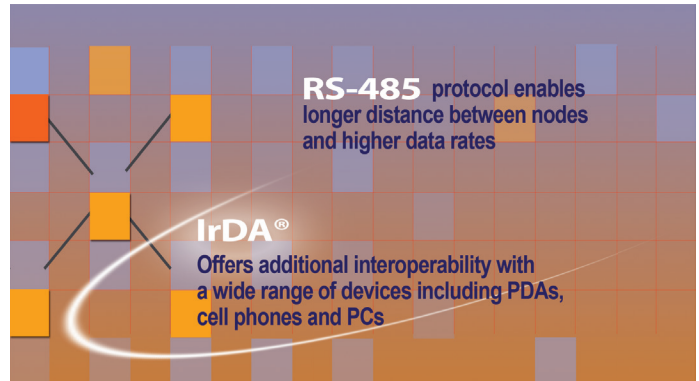

IrDA PICtail Plus Daughter Board (AC164124)



This daughter board enables IrDA connectivity when used with the Explorer 16 Development Board (DM240001).

MCP2140 Wireless Temperature Sensor Demonstration Board (MCP2140DM-TMPSNS)



This board demonstrates the communication of temperature data to a primary device (PDA or PC with IR port) via IrDA.

Machine-to-Machine (M2M) PICtail Daughter Board (AC320011)



The Machine-to-Machine (M2M) PICtail Daughter Board, which is based upon u-blox GPS and GSM/GPRS modules, makes it easy to create low-cost M2M applications with location awareness capabilities. The daughter board can be interfaced with Microchip's Multimedia Expansion Board and a PIC32 Starter Kit to provide you with a turnkey platform to get started with apps such as texting, email and GPS.

Support

Microchip is committed to supporting its customers in developing products faster and more efficiently. We maintain a worldwide network of field applications engineers and technical support ready to provide product and system assistance. In addition, the following service areas are available at www.microchip.com:

- **Support** link provides a way to get questions answered fast: <http://support.microchip.com>
- **Sample** link offers evaluation samples of any Microchip device: <http://sample.microchip.com>
- **Forum** link provides access to knowledge base and peer help: <http://forum.microchip.com>
- **Buy** link provides locations of Microchip Sales Channel Partners: www.microchip.com/sales

Sales Office Listing

AMERICAS

Atlanta
Tel: 678-957-9614

Austin
Tel: 512-257-3370

Boston
Tel: 774-760-0087

Chandler
Tel: 480-792-7200

Chicago
Tel: 630-285-0071

Cleveland
Tel: 216-447-0464

Dallas
Tel: 972-818-7423

Detroit
Tel: 248-538-2250

Houston
Tel: 281-894-5983

Indianapolis
Tel: 317-773-8323

Los Angeles
Tel: 949-462-9523

New York
Tel: 631-435-6000

San Jose
Tel: 408-735-9110

Toronto
Tel: 905-673-0699

EUROPE

Austria - Wels
Tel: 43-7242-2244-39

Denmark - Copenhagen
Tel: 45-4450-2828

France - Paris
Tel: 33-1-69-53-63-20

Germany - Dusseldorf
Tel: 49-2129-3766400

Germany - Munich
Tel: 49-89-627-144-0

Germany - Pforzheim
Tel: 49-7231-424750

Italy - Milan
Tel: 39-0331-742611

Italy - Venice
Tel: 39-049-7625286

Netherlands - Drunen
Tel: 31-416-690399

Poland - Warsaw
Tel: 48-22-3325737

Spain - Madrid
Tel: 34-91-708-08-90

Sweden - Stockholm
Tel: 46-8-5090-4654

UK - Wokingham
Tel: 44-118-921-5800

Training

If additional training interests you, then Microchip can help. We continue to expand our technical training options, offering a growing list of courses and in-depth curriculum locally, as well as significant online resources – whenever you want to use them.

- Technical Training Centers and Other Resources: www.microchip.com/training
- MASTERs Conferences: www.microchip.com/masters
- Worldwide Seminars: www.microchip.com/seminars
- eLearning: www.microchip.com/webseminars

ASIA/PACIFIC

Australia - Sydney
Tel: 61-2-9868-6733

China - Beijing
Tel: 86-10-8569-7000

China - Chengdu
Tel: 86-28-8665-5511

China - Chongqing
Tel: 86-23-8980-9588

China - Hangzhou
Tel: 86-571-87928115

China - Hong Kong SAR
Tel: 852-2943-5100

China - Nanjing
Tel: 86-25-8473-2460

China - Qingdao
Tel: 86-532-8502-7355

China - Shanghai
Tel: 86-21-5407-5533

China - Shenyang
Tel: 86-24-2334-2829

China - Shenzhen
Tel: 86-755-8864-2200

China - Wuhan
Tel: 86-27-5980-5300

China - Xiamen
Tel: 86-592-2388138

China - Xian
Tel: 86-29-8833-7252

China - Zhuhai
Tel: 86-756-3210040

ASIA/PACIFIC

India - Bangalore
Tel: 91-80-3090-4444

India - New Delhi
Tel: 91-11-4160-8631

India - Pune
Tel: 91-20-3019-1500

Japan - Osaka
Tel: 81-6-6152-7160

Japan - Tokyo
Tel: 81-3-6880-3770

Korea - Daegu
Tel: 82-53-744-4301

Korea - Seoul
Tel: 82-2-554-7200

Malaysia - Kuala Lumpur
Tel: 60-3-6201-9857

Malaysia - Penang
Tel: 60-4-227-8870

Philippines - Manila
Tel: 63-2-634-9065

Singapore
Tel: 65-6334-8870

Taiwan - Hsin Chu
Tel: 886-3-5778-366

Taiwan - Kaohsiung
Tel: 886-7-213-7830

Taiwan - Taipei
Tel: 886-2-2508-8600

Thailand - Bangkok
Tel: 66-2-694-1351

3/12/14

Microcontrollers • Digital Signal Controllers • Analog • Memory • Wireless

Information subject to change. The Microchip name and logo, the Microchip logo, dsPIC, MPLAB, mTouch, PIC and UNI/O are registered trademarks and MiWi, MultiTRAK, PICDEM, PICDEM.net, PICkit, PICtail, REAL ICE, VariSense and ZENA are trademarks of Microchip Technology Incorporated in the U.S.A. and other countries. All other trademarks mentioned herein are property of their respective companies. © 2014, Microchip Technology Incorporated. All Rights Reserved. Printed in the U.S.A. 6/14 DS00001181L

MICROCHIP
www.microchip.com

Microchip Technology Inc.
2355 W. Chandler Blvd.
Chandler, AZ 85224-6199