

Pressure Sensor of Stainless Steel Construction Is Ideal for a Wide Range of Applications

- Incorporates double diaphragms consisting of SUS316L stainless steel and silicone diaphragms that are applicable to a variety of gases and liquids.
- Two models with different pressure sensing ranges: 0 to 500 kPa and 0 to 1 MPa.
- Linear output from 4 to 20 mA with excellent linearity.
- IEC IP66 degree of protection: Washable with water.



 Be sure to read *Safety Precautions* on page 4.

Application Examples

- **Semiconductor Manufacturing Equipment:** Pressure monitoring and control
- **Automatic Assembly Equipment:** Pneumatic pressure control
- **Robots:** Pneumatic pressure control
- **Production Lines:** Pneumatic pressure control
- **Industrial Material Pneumatic Transportation Systems**
- **Pressure Tank:** Pressure control
- **Tank Level Control**

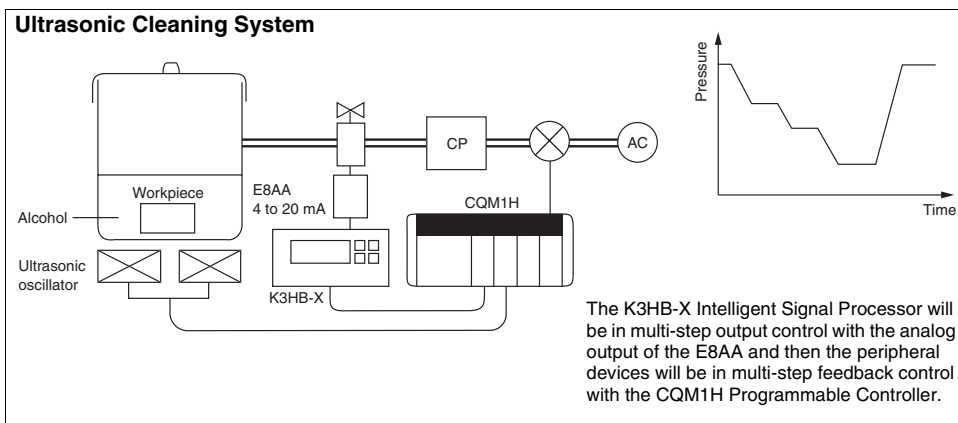

Ordering Information

Pressure range	Output configuration	Model
0 to 500 kPa	Linear output (4 to 20 mA)	E8AA-M05
0 to 1 MPa		E8AA-M10

Ratings and Specifications

Item	Model	E8AA-M05	E8AA-M10
Power supply voltage		12 to 24 VDC $\pm 10\%$, ripple (p-p): 5% max.	
Current consumption		40 mA max. (standard value including 20-mA output current) at rated pressure	
Pressure type		Gauge pressure	
Pressure range		0 to 500 kPa	0 to 1 MPa
Withstand pressure		980 kPa	2 MPa
Applicable material		Non-corrosive gasses, non-corrosive liquids, inert gasses	
Accuracy (linear output)		$\pm 1\%$ FS max. with a resistive load of 150 Ω at 23°C	
Hysteresis (linear output)		$\pm 0.5\%$ FS max.	
Linearity (linear output)		$\pm 1\%$ FS max.	
Response time		100 ms max.	
Linear output		4 to 20 mA with a permissible resistive load of 300 Ω max.	
Ambient temperature		Operating: -10°C to 60°C (with no icing) Storage: -25°C to 70°C (with no icing)	
Ambient humidity		Operating/Storage: 35% to 95% (with no condensation)	
Temperature influence		$\pm 0.09\%$ FS/ $^{\circ}\text{C}$ max. between -10°C and 60°C	
Voltage influence		Max. output current fluctuation of $\pm 0.5\%$ FS at 12 VDC $\pm 10\%$ or 24 VDC $\pm 10\%$ with a ripple of 5%	
Insulation resistance		100 M Ω min. (at 500 VDC) between current carry parts and case	
Dielectric strength		1,000 VAC, 1 min	
Vibration resistance		Destruction: 10 to 500 Hz, 1.5-mm double amplitude or 100 m/s ² for 2 hours each in X, Y, and Z directions	
Shock resistance		Destruction: 1,000 m/s ² 3 times each in X, Y, and Z directions.	
Degree of protection		IEC 60529 IP66 (excluding end of cable)	
Pressure inlet		R(PT)1/4	
Connection method		Pre-wired (standard cable length: 2 m)	
Weight (packed state)		Approx. 250 g	
Material	Pressure port and casing	SUS316	
	Diaphragm	SUS316L	
	O-ring	Fluorocarbon rubber	
Accessories		Protective cap, instruction manual	

Engineering Data (Typical)

Output Current Fluctuation vs. Temperature

E8AA-M10

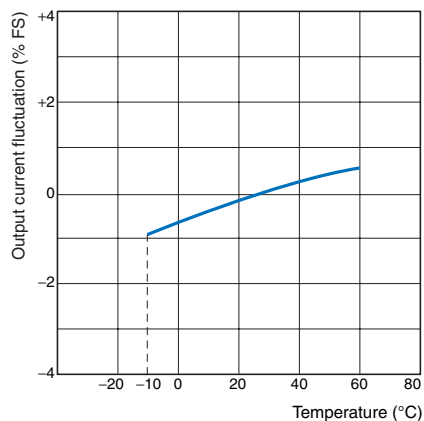

Linearity

E8AA-M05

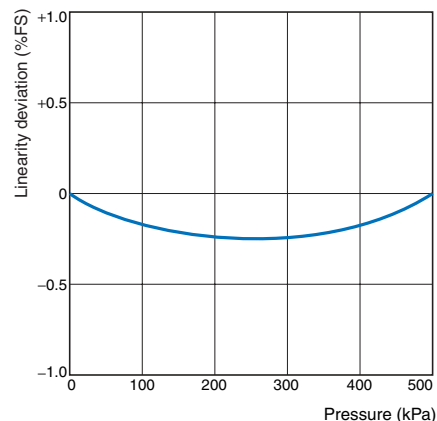

Output Current Fluctuation vs. Voltage

E8AA-M10

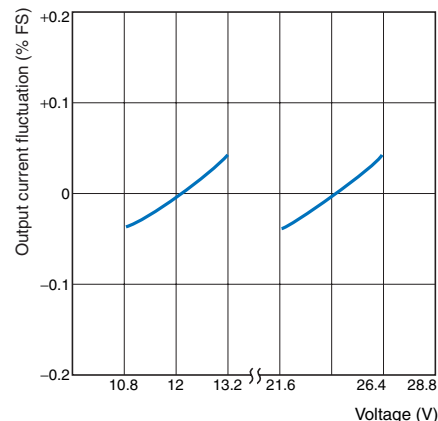

Output Current vs. Pressure

E8AA-M05 (E8AA-M10)

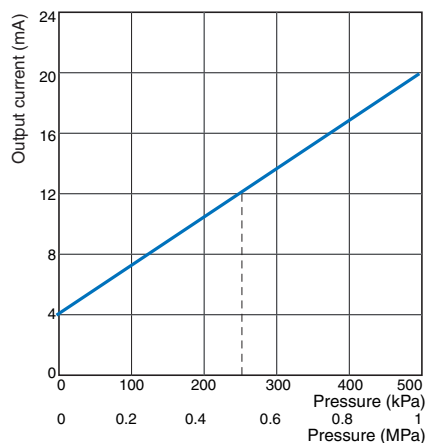

Output Current vs. Load

E8AA-M05

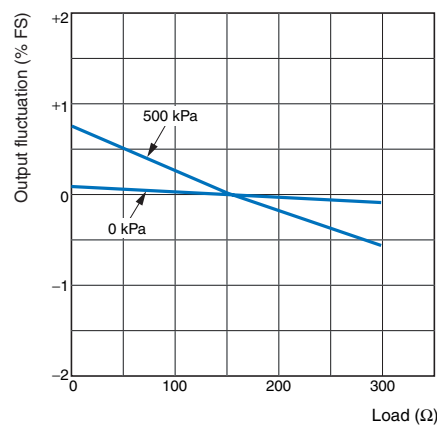

E8AA-M10

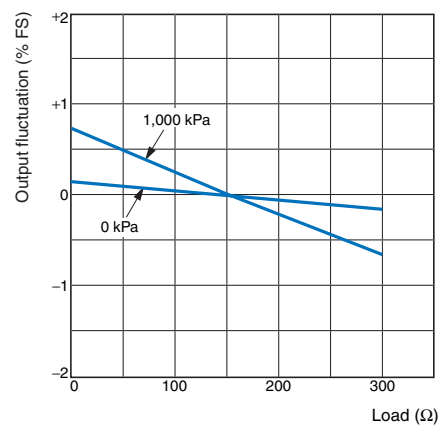

Nomenclature

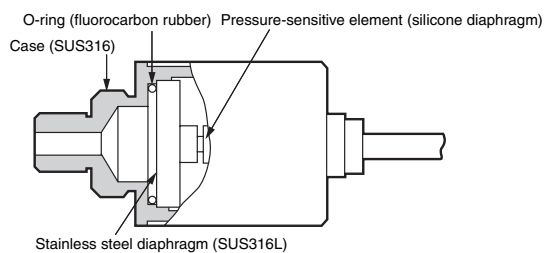

I/O Circuit Diagram

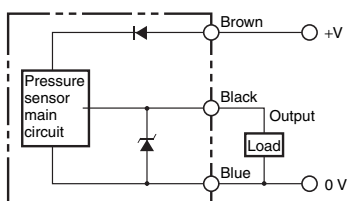

Safety Precautions

⚠ WARNING

This product is not designed or rated for ensuring safety of persons. Do not use it for such purposes.



Precautions for Correct Use

Do not use the product in atmospheres or environments that exceed product ratings.

Mounting

- The cable is in a hollow pipe in order to keep the pressure inside the Sensor the same as the atmospheric pressure. If the pipe is clogged, the accuracy of the Sensor may be lowered.
- Do not bend or impose a heavy weight on the output cable.
- Make sure that the tip of the output cable is open and not clogged with dust or water.
- If the diaphragms are damaged, the Unit will not operate properly. Do not insert a screwdriver or steel wire into the interior of the pressure-sensitive parts.
- The characteristics of the Unit will change if foreign material is stuck to the stainless steel diaphragm.

- The mounting screw for the pressure inlet is a PT1/4 taper screw. Do not use any other type of screw.
- Apply sealing tape to the PT1/4 screw part so that there will be no pressure leakage.
- The most suitable wrench is 22 mm in size.
- Do not apply a tightening torque higher than 49 N·m.
- Do not use the E8AA for applications in which the E8AA comes into direct contact with medical or food products.

Wiring

- If it is necessary to cut the output cable, make sure that the tip of the hollow pipe is not clogged.

Dimensions

(Unit: mm)

E8AA-M05
E8AA-M10

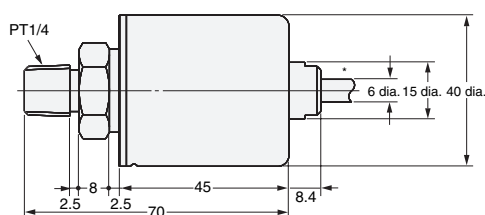
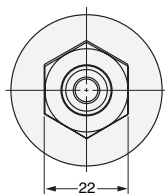
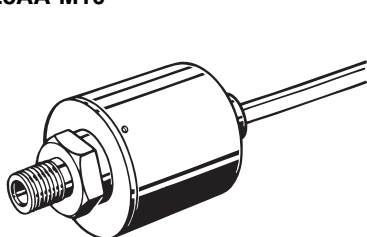

* 6-dia. vinyl-insulated round cable (in hollow pipe) with 3 conductors,
(Conductor cross-section: 0.3 mm², Insulator diameter: 1.5 mm); Standard length: 2 m

In the interest of product improvement, specifications are subject to change without notice.

Read and Understand This Catalog

Please read and understand this catalog before purchasing the products. Please consult your OMRON representative if you have any questions or comments.

Warranty and Limitations of Liability

WARRANTY

OMRON's exclusive warranty is that the products are free from defects in materials and workmanship for a period of one year (or other period if specified) from date of sale by OMRON.

OMRON MAKES NO WARRANTY OR REPRESENTATION, EXPRESS OR IMPLIED, REGARDING NON-INFRINGEMENT, MERCHANTABILITY, OR FITNESS FOR PARTICULAR PURPOSE OF THE PRODUCTS. ANY BUYER OR USER ACKNOWLEDGES THAT THE BUYER OR USER ALONE HAS DETERMINED THAT THE PRODUCTS WILL SUITABLY MEET THE REQUIREMENTS OF THEIR INTENDED USE. OMRON DISCLAIMS ALL OTHER WARRANTIES, EXPRESS OR IMPLIED.

LIMITATIONS OF LIABILITY

OMRON SHALL NOT BE RESPONSIBLE FOR SPECIAL, INDIRECT, OR CONSEQUENTIAL DAMAGES, LOSS OF PROFITS OR COMMERCIAL LOSS IN ANY WAY CONNECTED WITH THE PRODUCTS, WHETHER SUCH CLAIM IS BASED ON CONTRACT, WARRANTY, NEGLIGENCE, OR STRICT LIABILITY.

In no event shall the responsibility of OMRON for any act exceed the individual price of the product on which liability is asserted.

IN NO EVENT SHALL OMRON BE RESPONSIBLE FOR WARRANTY, REPAIR, OR OTHER CLAIMS REGARDING THE PRODUCTS UNLESS OMRON'S ANALYSIS CONFIRMS THAT THE PRODUCTS WERE PROPERLY HANDLED, STORED, INSTALLED, AND MAINTAINED AND NOT SUBJECT TO CONTAMINATION, ABUSE, MISUSE, OR INAPPROPRIATE MODIFICATION OR REPAIR.

Application Considerations

SUITABILITY FOR USE

OMRON shall not be responsible for conformity with any standards, codes, or regulations that apply to the combination of products in the customer's application or use of the products.

At the customer's request, OMRON will provide applicable third party certification documents identifying ratings and limitations of use that apply to the products. This information by itself is not sufficient for a complete determination of the suitability of the products in combination with the end product, machine, system, or other application or use.

The following are some examples of applications for which particular attention must be given. This is not intended to be an exhaustive list of all possible uses of the products, nor is it intended to imply that the uses listed may be suitable for the products:

- Outdoor use, uses involving potential chemical contamination or electrical interference, or conditions or uses not described in this catalog.
- Nuclear energy control systems, combustion systems, railroad systems, aviation systems, medical equipment, amusement machines, vehicles, safety equipment, and installations subject to separate industry or government regulations.
- Systems, machines, and equipment that could present a risk to life or property.

Please know and observe all prohibitions of use applicable to the products.

NEVER USE THE PRODUCTS FOR AN APPLICATION INVOLVING SERIOUS RISK TO LIFE OR PROPERTY WITHOUT ENSURING THAT THE SYSTEM AS A WHOLE HAS BEEN DESIGNED TO ADDRESS THE RISKS, AND THAT THE OMRON PRODUCTS ARE PROPERLY RATED AND INSTALLED FOR THE INTENDED USE WITHIN THE OVERALL EQUIPMENT OR SYSTEM.

PROGRAMMABLE PRODUCTS

OMRON shall not be responsible for the user's programming of a programmable product, or any consequence thereof.

Disclaimers

CHANGE IN SPECIFICATIONS

Product specifications and accessories may be changed at any time based on improvements and other reasons.

It is our practice to change model numbers when published ratings or features are changed, or when significant construction changes are made. However, some specifications of the products may be changed without any notice. When in doubt, special model numbers may be assigned to fix or establish key specifications for your application on your request. Please consult with your OMRON representative at any time to confirm actual specifications of purchased products.

DIMENSIONS AND WEIGHTS

Dimensions and weights are nominal and are not to be used for manufacturing purposes, even when tolerances are shown.

PERFORMANCE DATA

Performance data given in this catalog is provided as a guide for the user in determining suitability and does not constitute a warranty. It may represent the result of OMRON's test conditions, and the users must correlate it to actual application requirements. Actual performance is subject to the OMRON Warranty and Limitations of Liability.

ERRORS AND OMISSIONS

The information in this document has been carefully checked and is believed to be accurate; however, no responsibility is assumed for clerical, typographical, or proofreading errors, or omissions.

2009.10

In the interest of product improvement, specifications are subject to change without notice.

OMRON Corporation
Industrial Automation Company

<http://www.ia.omron.com/>

(c)Copyright OMRON Corporation 2009 All Right Reserved.