

Development Kit

MLX91206

REV002 – 2011

1 Description

The development kit provides the needed information and components to develop a current sensor based on the MLX91206. The main goal is to show the functionalities and the features of the part in a simple and effective way.

The kit includes:

- 1 MLX91206CAL mounted on PCB_EC01
- 1 MLX91206CAL mounted on PCB_EC02
- 1 separate MLX91206CAL
- 3 separate MLX91206CAHs
- 1 separate PCB_EC01
- 1 separate PCB_EC02
- 2 shields U_12

The kit does not include a bus bar.

Datasheet and Application Note can be found on www.melexis.com

2 Specification of EC-01

The included PCB utilizes PCB traces for medium current range measurements.

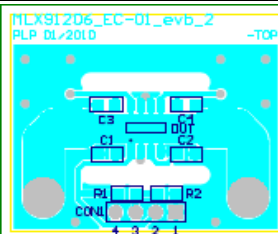
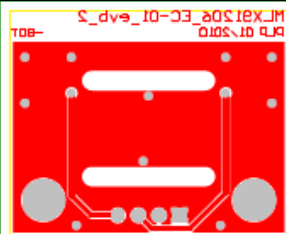
Layer:	Two layer with copper thickness 105µm The top layer is a conductor The bottom layer is an expanded ground layer	
	TOP- layer	Bottom- layer
		
Current:	We recommend ⁽¹⁾ : MAX 30A RMS for PCB application MAX 1kA for Bus bar application	
Dimension [l/b/h]:	36.8mm x 30.5mm x 1.6mm	

(1): The maximum current is limited by the PCB. For higher currents (> 30A), one can use an external conductor (i.e. a bus bar).

3 Specification of EC-02

The included PCB is based on PCB loops for small current range measurements.

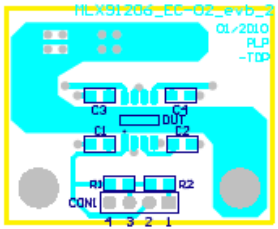
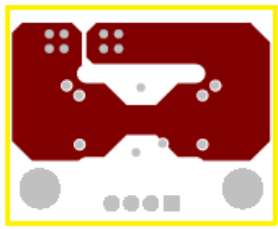
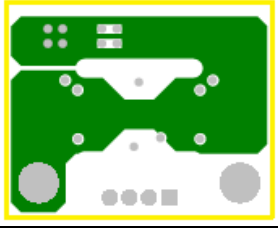
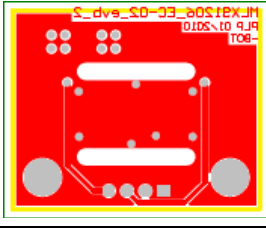
Layer:	Four layers, Top- and Bottom- layer with copper thickness 105µm, Second- and the Third- layer with copper thickness 35µm Three loops are on the PCB	
	Top- layer	Second- layer
		
	Third - layer	Bottom- layer
		
Current:	We recommend ⁽¹⁾ : MAX 30A RMS for PCB application MAX 1kA for Bus bar application	
Dimension [l/b/h]:	36.8mm x 30.5mm x 2mm	

(1): The maximum current is limited by the PCB. For higher currents (> 30A), one can use an external conductor (i.e. a bus bar).

4 Details about the “multi-turn” concept

The purpose of the EC-02 and EC-03 PCBs is to offer a “coil-like” design, which acts as 3 windings (or 6 in the EC-03 case), in order to increase the sensitivity of the sensor. The PCB consists in 3 layers: top, second and third. This design allows the current flowing 3 times (6 times with the EC-03) below the sensor, increasing the field (and the sensitivity) as with a coil.

5 Sensor sensitivity

Product Code	Ordering Option Code	Sensitivity Range (Typ.)
MLX91206	CAL-001	460-700mV/mT (580mV/mT)
MLX91206	CAL-002	300-470mV/mT (380mV/mT)
MLX91206	CAL-003	200-310mV/mT (250mV/mT)
MLX91206	CAH-001	210-330mV/mT (270mV/mT)
MLX91206	CAH-002	130-220mV/mT (170mV/mT)
MLX91206	CAH-003	80-140mV/mT (110mV/mT)
MLX91206	CAH-004	60-110mV/mT (77.5mV/mT)

6 Schematic

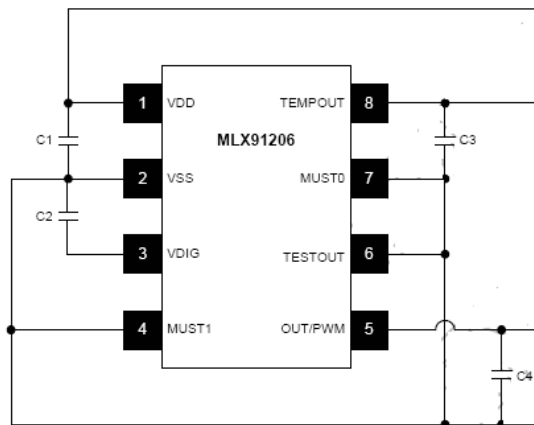

DUT:	MLX91206
C1:	100 nF
C2:	100 nF
C3:	10 nF
C4:	10 nF

VDD:	pos. supply voltage
VSS:	supply common
OUT/PWM:	analog sensor output
TEMPOUT:	temperature output

CON1 on the PCB EC-01 and EC-02:

Pin #	Connected to
1	GND/VSS
2	VDD
3	OUT/PWM
4	TEMPOUT

7 U_12 shield description

The shield is made of soft ferromagnetic material (i.e. low cost Fe-Si or Ni-Fe alloys) with a high μ value, this attracts and concentrates the magnetic flux. In order to get a low hysteresis the shields are annealed after shaping. Any applied mechanical stress will deteriorate the performance and should be avoided. The purpose of the shield is to concentrate the wanted signal and to reduce the influence of stray fields. Our shield is usable for both bus bar and PCB applications.

7.1 Geometry

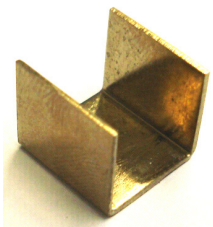
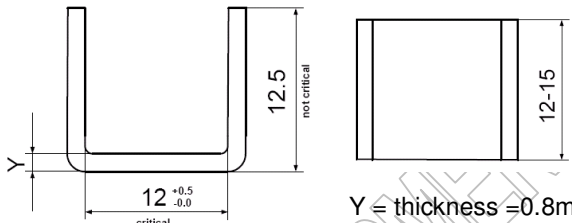
View	Dimension [mm]
	 <p>Y = thickness = 0.8mm</p>

- Material: Mu - Metal with 48%Ni
- Shielding factor is > 50 in the linear range
- Nonlinearity is < 0.05mT in the linear range
- The onset of the saturation starts at about ± 25 mT
- Weight: 3.14g

7.2 Good to know about shield

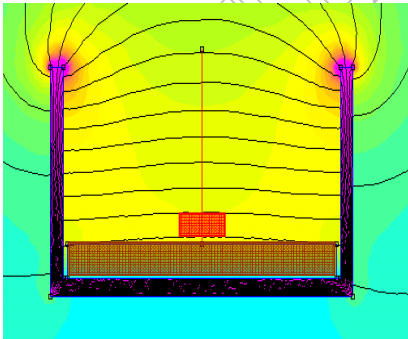
Simulation	Recommendation
	<ul style="list-style-type: none"> • The closer the sensor to the ground plate of the shield, the better the shielding against external stray fields → try to position the sensor as close as possible to the ground plate of the shield • The higher and longer the shield the better the shielding → choose the right dimension for your application • The closer the sensor to the bus bar the better is the signal to noise ratio → try to position the sensor as close as possible to the bus bar

8 Typical output

8.1 Typical output with PCB_EC-01

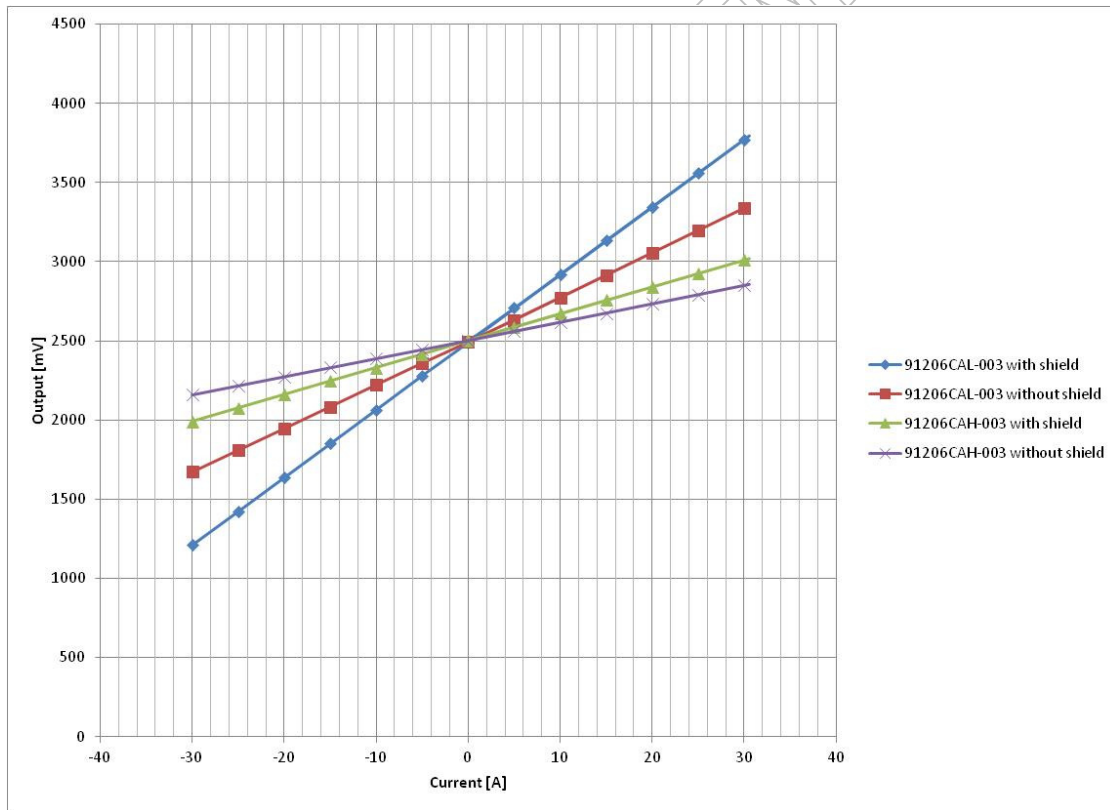
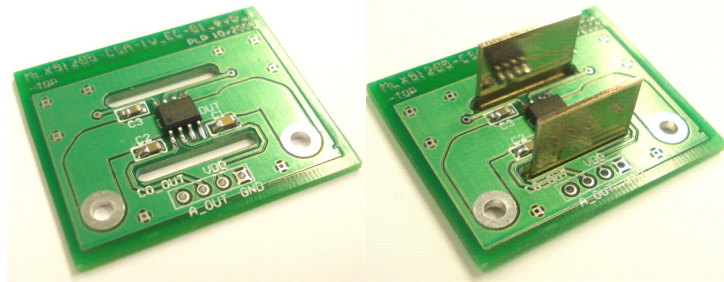

	without shield		with shield	
	91206CAH-003	91206CAL-003	91206CAH-003	91206CAL-003
Sensitivity [mV/A]:	12.7	28	18.7	42.5
Current range [A]:	+/-200	+/-70	+/-135	+/-50

8.2 Typical output with PCB_EC-02

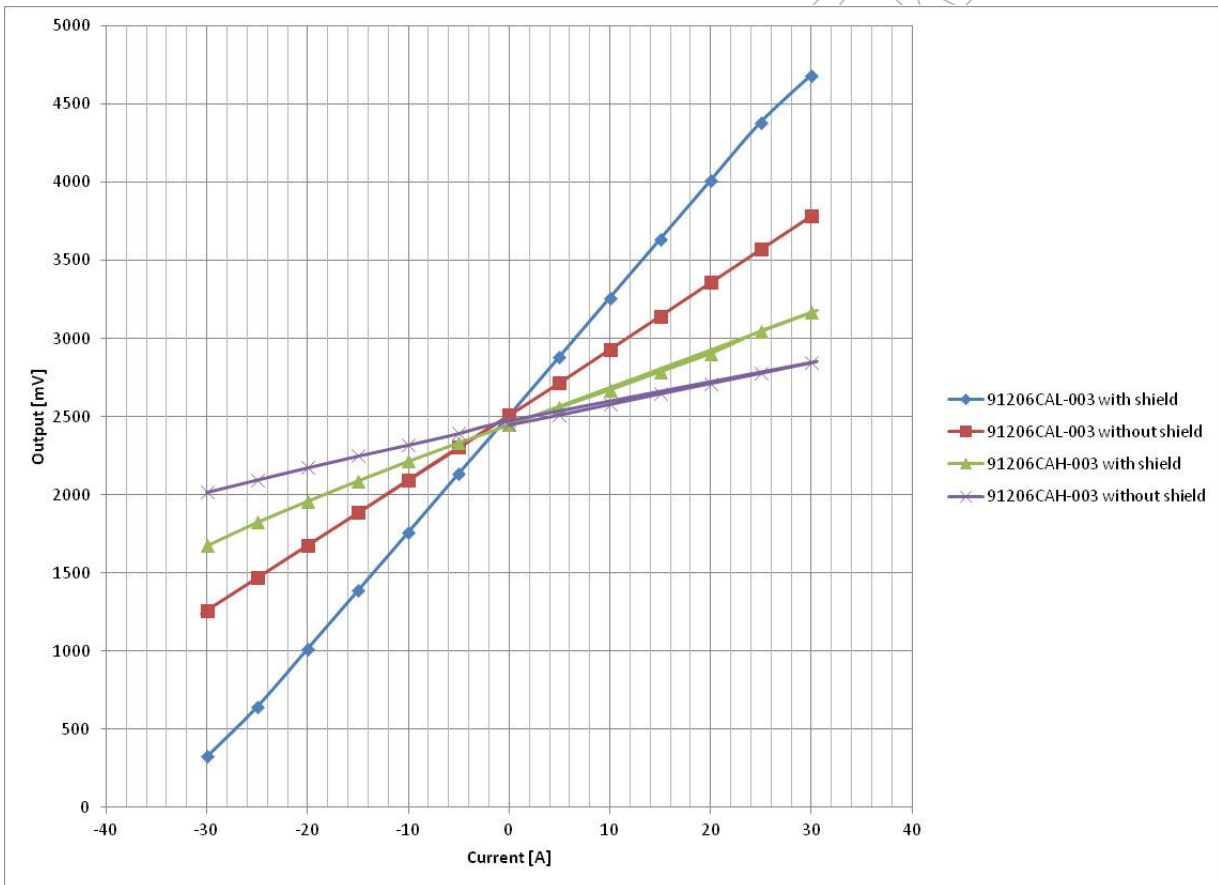
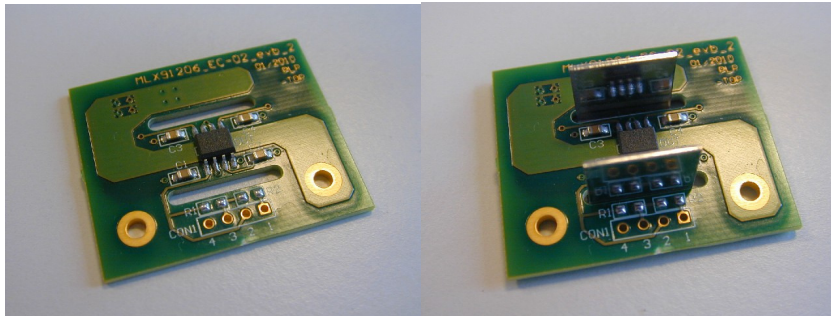

	without shield		with shield	
	91206CAH-003	91206CAL-003	91206CAH-003	91206CAL-003
Sensitivity [mV/A]:	27.5	62	40.7	92.5
Current range [A]:	+/-90	+/-30	+/-50	+/-18

8.3 Typical output with bus bar

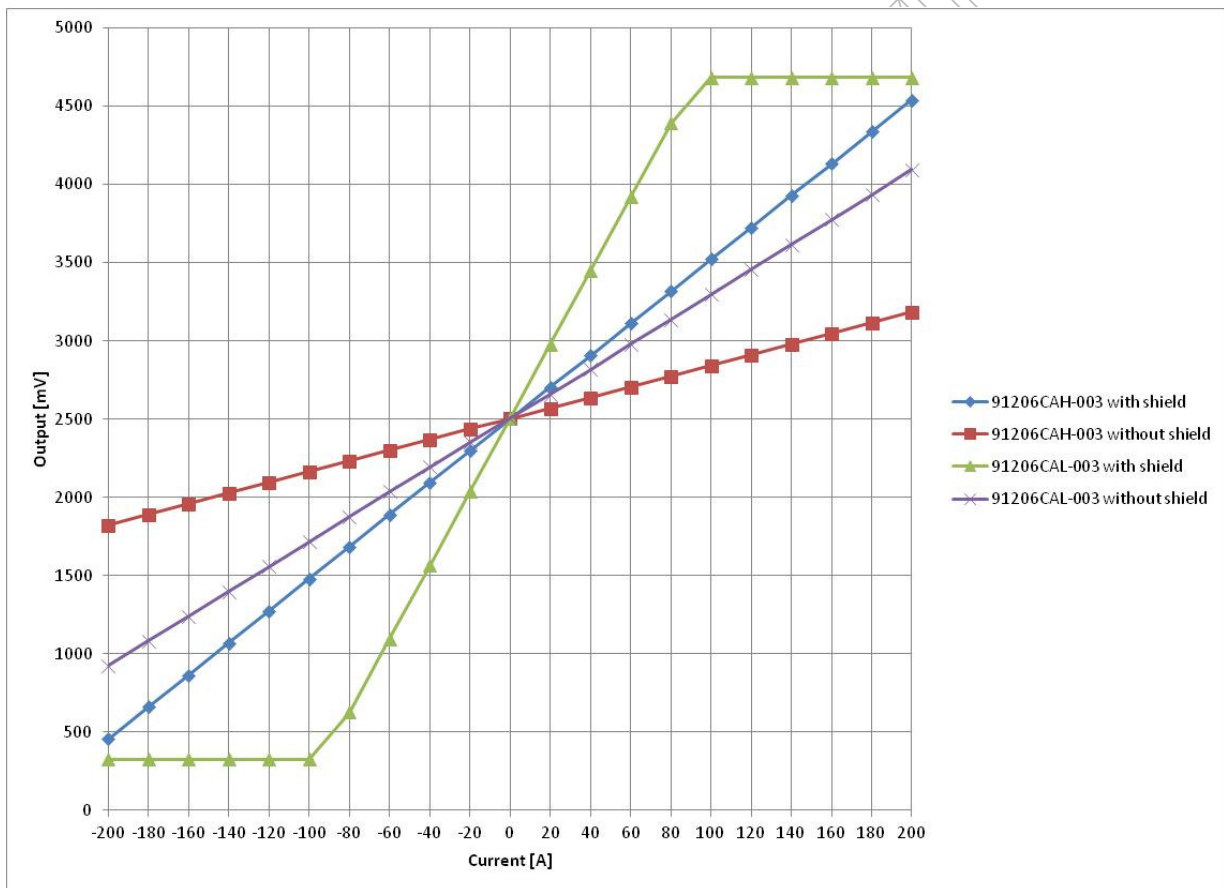
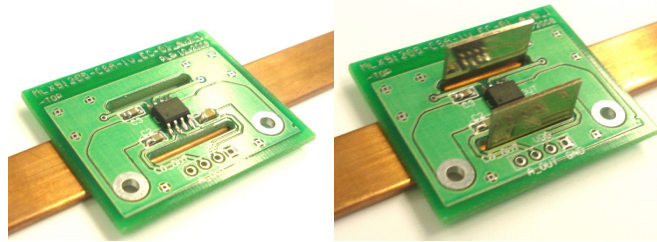

	without shield		with shield	
	91206CAH-003	91206CAL-003	91206CAH-003	91206CAL-003
Sensitivity [mV/A]:	3.6	8	12.2	24
Current range [A]:	+/-600	+/-240	+/-250	+/-100

- The dimension of the used copper bus bar was 12mm x 100mm x 2mm.

9 Possible programming

9.1 OFFSET vs. XA parameter

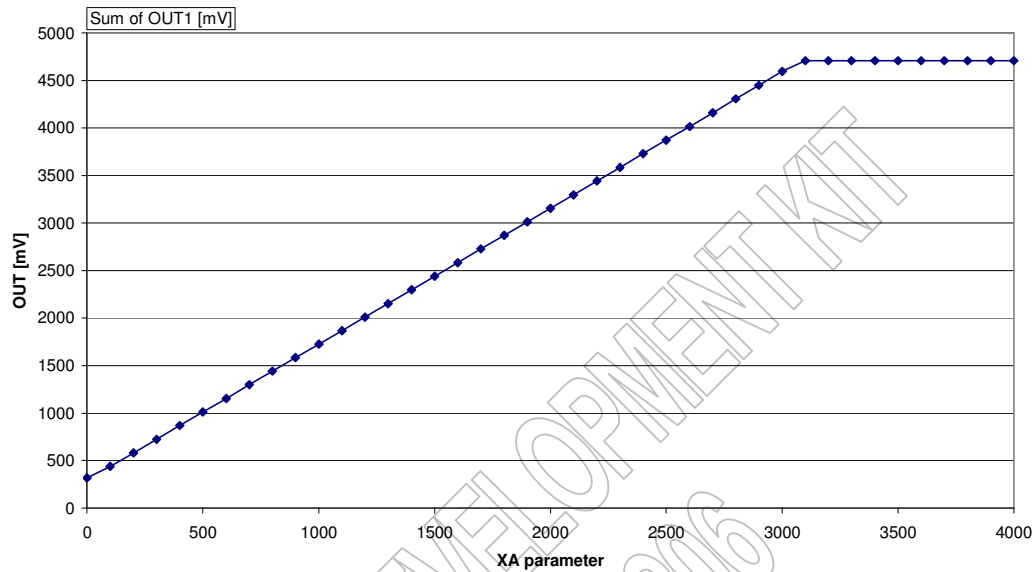

- Possible to set the offset voltage between 300 and 4700 mV

9.2 OUT vs. CURRENT with different ROUGHGAIN and FINEGAIN

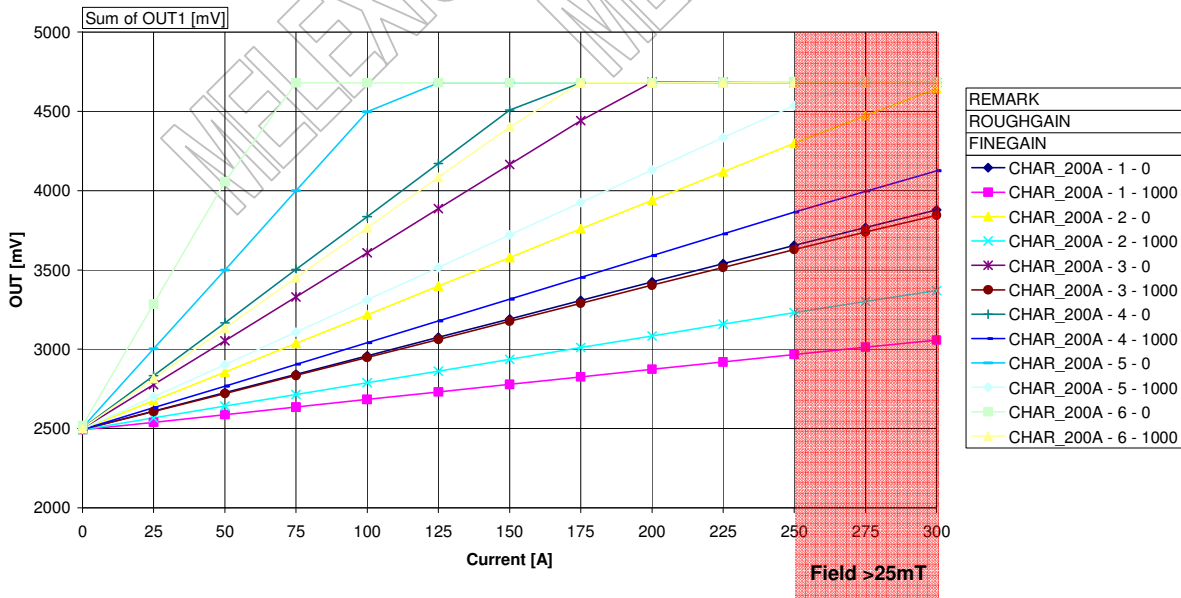

- Measurements based on bus bar 12mm x 100mm x 2mm
- Demonstrators can be build for ranges from $\pm 50A$ to $\pm 250A$

9.3 Sensitivity vs. ROUGHGAIN with different FINEGAIN

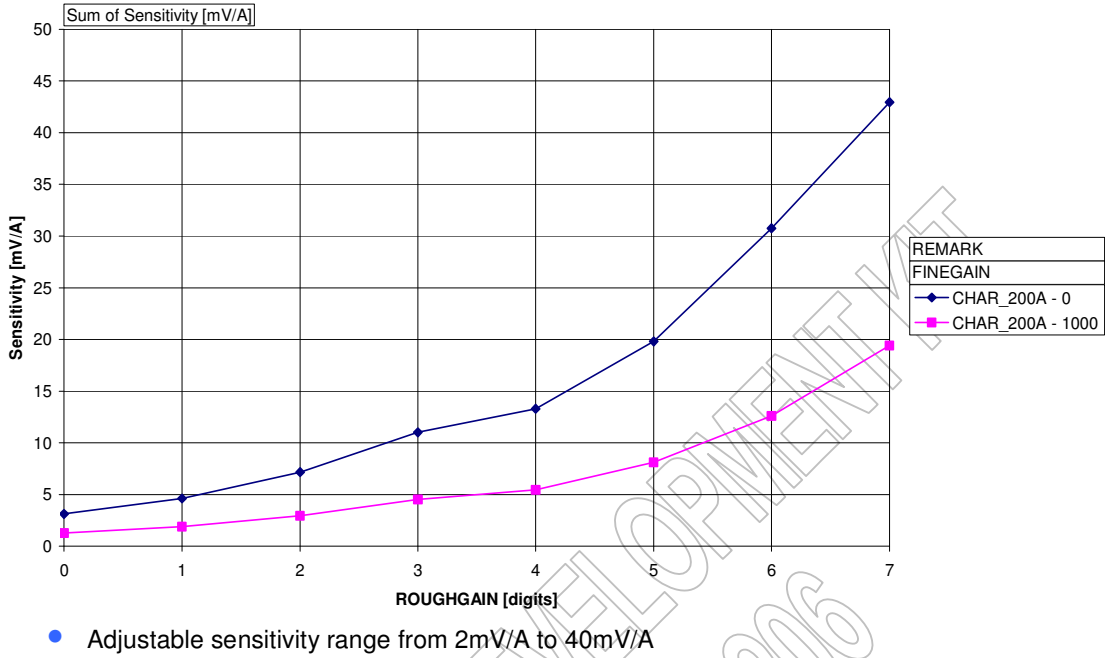

Examples of possible demonstrators with MLX91206:

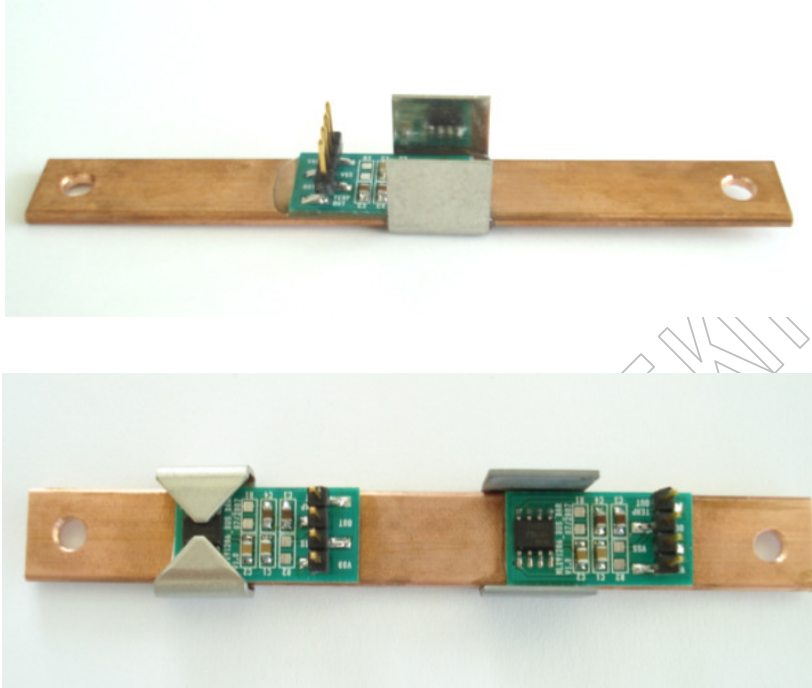

Melexis will be happy to support you design-in. Please feel free to contact us for further questions.

Sebastien Grisot
Application Engineer
sgt@melexis.com