

ASSEMBLY

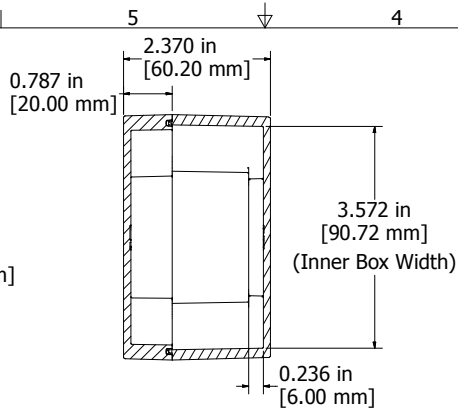

SECTION A-A
End View of Assembly

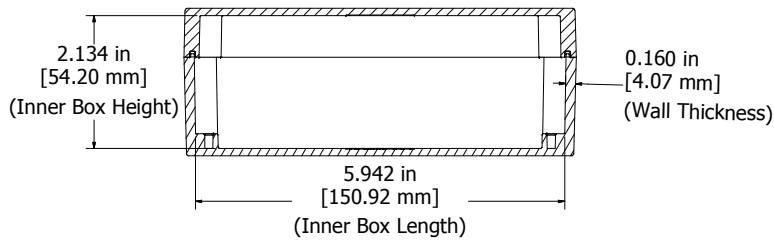

SECTION B-B
Side View of Assembly

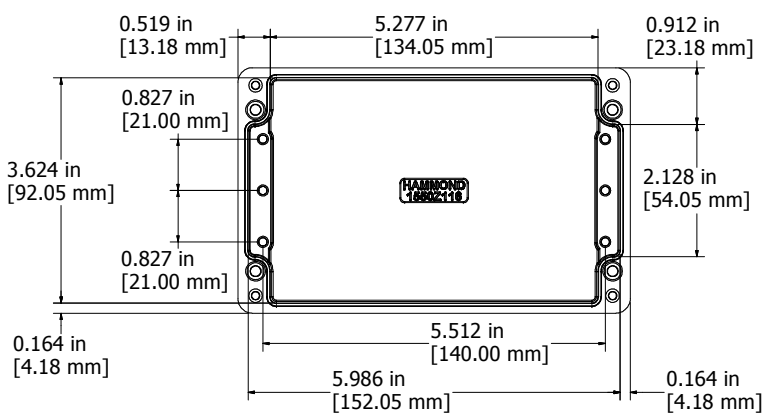
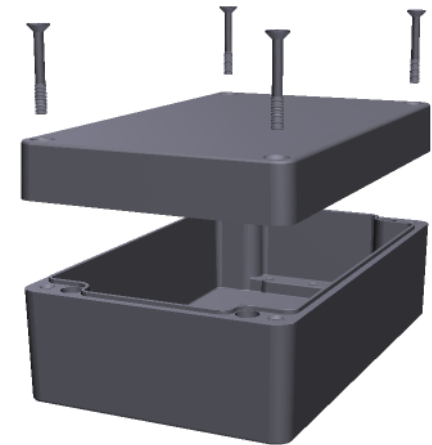

Top View Looking Inside Box

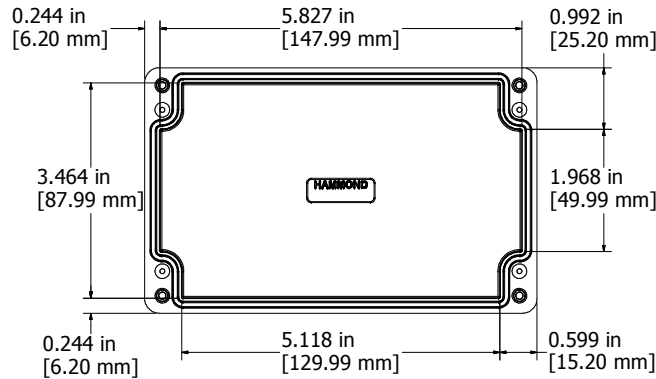

View Looking Inside Lid

Enclosures can be Factory Modified (Milling, Drilling, Printing etc.)
 Contact Factory mjm@hammondmfg.com for quotes
 Solid models of this enclosure available in STEP or IGES.

NOTES	
Purchased assembly includes enclosure, M4x30 lid screws	
Gasket - Pre-formed Silicone Rubber	
Cover screws should be torqued to 5-7.5 lbf.in (50-75 cN.m)	

1550Z116	
PART NUMBERS	
Unfinished	1550Z116
Black Textured Powder Paint - RAL 9011	1550Z116BK

