



**PY-1A**  
**AC / DC Voltage Tester**

**Users Manual**

- Mode d'emploi
- Bedienungshandbuch
- Manual d'Uso
- Manual de uso

## **Limited Warranty and Limitation of Liability**

Your Amprobe product will be free from defects in material and workmanship for 1 year from the date of purchase. This warranty does not cover fuses, disposable batteries or damage from accident, neglect, misuse, alteration, contamination, or abnormal conditions of operation or handling. Resellers are not authorized to extend any other warranty on Amprobe's behalf. To obtain service during the warranty period, return the product with proof of purchase to an authorized Amprobe Test Tools Service Center or to an Amprobe dealer or distributor. See Repair Section for details. THIS WARRANTY IS YOUR ONLY REMEDY. ALL OTHER WARRANTIES - WHETHER EXPRESS, IMPLIED OR STATUTORY - INCLUDING IMPLIED WARRANTIES OF FITNESS FOR A PARTICULAR PURPOSE OR MERCHANTABILITY, ARE HEREBY DISCLAIMED. MANUFACTURER SHALL NOT BE LIABLE FOR ANY SPECIAL, INDIRECT, INCIDENTAL OR CONSEQUENTIAL DAMAGES OR LOSSES, ARISING FROM ANY CAUSE OR THEORY. Since some states or countries do not allow the exclusion or limitation of an implied warranty or of incidental or consequential damages, this limitation of liability may not apply to you.

## **Repair**

All test tools returned for warranty or non-warranty repair or for calibration should be accompanied by the following: your name, company's name, address, telephone number, and proof of purchase. Additionally, please include a brief description of the problem or the service requested and include the test leads with the meter. Non-warranty repair or replacement charges should be remitted in the form of a check, a money order, credit card with expiration date, or a purchase order made payable to Amprobe® Test Tools.

## **In-Warranty Repairs and Replacement – All Countries**

Please read the warranty statement and check your battery before requesting repair. During the warranty period any defective test tool can be returned to your Amprobe® Test Tools distributor for an exchange for the same or like product. Please check the "Where to Buy" section on [www.amprobe.com](http://www.amprobe.com) for a list of distributors near you. Additionally, in the United States and Canada In-Warranty repair and replacement units can also be sent to a Amprobe® Test Tools Service Center (see next page for address).

### **Non-Warranty Repairs and Replacement – US and Canada**

Non-warranty repairs in the United States and Canada should be sent to a Amprobe® Test Tools Service Center. Call Amprobe® Test Tools or inquire at your point of purchase for current repair and replacement rates.

In USA

Amprobe Test Tools

Everett, WA 98203

Tel: 888-993-5853

Fax: 425-446-6390

In Canada

Amprobe Test Tools

Mississauga, ON L4Z 1X9

Tel: 905-890-7600

Fax: 905-890-6866

### **Non-Warranty Repairs and Replacement – Europe**

European non-warranty units can be replaced by your Amprobe® Test Tools distributor for a nominal charge. Please check the "Where to Buy" section on [www.amprobe.com](http://www.amprobe.com) for a list of distributors near you.

Amprobe® Test Tools Europe

In den Engematten 14

79286 Glottertal, Germany

tel: +49 (0) 7684 8009 - 0

\*(Correspondence only – no repair or replacement available from this address. European customers please contact your distributor.)

## PY-1A AC / DC Voltage Tester

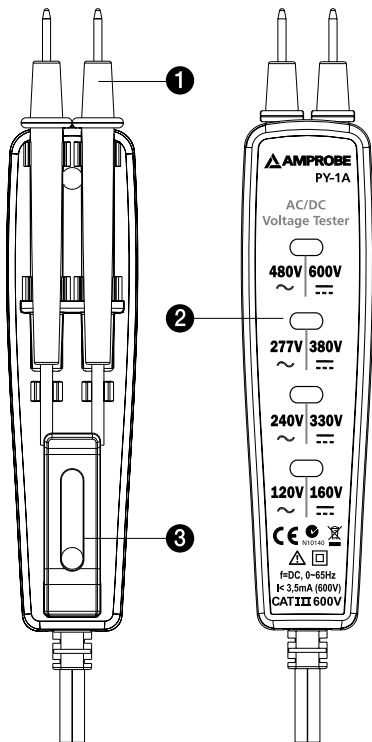







- 1 Test Probes
- 2 Neon for Voltage indication
- 3 Pocket Clip

---

## CONTENTS

|                                |   |
|--------------------------------|---|
| SYMBOLS .....                  | 2 |
| UNPACKING AND INSPECTION ..... | 5 |
| INTRODUCTION .....             | 5 |
| OPERATION .....                | 5 |
| SPECIFICATION .....            | 6 |
| MAINTENANCE .....              | 6 |
| TROUBLE SHOOTING.....          | 7 |

## SYMBOLS

|   |   |
|---|---|
|  | Warning of a potential danger, comply with instruction manual.  |
|  | Caution! Dangerous Voltage. Danger of electrical shock.   |
|  | Continuous double or reinforced insulation complies with Category II IEC 536  |
|  | Conformity symbol, the instrument complies with the valid directives. It complies with the EMC Directive (89/336/EEC), Standards EN 50081 and EN 50082-1 are fulfilled. It also complies with the low Voltage Directive (73/23/EEC), Standard EN 61010-1 is fulfilled. Measurement category III is for measurements performed in the building installation. |
|  | Instrument complies with the standard (2002/96/EEC) WEEE  |
|  | The instruction manual contains information and references, necessary for safe operation and maintenance of the instrument.   |

### **Warnings!**

This Electrical Tester has been constructed and verified in compliance with the latest safety standards and have left the factory in safe and perfect conditions. Prior to using the instrument (commissioning/assembly) the user is kindly requested to thoroughly read the instruction manual and comply with it in all sections.

- Failure to read the instruction manual or to comply with the warnings and references contained herein can result in serious bodily injury or instrument damage.

- The respective accident prevention regulations established by the professional associations for electrical system and equipment must be strictly met at all times.
- In order to avoid electrical shock, the valid safety regarding excessive contact voltages must receive utmost attention, when working with voltages exceeding 120V (60V) DC or 50V (25V) rms AC. The values in bracket are valid for limited ranges (as for example medicine and agriculture).
- Never connect the tester to voltage for longer than 30 seconds. For next operation, a recovery time of minimum 240 seconds is needed
- The instrument may only be used within the operating ranges as specified in the technical data section and in low voltage system up to 600V.
- Measurements in dangerous proximity of electrical system are only to be carried out in compliance with the instructions of a responsible electronics technician, and never alone.
- The electrical testers may no longer be used if one or several functions fail or if no functionality is indicated.
- Do not use this instrument under damp conditions.
- Perfect display is only guaranteed within a temperature range of 5°C up to +40°C at relative humidity <80%.
- Test leads and test probes may only be touched at handle surfaces provided. Absolutely avoid the direct contact of the rest probes.
- Prior to usage ensure perfect instrument function (e.g. on known voltage source).
- The instrument may only be opened by an authorized service technician.

## **The safety can no longer be insured if the instrument:**

- Shows obvious damage.
- Does not carry out the desired measurements.
- Has been stored for too long under unfavorable conditions
- Has been subjected to mechanical stress during transport.
- Avoid any heating up of the instrument by direct sunlight to ensure perfect functioning and long instrument life.
- The instrument may only be used under those conditions and for those purposes for which it was conceived. For this reason, in particular the safety references, the technical data including environmental conditions and the usage in dry environments must be followed. When modifying or changing the instrument, the operational safety is no longer ensured.
- The instrument may only be used under those conditions and for which it was conceived. For this reason, in particular the safety references, the technical data including the environmental conditions and the usage in dry environments must be followed.

## **UNPACKING AND INSPECTION**

---

Your shipping carton should include:

- 1 Electrical Tester PY-1A
- 1 Instruction Manual

If any of the items are damaged or missing, return the complete package to the place of purchase for an exchange.



## INTRODUCTION

---

This Electrical Tester is for universal applications for indoor use only. It represents a valuable support for all testing in handicraft and industrial applications.

The electrical tester is characterized by the following features.

- AC voltage detection up to 480V, and DC voltage upto 600V.
- Bright neon AC/DC voltage display.
- Ergonomically and robust housing.
- Snap-in leads are spaced to fit to the standard US/ Canada outlet, for easy, one hand operation.
- Integral probe storage for easy carrying.

## OPERATION

---

- Test the electrical tester on a known source.
- Connect both test leads with UUT.
- The voltage is displayed via Neon lamps.
- The instrument with 120, 240, 277, 480V AC range and 160, 330, 380, 600V DC range.

## SPECIFICATION

---

|                            |  |
|----------------------------|--|
| <b>Voltage Range</b>       | 120, 240, 277, 480V AC<br>160, 330, 380, 600V DC |
| <b>Response Time</b>       | <0,3s  |
| <b>Frequency Range</b>     | DC, 0~65Hz                                       |
| <b>Interal Load</b>        | approx. 2.0 W/ 600V                              |
| <b>Test Current</b>        | <3.5 mA  |
| <b>Operation Time (DT)</b> | 30s  |
| <b>Recovery Time</b>       | 240s   |
| <b>Temperature Range</b>   | 5°C ~ +40°C (41°F ~ 104°F)                       |

|   |                          |
|---|--------------------------|
| <b>Humidity</b>                           | Max. 80% rel. H.         |
| <b>Height above sea level</b>             | up to 2000 m (6562 ft)   |
| <b>Measurement Cat.</b>                   | CATIII / 600V            |
| <b>Pollution Degree</b>                   | 2                        |
| <b>Safety Standards</b><br>22.2 No. 61010 | IEC 61010, UL 61010, CSA |
| <b>Weight</b>                             | Approx. 50g (0.11 lb)    |
| <b>Dimension</b><br>(5.9x1.3x1.0 in)      | Approx. 150X32X26 mm     |

## **MAINTENACE**

---

When using the instrument in compliance with the instruction manual, no special maintenance is required. Should operational problems occur during daily use, our consulting service will be at your disposal, free of charge.

If functional errors occur after expiration of warranty, the repairing of the tester should be performed only by a Factory Authorized Service Center or by other qualified instrument service personnel. The front panel and case can be cleaned with a mild solution of detergent and water. Apply sparingly with a soft cloth and allow to dry completely before using. Do not use aromatic hydrocarbons or chlorinated solvents for cleaning.

Do not attempt to repair this tester. It contains no user-serviceable parts. Repair or servicing should only be performed by qualified personnel.

## **TROUBLE SHOOTING**

---

If the instrument fails to operate, check test leads, and replace as necessary. Double check operating procedure as described in this user's manual.



**Visit [www.Amprobe.com](http://www.Amprobe.com) for**

- Catalog
- Application notes
- Product specifications
- User manuals



Please Recycle