

DESCRIPTION

Demonstration circuit 2150A uses the [LTC®4366-2](#) and [LT4363-2](#) surge stoppers to satisfy MIL-STD-1275D. This specification, created by the United States Department of Defense, sets down requirements of electrical systems powered from a military vehicle's 28V power supply. DC2150A's output voltage is limited to 44V when faced with MIL-STD-1275D's onerous surge, spike, and ripple conditions. In most circumstances, satisfying MIL-STD-1275D is as simple as placing this circuit in front of a 44V tolerant device. The default version, DC2150A-C, provides a minimum of 4A to the output in all conditions except the $\pm 7V$ ripple condition (14V_{peak-to-peak}). During the ripple condition, DC2150A-C provides a minimum of 2.8A to the load. Exceeding 2.8A during the input ripple condition may cause DC2150A-C to timeout and shutoff in less than

MIL-STD-1275D's one minute ripple ride-through requirement. DC2150A's MOSFETs are protected against output overloads by current limiting. Sustained overvoltage or overcurrent conditions cause the circuit to turn off after a timer delay. It automatically retries after a cooldown cycle.

DANGER! HIGH VOLTAGE TESTING SHOULD BE PERFORMED BY QUALIFIED PERSONNEL ONLY. AS A SAFETY PRECAUTION AT LEAST TWO PEOPLE SHOULD BE PRESENT DURING HIGH VOLTAGE TESTING.

Design files for this circuit board are available at <http://www.linear.com/demo/DC2150A>

LT, LTC, LTM, Linear Technology and the Linear logo are registered trademarks of Linear Technology Corporation. All other trademarks are the property of their respective owners.

PERFORMANCE SUMMARY

Specifications for DC2150A-C are at $T_A = 25^\circ C$

PARAMETER	CONDITIONS	MIN	TYP	MAX	UNITS
Input Supply	Operating	8	28	40	V
	500ms Surge	100			V
	Survival (with Optional TVS Removed)	-250		250	V
Output Regulation Voltage		41	43.6	46	V
Current Limit		4.4	5	5.6	A

QUICK START PROCEDURE

Connect a 28V supply to the input and connect a load at the output. A good output load choice is a 10Ω power resistor rated at more than 200W. If the banana jacks are used, no connections are necessary at the turrets. The green LED turns on to indicate that the output is powered.

If the load at the output sinks less than 28mA, place jumper JP1 in the 1kΩ position to preload the output (be aware that preload resistors R34 and R35 may become hot as they dissipate nearly 2W when the input is at 44V). With less than 28mA of load current, MIL-STD-1275D's repeated 100V/50ms input surge test causes capacitors C1-C12 to remain charged at 67V for an extended period of time while the output voltage is regulated to 44V. This is not harmful, but it may cause the LT4363 to timeout and shutoff Q4.

Now, lower the input voltage to 8V. The output remains powered. In fact, the output remains powered to even

lower voltages, but component tolerances, especially the MOSFET threshold voltages, prevent guaranteed operation below 8V.

Next, raise the input voltage above 50V. The output shuts off as the circuit detects a high input voltage. Once the input is brought back to 28V, the output power is automatically reapplied after a cooldown timer cycle. Be patient, it can take 30 seconds for power to be reapplied.

MIL-STD-1275D Requirements

Refer to *Linear Technology Journal* article, High Voltage Surge Stoppers Ease MIL-STD-1275D Compliance by Replacing Bulky Passive Components, and the *MIL-STD-1275D, Characteristics of 28 Volt DC Electrical Systems in Military Vehicles, United States Department of Defense Interface Standard* for a thorough description of requirements.

ASSEMBLY OPTIONS

DC2150A is available from Linear Technology as DC2150A-C. This C version provides 4A to the load during all conditions except the ripple condition, where 2.8A is available to the load for up to one minute. Exceeding 2.8A during the ripple condition may cause the circuit to timeout in less than one minute. DC2150A-C provides uninterrupted power to the load during both the 100V/500ms worst-case surge envelope of MIL-STD-1275D and the repeated 100V/50ms recommended test. (Figure 1 shows DC2150A-C riding through the 100V/500ms surge. Figure 2 shows it riding through the repeated 100V/50ms surges. Figure 5 shows DC2150A-C providing uninterrupted power during a ±7V input ripple event.)

Schematics and a bill of materials are provided for three additional assembly options. Versions DC2150A-A and DC2150A-B provide a minimum of 2A of current to the load

and ride through the 100V/50ms repeated surges specified in the MIL-STD-1275D recommended tests. These versions are not guaranteed to ride through the worst-case 500ms envelope in the MIL-STD-1275D specifications. No damage will occur, but these versions may shut off when faced with the full 100V/500ms worst-case envelope. Versions DC2150A-C and DC2150A-D provide at least 4A of current to the load and ride through the 100V/50ms repeated surges and the full worst-case 100V/500ms surge. (Refer to the MIL-STD-1275D standard and *Linear Technology Journal* article, High Voltage Surge Stoppers Ease MIL-STD-1275D Compliance by Replacing Bulky Passive Components, for a more thorough description of these requirements.) Versions DC2150A-A and DC2150A-C provide 1A and 2.8A during the ripple condition, respectively. Versions DC2150A-B and DC2150A-D shutoff immediately when ripple occurs on the input, but they have a reduced bill of materials cost.

Table 1. DC2150A Assembly Options

STUFFING OPTION	MAX LOAD	MAX LOAD DURING RIPPLE	100V/50ms SURGE (FIVE REPEATS)	100V/500ms SURGE
DC2150A-A	2A	1A	Yes	No
DC2150A-B	2A	N/A	Yes	No
DC2150A-C	4A	2.8A	Yes	Yes
DC2150A-D	4A	N/A	Yes	Yes

dc2150af

CIRCUIT OPERATION

Unless otherwise specified, the description of circuit operation that follows applies to the default assembly option DC2150A-C.

100V/500ms Surge

In MIL-STD-1275D, the worst-case MOSFET power dissipation condition occurs during the 100V input surge. The circuit shown in the schematic diagram regulates the output voltage to 44V. As a result, the circuit must drop 56V from the 100V input to the 44V output. In this MIL-STD-1275D solution, to increase power available at the output, two series MOSFETs are used. The first MOSFET's (Q3's) source is regulated to 66V by the LTC4366, while the second MOSFET's (Q4's) source is regulated to 44V by the LT4363. This reduces the power that must be dissipated in either single MOSFET.

Figures 1 and 2 show the results measured during surge

testing. The oscilloscope waveform in Figure 1 shows this circuit operating through the full 100V/500ms MIL-STD-1275D surge requirement. Figure 2 shows this circuit operating through the less stringent 100V/50ms pulses described in MIL-STD-1275D's recommended tests.

±250V Spike and Reverse Input Protection

The 250V spike condition is handled by MOSFET Q3. It is rated to withstand over 300V from drain to source, blocking the 250V spike condition seen at the input. MIL-STD-1275D specifies that the input energy is limited to 15mJ which is easily handled by this MOSFET. Figure 3 shows the results of the 250V spike measured during MIL-STD-1275D testing.

Similarly, the -250V spike test result is shown in Figure 4. In this condition, diode D4 is reverse biased during the -250V spike, blocking the spike from Q4 and the output.

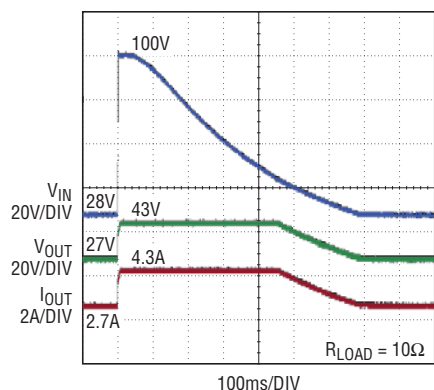

Figure 1. MIL-STD-1275D 100V/500ms Surge Test

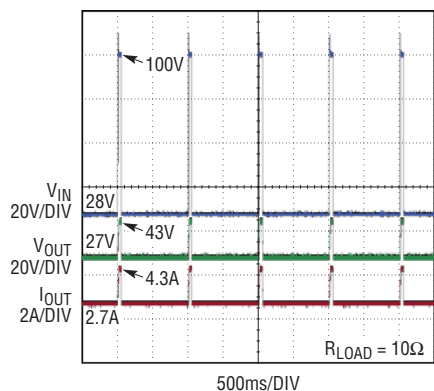

Figure 2. MIL-STD-1275D 100V/50ms Surge Repeated Five Times

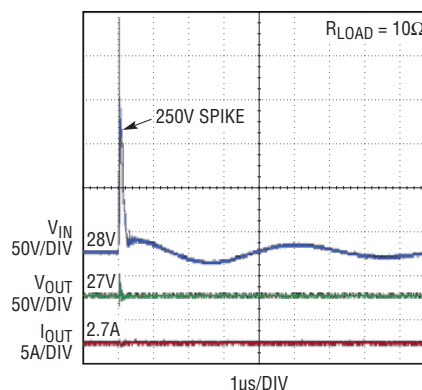

Figure 3. Positive Input Spike

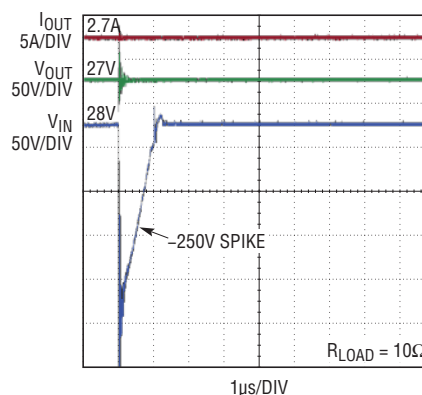

Figure 4. Negative Input Spike

CIRCUIT OPERATION

D4 additionally provides reverse polarity protection, preventing negative input voltages from showing up at the output. (The LTC4366 surge stopper in front of D4 is capable of withstanding reverse voltages and the $-250V$ spike without additional protection.)

An optional bidirectional TVS (Transient Voltage Suppressor) is present at the input to provide extra protection. Its 150V breakdown voltage does not affect circuit operation below 100V. For applications where a TVS is not desirable at the input, this optional component can be removed. Note that the output voltage trace (V_{OUT}) during the MIL-STD-1275D spike tests in Figures 3 and 4 shows high frequency ringing which is a measurement artifact of the large currents that flow in supply and ground traces when the 0.1 μF test circuit capacitor is discharged directly at the circuit input with all resistances and inductances minimized.

$\pm 7V$ Ripple

Satisfying the ripple specification of MIL-STD-1275D requires several more components. Diode D4 in combination with capacitors C1-C12 form an AC rectifier. This rectified signal appears at the RIPCAP node. The LT4363 in combination with sense resistor R3 limits the maximum current to 5A (typical). If the rising edge of the input ripple waveform attempts to pull up the output capacitor with more than 5A, the LT4363 momentarily limits the current by pulling down on Q4's gate. To quickly restore the gate voltage, the small charge pump formed by components D5, D6, C24, C25, and C26 supplements the LT4363's internal charge pump to quickly pull up MOSFET Q4's gate. Even still, the available load current must be reduced to 2.8A during this ripple condition. Figure 5 shows that the output remains powered during ripple testing.

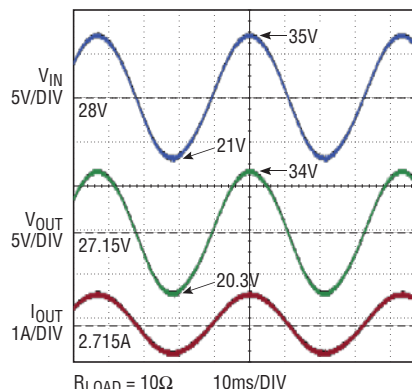

Figure 5. 14V_{p-p} Input Ripple Condition

Finally, thermal protection is implemented by components R25, R26, R27, Q6-1, Q6-2, Q5-1 and thermistor R29. If the temperature at Q4's heat sink exceeds 105°C, the LT4363's UV pin is pulled down by Q5-1 to force off MOSFET Q4 and limit its maximum temperature.

Starting Mode Initial Engagement Surge

It should also be noted that with the specified components, this circuit is only guaranteed to work down to a minimum of 8V during the starting mode initial engagement surge rather than the minimum 6V specified in MIL-STD-1275D.

DC2150A Assembly Options

Assembly options DC2150A-B and DC2150A-D eliminate capacitors C1-C12 to reduce total solution cost. In those assembly options, C25, C27, R31, R32, D7-1, and D7-2 inject a small current into the LT4363's TIMER on each rising edge of the input ripple (which appears at the SOURCE1 node). In the face of ripple, those components will force the LT4363 to timeout quickly and turn off Q4.

PCB LAYOUT

DC2150A is designed to withstand input voltages from 250V to -250V when the optional 150V bidirectional TVS DP1 is removed. The maximum positive input voltage is limited by the 300V BVDSS rating of the input MOSFET (Q1 on DC2150A-A/DC2150A-B, and Q3 on DC2150A-C/DC2150A-D). The negative input voltage is limited by the series diode (D1 on DC2150A-A/DC2150A-B, and D4 on DC2150A-C/DC2150A-D).

Upstream of the RIPCAP node, spacings and component package sizes have been chosen to support the high voltages that may be present. Traces and components downstream of the RIPCAP node are limited to less than 67V by Q1/Q3 and the LTC4366. Negative voltages are blocked from traces and components downstream of the RIPCAP node by D1/D4.

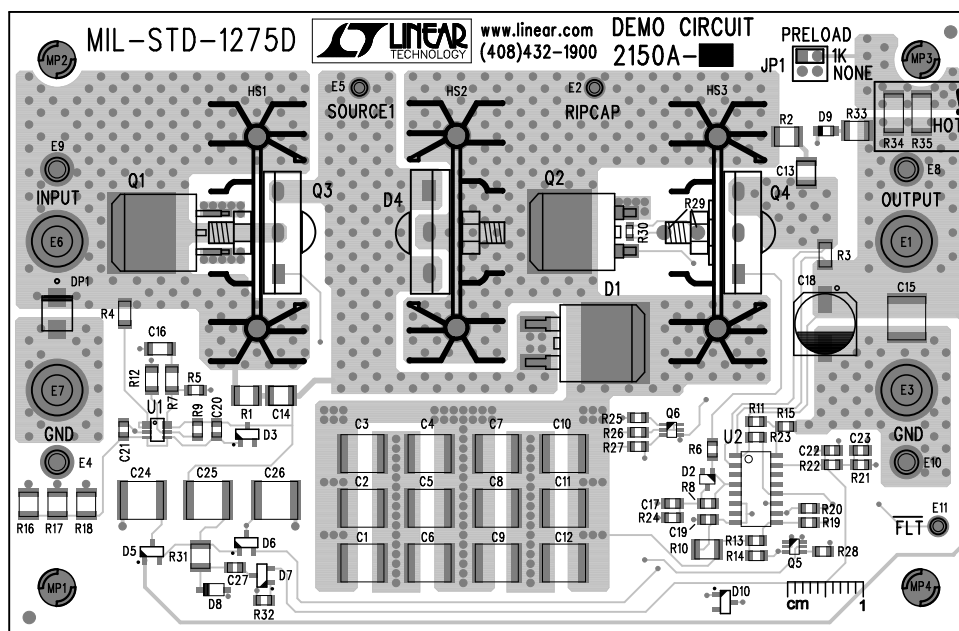

Top Silkscreen

DEMO MANUAL DC2150A

PARTS LIST

ITEM	QTY	REFERENCE	PART DESCRIPTION	MANUFACTURER/PART NUMBER
Required Circuit Components				
1	1	C13	CAP., X7R, 0.1µF, 100V 10% 1210	KEMET, C1210C104K1RAC7025
2	1	C14	CAP., X7R, 0.1µF, 500V 10% 1210	KEMET, C1210C104KCRCTU
3	0	C15, C28	CAP., OPT, 2220	OPTION
4	1	C17	CAP., X7R, 0.047µF, 100V 10% 0805	TDK, C2012X7R2A473K125AA
5	1	C18	CAP., ALUM., 68µF 50V 20% SMT	SUN ELECT., 50CE68LX
6	1	C19	CAP., X7R, 0.1µF, 100V 10% 0805	TDK, C2012X7R2A104K125AA
7	1	C20	CAP., X7R, 0.47µF, 100V 10% 0805	AVX, 08051C474KAZ2A
8	1	C22	CAP., X7R, 1µF, 16V 10% 0805	TDK, C2012X7R1C105K085AC
9	1	C25	CAP., X7R, 1µF, 250V 10% 2220	TDK, C5750X7R2E105K230KA
10	1	DP1	DIODE, TVS, OPT., SMB	VISHAY, P65MB150CA-E3/52
11	0	DP2	DIODE, TVS, OPT., SMC	OPTION
12	1	D2	DIODE, SWITCHING, SOT-323	DIODES INC., BAS21W-7-F
13	1	D3	DIODE, SCHOTTKY, 30V 200mA, SOT-23	DIODES INC., BAT54-7-F
14	1	D9	LED, GREEN, DIFFUSED, 0805	AVAGO, HSMG-C170
15	4	E1, E3, E6, E7	BANANA JACK, NON-INSULATED	KEYSTONE, 575-4
16	3	E2, E5, E11	TEST POINT, TURRET, 0.061, PBF	MILL-MAX, 2308-2-00-80-00-00-07-0
17	4	E4, E8, E9, E10	TEST POINT, TURRET, 0.094, PBF	MILL-MAX, 2501-2-00-80-00-00-07-0
18	1	JP1	HEADER, 2X2 PIN, 0.079CC	SULLINS, NRPN022PAEN-RC
19	4	MP1, MP2, MP3, MP4	STANDOFF, NYLON 0.5"	KEYSTONE, 8833 (SNAP ON)
20	2	Q5, Q6	TRANSISTOR, DUAL NPN, SOT-363	DIODES INC., MMDT5551-7-F
21	2	R1, R2	RES., CHIP, HIGH POWER, 100Ω, 3/4W, 5% 1210	VISHAY, CRCW1210100RJNEAHP
22	1	R4	RES., CHIP, 237k, 1/4W, 1% 1206	VISHAY, CRCW1206237KFKEA
23	1	R5	RES., CHIP, 100Ω, 1/8W, 1% 0805	YAGEO, RC0805FR-07100RL
24	1	R6	RES., CHIP, 10Ω, 1/8W, 5% 0805	VISHAY, CRCW080510R0JNEA
25	1	R7	RES., CHIP, 10k, 1/4W, 5% 1206	PANASONIC, ERJ-8GEYJ103V
26	1	R8	RES., CHIP, 30.1Ω, 1/8W, 1% 0805	VISHAY, CRCW080530R1FKEA
27	1	R9	RES., CHIP, 12.1k, 1/8W, 1% 0805	VISHAY, CRCW080512K1FKEA
28	1	R10	RES., CHIP, 1k, 1/2W, 1% 1210	VISHAY, CRCW1210K0OFKEA
29	2	R11, R13	RES., CHIP, 332k, 1/8W, 1% 0805	VISHAY, CRCW0805332KFKEA
30	1	R12	RES., CHIP, 649k, 1/4W, 1% 1206	VISHAY, CRCW1206649KFKEA
31	3	R14, R26, R27	RES., CHIP, 301k, 1/8W, 1% 0805	VISHAY, CRCW0805301KFKEA
32	2	R15, R19	RES., CHIP, 10k, 1/8W, 1% 0805	VISHAY, CRCW080510K0FKEA
33	3	R16, R17, R18	RES., CHIP, 18.2k, 1/2W, 1% 1210	VISHAY, CRCW121018K2FKEA
34	1	R20	RES., CHIP, 100k, 1/8W, 1% 0805	VISHAY, CRCW0805100KFKEA
35	0	R23	RES., CHIP, OPT, 0805	OPTION
36	1	R28	RES., CHIP, 1k, 1/8W, 5% 0805	NIC, NRC10J102TRF
37	1	R33	RES., CHIP, 9.31k, 1/2W, 1% 1210	PANASONIC, ERJ-14NF9311U

PARTS LIST

ITEM	QTY	REFERENCE	PART DESCRIPTION	MANUFACTURER/PART NUMBER
38	2	R34, R35	RES., CHIP, 2k, 1W, 1% 2010	VISHAY, CRCW20102K00FKEFHP
39	0	R36	RES., CHIP, 10M, 1/4W, 5% 1206, OPTION	PANASONIC, ERJ-8GEYJ106V (OPTION)
40	1	U1	IC, HIGH VOLTAGE SURGE STOPPER, TS8	LINEAR TECH., LTC4366HTS8-2#TRMPBF
41	1	U2	IC, HIGH VOLTAGE SURGE STOPPER WITH CURRENT LIMIT, SOIC	LINEAR TECH., LT4363HS-2#PBF
42	1	XJP1	SHUNT, 2mm	SAMTEC, 25N-BK-G

DC2150A-A Required Circuit Components

1	1	DC2150A	DC2150A GENERAL BOM	
2	12	C1-C12	CAP., X7S, 10 μ F, 100V 20% 2220	TDK, C5750X7S2A106M230KB
3	1	C16	CAP., X7R, 0.022 μ F, 100V 10% 1206	KEMET, C1206C223K1RACTU
4	1	C21	CAP., X7R, 0.22 μ F, 25V 10% 0805	KEMET, C0805C224K3RACTU
5	0	C23, C27	NOT USED	
6	2	C24, C26	CAP., X7R, 1 μ F, 250V 10% 2220	TDK, C5750X7R2E105K230KA
7	1	D1	DIODE ARRAY, TO-263	VISHAY, UHB20FCT-E3/4W
8	0	D4, D7, D8	NOT USED	
9	2	D5, D6, D10	DIODE ARRAY, SOT23	DIODES INC., MMBD3004S-7-F
10	0	HS1, HS2, HS3	NOT USED	
11	1	Q1	TRANS., MOSFET N-CH., 300V, TO-263	IXYS, IXTA36N30P
12	1	Q2	TRANS., MOSFET N-CH., 75V, TO-263	FAIRCHILD, FDB045AN08A0
13	0	Q3, Q4	NOT USED	
14	1	R3	RES., CHIP, CURRENT SENSE, 0.020 Ω , 1/2W, 1% 1206	IRC, LRC-LRF-1206LF-01-R020F
15	1	R21	RES., CHIP, 5.6M, 1/8W, 5% 0805	PANASONIC, ERJ-6GEYJ565V
16	1	R22	RES., CHIP, 0 Ω , 1/8W, 0805	YAGEO, RC0805JR-070RL
17	1	R24	RES., CHIP, 20k, 1/8W, 5% 0805	VISHAY, CRCW080520K0JNEA
18	1	R25	RES., CHIP, 4.75k, 1/8W, 1% 0805	VISHAY, CRCW08054K75FKEA
19	1	R30	THERMISTOR, PTC, 470 Ω , 0603	EPCOS, B59601A0105A062
20	0	R29, R31, R32	NOT USED	

DEMO MANUAL DC2150A

PARTS LIST

ITEM	QTY	REFERENCE	PART DESCRIPTION	MANUFACTURER/PART NUMBER
DC2150A-B Required Circuit Components				
1	1	DC2150A	DC2150A GENERAL BOM	
2	0	C1-C12	NOT USED	
3	1	C16	CAP., X7R, 0.022 μ F, 100V 10% 1206	KEMET, C1206C223K1RACTU
4	1	C21	CAP., X7R, 0.22 μ F, 25V 10% 0805	KEMET, C0805C224K3RACTU
5	0	C23, C24, C26	NOT USED	
6	1	C27	CAP., X7R, 0.033 μ F, 16V 10% 0805	KEMET, C0805C333K4RACTU
7	1	D1	DIODE ARRAY, TO-263	VISHAY, UHB20FCT-E3/4W
8	0	D4, D5, D6, D10	NOT USED	
9	1	D7	DIODE ARRAY, SOT23	CENTRAL SEMI., CMPSH-3SE
10	1	D8	DIODE, ZENER 3.3V 500mW SOD-123	DIODES INC., MMSZ5226B-7-F
11	0	HS1, HS2, HS3	NOT USED	
12	1	Q1	TRANS., MOSFET N-CH., 300V, TO-263	IXYS, IXTA36N30P
13	1	Q2	TRANS., MOSFET N-CH., 75V, TO-263	FAIRCHILD, FDB045AN08A0
14	0	Q3, Q4	NOT USED	
15	1	R3	RES., CHIP, CURRENT SENSE, 0.020 Ω , 1/2W, 1% 1206	IRC, LRC-LRF-1206LF-01-R020F
16	0	R21, R22, R24, R29	NOT USED	
17	1	R25	RES., CHIP, 4.75k, 1/8W, 1% 0805	VISHAY, CRCW08054K75FKEA
18	1	R30	THERMISTOR, PTC, 470 Ω , 0603	EPCOS, B59601A0105A062
19	1	R31	RES., CHIP, 10k, 1/2W, 5% 1210	PANASONIC, ERJ-14YJ103U
20	1	R32	RES., CHIP, 100k, 1/8W, 5% 0805	YAGEO, RC0805JR-07100KL

PARTS LIST

ITEM	QTY	REFERENCE	PART DESCRIPTION	MANUFACTURER/PART NUMBER
DC2150A-C Required Circuit Components				
1	1	DC2150A	DC2150A GENERAL BOM	
2	12	C1-C12	CAP., X7S, 22 μ F, 100V 20% 2220	TDK, CKG57NX7S2A226M500JH
3	1	C16	CAP., X7R, 0.015 μ F, 100V 10% 1206	KEMET, C1206C153K1RACTU
4	1	C21	CAP., X7R, 2.2 μ F, 25V 10% 0805	TDK, CGA4J3X7R1E225K125AB
5	1	C23	CAP., X7R, 10 μ F, 16V 10% 0805	SAMSUNG, CL21B106K0QNNNE
6	2	C24, C26	CAP., X7R, 1 μ F, 250V 10% 2220	TDK, C5750X7R2E105K230KA
7	0	C27	NOT USED	
8	0	D1, D7, D8	NOT USED	
9	1	D4	DIODE ARRAY, TO-247	VISHAY, FEP30GP-E3/45
10	3	D5, D6, D10	DIODE ARRAY, SOT23	DIODES INC., MMBD3004S-7-F
11	3	HS1, HS2, HS3	HEATSINK, VERTICAL MOUNT	ASSMANN WSW COMPONENTS, V8813X
12	0	Q1, Q2	NOT USED	
13	1	Q3	TRANS., MOSFET N-CH., 300V, TO-3P	IXYS, IXTQ88N30P
14	1	Q4	TRANS., MOSFET N-CH., 100V, TO-3P	IXYS, IXTQ170N10P
15	1	R3	RES., CHIP, CURRENT SENSE, 0.010 Ω , 1/2W, 1% 1206	IRC, LRC-LRF-1206LF-01-R010F
16	1	R21	RES., CHIP, 5.6M, 1/8W, 5% 0805	PANASONIC, ERJ-6GEYJ565V
17	1	R22	RES., CHIP, 6.19k, 1/8W, 1% 0805	VISHAY, CRCW08056K19FKEA
18	1	R24	RES., CHIP, 20k, 1/8W, 5% 0805	VISHAY, CRCW080520K0JNEA
19	1	R25	RES., CHIP, 1k, 1/8W, 1% 0805	VISHAY, CRCW08051K00FKEA
20	1	R29	THERMISTOR, PTC, 100 Ω , RADIAL LEAD	EPCOS, B59901D100A40
21	0	R30, R31, R32	NOT USED	

DEMO MANUAL DC2150A

PARTS LIST

ITEM	QTY	REFERENCE	PART DESCRIPTION	MANUFACTURER/PART NUMBER
DC2150A-D Required Circuit Components				
1	1	DC2150A	DC2150A GENERAL BOM	
2	0	C1-C12, C24, C26	NOT USED	
3	1	C16	CAP., X7R, 0.015 μ F, 100V 10% 1206	KEMET, C1206C153K1RACTU
4	1	C21	CAP., X7R, 2.2 μ F, 25V 10% 0805	TDK, CGA4J3X7R1E225K125AB
5	1	C23	CAP., X7R, 10 μ F, 16V 10% 0805	SAMSUNG, CL21B106K0QNNNE
6	1	C27	CAP., X7R, 0.033 μ F, 16V 10% 0805	KEMET, C0805C333K4RACTU
7	0	D1, D5, D6, D10	NOT USED	
8	1	D4	DIODE ARRAY, TO-247	VISHAY, FEP30GP-E3/45
9	1	D7	DIODE ARRAY, SOT23	CENTRAL SEMI., CMPSH-3SE
10	1	D8	DIODE, ZENER 3.3V 500mW SOD-123	DIODES INC., MMSZ5226B-7-F
11	3	HS1, HS2, HS3	HEATSINK, VERTICAL MOUNT	ASSMANN WSW COMPONENTS, V8813X
12	0	Q1, Q2	NOT USED	
13	1	Q3	TRANS., MOSFET N-CH., 300V, TO-3P	IXYS, IXTQ88N30P
14	1	Q4	TRANS., MOSFET N-CH., 100V, TO-3P	IXYS, IXTQ170N10P
15	1	R3	RES., CHIP, CURRENT SENSE, 0.010 Ω , 1/2W, 1% 1206	IRC, LRC-LRF-1206LF-01-R010F
16	1	R22	RES., CHIP, 6.19k, 1/8W, 1% 0805	VISHAY, CRCW08056K19FKEA
17	1	R25	RES., CHIP, 1k, 1/8W, 1% 0805	VISHAY, CRCW08051K00FKEA
18	1	R29	THERMISTOR, PTC, 100 Ω , RADIAL LEAD	EPCOS, B59901D100A40
19	1	R31	RES., CHIP, 10k, 1/2W, 5% 1210	PANASONIC, ERJ-14YJ103U
20	1	R32	RES., CHIP, 100k, 1/8W, 5% 0805	YAGEO, RC0805JR-07100KL
21	0	R21, R24, R30	NOT USED	

SCHEMATIC DIAGRAM

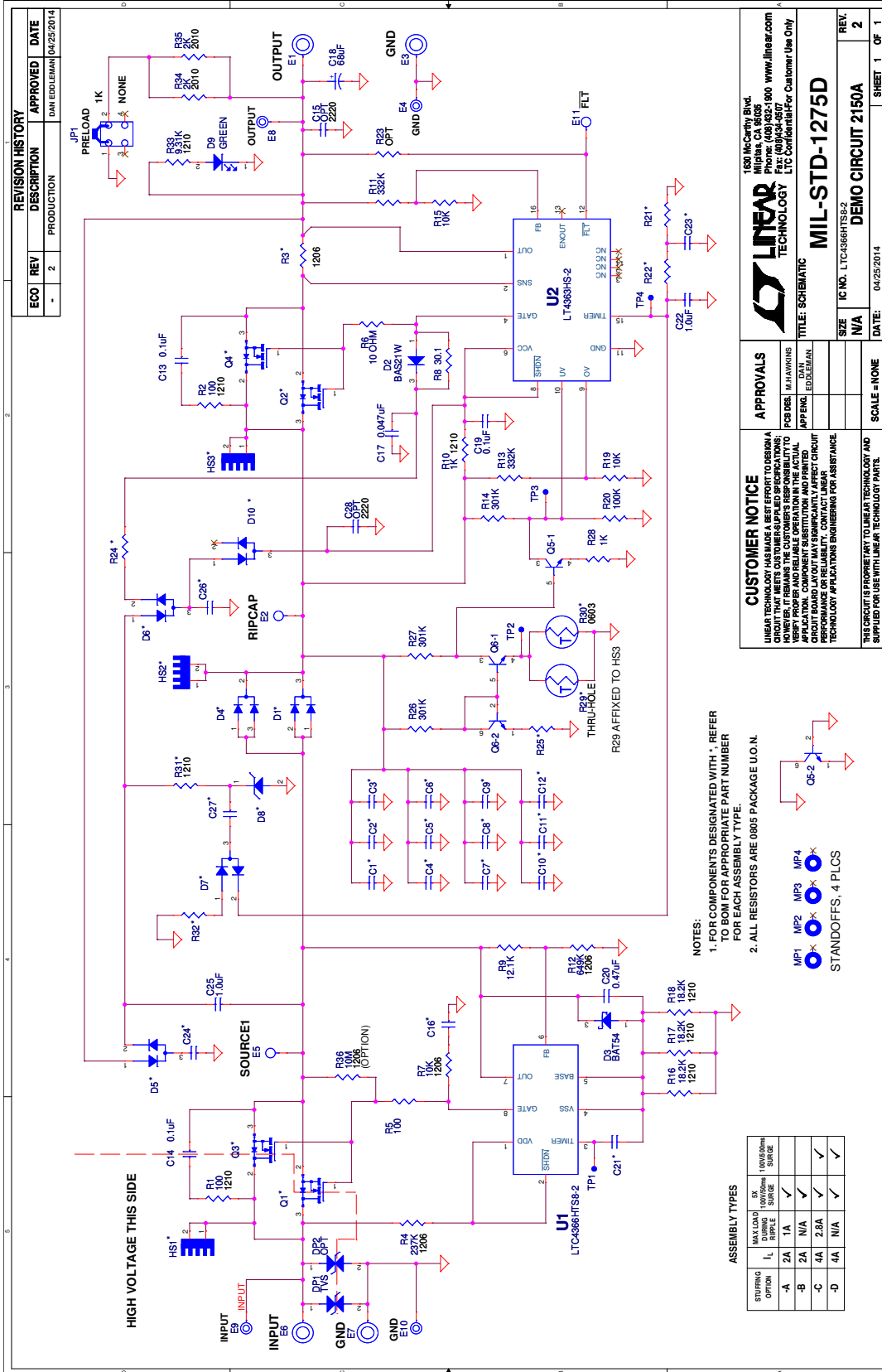

Information furnished by Linear Technology Corporation is believed to be accurate and reliable. However, no responsibility is assumed for its use. Linear Technology Corporation makes no representation that the interconnection of its circuits as described herein will not infringe on existing patent rights.

DEMO MANUAL DC2150A

DEMONSTRATION BOARD IMPORTANT NOTICE

Linear Technology Corporation (LTC) provides the enclosed product(s) under the following **AS IS** conditions:

This demonstration board (DEMO BOARD) kit being sold or provided by Linear Technology is intended for use for **ENGINEERING DEVELOPMENT OR EVALUATION PURPOSES ONLY** and is not provided by LTC for commercial use. As such, the DEMO BOARD herein may not be complete in terms of required design-, marketing-, and/or manufacturing-related protective considerations, including but not limited to product safety measures typically found in finished commercial goods. As a prototype, this product does not fall within the scope of the European Union directive on electromagnetic compatibility and therefore may or may not meet the technical requirements of the directive, or other regulations.

If this evaluation kit does not meet the specifications recited in the DEMO BOARD manual the kit may be returned within 30 days from the date of delivery for a full refund. **THE FOREGOING WARRANTY IS THE EXCLUSIVE WARRANTY MADE BY THE SELLER TO BUYER AND IS IN LIEU OF ALL OTHER WARRANTIES, EXPRESSED, IMPLIED, OR STATUTORY, INCLUDING ANY WARRANTY OF MERCHANTABILITY OR FITNESS FOR ANY PARTICULAR PURPOSE. EXCEPT TO THE EXTENT OF THIS INDEMNITY, NEITHER PARTY SHALL BE LIABLE TO THE OTHER FOR ANY INDIRECT, SPECIAL, INCIDENTAL, OR CONSEQUENTIAL DAMAGES.**

The user assumes all responsibility and liability for proper and safe handling of the goods. Further, the user releases LTC from all claims arising from the handling or use of the goods. Due to the open construction of the product, it is the user's responsibility to take any and all appropriate precautions with regard to electrostatic discharge. Also be aware that the products herein may not be regulatory compliant or agency certified (FCC, UL, CE, etc.).

No License is granted under any patent right or other intellectual property whatsoever. **LTC assumes no liability for applications assistance, customer product design, software performance, or infringement of patents or any other intellectual property rights of any kind.**

LTC currently services a variety of customers for products around the world, and therefore this transaction **is not exclusive**.

Please read the DEMO BOARD manual prior to handling the product. Persons handling this product must have electronics training and observe good laboratory practice standards. **Common sense is encouraged.**

This notice contains important safety information about temperatures and voltages. For further safety concerns, please contact a LTC application engineer.

Mailing Address:

Linear Technology
1630 McCarthy Blvd.
Milpitas, CA 95035

Copyright © 2004, Linear Technology Corporation