

## Thermally-Enhanced High Power RF LDMOS FETs 100 W, 1930 – 1990 MHz

### Description

The PTFA191001E and PTFA191001F are thermally-enhanced, 100-watt, internally-matched LDMOS FETs intended for WCDMA, IS-95 and CDMA2000 applications. They are characterized for single- and two-carrier WCDMA operation from 1930 to 1990 MHz. Thermally-enhanced packaging provides the coolest operation available.

PTFA191001E  
 Package H-36248-2



PTFA191001F  
 Package H-37248-2

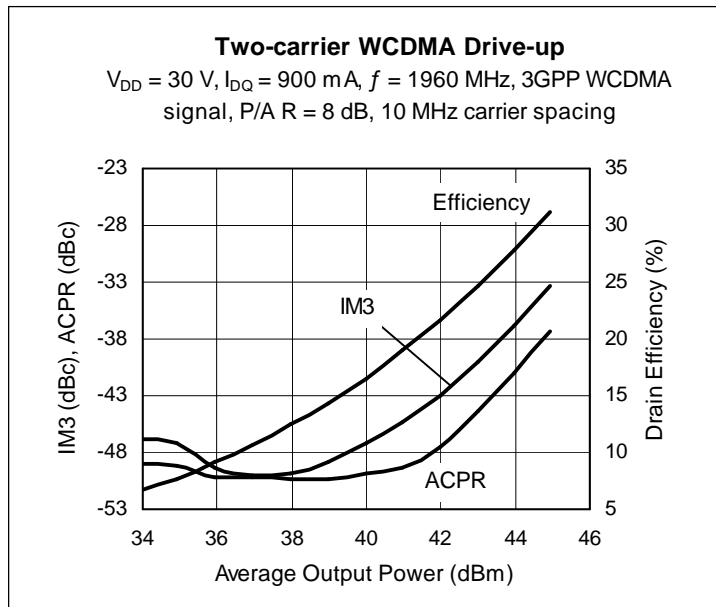

### Features

- Thermally-enhanced packages, Pb-free and RoHS-compliant
- Broadband internal matching
- Typical two-carrier WCDMA performance at 1960 MHz, 30 V
  - Average output power = 25 W
  - Linear Gain = 17.0 dB
  - Efficiency = 27.5%
  - Intermodulation distortion = -37 dBc
  - Adjacent channel power = -41.0 dBc
- Typical two-carrier IS-95 performance at 1930 MHz, 30 V
  - Average output power = 25 W
  - Efficiency = 28%
  - Intermodulation distortion = -35 dBc @ 1.2288
  - Adjacent channel power = -51 dBm
- Typical CW performance, 1960 MHz, 30 V
  - Output power at P-1dB = 130 W
  - Efficiency = 56%
- Integrated ESD protection: Human Body Model, Class 2 (minimum)
- Excellent thermal stability, low HCI drift
- Capable of handling 10:1 VSWR @ 30 V, 100 W (CW) output power

All published data at  $T_{CASE} = 25^{\circ}\text{C}$  unless otherwise indicated

**ESD:** Electrostatic discharge sensitive device—observe handling precautions!

## RF Characteristics

### WCDMA Measurements (tested in Infineon test fixture)

$V_{DD} = 30\text{ V}$ ,  $I_{DQ} = 900\text{ mA}$ ,  $P_{OUT} = 44\text{ dBm}$  average

$f_1 = 1955\text{ MHz}$ ,  $f_2 = 1965\text{ MHz}$ , 3GPP signal, channel bandwidth = 3.84 MHz, peak/average = 8 dB @ 0.01% CCDF

Characteristic	Symbol	Min	Typ	Max	Unit
Gain	$G_{ps}$	16	17.0	—	dB
Drain Efficiency	$\eta_D$	26	28	—	%
Intermodulation Distortion	IMD	—	-37	-35	dBc

## DC Characteristics

Characteristic	Conditions	Symbol	Min	Typ	Max	Unit
Drain-Source Breakdown Voltage	$V_{GS} = 0\text{ V}$ , $I_{DS} = 10\text{ mA}$	$V_{(BR)DSS}$	65	—	—	V
Drain Leakage Current	$V_{DS} = 28\text{ V}$ , $V_{GS} = 0\text{ V}$	$I_{DSS}$	—	—	1.0	$\mu\text{A}$
	$V_{DS} = 63\text{ V}$ , $V_{GS} = 0\text{ V}$	$I_{DSS}$	—	—	10.0	$\mu\text{A}$
On-State Resistance	$V_{GS} = 10\text{ V}$ , $V_{DS} = 0.1\text{ V}$	$R_{DS(on)}$	—	0.08	—	$\Omega$
Operating Gate Voltage	$V_{DS} = 28\text{ V}$ , $I_{DQ} = 900\text{ mA}$	$V_{GS}$	2.0	2.5	3.0	V
Gate Leakage Current	$V_{GS} = 10\text{ V}$ , $V_{DS} = 0\text{ V}$	$I_{GSS}$	—	—	1.0	$\mu\text{A}$

## Maximum Ratings

Parameter	Symbol	Value	Unit
Drain-Source Voltage	$V_{DSS}$	65	V
Gate-Source Voltage	$V_{GS}$	-0.5 to +12	V
Junction Temperature	$T_J$	200	$^{\circ}\text{C}$
Total Device Dissipation	$P_D$	417	W
		Above 25 $^{\circ}\text{C}$ derate by	2.38
Storage Temperature Range	$T_{STG}$	-40 to +150	$^{\circ}\text{C}$
Thermal Resistance ( $T_{CASE} = 70^{\circ}\text{C}$ , 100 W CW)	$R_{\theta JC}$	0.42	$^{\circ}\text{C/W}$

## Ordering Information

Type and Version	Package Type	Package Description	Marking
PTFA191001E V4	H-36248-2	Thermally-enhanced slotted flange, single-ended	PTFA191001E
PTFA191001F V4	H-37248-2	Thermally-enhanced earless flange, single-ended	PTFA191001F

## Typical Performance (data taken in a production test fixture)

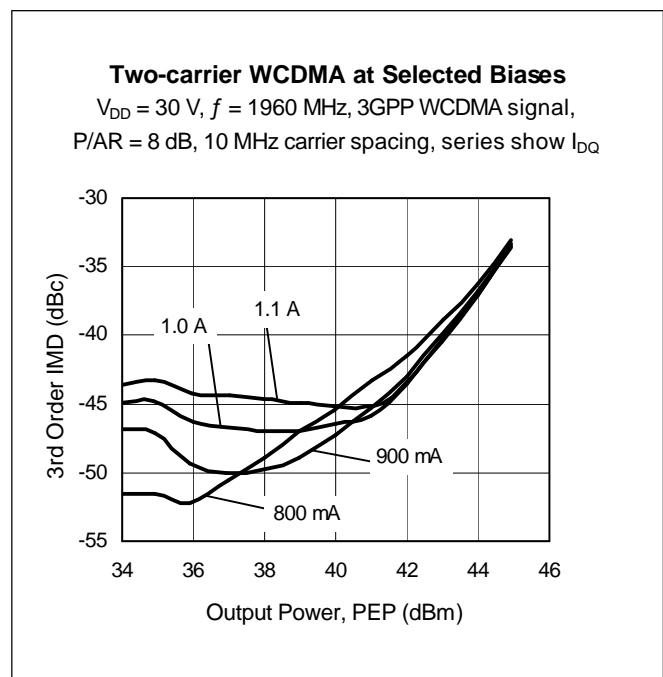
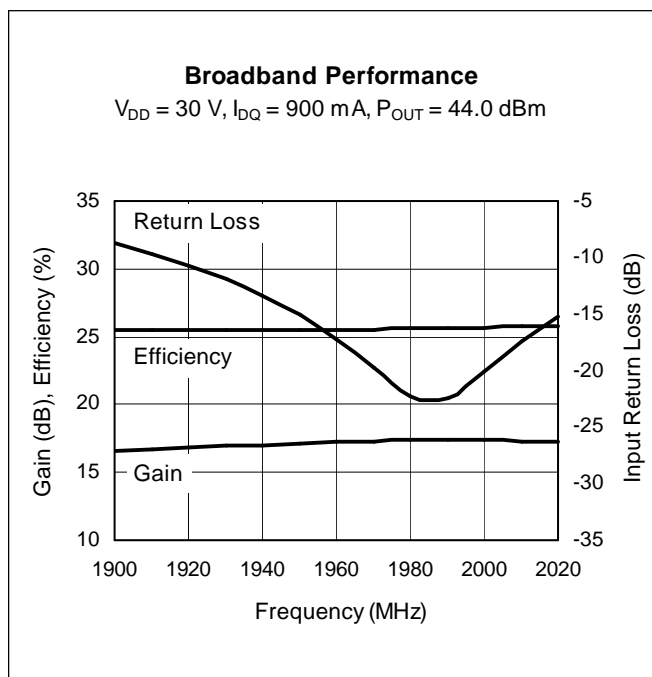

Typical Performance (cont.)

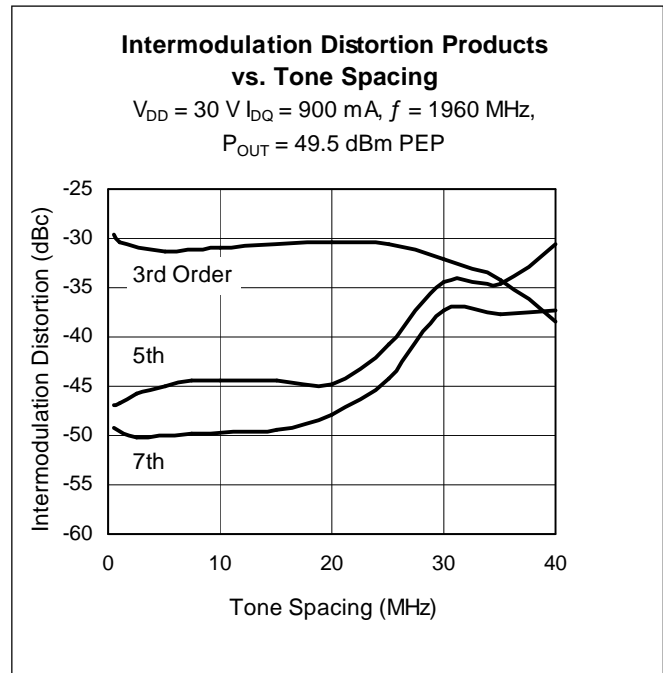
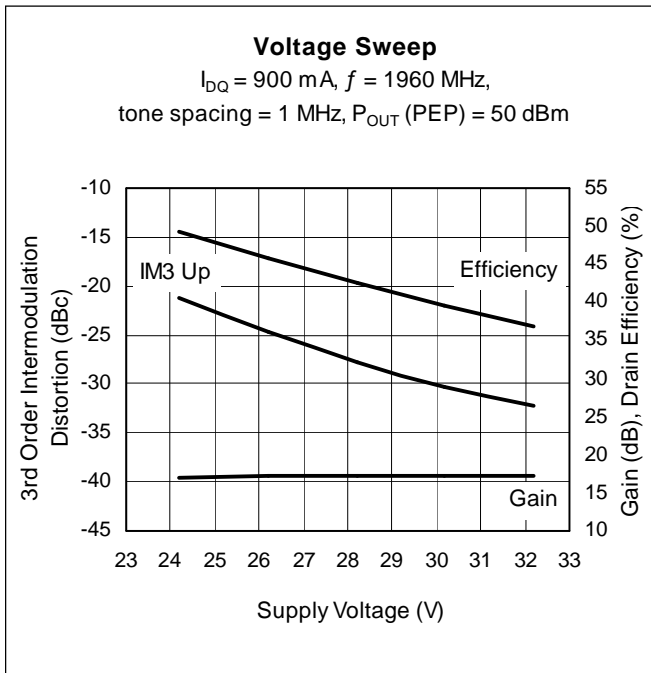
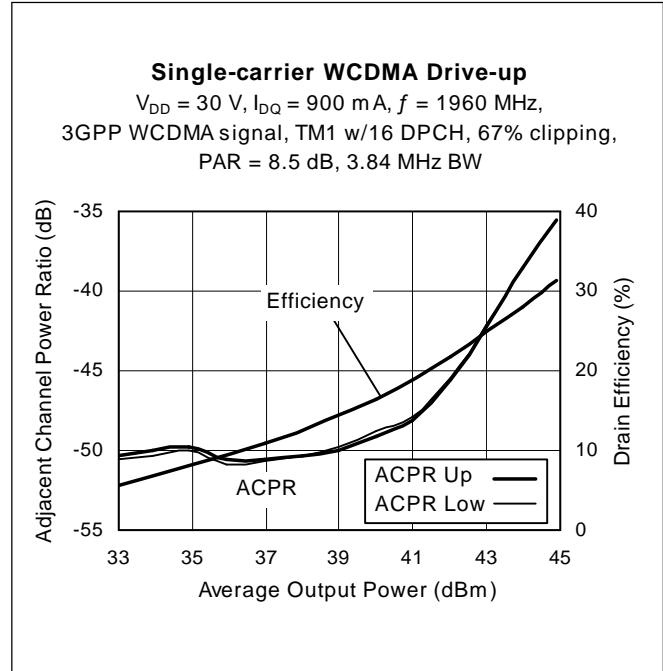
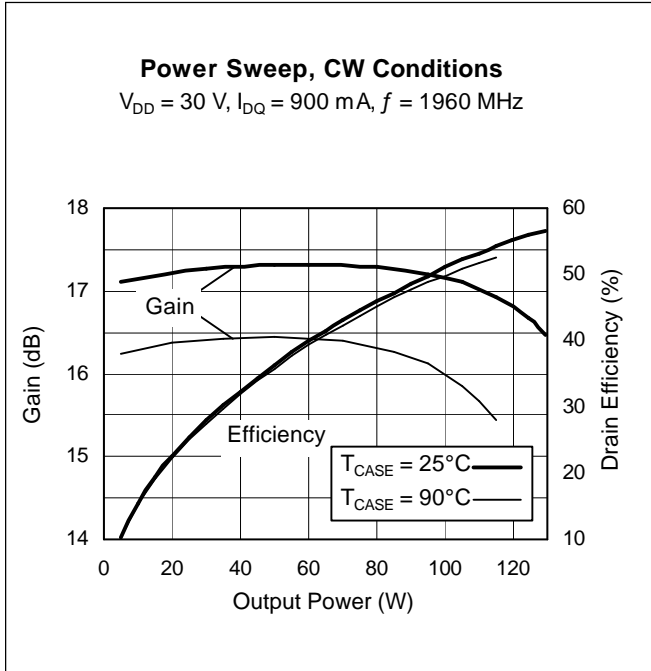

Typical Performance (cont.)

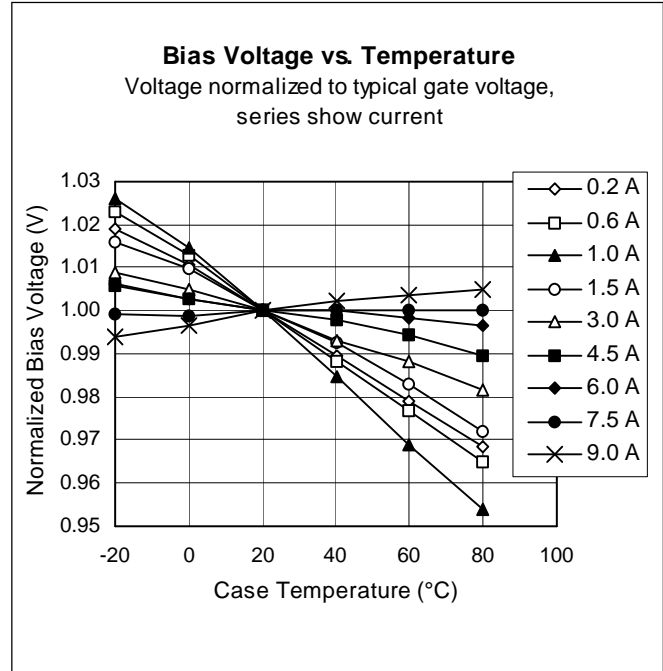
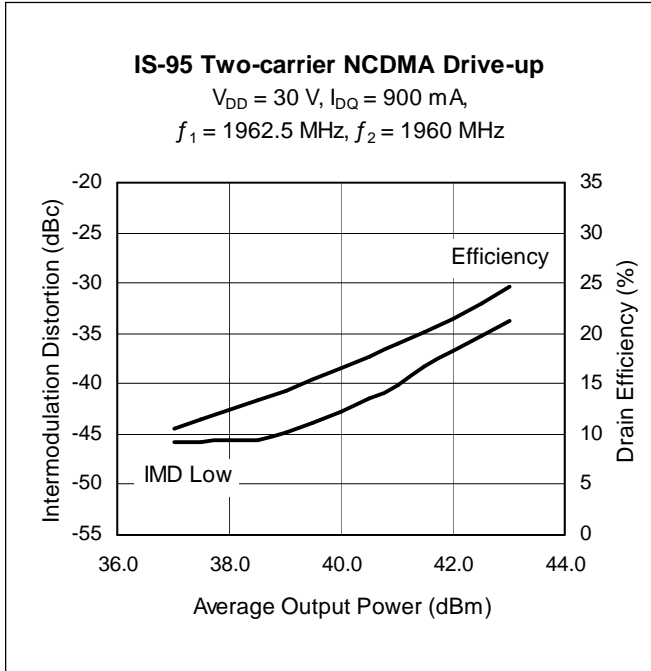

Broadband Circuit Impedance

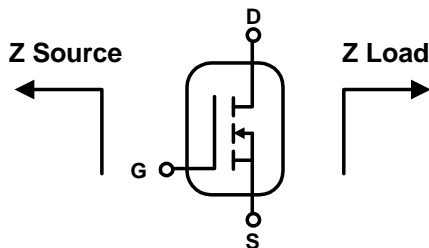

Frequency MHz	Z Source W		Z Load W	
	R	jX	R	jX
1900	5.41	-4.79	2.88	2.91
1930	5.23	-4.54	2.81	3.18
1960	5.05	-4.32	2.77	3.39
1990	4.92	-4.06	2.80	3.63
2020	4.79	-3.81	2.73	3.89

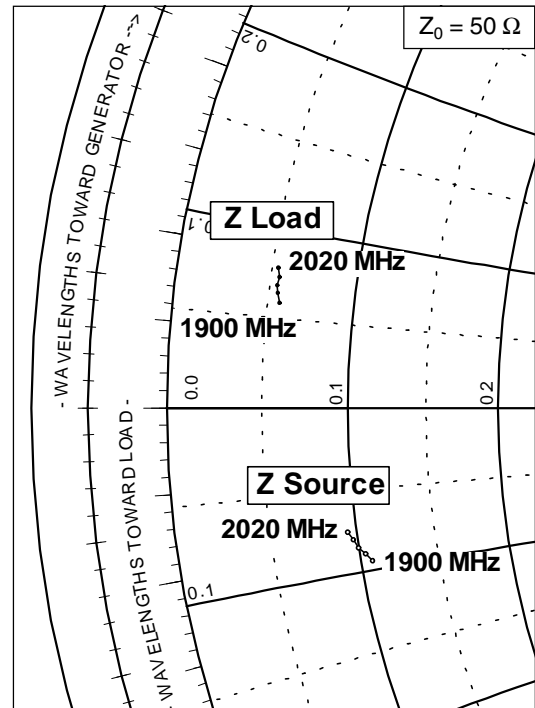

## Reference Circuit

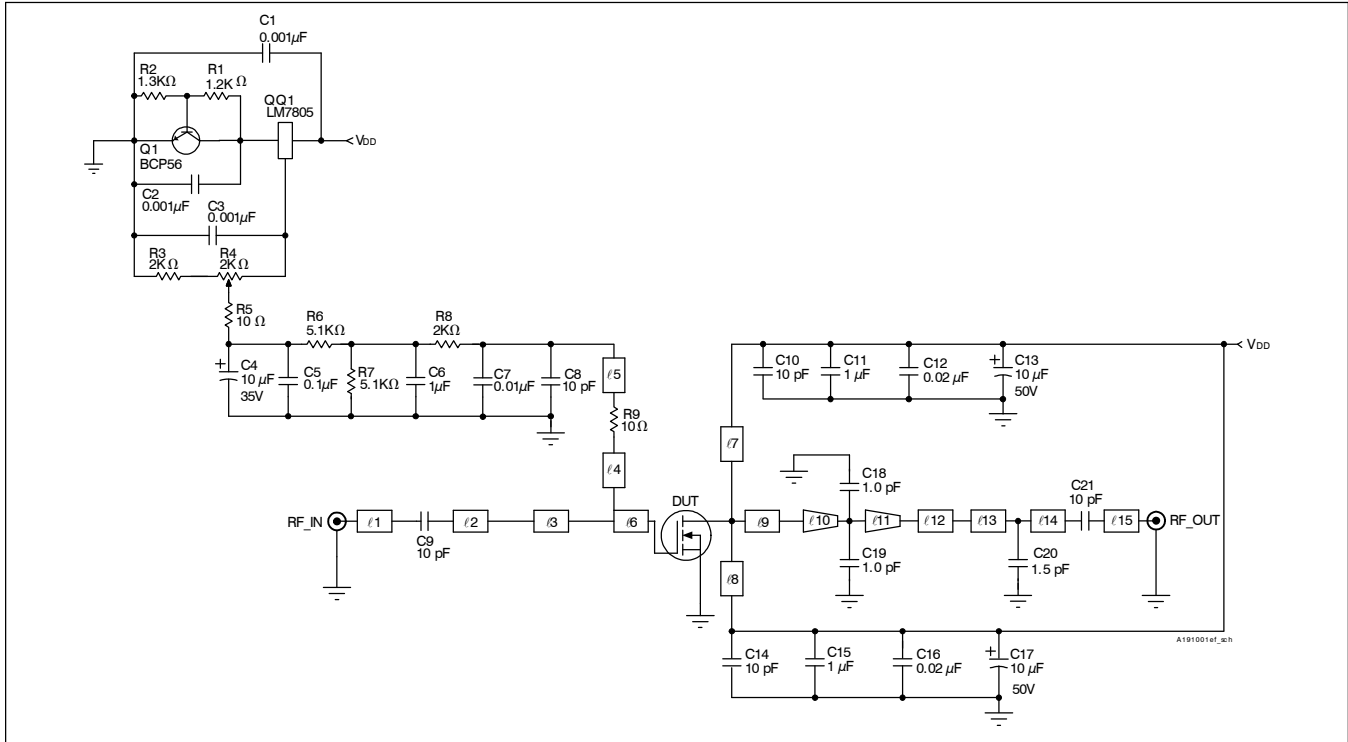

Reference circuit schematic for  $f = 1960 \text{ MHz}$

### Circuit Assembly Information

DUT	PTFA191001E or PTFA191001F	LDMOS Transistor	
PCB	0.76 mm [.030"] thick, $\epsilon_r = 4.5$	Rogers TMM4	2 oz. copper

Microstrip	Electrical Characteristics at 1960 MHz	Dimensions: L x W (mm)	Dimensions: L x W (in.)
$l_1$	$0.352 \lambda$ , $50.4 \Omega$	29.31 x 1.42	1.154 x 0.056
$l_2$	$0.183 \lambda$ , $38.0 \Omega$	14.86 x 2.16	0.585 x 0.085
$l_3$	$0.016 \lambda$ , $11.4 \Omega$	1.22 x 10.19	0.048 x 0.401
$l_4$	$0.026 \lambda$ , $60.0 \Omega$	2.16 x 0.99	0.085 x 0.039
$l_5$	$0.213 \lambda$ , $60.0 \Omega$	18.03 x 0.99	0.710 x 0.039
$l_6$	$0.069 \lambda$ , $6.9 \Omega$	5.11 x 17.86	0.201 x 0.703
$l_7$	$0.289 \lambda$ , $54.5 \Omega$	24.16 x 1.24	0.951 x 0.049
$l_8$	$0.289 \lambda$ , $54.5 \Omega$	24.16 x 1.24	0.951 x 0.049
$l_9$	$0.040 \lambda$ , $5.0 \Omega$	2.95 x 25.40	0.116 x 1.000
$l_{10}$ (taper)	$0.050 \lambda$ , $5.0 \Omega / 11.8 \Omega$	3.81 x 25.40 / 9.80	0.150 x 1.000 / 0.386
$l_{11}$ (taper)	$0.027 \lambda$ , $11.8 \Omega / 31.0 \Omega$	2.18 x 9.80 / 2.84	0.086 x 0.386 / 0.112
$l_{12}$	$0.009 \lambda$ , $31.0 \Omega$	0.76 x 2.87	0.030 x 0.113
$l_{13}$	$0.034 \lambda$ , $41.0 \Omega$	2.82 x 1.91	0.111 x 0.075
$l_{14}$	$0.086 \lambda$ , $41.0 \Omega$	7.06 x 1.91	0.278 x 0.075
$l_{15}$	$0.364 \lambda$ , $50.4 \Omega$	30.33 x 1.42	1.194 x 0.056

**Reference Circuit** (cont.)

Component	Description	Suggested Manufacturer	P/N or Comment
C1, C2, C3	Capacitor, 0.001 $\mu$ F	Digi-Key	PCC1772CT-ND
C4	Tantalum capacitor, 10 $\mu$ F, 35 V	Digi-Key	PCS6106TR-ND
C5	Capacitor, 0.1 $\mu$ F	Digi-Key	PCC104BCT-ND
C6, C11, C15	Capacitor, 1.0 $\mu$ F	Digi-Key	920C 105
C7	Capacitor, 0.01 $\mu$ F	Digi-Key	200B 103
C8, C9, C10, C14, C21	Capacitor (ceramic), 10 pF	ATC	100B 100
C12, C16	Capacitor, 0.02 $\mu$ F	Digi-Key	200B 203
C13, C17	Tantalum capacitor, 10 $\mu$ F, 50 V	Garrett Electronics	TPS106K050R0400
C18, C19	Capacitor (ceramic), 1.0 pF	ATC	100B 1R0
C20	Capacitor (ceramic), 1.5 pF	ATC	100B 1R5
Q1	Transistor	Infineon	BCP56
QQ1	Voltage regulator	National Semiconductor	LM7805
R1	Chip resistor, 1.2 k-ohms	Digi-Key	P1.2KGCT-ND
R2	Chip resistor, 1.3 k-ohms	Digi-Key	P1.3KGCT-ND
R3, R8	Chip resistor, 2 k-ohms	Digi-Key	P2KECT-ND
R4	Potentiometer, 2 k-ohms	Digi-Key	3224W-202ETR-ND
R5, R9	Chip resistor, 10 ohms	Digi-Key	P10ECT-ND
R6, R7	Chip resistor, 5.1 k-ohms	Digi-Key	P5.1KECT-ND

**See next page for reference circuit assembly diagram**

Reference Circuit (cont.)

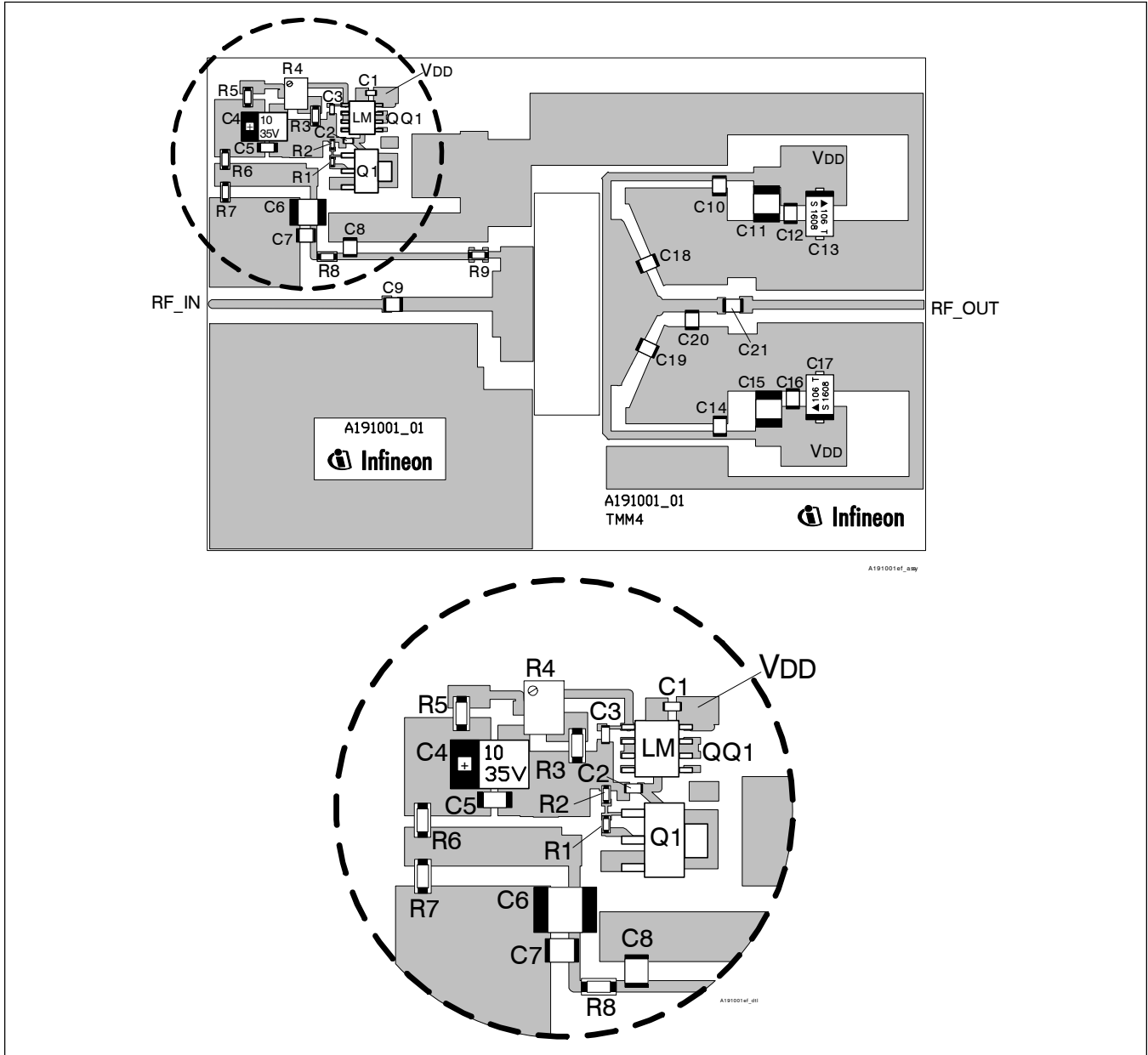

Reference circuit assembly diagram\* (not to scale)

\*Gerber Files for this circuit available on request



## Package Outline Specifications

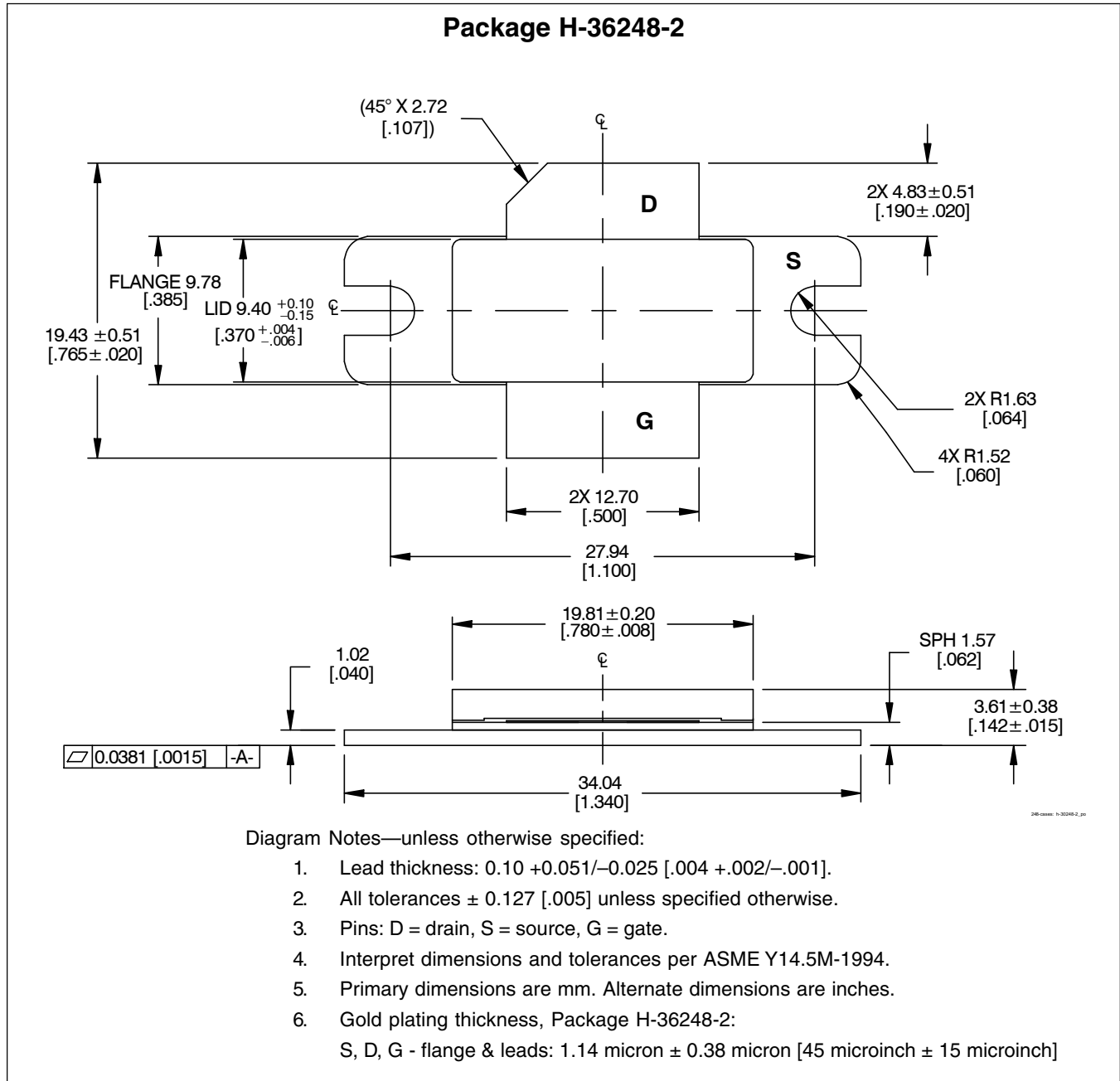

Find the latest and most complete information about products and packaging at the Infineon Internet page  
<http://www.infineon.com/products>

Package Outline Specifications (cont.)

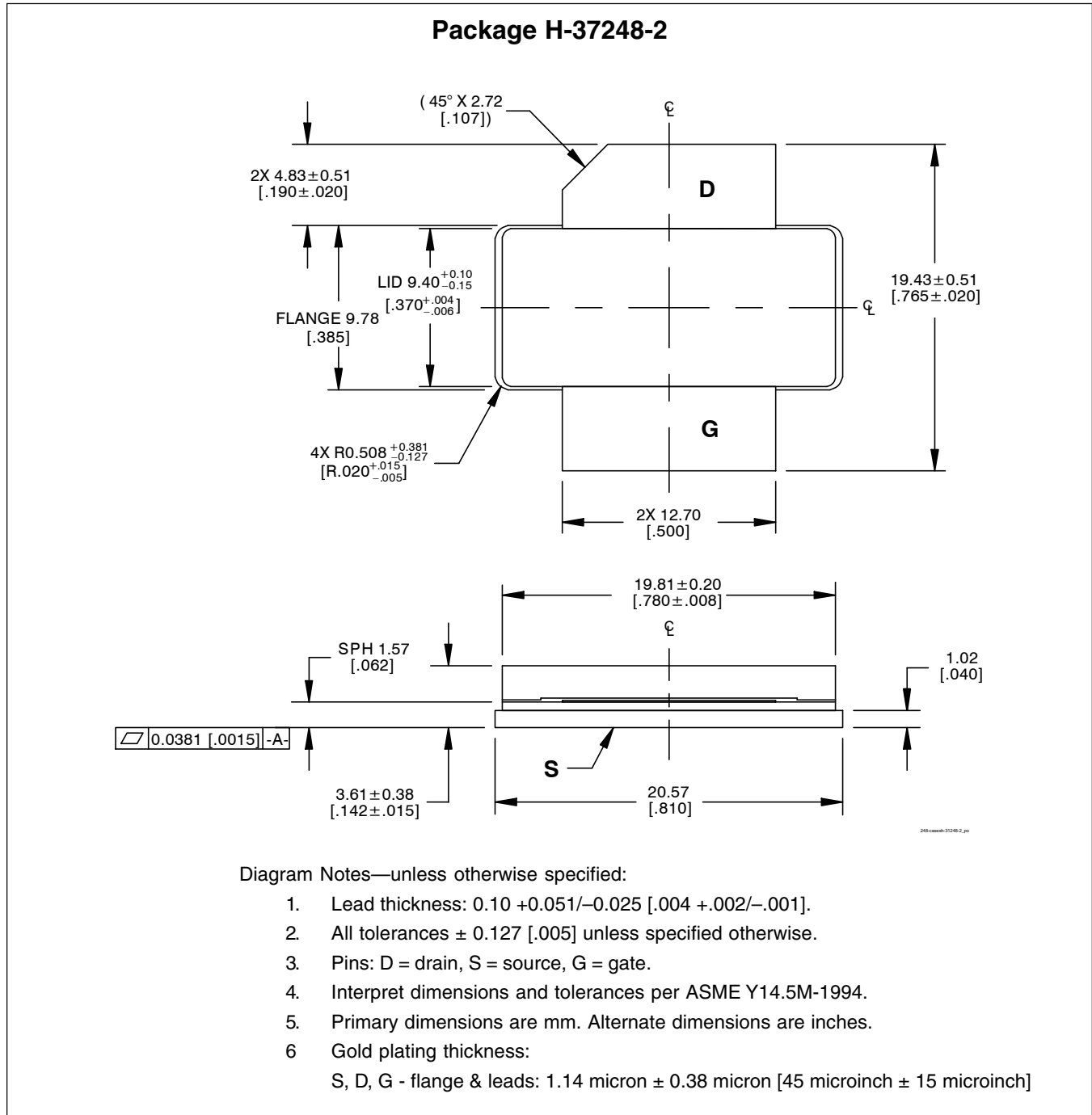

Find the latest and most complete information about products and packaging at the Infineon Internet page <http://www.infineon.com/products>

Previous Version: Rev. 02, 2005-08-11, Data Sheet; Rev. 03, 2007-06-25

Page	Subjects (major changes since last revision)
1, 10	Update company information.
1, 3, 9, 10	Update to product V4, with new package technologies. Update package outline diagrams.

**We Listen to Your Comments**

Any information within this document that you feel is wrong, unclear or missing at all?

Your feedback will help us to continuously improve the quality of this document.

Please send your proposal (including a reference to this document) to:

[highpowerRF@infineon.com](mailto:highpowerRF@infineon.com)

To request other information, contact us at:

+1 877 465 3667 (1-877-GO-LDMOS) USA

or +1 408 776 0600 International

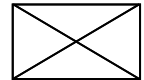
**Edition 2007-10-31****Published by**

**Infineon Technologies AG**

**81726 München, Germany**

**© Infineon Technologies AG 2004.**

**All Rights Reserved.**

**Legal Disclaimer**

The information given in this document shall in no event be regarded as a guarantee of conditions or characteristics ("Beschaffenhheitsgarantie"). With respect to any examples or hints given herein, any typical values stated herein and/or any information regarding the application of the device, Infineon Technologies hereby disclaims any and all warranties and liabilities of any kind, including without limitation warranties of non-infringement of intellectual property rights of any third party.

**Information**

For further information on technology, delivery terms and conditions and prices please contact your nearest Infineon Technologies Office ([www.infineon.com/rfpower](http://www.infineon.com/rfpower)).

**Warnings**

Due to technical requirements components may contain dangerous substances. For information on the types in question please contact your nearest Infineon Technologies Office.

Infineon Technologies Components may only be used in life-support devices or systems with the express written approval of Infineon Technologies, if a failure of such components can reasonably be expected to cause the failure of that life-support device or system, or to affect the safety or effectiveness of that device or system. Life support devices or systems are intended to be implanted in the human body, or to support and/or maintain and sustain and/or protect human life. If they fail, it is reasonable to assume that the health of the user or other persons may be endangered.