

DATA SHEET

SKY65605-21: BDS/GPS/GNSS Low-Noise Amplifier

Applications

- BDS/GPS/GNSS radio receivers
- Global Navigation Satellite Systems (GLONASS)
- Smartphones
- Tablet/laptop PCs
- Personal navigation devices

Features

- Small signal gain: 19 dB typical
- High in-band IIP3: -5 dBm
- Low noise figure: 0.6 dB typical
- High IP1dB: -14.5 dBm
- Low current consumption: 3.6 mA
- Input/output impedance internally matched to 50 Ω
- Single DC supply: 1.8 to 2.85 V
- Minimal number of external components required
- Ultra-small QFN (6-pin, 0.7 x 1.1 mm) package (MSL1, 260 °C per JEDEC J-STD-020)



Skyworks Green™ products are compliant with all applicable legislation and are halogen-free. For additional information, refer to *Skyworks Definition of Green™*, document number SQ04-0074.

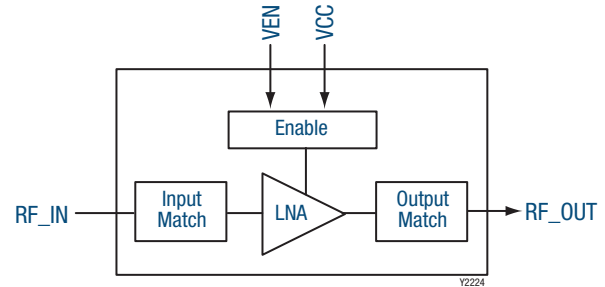

Figure 1. SKY65605-21 Block Diagram

Description

The SKY65605-21 is a Microwave Monolithic Integrated Circuit (MMIC) front-end low-noise amplifier (LNA) designed for BeiDou Satellite Navigation System/Global Positioning System/Global Navigation Satellite System (BDS/GPS/GNSS) receiver applications. The device provides high linearity, excellent gain, a high 1 dB input compression point (IP1dB), and a superior noise figure (NF).

The SKY65605-21 is optimized to operate from 1.559 to 1.606 GHz, which makes it ideal for BDS/GPS/GNSS radio receiver applications.

The SKY65605-21 is fabricated using advanced SiGe BiCMOS technology. The LNA uses surface-mount technology (SMT) in the form of a 0.7 x 1.1 mm Quad Flat No-Lead (QFN) package, which allows for a highly manufacturable and low-cost solution.

A functional block diagram is shown in Figure 1. The pin configuration and package are shown in Figure 2. Signal pin assignments and functional pin descriptions are provided in Table 1.

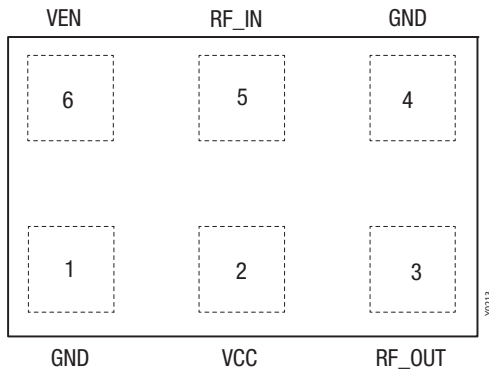

Figure 2. SKY65605-21 Pinout (Top View)

Table 1. SKY65605-21 Signal Descriptions

Pin	Name	Description	Pin	Name	Description
1	GND	Ground	4	GND	Ground
2	VCC	Source voltage	5	RF_IN	RF input
3	RF_OUT	RF output	6	VEN	LNA enable

Technical Description

Power Shutdown

The VEN signal (pin 6) enables or disables the LNA DC power. A logic high signal powers on the LNA and a logic low signal powers off the device.

Electrical and Mechanical Specifications

The absolute maximum ratings of the SKY65605-21 are provided in Table 2. The recommended operating conditions are specified in Table 3 and electrical specifications are provided in Tables 4 and 5.

Table 2. SKY65605-21 Absolute Maximum Ratings (Note 1)

Parameter	Symbol	Minimum	Maximum	Units
RF input power	P _{IN}		+10	dBm
Supply voltage	V _{CC}	0	3.1	V
Storage temperature	T _{STG}	-55	+125	°C
Junction temperature	T _J		+150	°C
Case operating temperature	T _C	-40		+85

Note 1: Exposure to maximum rating conditions for extended periods may reduce device reliability. There is no damage to device with only one parameter set at the limit and all other parameters set at or below their nominal value. Exceeding any of the limits listed here may result in permanent damage to the device.

CAUTION: Although this device is designed to be as robust as possible, electrostatic discharge (ESD) can damage this device. This device must be protected at all times from ESD. Static charges may easily produce potentials of several kilovolts on the human body or equipment, which can discharge without detection. Industry-standard ESD precautions should be used at all times.

Table 3. SKY65605-21 Recommended Operating Conditions

Parameter	Symbol	Minimum	Typical	Maximum	Units
Frequency range	f	1559	1575	1606	MHz
Supply voltage (measured at terminals of the Evaluation Board)	V _{CC}	1.50	1.80	2.85	V
LNA enable:					
Enable (high)	LNA _{ENABLE}	1.5		V _{CC}	V
Disable (low)	LNA _{DISABLE}	0		0.3	V

Table 4. SKY65605-21 Electrical Specifications (Note 1)
(VCC = 2.85 V, VEN = 1.5 V, f = 1575 MHz, Tc= +25 °C, Unless Otherwise Noted)

Parameter	Symbol	Test Condition	Min	Typical	Max	Units
Small signal gain	IS21I	PIN = -30 dBm	17	19	21	dB
1 dB input compression point	IP1dB			-14.5		dBm
Noise figure	NF			0.6 (Note 2)		dB
In-band third order input intercept point	IIP3	f1 = 1575 MHz, P1 = -30 dBm f2 = 1574 MHz, P2 = -30 dBm		-5		dBm
Out-of-band third order input intercept point	OOB-IIP3	f1 = 1713 MHz, P1 = -20 dBm f2 = 1851 MHz, P2 = -20 dBm		-2		dBm
Reverse isolation	IS12I	PIN = -30 dBm		37		dB
Input return loss	IS11I	PIN = -30 dBm		7.5		dB
Output return loss	IS22I	PIN = -30 dBm		10		dB
Supply current	Icc			3.5	4.5	mA
Shutdown current	I _{LEAK}			0.1	1.0	μA

Note 1: Performance is guaranteed only under the conditions listed in this table.

Note 2: 0.1dB has been de-embedded for input connector and trace loss.

Table 5. SKY65605-21 Electrical Specifications (Note 1)
(VCC = 1.8 V, VEN = 1.5 V, f = 1575 MHz, Tc= +25 °C, Unless Otherwise Noted)

Parameter	Symbol	Test Condition	Min	Typical	Max	Units
Small signal gain	IS21I	PIN = -30 dBm	17	18.5	20.5	dB
1 dB input compression point	IP1dB	f = 1575.0 MHz		-16 (Note 2)		dBm
Noise figure	NF			0.65		dB
In-band third order input intercept point	IIP3	f1 = 1575 MHz, P1 = -30 dBm f2 = 1574 MHz, P2 = -30 dBm		-7		dBm
Out-of-band third order input intercept point	OOB-IIP3	f1 = 1713 MHz, P1 = -20 dBm f2 = 1851 MHz, P2 = -20 dBm		-5		dBm
Reverse isolation	IS12I	PIN = -30 dBm		37		dB
Input return loss	IS11I	PIN = -30 dBm		7		dB
Output return loss	IS22I	PIN = -30 dBm		10		dB
Supply current	Icc			3.3	4.5	mA
Shutdown current	I _{LEAK}			0.1	1.0	μA

Note 1: Performance is guaranteed only under the conditions listed in this table.

Note 2: 0.1dB has been de-embedded for input connector and trace loss.

Evaluation Board Description

The SKY65605-21 Evaluation Board is used to test the performance of the SKY65605-21 LNA. Figure 3 shows the Evaluation Board schematic, and Table 6 lists the Bill of Materials (BOM) for the SKY65605-21. Figure 4 shows the Evaluation Board assembly drawing.

Package Dimensions

Typical part markings are shown in Figure 5. Package dimensions for the SKY65605-21 are shown in Figure 6, and tape and reel dimensions are provided in Figure 7.

Package and Handling Information

Instructions on the shipping container label regarding exposure to moisture after the container seal is broken must be followed. Otherwise, problems related to moisture absorption may occur when the part is subjected to high temperature during solder assembly.

The SKY65605-21 is rated to Moisture Sensitivity Level 1 (MSL1) at 260 °C. It can be used for lead or lead-free soldering. For additional information, refer to the Skyworks Application Note, *Solder Reflow Information*, document number 200164.

Care must be taken when attaching this product, whether it is done manually or in a production solder reflow environment. Production quantities of this product are shipped in a standard tape and reel format.

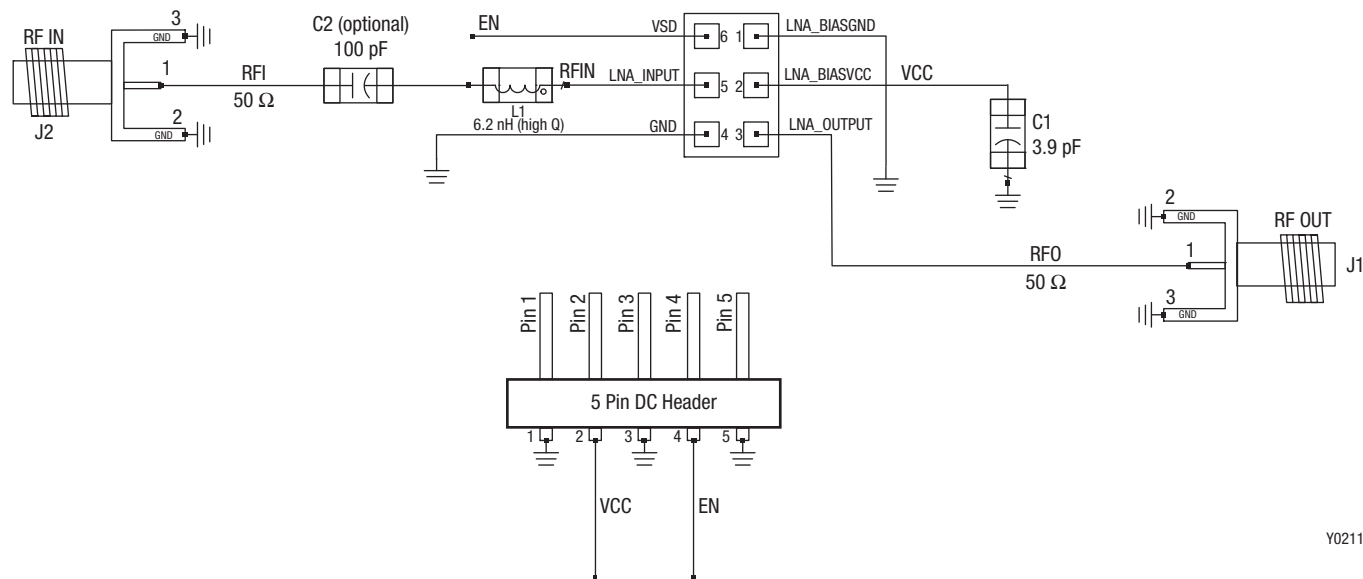

Figure 3. SKY65605-21 Evaluation Board Schematic

Table 6. SKY65605-21 Bill of Materials for the Evaluation Board

Part Number	Value	Size	Notes
C1	3.9 pF	0402	Capacitor
C2 (optional)	100 pF	0402	Capacitor
L1	6.2 nH	0402	Wire-wound HiQ inductor

Note 1: The C1 and C2 capacitors can use a 0201 size as an alternative.

Note 2: The C2 capacitor is optional if there is no DC present at the RF input.

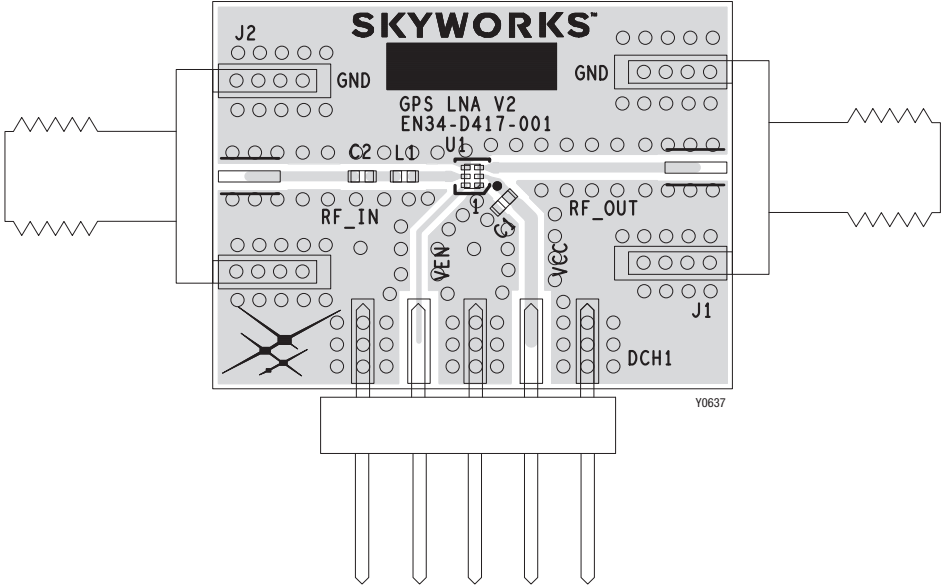

Figure 4. SKY65605-21 Evaluation Board Assembly Drawing

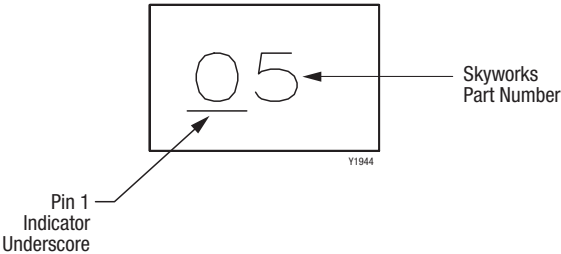

Figure 5. SKY65605-21 Typical Part Marking

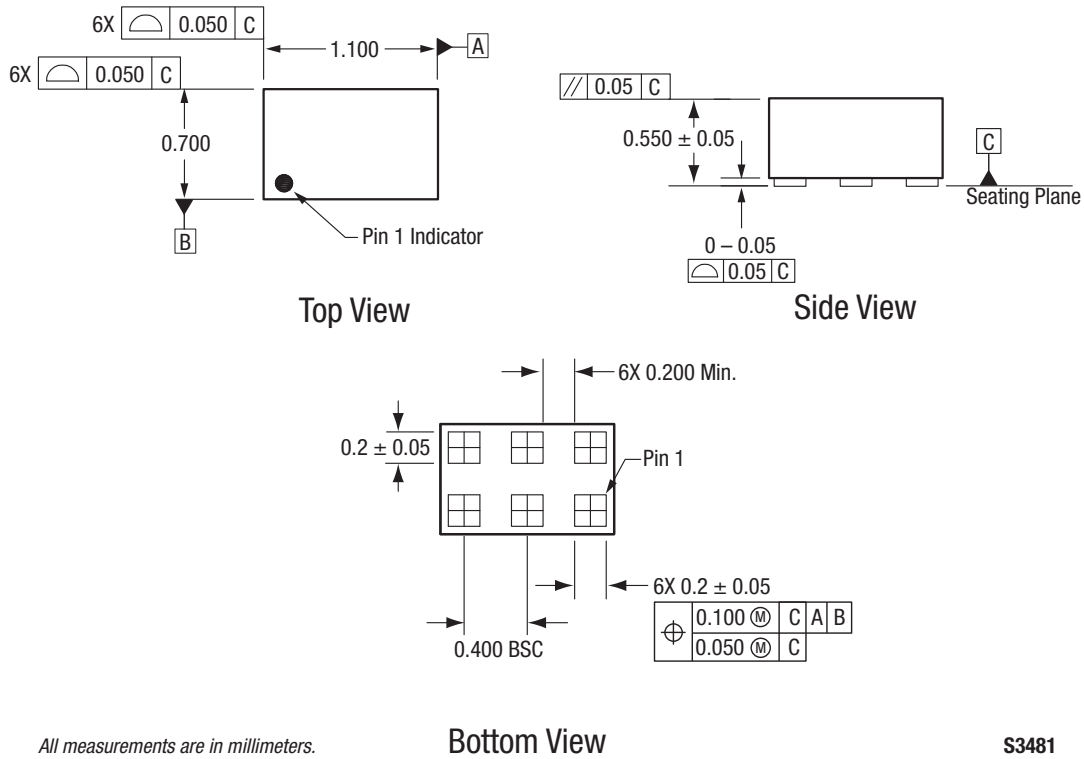

Figure 6. SKY65605-21 Package Dimensions

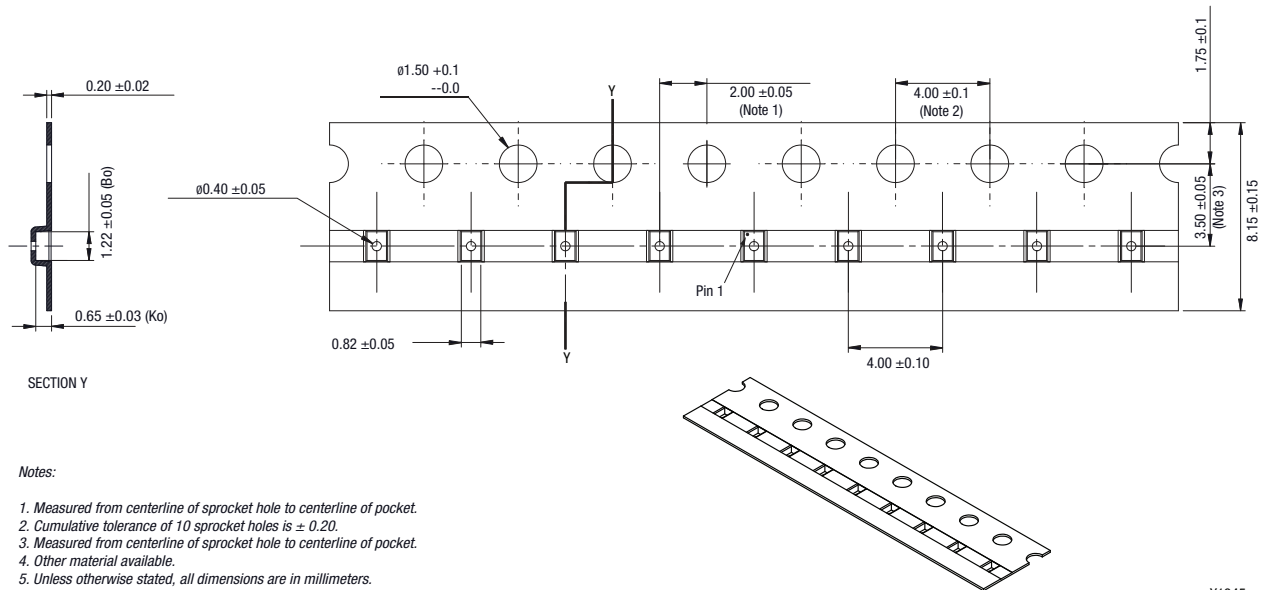

Figure 7. SKY65605-21 Tape and Reel Dimensions

Ordering Information

Model Name	Manufacturing Part Number	Evaluation Board Part Number
SKY65605-21: BDS/GPS/GNSS Low-Noise Amplifier	SKY65605-21	EN34-D417-001

Copyright © 2014-2015 Skyworks Solutions, Inc. All Rights Reserved.

Information in this document is provided in connection with Skyworks Solutions, Inc. (“Skyworks”) products or services. These materials, including the information contained herein, are provided by Skyworks as a service to its customers and may be used for informational purposes only by the customer. Skyworks assumes no responsibility for errors or omissions in these materials or the information contained herein. Skyworks may change its documentation, products, services, specifications or product descriptions at any time, without notice. Skyworks makes no commitment to update the materials or information and shall have no responsibility whatsoever for conflicts, incompatibilities, or other difficulties arising from any future changes.

No license, whether express, implied, by estoppel or otherwise, is granted to any intellectual property rights by this document. Skyworks assumes no liability for any materials, products or information provided hereunder, including the sale, distribution, reproduction or use of Skyworks products, information or materials, except as may be provided in Skyworks Terms and Conditions of Sale.

THE MATERIALS, PRODUCTS AND INFORMATION ARE PROVIDED “AS IS” WITHOUT WARRANTY OF ANY KIND, WHETHER EXPRESS, IMPLIED, STATUTORY, OR OTHERWISE, INCLUDING FITNESS FOR A PARTICULAR PURPOSE OR USE, MERCHANTABILITY, PERFORMANCE, QUALITY OR NON-INFRINGEMENT OF ANY INTELLECTUAL PROPERTY RIGHT; ALL SUCH WARRANTIES ARE HEREBY EXPRESSLY DISCLAIMED. SKYWORKS DOES NOT WARRANT THE ACCURACY OR COMPLETENESS OF THE INFORMATION, TEXT, GRAPHICS OR OTHER ITEMS CONTAINED WITHIN THESE MATERIALS. SKYWORKS SHALL NOT BE LIABLE FOR ANY DAMAGES, INCLUDING BUT NOT LIMITED TO ANY SPECIAL, INDIRECT, INCIDENTAL, STATUTORY, OR CONSEQUENTIAL DAMAGES, INCLUDING WITHOUT LIMITATION, LOST REVENUES OR LOST PROFITS THAT MAY RESULT FROM THE USE OF THE MATERIALS OR INFORMATION, WHETHER OR NOT THE RECIPIENT OF MATERIALS HAS BEEN ADVISED OF THE POSSIBILITY OF SUCH DAMAGE.

Skyworks products are not intended for use in medical, lifesaving or life-sustaining applications, or other equipment in which the failure of the Skyworks products could lead to personal injury, death, physical or environmental damage. Skyworks customers using or selling Skyworks products for use in such applications do so at their own risk and agree to fully indemnify Skyworks for any damages resulting from such improper use or sale.

Customers are responsible for their products and applications using Skyworks products, which may deviate from published specifications as a result of design defects, errors, or operation of products outside of published parameters or design specifications. Customers should include design and operating safeguards to minimize these and other risks. Skyworks assumes no liability for applications assistance, customer product design, or damage to any equipment resulting from the use of Skyworks products outside of stated published specifications or parameters.

Skyworks and the Skyworks symbol are trademarks or registered trademarks of Skyworks Solutions, Inc., in the United States and other countries. Third-party brands and names are for identification purposes only, and are the property of their respective owners. Additional information, including relevant terms and conditions, posted at www.skyworksinc.com, are incorporated by reference.