

GlobTek, Inc.  
www.globtek.com  
186 Veterans Drive,  
Northvale, NJ 07647  
Tel. (201) 784-1000  
Fax (201) 784-0111

Drawing Title: GT-46600-6012-T3, ITE Power Supply, Efficiency Level: VI, Case Color/Style: GlobTek Black, Desktop/External, Regulated Switchmode AC-DC Power Supply AC Adaptor, Input Rating: 100-240V~, 50-60 Hz, IEC 60320/C14, Output Rating: 60W, 12V@5A, Output Configuration: 1200 mm, 16/2 Cond, UL 2468, Female Barrel 5.5 \* 2.5 \* 11mm with internal Spring Clip and Locking Notch or Equal, Ferrite: Core Size: 14.2\*28.5\*8.2, GlobTek Black, GT Cord # C2286, Pin Out: Center Positive (+V), Blades/Input Cord: Not Applicable, Approvals: 230V CoC Tier 2 Saudi Malaysia Singapore Taiwan BSMI CB EAC EAC BIS South Africa NOM FCC IRAM CE CE China RoHS Class I Level VI LPS RoHS Ukraine VCCI WEEE cULus PSE PSE CAN ICES-3 CCC Korea (12V Only) SGS (Brazil) FCC RCM

Model No. GT-46600-6012-T3

Part No./Ordering No. TR9CE5000LCP-N(R6B)

Rev I

## REVISION HISTORY

REV	DESCRIPTION	SUB	DATE	APPROVED
I	Update packing drawing: change PE bag dimensions from 90*300 mm to 100*300 mm	QA	07/05/2018	QA
H	Add South African EMI/EMC to approvals	QA	06/27/2018	QA
G3	Add BIS (India) approval.	bsiep	03/21/2018	QA
G2	Add approvals: EAC(Russia), BSMI(Taiwan), Malaysia, Singapore, Saudi Arabia	QA	01/04/2018	QA
G1	Update Ukraine No.	rchiu	10/25/2017	QA
G	Add grounding configuration	QA	01/12/2017	QA
F	Add Grounding Configuration drawing; Add CCC, FCC, CAN ICES, KOREA, IRAM, NOM, RCM, and SGS-GS	bsiep	12/06/2016	QA
E	Update regulatory approvals.	emcna	04/21/2016	QA
D	Remove Gift Box Color: White	QA	10/19/2015	QA
C	Update ferrite distance from connector from 50mm to 150mm.	bsiep	07/24/2015	QA
B	Change GT-43105-6012-T3 to GT-46600-6012-T3, change CQC-PSE to TUV-PSE, Master Carton Size to 520*370*205mm.	QA	07/10/2015	QA
A	Initial release.	QA	06/17/2015	QA

In Addition to GlobTek Inc.'s renewed ISO9001:2008 - Quality Management System Certification, GlobTek Inc. is now certified to:

ISO13485:2003 - Medical Devices Quality Management System Certification

ISO14001:2004 - Environmental Management System Certification

ISO Certificates are available online at <http://www.globtek.com/iso-certificates/>

### Customer Approval of Specification:

Please approve, sign and send back to GlobTek so we can complete order processing.

A delay in receipt of this form will delay delivery schedule.

Company Name:

Customer P/N:

Quote Number:

Date:

Authorized Representative Name:

Authorized Representative Signature:

The acceptance of this specification and use of the product described in this document indicates the acceptance and binding of the customer to Globtek terms and conditions, which supersede all other agreements, terms, and conditions (<http://en.globtek.com/terms-and-conditions/>).

### Footnote:

GlobTek Inc. will not be liable for the safety and performance of these power supplies if unauthorized access and repair occurs. End user should consult applicable UL, CSA or EN standards for proper installation instruction.

GT-46600-6012-T3, 60W, 12V@5A, Desktop/External, Regulated Switchmode AC-DC Power Supply AC Adaptor

PROPRIETARY INFORMATION

PROPRIETARY OF GLOBTEK, INC. ANY REPRODUCTION, DISCLOSURE OR USE OF THIS DRAWING, IN WHOLE OR IN PART, IS HEREBY PROHIBITED EXCEPT AS SPECIFIED IN WRITING BY GLOBTEK, INC.

Page 1 of 13

quest /08/21/2018 8:07:56 AM

GlobTek, Inc.  
www.globtek.com  
186 Veterans Drive,  
Northvale, NJ 07647  
Tel. (201) 784-1000  
Fax (201) 784-0111

Drawing Title: GT-46600-6012-T3, ITE Power Supply, Efficiency Level: VI, Case Color/Style: GlobTek Black, Desktop/External, Regulated Switchmode AC-DC Power Supply AC Adaptor, Input Rating: 100-240V~, 50-60 Hz, IEC 60320/C14 , Output Rating: 60W, 12V@5A, Output Configuration: 1200 mm, 16/2 Cond, UL 2468, Female Barrel 5.5 \* 2.5 \* 11mm with internal Spring Clip and Locking Notch or Equal, Ferrite: Core Size: 14.2\*28.5\*8.2, GlobTek Black, GT Cord # C2286, Pin Out: Center Positive (+V), Blades/Input Cord: Not Applicable, Approvals: 230V CoC Tier 2 Saudi Malaysia Singapore Taiwan BSMI CB EAC EAC BIS South Africa NOM FCC IRAM CE CE China RoHS Class I Level VI LPS RoHS Ukraine VCCI WEEE cULus PSE PSE CAN ICES-3 CCC Korea (12V Only) SGS (Brazil) FCC RCM

Model No. GT-46600-6012-T3

Part No./Ordering No. TR9CE5000LCP-N(R6B)

Rev I

#### Limitation of Use:

GlobTek product are not authorized for use as mission critical components in life support hazardous environment, nuclear or aircraft applications without prior written approval from the CEO of GlobTek Inc.

Contents of this document are subject to change without prior notice.

GlobTek, Inc.  
www.globtek.com  
186 Veterans Drive,  
Northvale, NJ 07647  
Tel. (201) 784-1000  
Fax (201) 784-0111

Drawing Title: GT-46600-6012-T3, ITE Power Supply, Efficiency Level: VI, Case Color/Style: GlobTek Black, Desktop/External, Regulated Switchmode AC-DC Power Supply AC Adaptor, Input Rating: 100-240V~, 50-60 Hz, IEC 60320/C14 , Output Rating: 60W, 12V@5A, Output Configuration: 1200 mm, 16/2 Cond, UL 2468, Female Barrel 5.5 \* 2.5 \* 11mm with internal Spring Clip and Locking Notch or Equal, Ferrite: Core Size: 14.2\*28.5\*8.2, GlobTek Black, GT Cord # C2286, Pin Out: Center Positive (+V), Blades/Input Cord: Not Applicable, Approvals: 230V CoC Tier 2 Saudi Malaysia Singapore Taiwan BSMI CB EAC EAC BIS South Africa NOM FCC IRAM CE CE China RoHS Class I Level VI LPS RoHS Ukraine VCCI WEEE cULus PSE PSE CAN ICES-3 CCC Korea (12V Only) SGS (Brazil) FCC RCM

Model No. GT-46600-6012-T3

Part No./Ordering No. TR9CE5000LCP-N(R6B)

Rev I

## POWER SUPPLY INFORMATION

TYPE: Desktop/External  
TECHNOLOGY: Regulated Switchmode AC-DC Power Supply AC Adaptor  
CASE COLOR: GlobTek Black  
NAMEPLATE RATED INPUT: 100-240V~, 50-60 Hz, 1.5A  
INPUT CONFIG: IEC 60320/C14  
WATTS: 60.0  
VOLTS OUT: 12  
CURRENT OUT (Amps): 5  
BLADE/CORD INCLUDED: N/A:  
BLADE/CORD INSTALLED: N/A:  
GROUNDING CONFIGURATION (E1) Earthed output  
EFFICIENCY LEVEL: VI  
OUTPUT CONFIGURATION 1200 mm, 16/2 Cond, UL 2468, Female Barrel 5.5 \* 2.5 \* 11mm with internal Spring Clip and Locking Notch or Equal, Ferrite: Core Size: 14.2\*28.5\*8.2, GlobTek Black, GT Cord # C2286  
CONNECTOR PIN OUT: Center Positive (+V)  
LABEL SPECS: Standard GT,L-1186  
PACK SPEC: PACKING FOR TR9CE5000LCP-N(R6B)

Notes/Modifications/Customizations (notes in this section supersede the values shown in the standard spec):

DIMENSIONS ARE IN MM UNLESS SPECIFIED OTHERWISE.

GloTek, Inc. www.globtek.com 186 Veterans Drive, Northvale, NJ 07647 Tel. (201) 784-1000 Fax (201) 784-0111	Drawing Title: GT-46600-6012-T3, ITE Power Supply, Efficiency Level: VI, Case Color/Style: GlobTek Black, Desktop/External, Regulated Switchmode AC-DC Power Supply AC Adaptor, Input Rating: 100-240V~, 50-60 Hz, IEC 60320/C14 , Output Rating: 60W, 12V@5A, Output Configuration: 1200 mm, 16/2 Cond, UL 2468, Female Barrel 5.5 * 2.5 * 11mm with internal Spring Clip and Locking Notch or Equal, Ferrite: Core Size: 14.2*28.5*8.2, GlobTek Black, GT Cord # C2286, Pin Out: Center Positive (+V), Blades/Input Cord: Not Applicable, Approvals: 230V CoC Tier 2 Saudi Malaysia Singapore Taiwan BSMI CB EAC EAC BIS South Africa NOM FCC IRAM CE CE China RoHS Class I Level VI LPS RoHS Ukraine VCCI WEEE cULus PSE PSE CAN ICES-3 CCC Korea (12V Only) SGS (Brazil) FCC RCM	
	Model No. GT-46600-6012-T3	
	Part No./Ordering No. TR9CE5000LCP-N(R6B)	Rev I

## ELECTRICAL SPECIFICATIONS

### A) ELECTRICAL SPECIFICATIONS:

01. Input Voltage: Specified 90-264 Vac, Nameplate rated: 100-240Vac
02. Input Frequency: Specified 47-63 Hz, Nameplate rated 50-60Hz
03. Input Rated Current: 1.5A RMS Max
04. Inrush Current: No damage at 240VAC Cold Start
05. Average Efficiency: 88% Min (CEC & DOE LEVEL VI Compliant); 89% Min (ErP Tier2 Compliant)
06. Input Power(no load): <0.21W (CEC &DOE Level VI Compliant); <0.15W (ErP Tier2 Compliant)
07. Output Regulation: +/- 5% measured at the output connector
08. Line regulation: ±1%
09. Ripple Voltage: 200mV (p-p) (100-240V AC Input). Measuring is done by 20MHz bandwidth oscilloscope and terminated each output with a 10uf aluminum electrolytic capacitor and 0.1uf ceramic capacitor.

### B) PROTECTION

01. Over-Voltage: Electronically Protected Zener clamp across the output
02. Short Circuit: Electronically Protected unit will auto recover upon removal of fault
03. Over Temperature Protection: There shall be no ignition or smoke and deformation of case
04. Over voltage protection: for 12V - 16V; for 15V - 20.25V, for 19V - 25.65, for 24V - 32.4V

### C) SAFETY

01. Dielectric Withstand Voltage: 4242Vdc from primary to secondary
02. Earth Leakage Current: <3.5 mA at 240Vac input voltage
03. Touch Current: <0.25mA @ 240Vac input voltage
04. ROHS 2: Complies with EU 2011/65/EU and China SJ/T 11363-2006
05. Earth continuity test:<0.1 Ohm or < 0.2 Ohm when with a non-detachable Power Supply cord, Class I Only

### D) OTHER:

01. MTBF: 200,000 Hours @ 25°C ambient temperature
02. Operating Temperature: 0°C to 40°C ambient temperature
03. Humidity: 10% to 90% relative humidity
04. Storage Temperature: -10°C to 70°C
05. Cooling: Convection
06. ROHS 2: Complies with EU 2011/65/EU and China SJ/T 11363-2006

### E) ENCLOSURE

01. Housing: High impact plastic, 94V0 polycarbonate, non-vented
02. Size: 121\*52\*33 +/-1.0 mm
03. Markings: Label and/or Pad Printed and/or Molded in the case

GlobTek, Inc.  
 www.globtek.com  
 186 Veterans Drive,  
 Northvale, NJ 07647  
 Tel. (201) 784-1000  
 Fax (201) 784-0111

Drawing Title: GT-46600-6012-T3, ITE Power Supply, Efficiency Level: VI, Case Color/Style: GlobTek Black, Desktop/External, Regulated Switchmode AC-DC Power Supply AC Adaptor, Input Rating: 100-240V~, 50-60 Hz, IEC 60320/C14, Output Rating: 60W, 12V@5A, Output Configuration: 1200 mm, 16/2 Cond, UL 2468, Female Barrel 5.5 \* 2.5 \* 11mm with internal Spring Clip and Locking Notch or Equal, Ferrite: Core Size: 14.2\*28.5\*8.2, GlobTek Black, GT Cord # C2286, Pin Out: Center Positive (+V), Blades/Input Cord: Not Applicable, Approvals: 230V CoC Tier 2 Saudi Malaysia Singapore Taiwan BSMI CB EAC EAC BIS South Africa NOM FCC IRAM CE CE China RoHS Class I Level VI LPS RoHS Ukraine VCCI WEEE cULus PSE PSE CAN ICES-3 CCC Korea (12V Only) SGS (Brazil) FCC RCM

Model No. GT-46600-6012-T3

Part No./Ordering No. TR9CE5000LCP-N(R6B)

Rev I

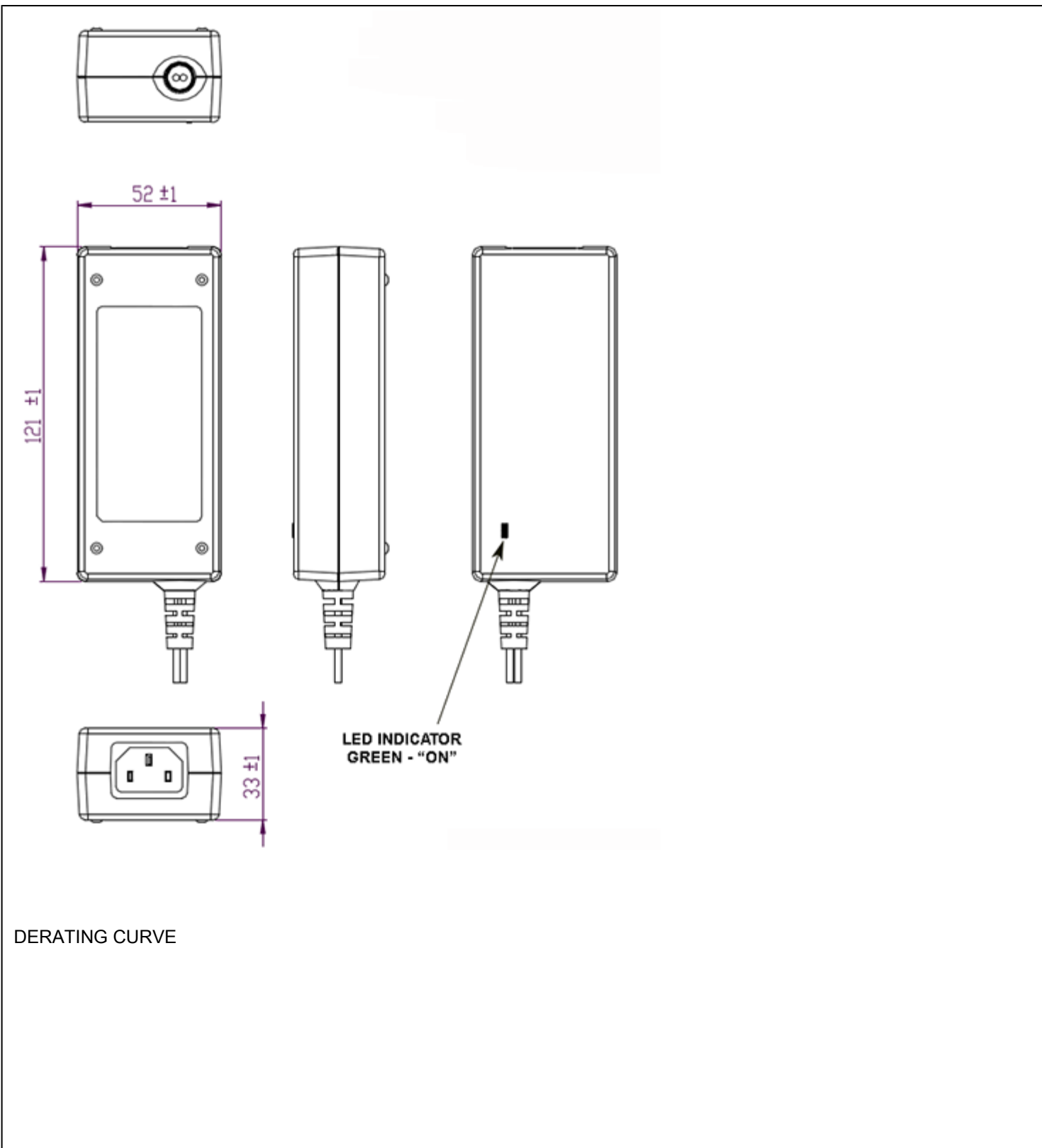

DERATING CURVE

GlobTek, Inc.  
 www.globtek.com  
 186 Veterans Drive,  
 Northvale, NJ 07647  
 Tel. (201) 784-1000  
 Fax (201) 784-0111

Drawing Title: GT-46600-6012-T3, ITE Power Supply, Efficiency Level: VI, Case Color/Style: GlobTek Black, Desktop/External, Regulated Switchmode AC-DC Power Supply AC Adaptor, Input Rating: 100-240V~, 50-60 Hz, IEC 60320/C14 , Output Rating: 60W, 12V@5A, Output Configuration: 1200 mm, 16/2 Cond, UL 2468, Female Barrel 5.5 \* 2.5 \* 11mm with internal Spring Clip and Locking Notch or Equal, Ferrite: Core Size: 14.2\*28.5\*8.2, GlobTek Black, GT Cord # C2286, Pin Out: Center Positive (+V), Blades/Input Cord: Not Applicable, Approvals: 230V CoC Tier 2 Saudi Malaysia Singapore Taiwan BSMI CB EAC EAC BIS South Africa NOM FCC IRAM CE CE China RoHS Class I Level VI LPS RoHS Ukraine VCCI WEEE cULus PSE PSE CAN ICES-3 CCC Korea (12V Only) SGS (Brazil) FCC RCM

Model No. GT-46600-6012-T3

Part No./Ordering No. TR9CE5000LCP-N(R6B)

Rev I

### Typical External Power Supply Derating Curve

(For Efficiency Level V and Efficiency Level VI Products)

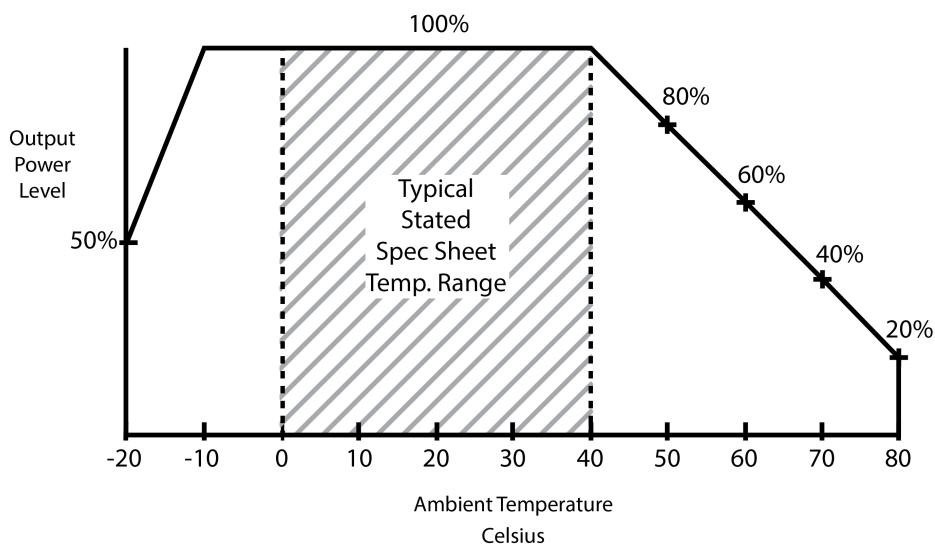

GlobTek, Inc.  
 www.globtek.com  
 186 Veterans Drive,  
 Northvale, NJ 07647  
 Tel. (201) 784-1000  
 Fax (201) 784-0111

Drawing Title: GT-46600-6012-T3, ITE Power Supply, Efficiency Level: VI, Case Color/Style: GlobTek Black, Desktop/External, Regulated Switchmode AC-DC Power Supply AC Adaptor, Input Rating: 100-240V~, 50-60 Hz, IEC 60320/C14 , Output Rating: 60W, 12V@5A, Output Configuration: 1200 mm, 16/2 Cond, UL 2468, Female Barrel 5.5 \* 2.5 \* 11mm with internal Spring Clip and Locking Notch or Equal, Ferrite: Core Size: 14.2\*28.5\*8.2, GlobTek Black, GT Cord # C2286, Pin Out: Center Positive (+V), Blades/Input Cord: Not Applicable, Approvals: 230V CoC Tier 2 Saudi Malaysia Singapore Taiwan BSMI CB EAC EAC BIS South Africa NOM FCC IRAM CE CE China RoHS Class I Level VI LPS RoHS Ukraine VCCI WEEE cULus PSE PSE CAN ICES-3 CCC Korea (12V Only) SGS (Brazil) FCC RCM

Model No. GT-46600-6012-T3

Part No./Ordering No. TR9CE5000LCP-N(R6B)

Rev I

## INPUT CONFIGURATION

Grounding Configuration:

Blades/Cord Included: N/A:

Blades/Cord Installed: N/A:

IEC 60320/C14 AC Inlet Connector, Class I, Earth Ground

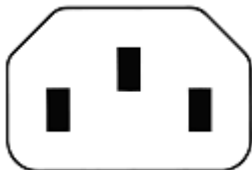

Mates with IEC 60320/C13 Plug

Optional Locking IEC60320 Receptacle and cord option available on some models by request.:



### [Standard International IEC 320/C13 Cordsets](#)

Below are standard cordsets which are "not included" (unless stated above); these can be purchased separately or packaged with the power supply. Contact your Sales Engineer if the style required is not shown below. Many more available in different lengths, colors or cable material.

## Stock Power Supply Cords

Part Number/ Link	Country	Plug	Termination	Length (mm)	(Ft)
3 Conductors (Grounded) IEC 320/C13					
<a href="#">3021457F701(R)</a>	N. American	NEMA 5-15P	IEC 320/C13	2150	7
<a href="#">1191068F0701(R)</a>	N. American	NEMA 5-15P Hospital	IEC 320/C13	2459	8
<a href="#">2194272M5701-T(R)</a>	Argentina	IRAM 2073	IEC 320/C13	2500	8
<a href="#">5502022M5701A(R)</a>	Australian	AS3112 / 3 PRONG	IEC 320/C13	2500	8
<a href="#">204B4272M5701(R)</a>	Brazil	BRAZILIAN; WS-002	IEC 320/C13	2500	8

PROPRIETARY INFORMATION

PROPRIETARY OF GLOBTEK, INC. ANY REPRODUCTION, DISCLOSURE OR USE OF THIS DRAWING, IN WHOLE OR IN PART, IS HEREBY PROHIBITED EXCEPT AS SPECIFIED IN WRITING BY GLOBTEK, INC.

GlobTek, Inc. www.globtek.com 186 Veterans Drive, Northvale, NJ 07647 Tel. (201) 784-1000 Fax (201) 784-0111	Drawing Title: GT-46600-6012-T3, ITE Power Supply, Efficiency Level: VI, Case Color/Style: GlobTek Black, Desktop/External, Regulated Switchmode AC-DC Power Supply AC Adaptor, Input Rating: 100-240V~, 50-60 Hz, IEC 60320/C14 , Output Rating: 60W, 12V@5A, Output Configuration: 1200 mm, 16/2 Cond, UL 2468, Female Barrel 5.5 * 2.5 * 11mm with internal Spring Clip and Locking Notch or Equal, Ferrite: Core Size: 14.2*28.5*8.2, GlobTek Black, GT Cord # C2286, Pin Out: Center Positive (+V), Blades/Input Cord: Not Applicable, Approvals: 230V CoC Tier 2 Saudi Malaysia Singapore Taiwan BSMI CB EAC EAC BIS South Africa NOM FCC IRAM CE CE China RoHS Class I Level VI LPS RoHS Ukraine VCCI WEEE cULus PSE PSE CAN ICES-3 CCC Korea (12V Only) SGS (Brazil) FCC RCM	
	Model No. GT-46600-6012-T3	
	Part No./Ordering No. TR9CE5000LCP-N(R6B)	Rev I

<a href="#">6023602M5701(R)</a>	China	CCC GR2099	IEC 320/C13	2500	8
<a href="#">G8014272M5701(R)</a>	Danish	AFSNIT SECTION 107-2-D1	IEC 320/C13	2500	8
<a href="#">23144272M5701-T(R)</a>	Europe	CEE 7/7	IEC 320/C13	2500	8
2084272M5701(R)	India	India IS 1293 (also known as IA16A3 or BS546)	IEC 320/C13	2500	8
<a href="#">377C4272M5701(R)</a>	Israel	ISL 377C	IEC 320/C13	2500	8
<a href="#">23024272M5701(R)</a>	Italy	CEI 23-16/VII	IEC 320/C13	2500	8
<a href="#">3003339F701(R)</a> [3x1.25mm2] <a href="#">3003068F2701-HK(R)</a> [3 x 2.0mm2]	Japan	JIS 8303 / 3 PINS	IEC 320/C13	2500	8
<a href="#">2313K3432M5701(R)</a>	Korea	KS C 8305	IEC 320/C13	2500	8
23144272M5701-T(R) [Same as Europe Above]	Russia	GOST 7396	IEC 320/C13	2500	8
<a href="#">2084272M5701(R)</a>	S. Africa	S. African	IEC 320/C13	2500	8
<a href="#">23214272M5701(R)</a>	Switzerland	SEV 1011 ( EL 203)	IEC 320/C13	2500	8
<a href="#">3003322M5701(R)</a>	Taiwan	BSMI	IEC 320/C13	2500	8
<a href="#">PZ0800100-2M5BK13H(R)</a>	UK	BS 1363A	IEC 320/C13	2500	8
<a href="#">7055002M5701A(R)</a>	International	IEC 320 C14-C13	IEC 320/C13	2500	8



GlobTek, Inc.  
 www.globtek.com  
 186 Veterans Drive,  
 Northvale, NJ 07647  
 Tel. (201) 784-1000  
 Fax (201) 784-0111

Drawing Title: GT-46600-6012-T3, ITE Power Supply, Efficiency Level: VI, Case Color/Style: GlobTek Black, Desktop/External, Regulated Switchmode AC-DC Power Supply AC Adaptor, Input Rating: 100-240V~, 50-60 Hz, IEC 60320/C14, Output Rating: 60W, 12V@5A, Output Configuration: 1200 mm, 16/2 Cond, UL 2468, Female Barrel 5.5 \* 2.5 \* 11mm with internal Spring Clip and Locking Notch or Equal, Ferrite: Core Size: 14.2\*28.5\*8.2, GlobTek Black, GT Cord # C2286, Pin Out: Center Positive (+V), Blades/Input Cord: Not Applicable, Approvals: 230V CoC Tier 2 Saudi Malaysia Singapore Taiwan BSMI CB EAC EAC BIS South Africa NOM FCC IRAM CE CE China RoHS Class I Level VI LPS RoHS Ukraine VCCI WEEE cULus PSE PSE CAN ICES-3 CCC Korea (12V Only) SGS (Brazil) FCC RCM

Model No. GT-46600-6012-T3

Part No./Ordering No. TR9CE5000LCP-N(R6B)

Rev I

**OUTPUT CORD AND CONNECTOR: LCL/C2286**

ACTUAL CONNECTORS, OVERMOLDS, FERRITES MAY VARY SLIGHTLY FROM THE PICTURE BELOW

CABLE TYPE	UL 2468
CABLE LENGTH (mm)	1200
CABLE TOLERANCE (mm)	±100
WIRE GAUGE (AWG)	16
CONDUCTORS	2
HANK DIMENSION (mm)	95 ± 10
CABLE / CONNECTOR OVERMOLD COLOR	GlobTek Black
FERRITE TYPE / DIMENSION	Core Size: 14.2*28.5*8.2
FERRITE # OF TURNS ( <a href="#">Definition</a> )	2 Pass thru core (1 turns)
FERRITE DIMENSION FROM STRAIN RELIEF	N/A
FERRITE DIMENSION FROM PLUG	150 ± 10
PLUG TYPE	Female Barrel 5.5 * 2.5 * 11mm with internal Spring Clip and Locking Notch or Equal
OVER MOLD ORIENTATION	Straight
CONNECTOR PIN OUT:	Center Positive (+V)
ADDITIONAL REQUIREMENTS	

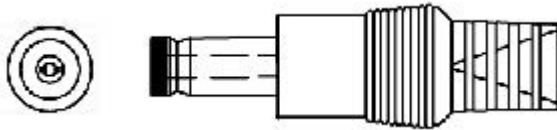

ADDITIONAL OUTPUT PLUG OPTIONS ARE AVAILABLE AT <http://www.globtek.com/connectors/>  
 STANDARD PLUGS AND CONNECTORS CAN BE SEEN ONLINE AT <http://www.globtek.com/connectors/>

GlobTek, Inc.  
 www.globtek.com  
 186 Veterans Drive,  
 Northvale, NJ 07647  
 Tel. (201) 784-1000  
 Fax (201) 784-0111

Drawing Title: GT-46600-6012-T3, ITE Power Supply, Efficiency Level: VI, Case Color/Style: GlobTek Black, Desktop/External, Regulated Switchmode AC-DC Power Supply AC Adaptor, Input Rating: 100-240V~, 50-60 Hz, IEC 60320/C14, Output Rating: 60W, 12V@5A, Output Configuration: 1200 mm, 16/2 Cond, UL 2468, Female Barrel 5.5 \* 2.5 \* 11mm with internal Spring Clip and Locking Notch or Equal, Ferrite: Core Size: 14.2\*28.5\*8.2, GlobTek Black, GT Cord # C2286, Pin Out: Center Positive (+V), Blades/Input Cord: Not Applicable, Approvals: 230V CoC Tier 2 Saudi Malaysia Singapore Taiwan BSMI CB EAC EAC BIS South Africa NOM FCC IRAM CE CE China RoHS Class I Level VI LPS RoHS Ukraine VCCI WEEE cULus PSE PSE CAN ICES-3 CCC Korea (12V Only) SGS (Brazil) FCC RCM

Model No. GT-46600-6012-T3

Part No./Ordering No. TR9CE5000LCP-N(R6B)

Rev I

**LABEL:L-1186**

LABEL P/N: Standard GT  
 MATERIAL: Flat Thermal Transfer, Imprintable, Polyester Label and/or Pad Printed and/or Molded, and/or Laser Engraved in the case  
 BACKGROUND COLOR: Black if housing is Black, White or Silver if housing is White or Gray.  
 TEXT COLOR: White or Silver if label is Black Background for Black housing. Black if label is White or Silver background and Housing is White or Gray  
 LABEL WIDTH (mm): 37.3  
 LABEL HEIGHT (mm): 77.3

Below is the minimum information which will appear on the label. NOTE: in the logo area additional/actual positioning of symbols and text is subjected to change as per agency updates/requirements or additional model approvals become available. Regulatory certifications/label markings may be in logo area on the label or molded into the case housing outside the label area. Information will be shown via label and/or pad printed and/or molded and/or laser engraved in the case. \* Date code markings at GlobTek option.

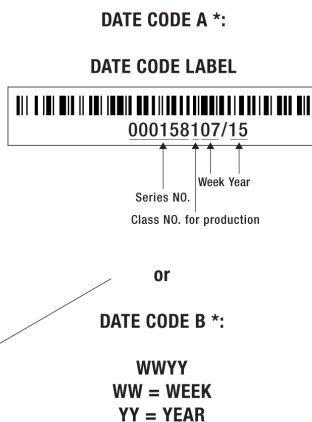

A=ITE Power Supply  
 B=P/N: (料号) TR9CE5000LCP-N(R6B)  
 C=Model (型号) GT-46600-6012-T3  
 D=Input (输入) 100-240V~, 50-60 Hz, 1.5A  
 E=Output (输出) 12 V 5 A ,60.0W

AGENCY ONLINE DOCUMENTS <http://www.globtek.info/certs/GT-46600-60VV-X.X/>  
 CE EC-Declaration for Medical [Contact GlobTek for more information](#)  
 CE EC-Declaration for Industrial/Commercial/ITE [http://www.globtek.com/pdf/ec\\_declaration/a00a000000Mia64EAB](http://www.globtek.com/pdf/ec_declaration/a00a000000Mia64EAB)  
 RoHS/RoHS2 Declaration [http://www.globtek.com/pdf/rohs\\_cert/01ta0000005d2s9AAA](http://www.globtek.com/pdf/rohs_cert/01ta0000005d2s9AAA)  
 REACH Declaration [http://www.globtek.com/pdf/iso\\_certificates/REACH.pdf](http://www.globtek.com/pdf/iso_certificates/REACH.pdf)

GlobTek, Inc.  
www.globtek.com  
186 Veterans Drive,  
Northvale, NJ 07647  
Tel. (201) 784-1000  
Fax (201) 784-0111

Drawing Title: GT-46600-6012-T3, ITE Power Supply, Efficiency Level: VI, Case Color/Style: GlobTek Black, Desktop/External, Regulated Switchmode AC-DC Power Supply AC Adaptor, Input Rating: 100-240V~, 50-60 Hz, IEC 60320/C14 , Output Rating: 60W, 12V@5A, Output Configuration: 1200 mm, 16/2 Cond, UL 2468, Female Barrel 5.5 \* 2.5 \* 11mm with internal Spring Clip and Locking Notch or Equal, Ferrite: Core Size: 14.2\*28.5\*8.2, GlobTek Black, GT Cord # C2286, Pin Out: Center Positive (+V), Blades/Input Cord: Not Applicable, Approvals: 230V CoC Tier 2 Saudi Malaysia Singapore Taiwan BSMI CB EAC EAC BIS South Africa NOM FCC IRAM CE CE China RoHS Class I Level VI LPS RoHS Ukraine VCCI WEEE cULus PSE PSE CAN ICES-3 CCC Korea (12V Only) SGS (Brazil) FCC RCM

Model No. GT-46600-6012-T3

Part No./Ordering No. TR9CE5000LCP-N(R6B)

Rev I

Conflict Minerals Declaration

<http://www.globtek.com/pdf/conflict-minerals.pdf>

IPXY rating is based on 3rd party testing and customers should check suitability and test system level IPXY rating before ordering.

## Regulatory Certifications/Label Markings

LATEST PRODUCT/MODEL CERTIFICATIONS: <http://en.globtek.com/datasheet/id/a00a000000Mia64>

AGENCY ONLINE DOCUMENTS: <http://www.globtek.info/certs/GT-46600-60VV-X.X/>

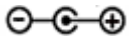

Center Positive (+V)

GlobTek, Inc.  
 www.globtek.com  
 186 Veterans Drive,  
 Northvale, NJ 07647  
 Tel. (201) 784-1000  
 Fax (201) 784-0111

Drawing Title: GT-46600-6012-T3, ITE Power Supply, Efficiency Level: VI, Case Color/Style: GlobTek Black, Desktop/External, Regulated Switchmode AC-DC Power Supply AC Adaptor, Input Rating: 100-240V~, 50-60 Hz, IEC 60320/C14 , Output Rating: 60W, 12V@5A, Output Configuration: 1200 mm, 16/2 Cond, UL 2468, Female Barrel 5.5 \* 2.5 \* 11mm with internal Spring Clip and Locking Notch or Equal, Ferrite: Core Size: 14.2\*28.5\*8.2, GlobTek Black, GT Cord # C2286, Pin Out: Center Positive (+V), Blades/Input Cord: Not Applicable, Approvals: 230V CoC Tier 2 Saudi Malaysia Singapore Taiwan BSMI CB EAC EAC BIS South Africa NOM FCC IRAM CE CE China RoHS Class I Level VI LPS RoHS Ukraine VCCI WEEE cULus PSE PSE CAN ICES-3 CCC Korea (12V Only) SGS (Brazil) FCC RCM

Model No. GT-46600-6012-T3

Part No./Ordering No. TR9CE5000LCP-N(R6B)

Rev I

## PACKAGING

Packing Spec P/N: PACKING FOR  
 TR9CE5000LCP-N(R6B)

Box Qty: 45

Gift Box Size (mm): Egg Crate

Gift Box Color: None

Master Carton Size (mm): 520\*370\*205

Master GW (Kg): 15.6 kg

BLADES INCLUDED: N/A:

BLADE/CORD INSTALLED: N/A:

If specific packaging is required, this section must specify all requirements and note "no exceptions". If this section does not specify packaging, it is subject to change without notice at GlobTek's discretion

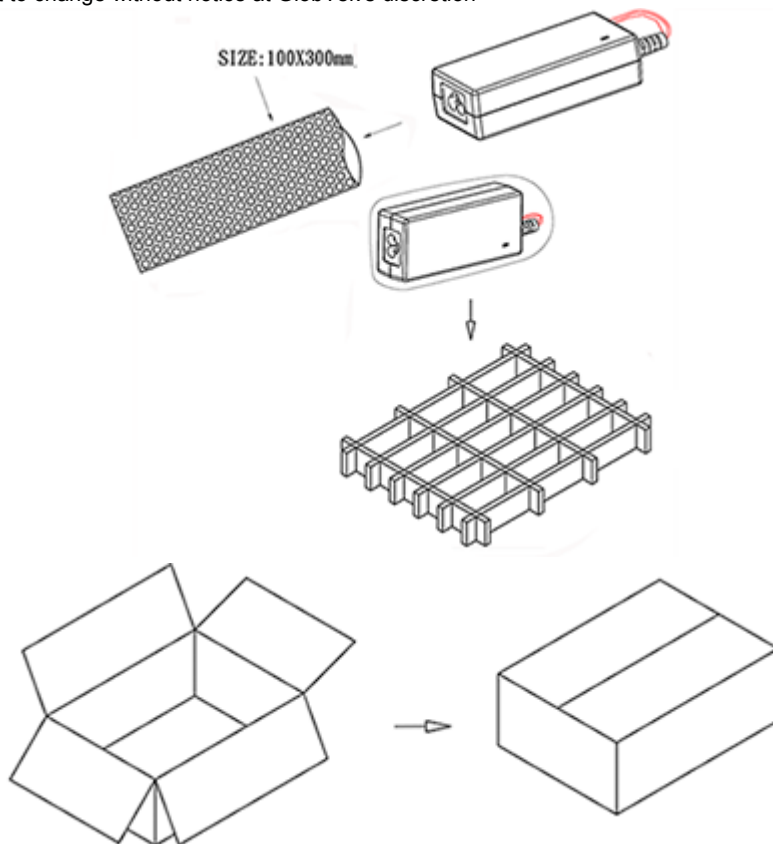

GlobTek, Inc.  
www.globtek.com  
186 Veterans Drive,  
Northvale, NJ 07647  
Tel. (201) 784-1000  
Fax (201) 784-0111

Drawing Title: GT-46600-6012-T3, ITE Power Supply, Efficiency Level: VI, Case Color/Style: GlobTek Black, Desktop/External, Regulated Switchmode AC-DC Power Supply AC Adaptor, Input Rating: 100-240V~, 50-60 Hz, IEC 60320/C14 , Output Rating: 60W, 12V@5A, Output Configuration: 1200 mm, 16/2 Cond, UL 2468, Female Barrel 5.5 \* 2.5 \* 11mm with internal Spring Clip and Locking Notch or Equal, Ferrite: Core Size: 14.2\*28.5\*8.2, GlobTek Black, GT Cord # C2286, Pin Out: Center Positive (+V), Blades/Input Cord: Not Applicable, Approvals: 230V CoC Tier 2 Saudi Malaysia Singapore Taiwan BSMI CB EAC EAC BIS South Africa NOM FCC IRAM CE CE China RoHS Class I Level VI LPS RoHS Ukraine VCCI WEEE cULus PSE PSE CAN ICES-3 CCC Korea (12V Only) SGS (Brazil) FCC RCM

Model No. GT-46600-6012-T3

Part No./Ordering No. TR9CE5000LCP-N(R6B)

Rev I

## INSTRUCTION SHEET

N/A