





NOTE [注記]

1. TAB PULLING STRENGTH OVER 29.4N  
[端子溶接強度：29.4N以上]
2. TAB MATERIAL: STAINLESS STEEL WITH TIN PLATING   
[端子材料：基材 ステンレス/表面 部分Snメッキ 
3. ( ) : REFERENCE DIMENSION AND ANGLE  
[ ( ) 寸法、角度は参考値]

PRODUCT NO.	BR-2/3AE2PN	SCALE	
		2:1	
DRAWING NO.	PC-B23A0441	REV.	
		0	

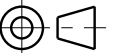
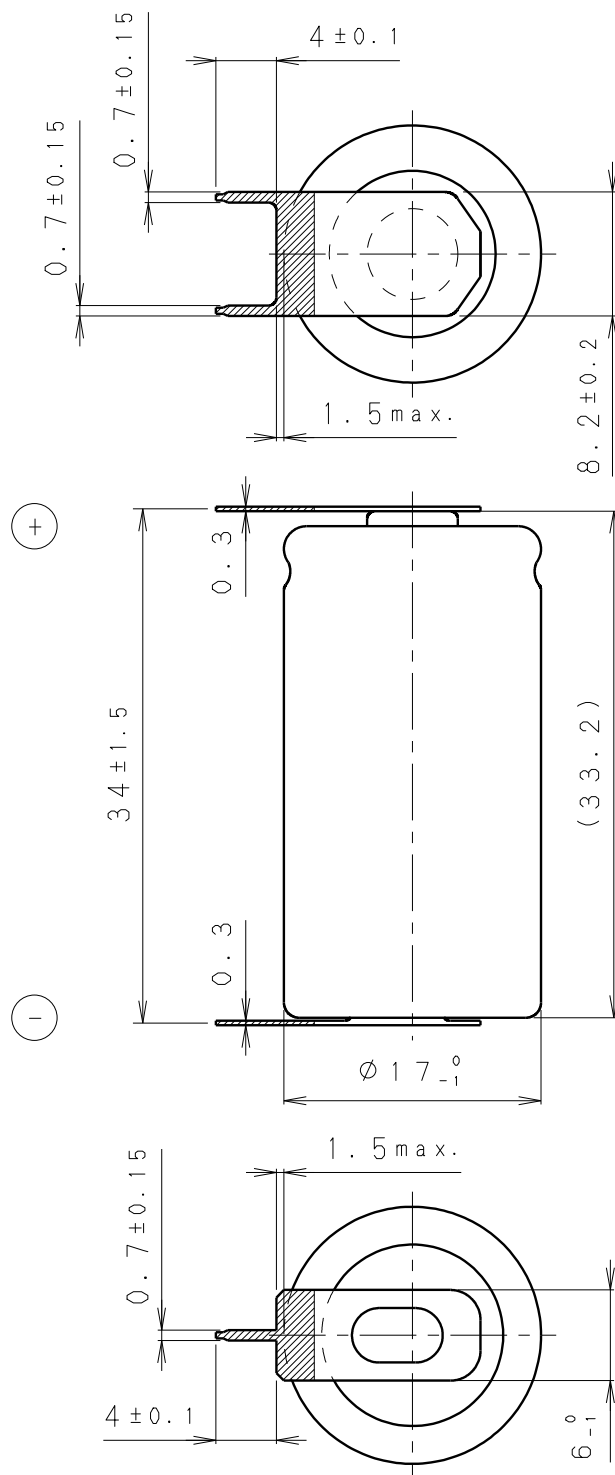

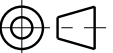

\* Note [注記]

1. Tab pulling Strength Over 30N  
[端子溶接強度: 30N以上]
2. Tab Material: Stainless Steel with Tin plating   
[端子材料: 基材 ステンレス/表面 部分Snメッキ 
3. ( ): Reference dimension and angle  
[ ( ) 寸法、角度は参考値]

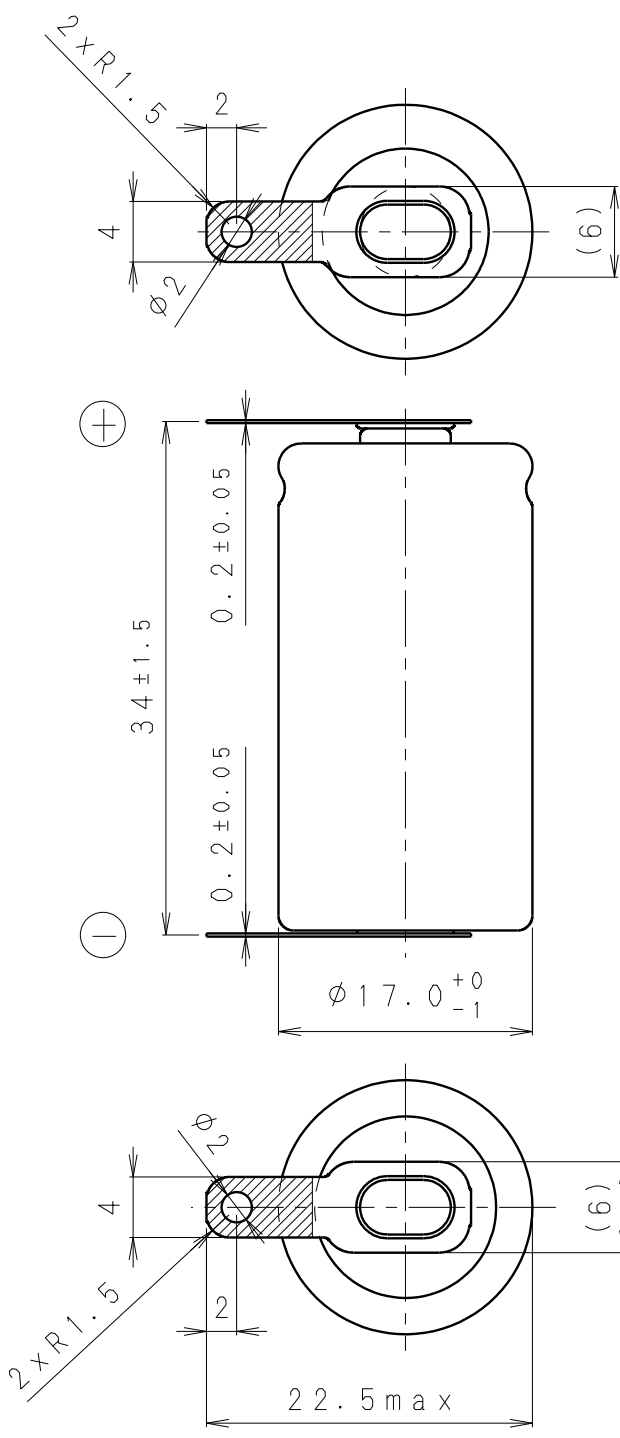
Product No.	CR-2/3AZE2PN	Scale	
		2:1	
Drawing No.	PC-C23AZ0434	Rev.	
		0	



\* Note [注記]

1. Tab pulling Strength Over 9.8N  
[端子溶接強度: 9.8N以上]
2. Tab Material: Stainless Steel with Tin plating   
[端子材料: 基材 ステンレス/表面 部分Snメッキ 
3. ( ): Reference dimension and angle  
[ ( ) 寸法、角度は参考値]

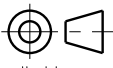
Product No.	CR-2/3AZT5PN	Scale	
		2:1	
Drawing No.	PC-C23AZ0447	Rev.	
		1	

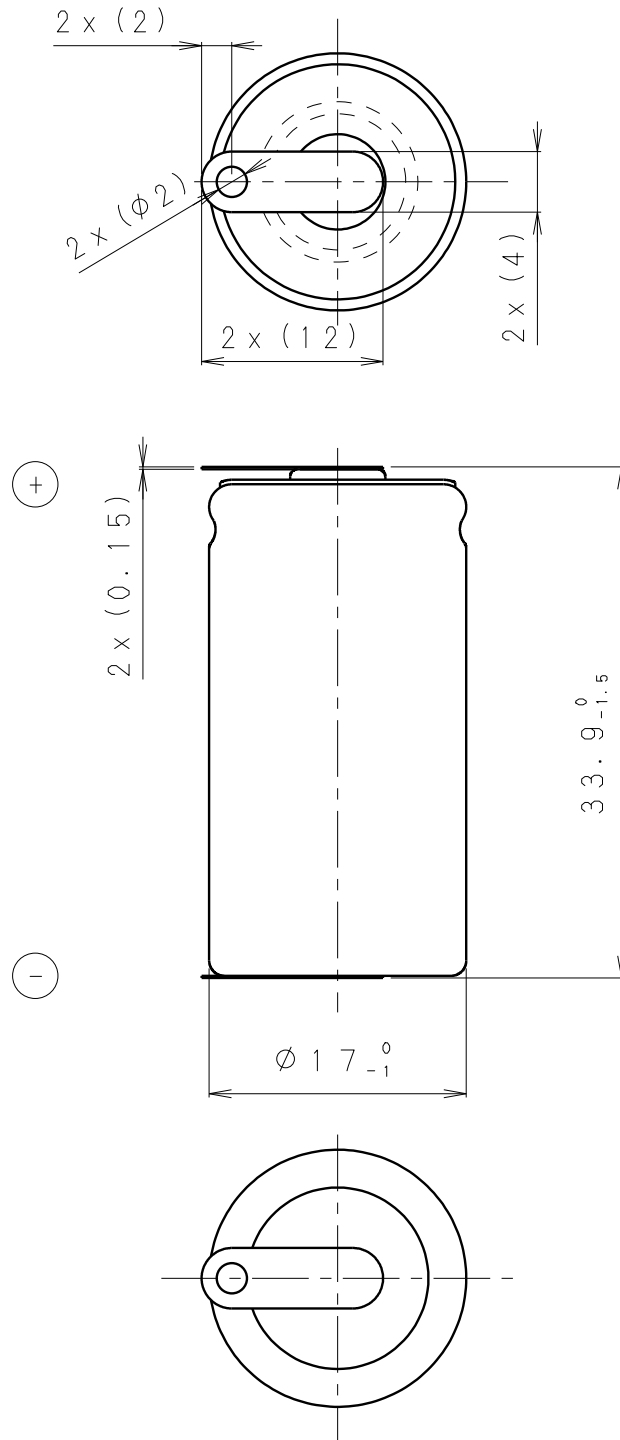

\* Note [注記]

1. Tab pulling Strength Over 9.8N  
[端子溶接強度: 9.8N以上]
2. Tab Material: Nickel or Nickel plating steel  
[端子材料: 基材 ニッケルもしくはニッケルメッキ鋼板]
3. ( ): Reference dimension and angle  
[( ) 寸法、角度は参考値]

PRODUCT NO.	BR-2/3AT2SPN	SCALE	
		2:1	
DRAWING NO.	PC-B23A0104	REV.	
		0	