

0.5 Nm ovoid 1.4 and 3.2 Watts 1.4 W Part number made to order



- Gearbox 0.5 Nm
- Motor power max. 3.2 W
- Class A EMC interference suppression (radiated)
- Compatible with 6 V, 9 V or 12 V battery power supply
- Optional class B interference suppression
- Optional 1, 5, 12 or 48 pulses/rev encoder

Part numbers

	Type	Type	Voltage	Output speed (rpm)	Ratios (i)
82714013	1.4 W	827140	24 V	40	250/3

Specifications

General characteristics

Motor	82710002
Gearbox	810210
Maximum permitted torque from gearmotor under continuous conditions for 1 million turns (Nm)	0,5
Axial load static (daN)	1
Radial load static (daN)	8
Max. output power (W)	1,4
Nominal output (W)	1
Gearbox case temperature rise (°C)	40
Weight (g)	120

Made to order products, available on request

For more than 1000 pieces

- 48 pulses/rev encoder
- Class B filter
- Case N°2 (for other fixing points see diagram)
- Gearbox shaft
- Bearings for heavy radial loads
- Connections
- Reinforced gears
- For other types please consult Crouzet

Dimensions (mm)

827140

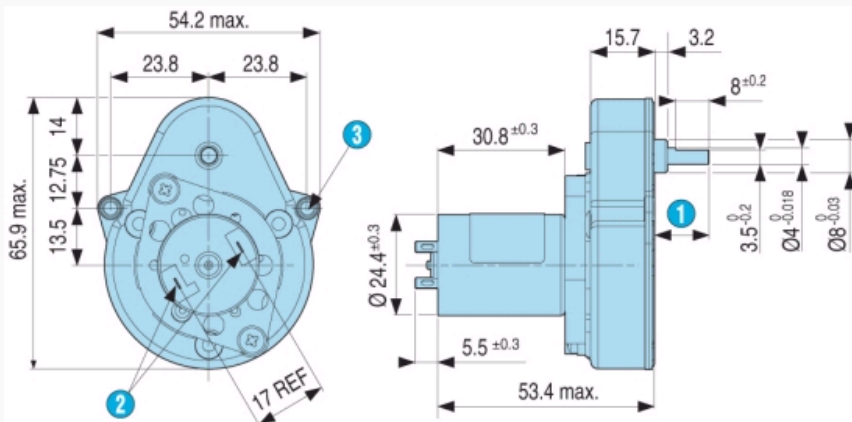

N°	Legend
1	13.2 mm max. shaft pushed-in
2	2 solder tags 2.8 x 0.5 mm
3	2 fixing holes Ø 3.2 mm

Dimensions (mm)

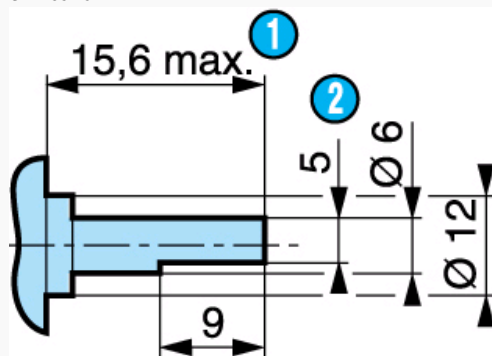
Shaft 70999421
SP1295.10

N°	Legend
1	Shaft pushed-in
2	5 across flats

Dimensions (mm)

Shaft 79200779

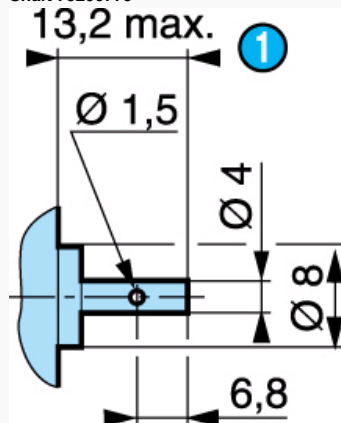

N°	Legend
1	Shaft pushed-in

Dimensions (mm)

Shaft 79200967

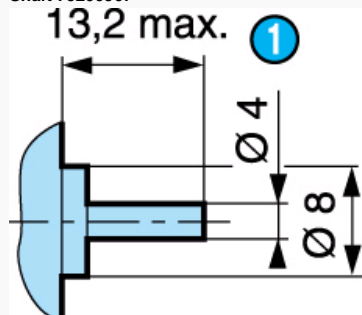

N°	Legend
1	Shaft pushed-in

Curves

Curve : torque/nominal speed 827140 (24 V)

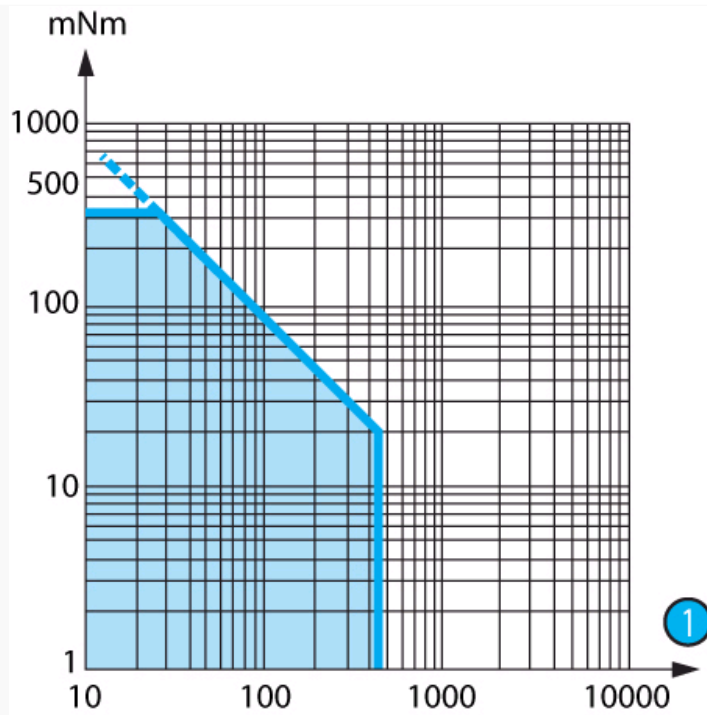

N°	Legend
1	rpm

Product adaptations



- Special supply voltage
- Lead output
- Special connectors
- Special shaft
- Special reduction ratio
- Special materials for gears
- Special ball bearings
- Special adaptor plate
- Class B EMC filter
- Friction
- Y system
- Greasing at low temperature
- Different number of pulses