



## MAX6969 Evaluation Kit

### General Description

The MAX6969 evaluation kit (EV kit) is an assembled and tested printed-circuit board (PCB) that demonstrates the MAX6969 16-port, 5.5V constant-current LED driver. Windows® 2000/XP/Vista-compatible software provides a handy user interface to exercise the features of the MAX6969.

### Features

- ◆ Windows 2000/XP/Vista (32-Bit)-Compatible Software
- ◆ Proven PCB Layout
- ◆ Complete Evaluation System
- ◆ Three Daisy-Chain Devices
- ◆ Six 7-Segment Displays
- ◆ Fully Assembled and Tested

### Ordering Information

PART	TYPE
MAX6969EVKIT+	EV kit

+Denotes lead-free and RoHS-compliant.

### Component List

DESIGNATION	QTY	DESCRIPTION
C1–C4, C6–C9, C12, C17, C18, C37	12	0.1µF ±10%, 16V X7R ceramic capacitors (0603) TDK C1608X7R1C104K Taiyo Yuden EMK107BJ104KA Murata GRM188R71C104K
C5	1	4.7µF ±20%, 50V (min) X7R ceramic capacitor (2220) Murata GRM55ER72A475K TDK C5750X7R1H475M
C10, C39	2	1µF ±10%, 16V X5R ceramic capacitors (0603) TDK C1608X5R1C105K Murata GRM188R61C105K AVX 0603YD105MAT KEMET C0603C105K4PAC
C11, C38, C40	3	10µF ±20%, 16V X5R ceramic capacitors (1206) Murata GRM31CR61C106M or TDK C3216X5R1C106M Panasonic ECJ3YB1C106M KEMET C1206C106M4PAC
C13	1	33nF ±10%, 16V (min) X5R ceramic capacitor (0603) Taiyo Yuden EMK107BJ333KA Murata GRM188R71E333K TDK C1608X7R1E333K

DESIGNATION	QTY	DESCRIPTION
C15, C16	2	10pF ±5%, 50V C0G ceramic capacitors (0603) Murata GRM1885C1H100J or TDK C1608C0G1H100J Taiyo Yuden UMK107CG100DZ
C30, C31	2	22pF ±5%, 50V C0G ceramic capacitors (0603) Murata GRM1885C1H220J or TDK C1608C0G1H220J Taiyo Yuden UMK107CG220KZ
J1	1	USB series B right-angle PC-mount receptacle
J2	0	2 x 4 dual-row vertical header pin
J3	0	Not installed, 2 x 5-pin JTAG header
JU1, JU3, JU4, JU5	0	Not installed, 3-pin headers—PCB short trace
JU2	0	Not installed, 2-pin header—PCB short trace
L1	1	Ferrite bead (0603) TDK MMZ1608R301A Murata BLM18SG700 TN1
LED1, LED2, LED3	3	Dual-digit, 0.56in 7-segment displays Lumex LDD-A514RI

Windows is a registered trademark of Microsoft Corp.



Maxim Integrated Products 1

For pricing, delivery, and ordering information, please contact Maxim Direct at 1-888-629-4642, or visit Maxim's website at [www.maxim-ic.com](http://www.maxim-ic.com).

Evaluates: MAX6969

# MAX6969 Evaluation Kit

## Component List (continued)

DESIGNATION	QTY	DESCRIPTION
LED4	1	Red LED (T1-3/4)
R1, R2, R3	3	2k $\Omega$ $\pm$ 1% resistors (0603)
R4	1	470 $\Omega$ $\pm$ 5% resistor (0603)
R5	1	2.2k $\Omega$ $\pm$ 5% resistor (0603)
R6	1	10k $\Omega$ $\pm$ 5% resistor (0603)
R7, R8	2	27 $\Omega$ $\pm$ 5% resistors (0603)
R9	1	1.5k $\Omega$ $\pm$ 5% resistor (0603)
R17	1	330 $\Omega$ $\pm$ 5% resistor (0603)
R19–R23	0	Not installed
U1, U2, U3	3	Maxim 16-port, 5.5V constant-current LED drivers MAX6969AUG+ (24-pin TSSOP)
U4	1	Maxim RISC microcontroller (68-pin QFN-EP, 10mm x 10mm) MAXQ2000-RAX+

DESIGNATION	QTY	DESCRIPTION
U5	1	USB UART FTDI FT232BL (32-pin TQFP, 7mm x 7mm)
U6	1	3-wire EEPROM Atmel AT93C46A
U7	1	Maxim LDO regulator (5-pin SO70) MAX8511EXK33+ (Top Mark: AEI)
U8	1	Maxim LDO regulator (5-pin SO70) MAX8511EXK25+ (Top Mark: ADV)
Y2	1	16MHz crystal
Y3	0	Not installed
Y4	1	6MHz crystal
—	1	PCB: MAX6969 Evaluation Kit+
—	1	USB A-to-B cable

## Component Suppliers

SUPPLIER	PHONE	WEBSITE
AVX Corp.	843-946-0238	www.avxcorp.com
Murata Mfg. Co., Ltd.	770-436-1300	www.murata.com
Panasonic Corp.	714-373-7366	www.panasonic.com
Taiyo Yuden	800-348-2496	www.t-yuden.com
TDK Corp.	847-803-6100	www.component.tdk.com

**Note:** Indicate that you are using the MAX6969 when contacting these component suppliers.

# MAX6969 Evaluation Kit

Evaluates: MAX6969

## Quick Start

### Required Equipment

Before beginning, the following equipment is needed:

- Maxim MAX6969 EV kit (includes USB type A-to-B cable)
- User-supplied Windows 2000/XP/Vista-compatible computer with a spare USB port

**Note:** In the following sections, software-related items are identified by bolding. Text in **bold** refers to items directly from the EV kit software. Text in **bold and underlined** refers to items from the Windows operating system.

### Procedure

The MAX6969 EV kit is fully assembled and tested. Follow the steps below to verify board operation:

- 1) Visit [www.maxim-ic.com/evkitsoftware](http://www.maxim-ic.com/evkitsoftware) to download the latest version of the EV kit software, 6969Rxx.zip. Save the EV kit software to a temporary folder and uncompress the zip file.
- 2) Install the EV kit software on your computer by launching the 6969Rxx.msi program inside the zip file. The program files are copied and icons are created in the Windows **Start | Programs** menu.
- 3) Ensure that the jumper settings are in the default positions, as shown in Table 1.
- 4) Connect the USB cable from the PC to the MAX6969 EV kit board. A **Building Driver Database** window pops up in addition to a **New Hardware Found** message when installing the USB driver for the first time. If you do not see a window that is similar to the one described above after 30s, remove the USB cable from the board and reconnect it. Administrator privileges are required to install the USB device driver on Windows 2000/XP/Vista.
- 5) Follow the directions of the **Add New Hardware Wizard** to install the USB device driver. Choose the **Search for the best driver for your device** option. Specify the location of the device driver to be **C:\Program Files\Maxim MAX6969EVKIT** (default installation directory) using the **Browse** button. During device driver installation, Windows XP shows a warning message indicating that the device driver Maxim uses does not contain a digital signature. This is not an error condition. It is safe to proceed with the installation. Refer to the USB\_Driver\_Help.PDF document for additional information
- 6) Verify that the EV kit's LED4 is lit, indicating that the USB is connected and providing power.
- 7) Start the EV kit software by clicking its icon in the Windows **Start** menu.
- 8) The software should automatically connect to the board after a few seconds.
- 9) In the **Demonstration Mode** group box, click on the **Counter demonstration** radio button. The 7-segment LED display will count in decimal, as shown in Figure 1.
- 10) In the **Demonstration Mode** group box, click on the **PC Time demonstration** radio button. The 7-segment LED will show the 24-hour time in hours, minutes, and seconds, as shown in Figure 2.

# MAX6969 Evaluation Kit

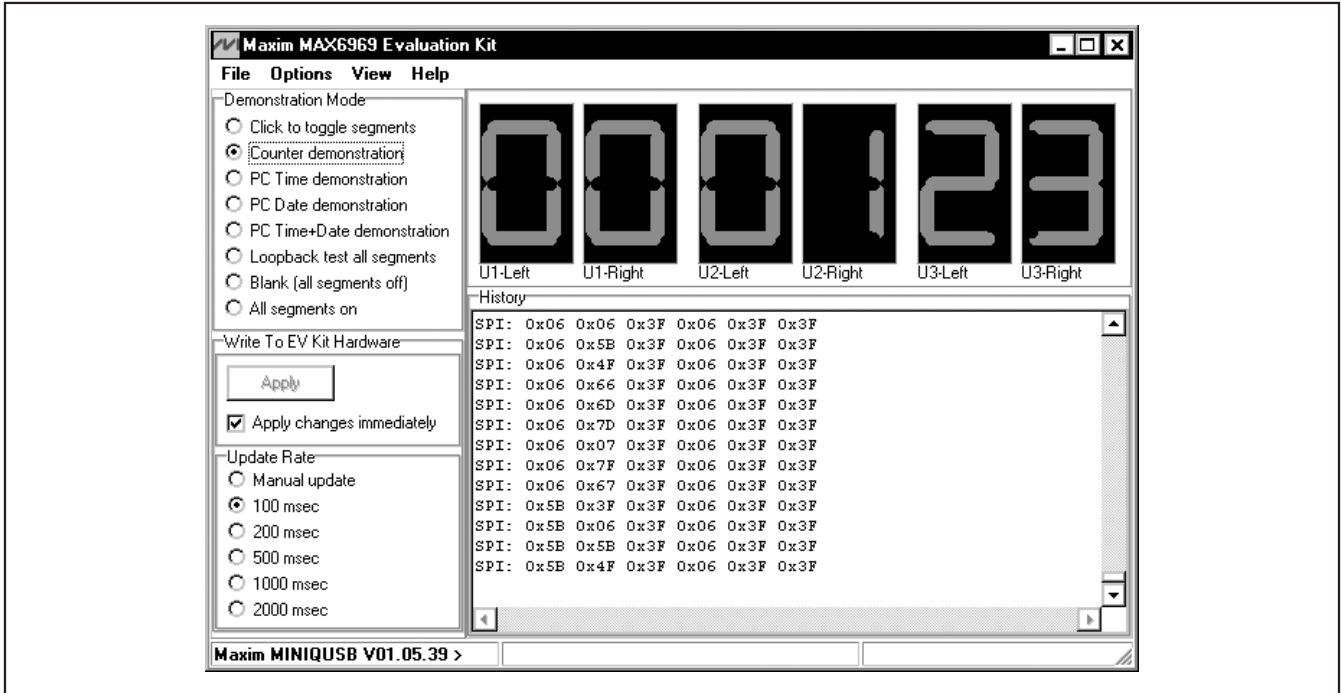

Figure 1. The MAX6969 EV Kit Software's Counter Demonstration (shows the 7-segment display counting up in decimal)

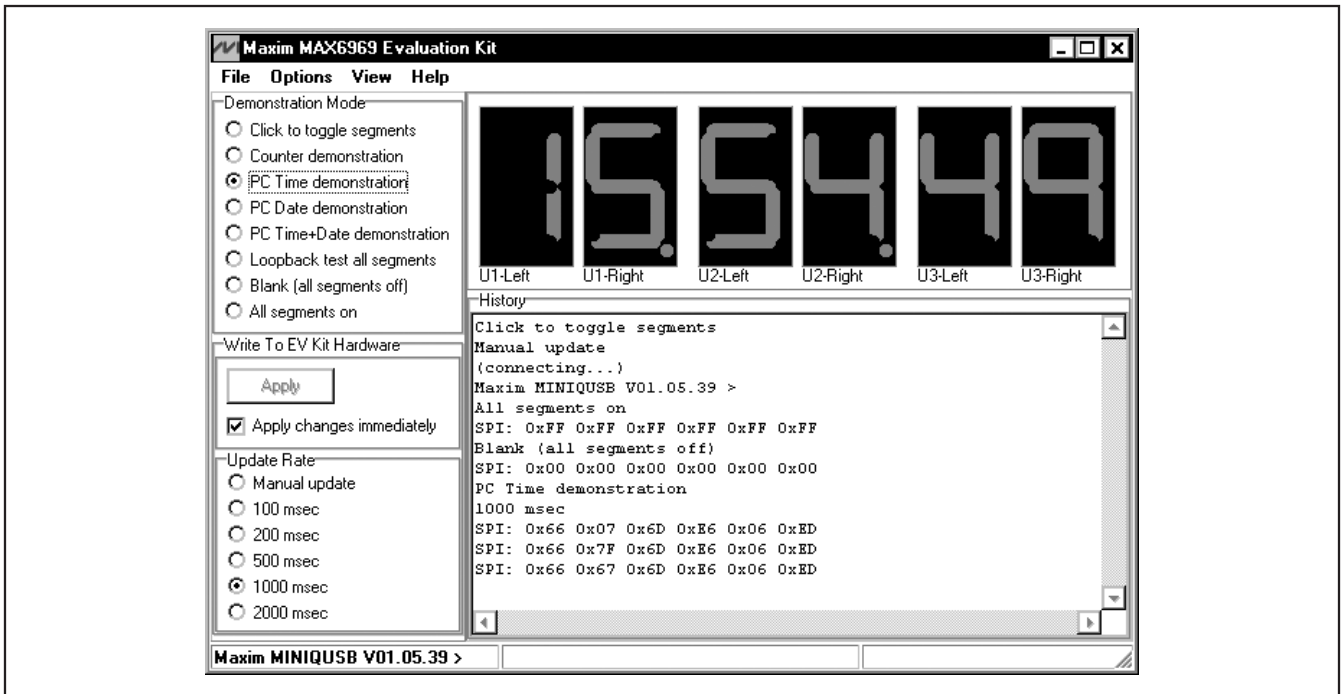

Figure 2. The MAX6969 EV Kit Software's PC Time Demonstration (displays the 24-hour time on the 7-segment display once every second)

# MAX6969 Evaluation Kit

Evaluates: MAX6969

**Table 1. Jumper Functions**

JUMPER	FUNCTION	SHUNT POSITION	DESCRIPTION
JU1	VLED	1-2*	LED1, LED2, and LED3 are powered from the 5V USB supply
		2-3	LED1, LED2, and LED3 are powered from external user-provided EXT VLED supply
JU2	$\overline{OE}$	1-2*	$\overline{OE}$ = GND, enabling the display
		No shunt	$\overline{OE}$ may be driven externally, disabling the display, or PWM dimming the brightness
JU3	Daisy chain	1-2*	Daisy-chain multiple devices MAXQ2000 MISO = from JU4 pin 2
		2-3	See Table 2
JU4	Daisy chain	1-2*	Daisy-chain multiple devices MAXQ2000 MISO = from JU5 pin 2
		2-3	See Table 2
JU5	Daisy chain	1-2	See Table 2
		2-3*	Daisy chain three devices: U1, U2, and U3 MAXQ2000 MISO = from U3 DOUT

\*Default position. To change configuration, first cut apart the corresponding connection on the back of the board.

**Table 2. Daisy-Chain Jumper Functions**

DAISY-CHAIN DEVICE CONFIGURATION	JU3	JU4	JU5	J2 JUMPER BLOCK
U1 only	2-3	X	X	1-2, 3-4, 5-6, 7-8*
U1-U2	1-2*	2-3	X	1-2, 3-4, 5-6, 7-8*
U1-U2-U3*	1-2*	1-2*	2-3*	1-2, 3-4, 5-6, 7-8*
U1-U2-U3-external devices	1-2 *	1-2*	1-2	1-2, 3-4, 5-6, 7-8*
External devices only	X	X	X	1 = DOUT from last device 3 = CLK to all devices 5 = DIN to first device 7 = LE to all devices

\*Default position. To change configuration, first cut apart the corresponding connection on the back of the board.

X = Don't care.

# MAX6969 Evaluation Kit

## **Detailed Description of Software**

The MAX6969 EV kit software provides several demonstration modes. Selecting **Click to toggle segments** allows arbitrary patterns to be entered by clicking on the segments in the GUI display, then clicking the **Apply** button. Selecting the **Counter demonstration**, **PC Time demonstration**, or **PC Date demonstration** mode displays numeric data. The **Loopback test all segments** mode is used during EV kit testing to verify that all three MAX6969 devices are daisy chained, and that each segment is individually controllable. The last two modes turn all segments off or all segments on.

### **History Window**

Each time the 7-segment display is updated, the SPI sequence is displayed in hexadecimal, in time sequence. The first 2 bytes control the last device in the daisy chain (U3). The last 2 bytes control the first device in the daisy chain (U1).

## **Detailed Description of Hardware**

Each MAX6969 (U1, U2, and U3) drives a dual 7-segment display (LED1, LED2, and LED3). LED4 indicates USB 5V power is present.

The FTDI FT232 (U5) provides the USB engine. The USB 5V power is regulated down to 3.3V and 2.5V by U7 and U8.

The low-voltage RISC microcontroller, MAXQ2000 (U4), processes commands sent by a program running on the PC. Each particular EV kit has its own custom software specific to that kit. The firmware loaded on this board is identical to the MINIQUSB interface module.

### **Using an External SPI Bus Instead of USB**

To disconnect from the on-board SPI bus, cut the links at jumper block J2 and jumper block JU1. Connect JU1, pins 2-3, and provide 5V power to the GND and EXT\_VLED oval pads. Connect the external SPI bus to the labeled test points of jumper block J2.

# MAX6969 Evaluation Kit

Evaluates: MAX6969

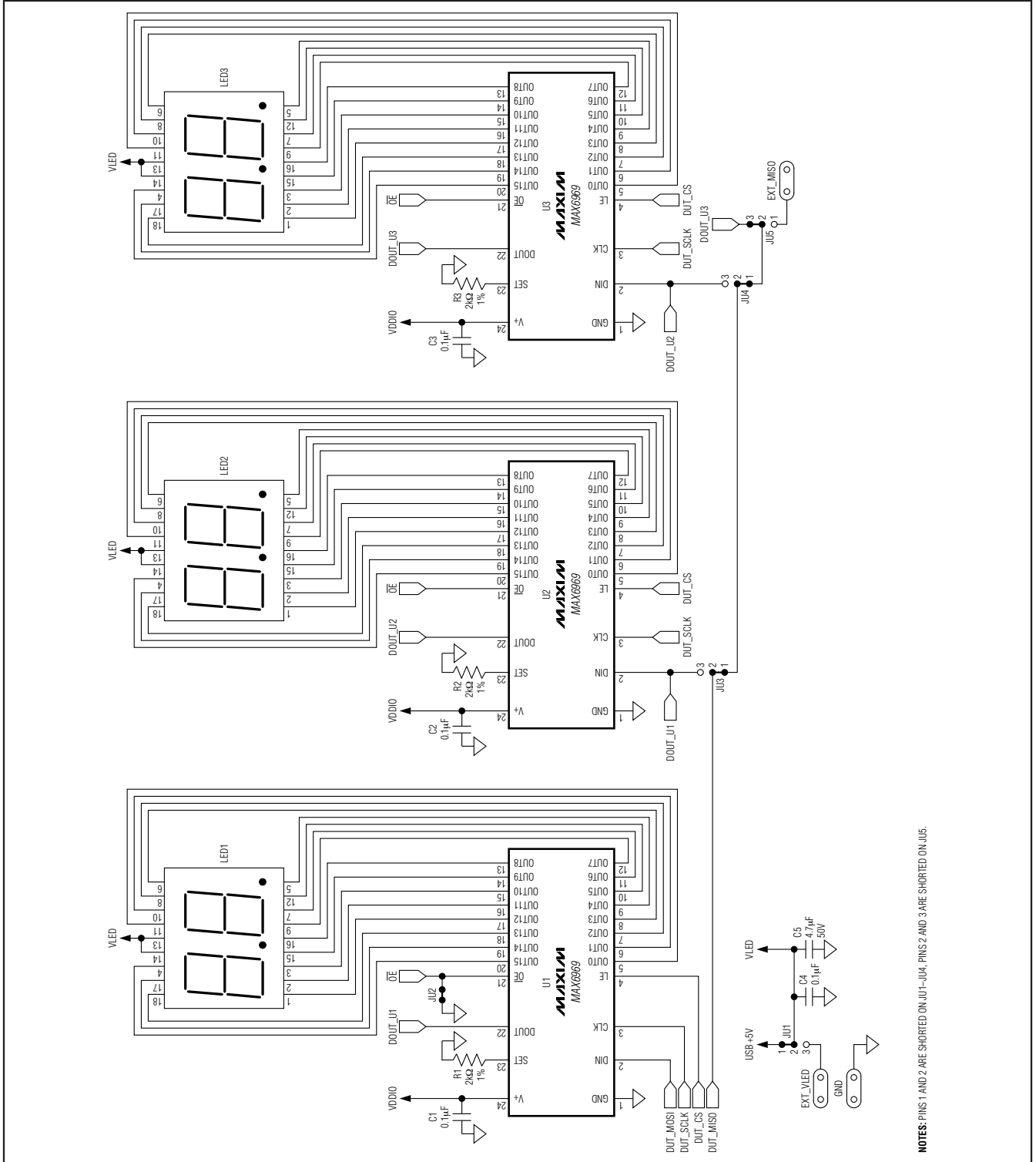

NOTES: PINS 1 AND 2 ARE SHORTED ON JU1-JU4. PINS 2 AND 3 ARE SHORTED ON JU5.

Figure 3a. MAX6969 EV Kit Schematic (Sheet 1 of 3)

# MAX6969 Evaluation Kit

Evaluates: MAX6969

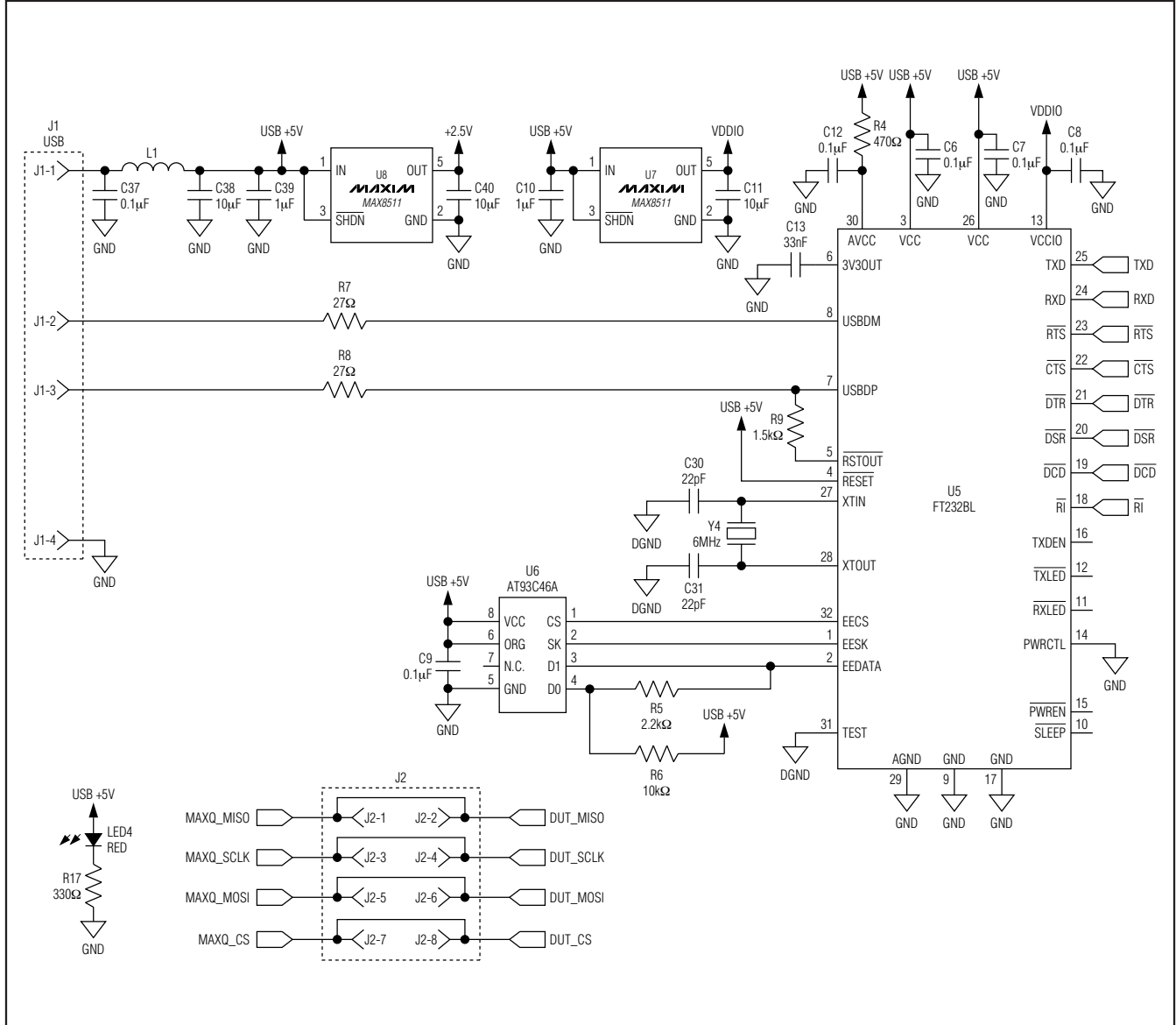

Figure 3b. MAX6969 EV Kit Schematic (Sheet 2 of 3)



# MAX6969 Evaluation Kit

Evaluates: **MAX6969**

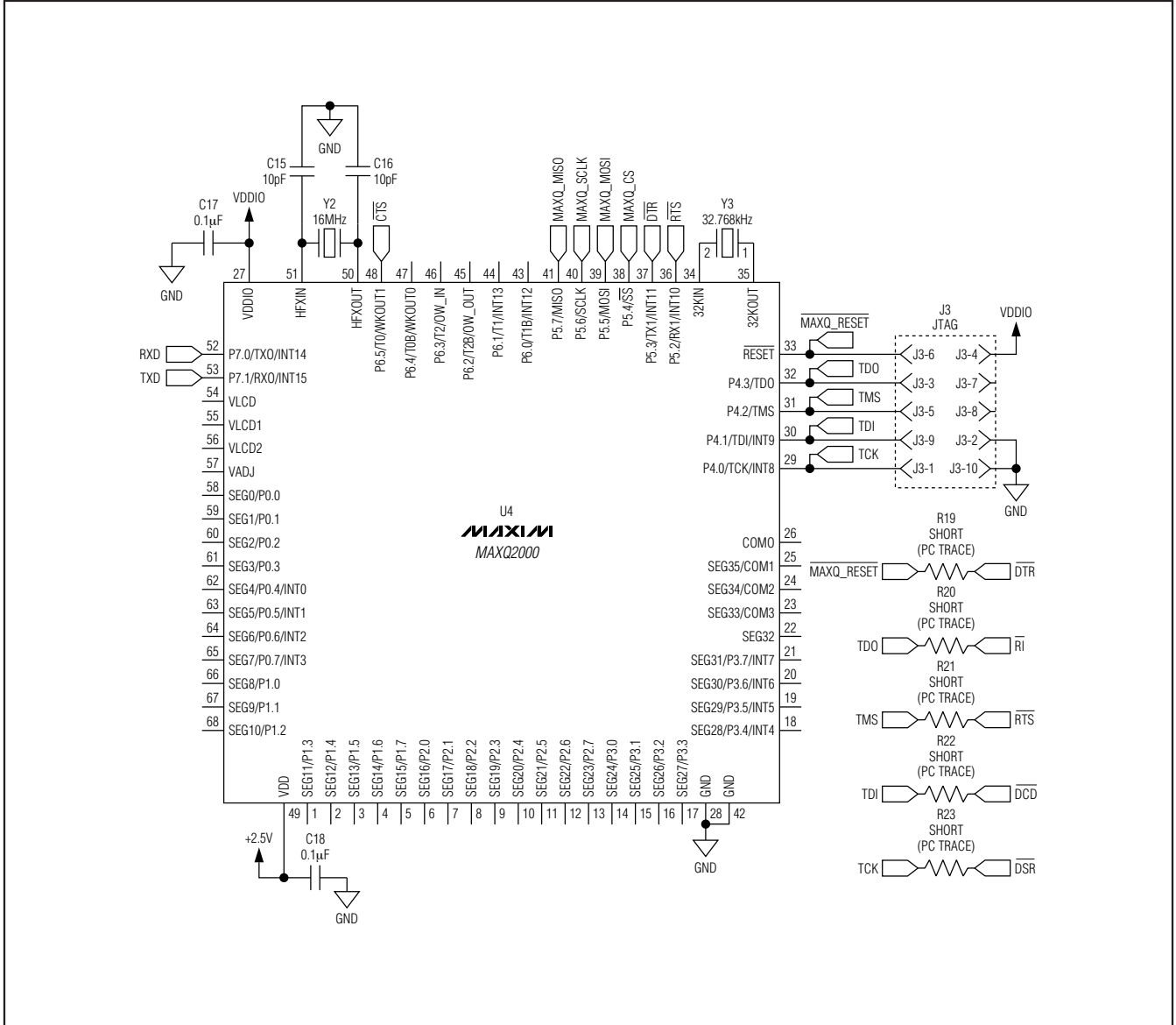

Figure 3c. MAX6969 EV Kit Schematic (Sheet 3 of 3)

# MAX6969 Evaluation Kit

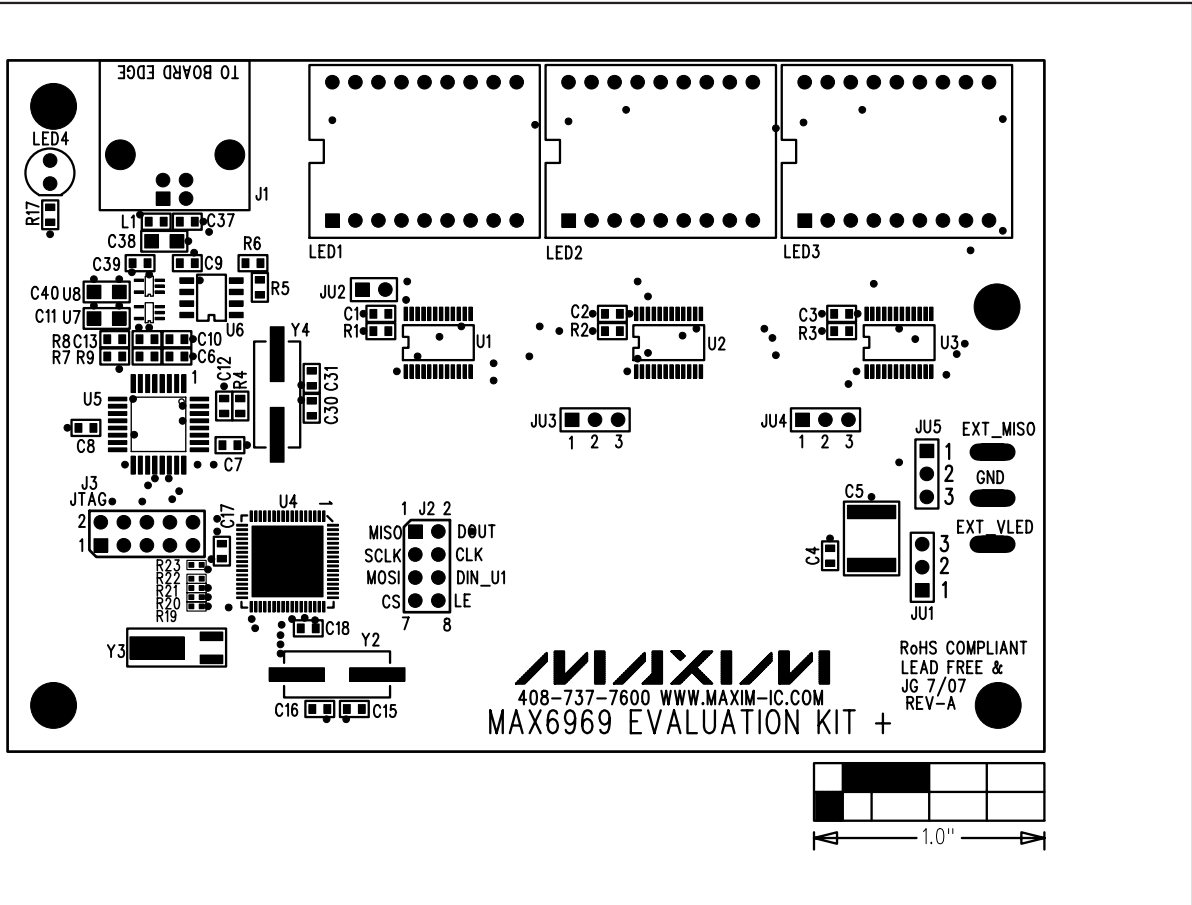

Figure 4. MAX6969 EV Kit Component Placement Guide—Component Side

# MAX6969 Evaluation Kit

Evaluates: MAX6969

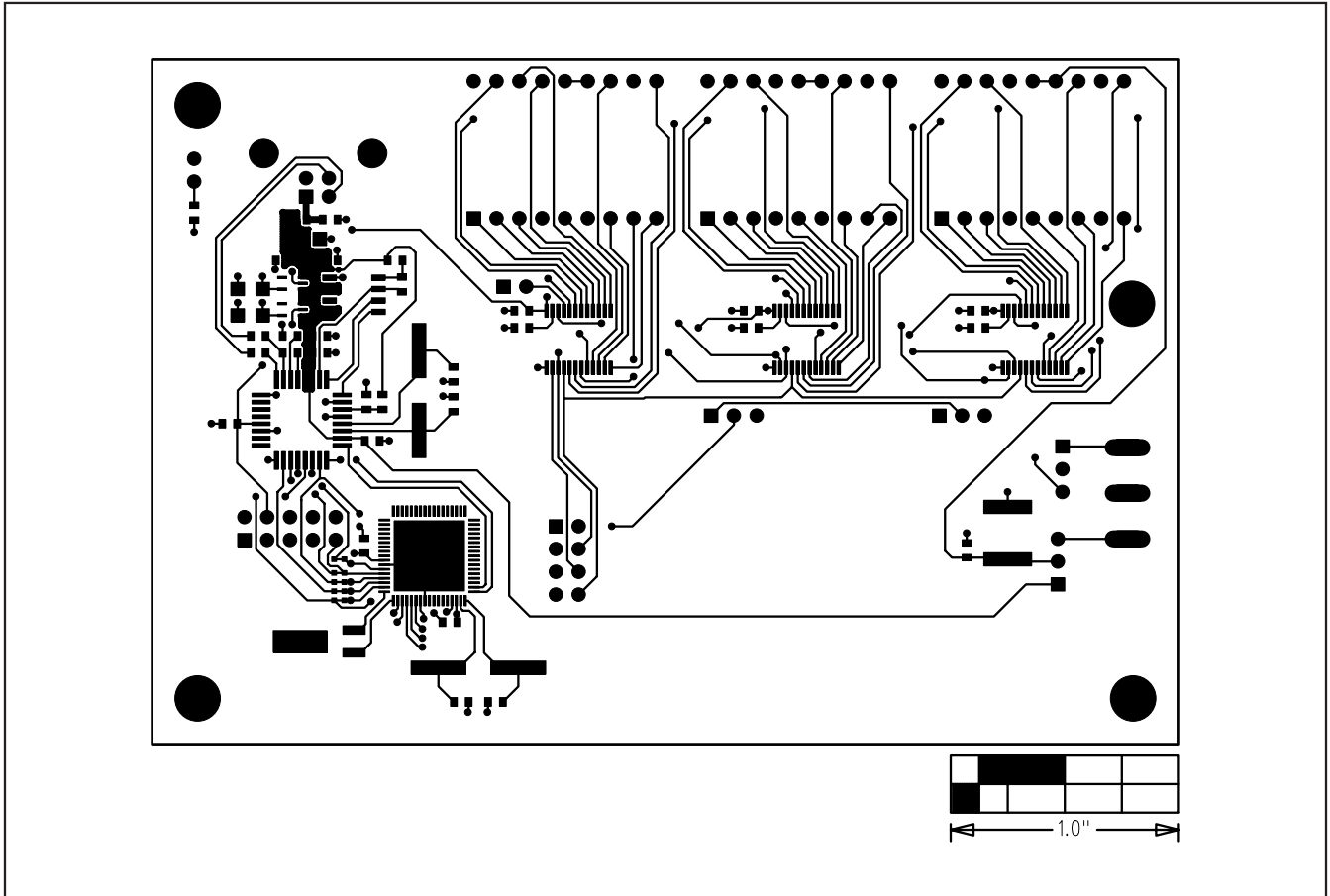

Figure 5. MAX6969 EV Kit PCB Layout—Component Side

# MAX6969 Evaluation Kit

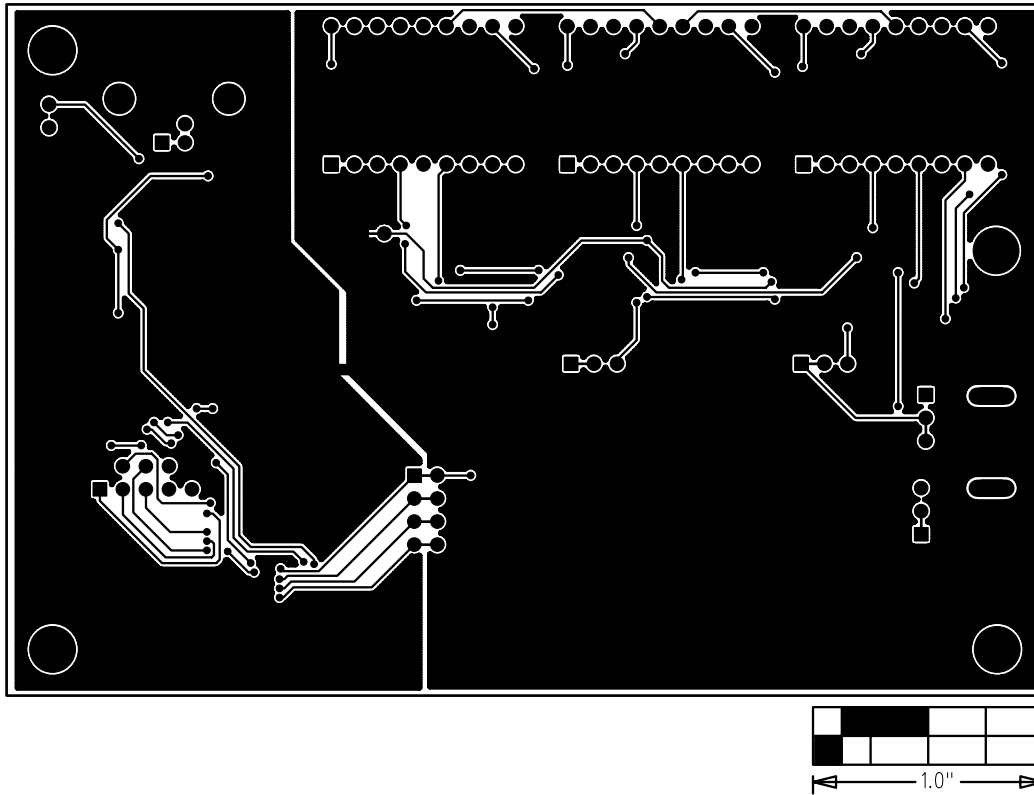

Figure 6. MAX6969 EV Kit PCB Layout—Solder Side

Maxim cannot assume responsibility for use of any circuitry other than circuitry entirely embodied in a Maxim product. No circuit patent licenses are implied. Maxim reserves the right to change the circuitry and specifications without notice at any time.

12 \_\_\_\_\_ **Maxim Integrated Products, 120 San Gabriel Drive, Sunnyvale, CA 94086 408-737-7600**