

FEATURES

Powerful companion design tool for quick design times
Input voltage range: 3.15 V to 14 V
Output voltage range: 0.8 V to V_{IN}
Output current: up to 10 A
Accommodating layout with multiple packages for diodes, PFETs, input and output capacitors, and inductors
3 PFETs in parallel for high current applications
Programmable compensation for optimizing transient performance
Programmable current limit with sense resistor(s)
Enable/shutdown logic
Switching frequency: 580 kHz
Kelvin connections for measuring input and output voltage

SHIPPED CONFIGURATION

Fully populated ADP1864-EVALZ
Input voltage range: 9 V to 12 V
Output voltage: 3.3 V
Output current: 3 A
Bare board ADP1864-BL-EVALZ
Populated with only ADP1864

EVALUATION BOARD DESCRIPTION

The ADP1864 evaluation board is designed to be used with the ADP1864 Buck Design Software. The evaluation board is configured to provide 3.3 V output at 3 A over an input voltage range of 9 V to 12 V. Through a versatile layout that accommodates several packages and a powerful companion design tool, the ADP1864 evaluation board can provide a wide variety of solutions, including up to a 5.0 V output at 10 A from a 12 V input. Kelvin connection terminals provide an accurate means for measuring the input and output voltages.

The evaluation board is designed to use the ADP1864 as an asynchronous, step-down dc-to-dc converter that uses a current mode pulse-width modulation control scheme. The ADP1864 drives a P-channel MOSFET that regulates an output voltage as low as 0.8 V with $\pm 1.25\%$ accuracy (up to 85°C), for up to 10 A load currents, from input voltages as high as 14 V. The ADP1864 provides system flexibility by allowing accurate setting of the current limit with an external resistor, while the output voltage is easily adjustable using two external resistors.

For more details, see the ADP1864 data sheet.

EVALUATION BOARD PHOTO

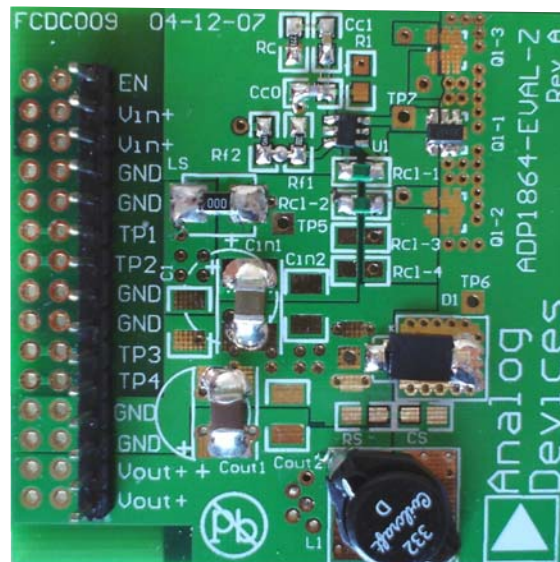

Figure 1. ADP1864-EVALZ

Rev. C

Evaluation boards are only intended for device evaluation and not for production purposes. Evaluation boards are supplied "as is" and without warranties of any kind, express, implied, or statutory including, but not limited to, any implied warranty of merchantability or fitness for a particular purpose. No license is granted by implication or otherwise under any patents or other intellectual property by application or use of evaluation boards. Information furnished by Analog Devices is believed to be accurate and reliable. However, no responsibility is assumed by Analog Devices for its use, nor for any infringements of patents or other rights of third parties that may result from its use. Analog Devices reserves the right to change devices or specifications at any time without notice. Trademarks and registered trademarks are the property of their respective owners. Evaluation boards are not authorized to be used in life support devices or systems.

TABLE OF CONTENTS

Features	1	Enter Performance Specifications	8
Shipped Configuration	1	Select Component Values and Sizes	9
Evaluation Board Description.....	1	Power Dissipation and Temperature	9
Evaluation Board Photo.....	1	Efficiency.....	9
Revision History	2	Application Schematic	9
Powering the Evaluation Board	3	BOM Summary	9
Input Power Source	3	Modifying the Evaluation Board.....	10
Output Load	3	Changing the MOSFET	10
Input and Output Voltmeters.....	3	Changing the Sense Resistor.....	10
Turning On the Evaluation Board.....	3	Changing the Diode.....	10
Measuring the Performance of the Evaluation Board	4	Changing the Output Inductor	10
Measuring Output Voltage Ripple.....	4	Changing the Output Capacitors	10
Measuring the Switching Waveform.....	4	Changing the Output Voltage.....	11
Measuring the Gate-to-Source Waveform	4	Schematic.....	12
Measuring the Inductor Current.....	4	Assembly Drawing	13
Measuring Efficiency and Load Regulation.....	4	Ordering Information.....	14
Measuring Line Regulation.....	4	Bill of Materials.....	14
Monitoring Short-Circuit Behavior	4	Ordering Guide	14
Typical Performance Characteristics	5	ESD Caution.....	14
Excel Design Tool Interface.....	8		

REVISION HISTORY

7/09—Rev. B to Rev. C

Changes to Changing the Output Voltage Section, Equation .. 11

6/08—Rev. A to Rev. B

Changes to Shipped Configuration Section.....	1
Changes to Figure 1	1
Changes to Powering the Evaluation Board Section	3
Changes to Figure 3 Caption.....	4
Changes to Excel Design Tool Interface Section Heading.....	8
Changes to Figure 18 Caption.....	8
Changes to BOM Summary Section	9
Changes to Changing the Output Capacitors Section.....	10
Changes to Figure 19.....	12
Added Figure 20 and Figure 21.....	13
Changes to Table 1.....	14
Added Table 2.....	14
Changes to Ordering Guide	14

6/07—Rev. 0 to Rev. A

4/06—Revision 0: Initial Version

POWERING THE EVALUATION BOARD

The ADP1864 evaluation board is supplied fully assembled or, optionally, populated with only the ADP1864 IC. Before applying power to the evaluation board, refer to Figure 2 and follow the procedures in this section.

INPUT POWER SOURCE

Before connecting the power source to the ADP1864 evaluation board, make sure that it is turned off. If the input power source includes a current meter, use that meter to monitor the input current. Connect the positive terminal of the power source to the V_{IN} terminal on the evaluation board, and the negative terminal of the power source to the GND terminal just below the V_{IN} terminal. If the power source does not include a current meter, connect a current meter in series with the input source voltage. Connect the positive lead (+) of the power source to the ammeter positive (+) connection, the negative lead (-) of the power source to the GND terminal just below the V_{IN} terminal on the evaluation board, and the negative lead (-) of the ammeter to the V_{IN} terminal on the board.

OUTPUT LOAD

Although the ADP1864 evaluation board can sustain the sudden connection of the load, it is possible to damage the load if it is not properly connected. Make sure that the board is turned off before connecting the load. If the load includes an ammeter, or if the current is not measured, connect the load directly to the evaluation board with the positive (+) load connection to the V_{OUT} terminal and the negative (-) load connection to the GND terminal just above the V_{OUT} terminal. If an ammeter is used, connect it in series with the load; connect the positive (+)

ammeter terminal to the evaluation board V_{OUT} terminal, the negative (-) ammeter terminal to the positive (+) load terminal, and the negative (-) load terminal to the evaluation board GND terminal just above the V_{OUT} terminal.

After the load is connected, make sure that it is set to the proper current before powering the ADP1864 evaluation board.

INPUT AND OUTPUT VOLTMETERS

Measure the input and output voltages with voltmeters. Connect the voltmeter measuring the input voltage with the positive lead (+) connected to TP1 and the negative lead (-) connected to TP2. Connect the voltmeter measuring the output voltage with the positive lead (+) connected to TP4 and the negative lead (-) connected to TP3. Make sure to connect the voltmeters to the appropriate evaluation board terminals and not to the load or power source themselves. If the voltmeters are not connected directly to the evaluation board at these Kelvin connection test points (TP1 to TP4), the measured voltages will be incorrect due to the voltage drop across the leads connecting the evaluation board to both the source and load.

TURNING ON THE EVALUATION BOARD

After the power source and load are connected to the ADP1864 evaluation board, the board can be powered for operation. Slowly increase the input power source voltage until the input voltage exceeds the minimum input operating voltage of 9 V. If the load is not already enabled, enable the load and check that it is drawing the proper current and that the output voltage maintains voltage regulation.

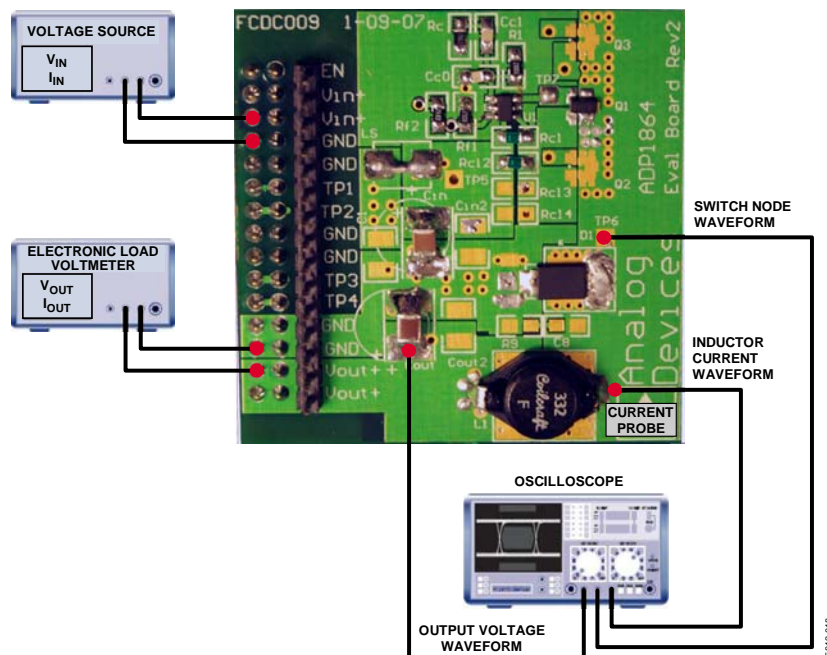

MEASURING THE PERFORMANCE OF THE EVALUATION BOARD

MEASURING OUTPUT VOLTAGE RIPPLE

To observe the output voltage ripple, place an oscilloscope across the output capacitor (C_{OUT}) with the probe ground lead at the negative (-) capacitor terminal and the probe tip at the positive (+) capacitor terminal. Set the oscilloscope to ac-coupled, 100 mV/division, and 2 μ s/division time base. For a more accurate measurement, the test leads should be as short as possible, as shown in Figure 3. The output ripple voltage increases as the input voltage is increased because the duty cycle is decreased.

MEASURING THE SWITCHING WAVEFORM

To observe the switching waveform with an oscilloscope, place the oscilloscope probe tip to TP6 with the probe ground at test point near the anode of the diode, which is on the GND plane. Set the scope to dc coupling, 2 V/division, and 2 μ s/division time base. The switching waveform should alternate between the negative forward voltage drop of the diode and approximately the input voltage with resonances near the switching transitions.

MEASURING THE GATE-TO-SOURCE WAVEFORM

To observe the gate-to-source waveform, place an oscilloscope probe at TP7 with the ground lead at the test point nearest to the anode of the diode, which is on the GND plane. Place another oscilloscope probe at the source of the MOSFET with the ground lead at the test point nearest the anode of the diode. Use the math functions of the oscilloscope to observe the gate-to-source waveform. Do not place a probe across gate-to-source terminals of the MOSFET unless a differential probe is being used. For a more accurate measurement, the test leads should be as short as possible, as shown in Figure 3.

MEASURING THE INDUCTOR CURRENT

The inductor current can be measured by removing one end of the inductor from its pad and connecting a wire with adequate current handling capabilities from the pad to inductor lead. Then, a current probe can be used to measure the current through the inductor, as shown in Figure 2.

MEASURING EFFICIENCY AND LOAD REGULATION

Using the voltages from the voltmeters and current readings from the source and load, calculate efficiency from the following equation:

$$n = \frac{V_{OUT} \times I_{OUT}}{V_{IN} \times I_{IN}}$$

Sweep the load across the full load range to obtain the efficiency and load regulation plot.

The efficiency results should correspond to the [ADP1864 Buck Design Software](#).

MEASURING LINE REGULATION

Vary the input voltage and examine the change in the output voltage reading from the voltmeter.

MONITORING SHORT-CIRCUIT BEHAVIOR

Place a current probe on the load cable that connects the output to the positive input of the electronic load. Monitor the output voltage with a similar technique used to measure the output voltage ripple; however, dc couple the scope with a 5 V/div setting. Many electronic loads have short-circuit capability. Enable this function on the load and ensure that the circuit current limits at the correct current.

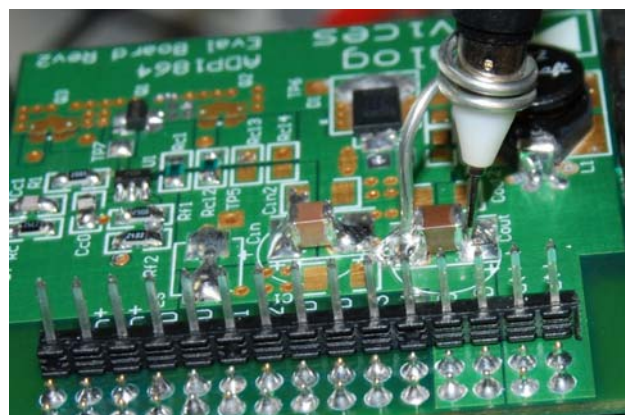

Figure 3. Measuring Technique for Output Voltage Ripple

TYPICAL PERFORMANCE CHARACTERISTICS

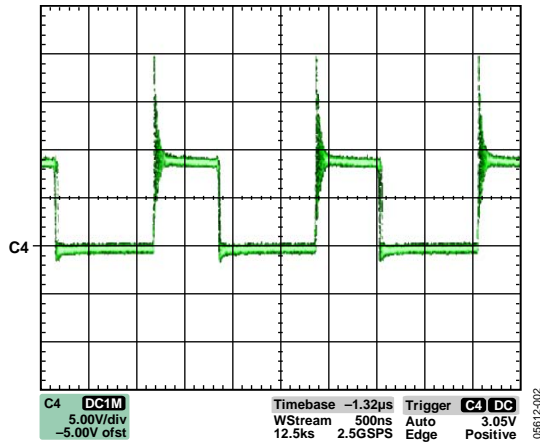

Figure 4. Switch Node Ringing at 3 A Load; $V_{IN} = 9\text{ V}$

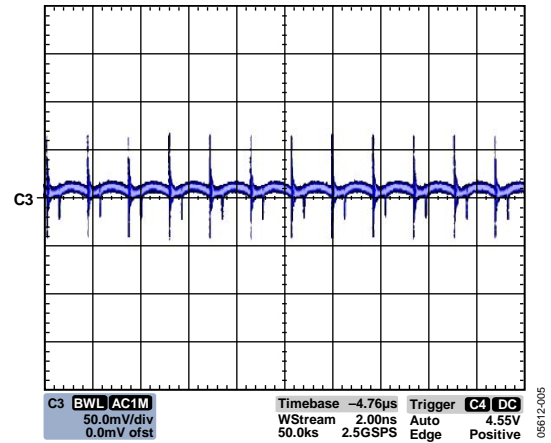

Figure 7. V_{OUT} Ripple at 3 A Load; $V_{IN} = 12\text{ V}$

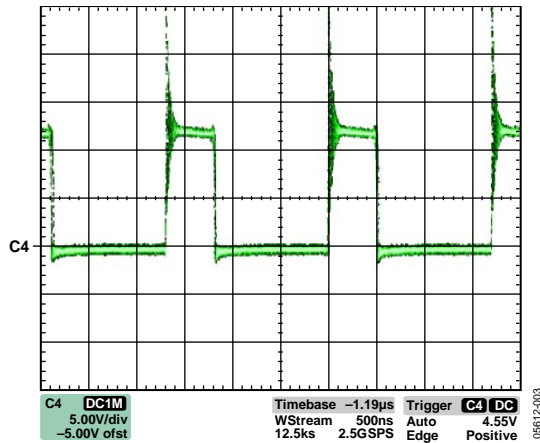

Figure 5. Switch Node Ringing at 3 A Load; $V_{IN} = 12\text{ V}$

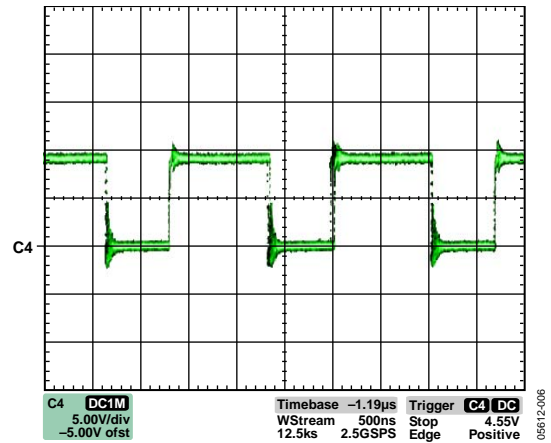

Figure 8. Gate Waveform 3 A; $V_{IN} = 9\text{ V}$

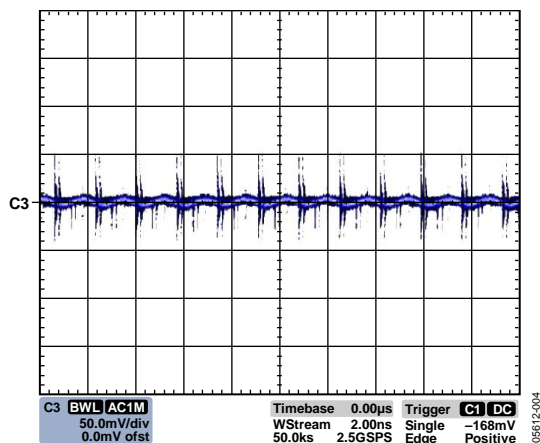

Figure 6. V_{OUT} Ripple at 3 A Load; $V_{IN} = 9\text{ V}$

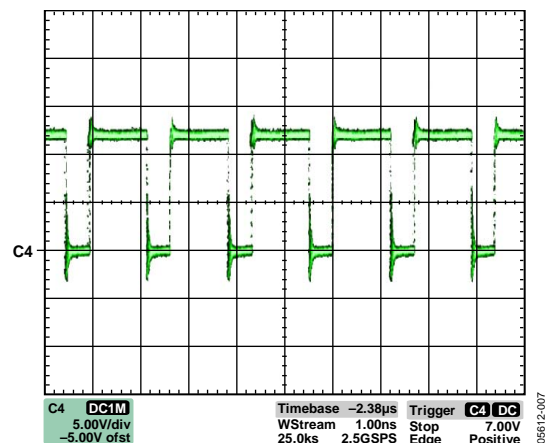

Figure 9. Gate Waveform 3 A; $V_{IN} = 12\text{ V}$

EVAL-ADP1864

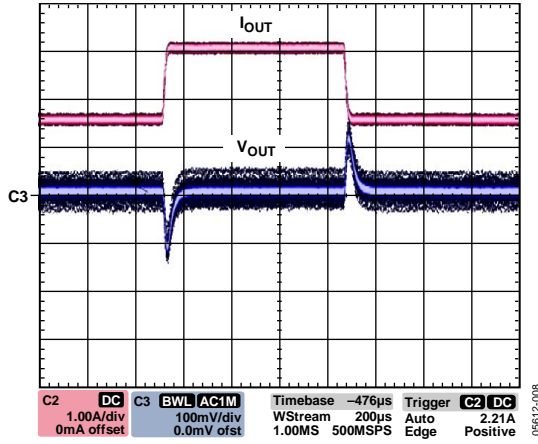

Figure 10. Load Transient; 1.5 A to 3 A at 250 mA/μs, VIN = 9 V

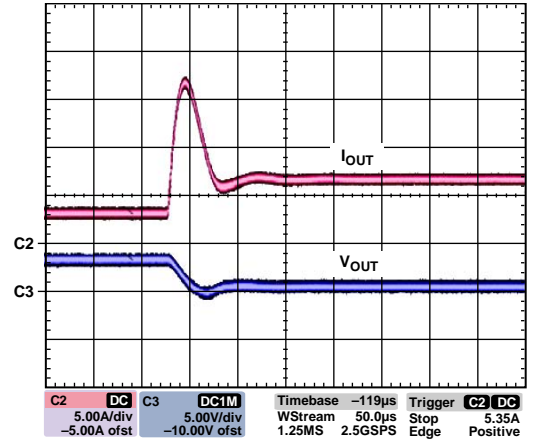

Figure 13. Short Circuit; VIN = 12 V

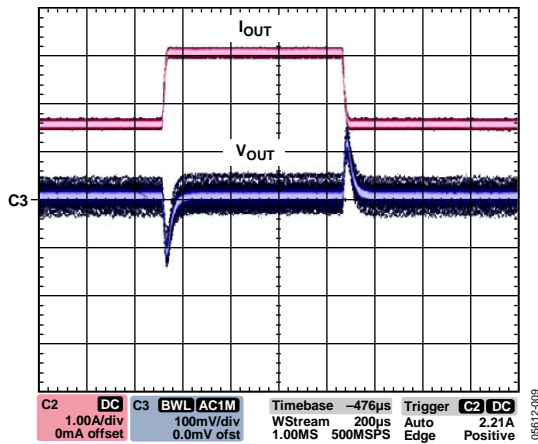

Figure 11. Load Transient; 1.5 A to 3 A at 250 mA/μs, VIN = 12 V

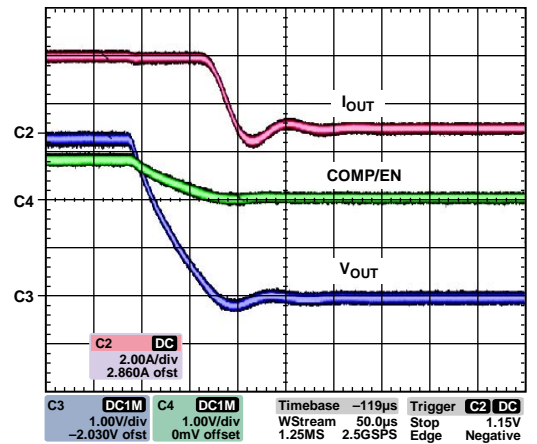

Figure 14. Disable; VIN = 9 V

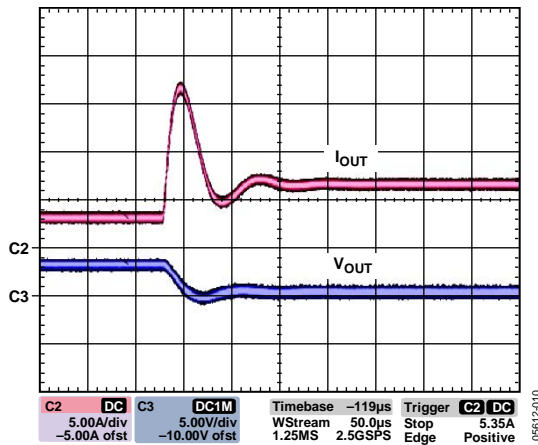

Figure 12. Short Circuit; VIN = 9 V

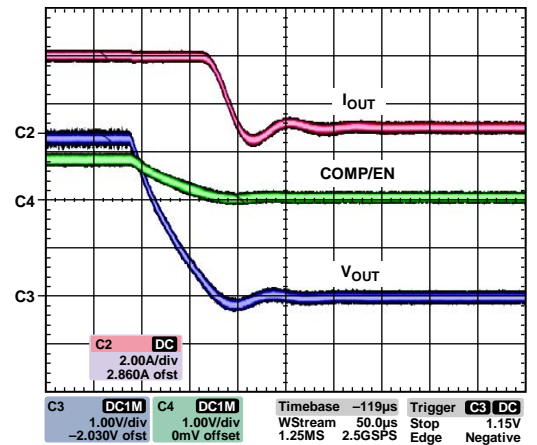

Figure 15. Disable; VIN = 12 V

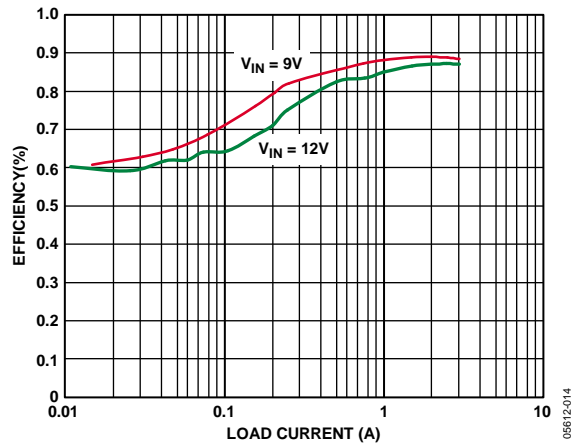

Figure 16. Efficiency vs. Load Current

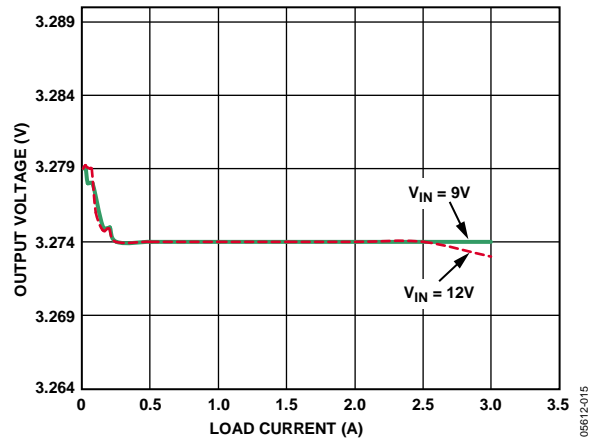

Figure 17. Load Regulation

EXCEL DESIGN TOOL INTERFACE

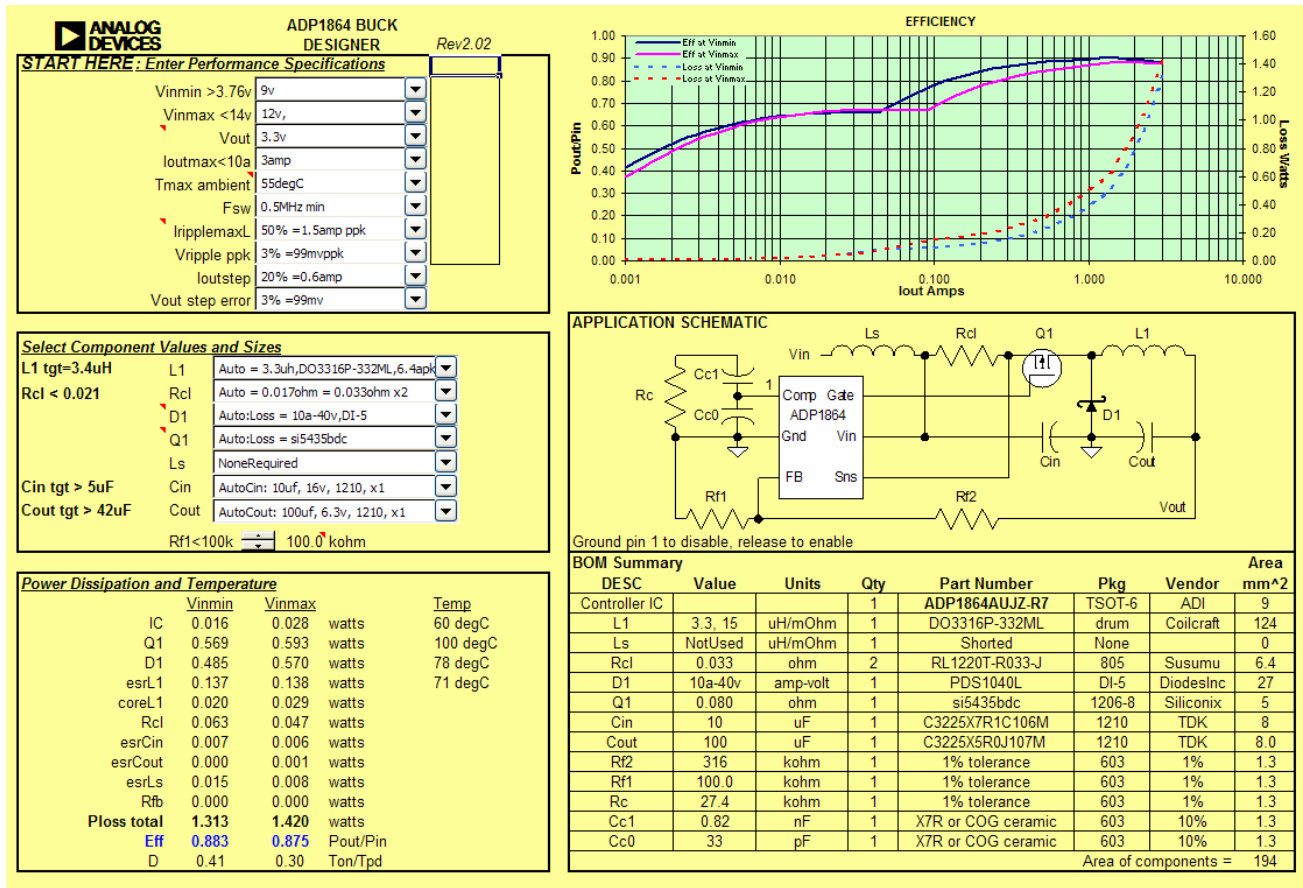

Figure 18. Excel Design Tool Interface

ENTER PERFORMANCE SPECIFICATIONS

In this section, the user can provide the specifications on how the power supply being designed needs to perform. The voltage range for the first two pull-down menus (**Vinmin** and **Vinmax**) is 3.15 V to 14 V. In the third pull-down menu, the user provides the required regulated output voltage (**Vout**), which needs to be less than Vinmin and Vinmax, because this tool is to be used with the buck topology. The next pull-down menu is the required output current (**Ioutmax**). It is wise to design for the peak current the regulator needs to provide, even if the peak is required for only a short period of time. Without taking this into consideration, it is possible to hit the current limit when peak current is needed. The information provided in the ambient temperature (**Tmax ambient**) pull-down menu allows the estimated temperature to be computed for each component. This is a required piece of information to ensure that the parts selected are thermally capable of handling the rise in temperature associated with internal losses of the parts. The switching frequency is internally set in the **ADP1864** to 580 kHz. There is a tolerance on this specification, and the minimum and maximum limits can be selected through the pull-down menu (**Fsw**). When the switching frequency is at a minimum, the current in the

inductor rises to a slightly higher amplitude than in the nominal switching frequency case. Consequently, the voltage across the sense resistor will also be higher, which needs to be accounted for when the tool calculates the current limit trip point. A robust design should always consider this minimum switching frequency. Additionally, the performance of the system can be viewed when selecting the maximum switching frequency from the pull-down menu.

The inductor ripple selection (**IripplemaxL**) affects several parameters. As a general guideline, it is recommended to set this value between 30% to 50% of the output load. A small inductor allows energy to be transferred from the input to the output more quickly during a load step, resulting in a smaller output voltage excursion during the load step. However, a small inductor requires a higher current rating of the inductor itself, that is, the ripple current is inversely proportional to the size of the inductor. Higher ripple current also translates to higher output voltage ripple for a fixed capacitance value. Selecting the maximum output voltage ripple from the next pull-down menu (**Wripple ppk**) determines the amount and type (MLCC, aluminum electrolytic, for example) of output capacitance needed and correspondingly how the compensation components are sized.

As a general guideline, it is recommended to set this value around 5%. In the next pull-down menu (**Ioutstep**), the user can select the estimate of the largest step in load the regulator will demand. This, in conjunction with the allowable voltage excursion on load transient (in the **Vout step error** pull-down menu), delegates how much output capacitance is required. If the **Ioutstep** specification is not known, entering a 50% load step provides an adequate design for most applications at the power level the ADP1864 is designed to be used.

SELECT COMPONENT VALUES AND SIZES

When starting a new design, it is recommended to reset each of the pull-down menus to **Auto**, which is at the top of the list for each option. With these settings, the tool automatically calculates the most efficient design and provides that solution. If the user would like to explore how other components affect various parameters of the system, all the parts of the regulator except the compensation components can be changed through the use of the pull-down menus in this section. Note that the tool provides a bill of materials that maintains all specifications entered in the **Enter Performance Specifications** section of the tool when a component is changed. Accordingly, other component values can change as well. The feedback resistor selector at the bottom of this section finds the right combination of resistors to provide the feedback voltage with the 0.8 V.

POWER DISSIPATION AND TEMPERATURE

The **Power Dissipation and Temperature** section of the tool provides the user with the power dissipation of each part at the full rated current at both the maximum and minimum input voltages. It also provides the user with the estimated temperature of the ADP1864, the MOSFET, the diode, and the inductor. These calculations are done taking into account the temperature rise due to dissipation as well as the ambient temperature.

EFFICIENCY

From the power dissipation information calculated in the **Power Dissipation and Temperature** section of the tool, the efficiency across the full load range is plotted for both maximum and minimum input voltages.

APPLICATION SCHEMATIC

The **Application Schematic** section provides a schematic of the ADP1864 evaluation board. The reference designators on the evaluation board match this schematic.

BOM SUMMARY

The **BOM Summary** provides the user with the final parts list necessary to meet all the requirements entered into the performance specifications section. Vendors, part numbers, individual and total area, along with a value for each component, are provided. If no part number is provided, a vital specification is given instead. This specification can be used to find a part to populate on the board. From this BOM, the user can modify the fully populated configuration or populate the bare board configuration to validate design changes.

MODIFYING THE EVALUATION BOARD

The ADP1864-EVALZ evaluation board is complete and tested for operation. Due to the versatility of the ADP1864 step-down dc-to-dc controller, the ADP1864 evaluation board can be modified for a variety of external components. Some of the most common modifications are described in this section.

CHANGING THE MOSFET

The ADP1864-EVALZ evaluation board is supplied with a Siliconix Si5435 power MOSFET. The layout can accommodate MOSFETs placed in parallel to accommodate higher current levels. Additionally, 8-lead SOIC, thermally enhanced 8-lead SOIC, 6-lead TSOP, 1206-8, and SOT-23 packages all have footprints available on the ADP1864 evaluation board. On resistances, gate charges and capacitances, gate-to-source thresholds, and maximum drain to source voltage ratings should all be considered before changing the MOSFET.

CHANGING THE SENSE RESISTOR

If an increase in current capability is desired, it may be necessary to change the current limit via the sense resistor. As supplied, two 33 mΩ resistors in parallel are used to sense current. For duty cycles <40%, the current limit voltage is 125 mV typically. For duty cycles >40%, use the slope factor (SF) vs. duty cycle plot in the ADP1864 data sheet to determine the actual current sense limit.

Note that across the full temperature range and input voltage range of the ADP1864, the current limit voltage can be as low as 80 mV.

CHANGING THE DIODE

The ADP1864-EVALZ evaluation board is supplied with a Diodes, Inc. PDS1040L Schottky diode. The board can accommodate SMC, DPAK (TO-252), and other popular packages. The two primary factors to consider when changing the diode are the current handling capabilities as well as the maximum reverse dc blocking voltage. Because of switch node voltage excursions, it is recommended to select a diode with at least three times the reverse dc blocking voltage as the maximum input voltage for the application when no snubber circuit is used.

CHANGING THE OUTPUT INDUCTOR

The ADP1864-EVALZ evaluation board is populated with a Coilcraft DO3316P-332ML 3.3 μH inductor with a saturation current of 6.4 A. To operate at currents higher than this, the inductor needs to be modified to accommodate at least the higher current plus half the inductor ripple current. If the current demand is less, it could be advantageous to select a physically smaller and lower saturation current inductor for cost considerations. Changing the inductance value can affect the stress on the transistor and diode, the output voltage ripple, and the load transient response. The [ADP1864 Buck Design Software](#) accounts

for all these changes when the new inductance value is selected from the L1 pull-down menu. It then provides new suggestions for component values. The Applications Information section of [ADP1864](#) data sheet also provides information concerning the implications of changing the output inductor. If the duty cycle is to exceed 40%, keep the ripple current to 30% to 50% of the output current so that the slope compensation remains effective. See the ADP1864 data sheet for more details.

CHANGING THE OUTPUT CAPACITORS

The ADP1864-EVALZ evaluation board is supplied with a 100 μF ceramic capacitor on the output. If the capacitance is insufficient to meet load transient requirements, a D-case tantalum capacitor footprint and an 8 mm electrolytic capacitor footprint are available to provide the capability to greatly increase the output capacitance. Any change in output capacitance also requires a change in compensation component values. To compensate for a change in output capacitor, use the following equations:

$$R_C = \frac{2\pi \times f_{UN} \times C_{OUT} \times (ESR + R_{LOAD})^2 \times V_{OUT} \times R_{CL} \times G_C}{G_M \times R_{LOAD}^2 \times V_{REF}}$$

$$C_{CI} = \frac{3}{2\pi \times R_C \times f_{UN}}$$

$$C_{CO} = \frac{G_M \times R_{LOAD} \times ESR \times V_{REF}}{2\pi \times f_{UN} \times (ESR + R_{LOAD}) \times R_{CL} \times G_C \times V_{OUT}} \text{ or}$$

$$C_{CO} = \frac{3}{2\pi \times R_C \times f_{SW}}, \text{ whichever is larger.}$$

where:

f_{UN} is the desired unity gain frequency in hertz (usually 40 kHz).

C_{OUT} is output capacitance in farads.

ESR is the effective series resistance of C_{OUT} in ohms.

R_{LOAD} is V_{OUT} (volts)/maximum load current (amps).

R_{CL} is the parallel resistance of the current sense resistors in ohms.

G_C is the nominal gain of the current sense amplifier (12).

G_M is the nominal gain of the error amplifier (2.4×10^{-4} mhos).

V_{REF} is the nominal error amplifier reference voltage (0.8 V).

f_{SW} is the nominal switching frequency of the ADP1864 (580 kHz).

If multiple output capacitors are used and of the same type and value, ESR is defined as the parallel effective series resistance of all the capacitors. If multiple output capacitors are used that are not of the same type and value, the analysis to calculate optimal compensation components is considerably more complicated and beyond the scope of this document.

It is recommended to always refer to the manufacturer's data for capacitance derating over applied voltage and temperature.

CHANGING THE OUTPUT VOLTAGE

The ADP1864-EVALZ evaluation board output regulation voltage can be changed by altering the voltage divider consisting of R_{F2} and R_{F1} . The output regulation voltage is determined by the following equation:

$$V_{OUT} = 0.8 \times \left(\frac{R_{F2} + R_{F1}}{R_{F1}} \right)$$

Modifying the output voltage changes the inductor ripple current and subsequently the output voltage ripple, transient response, and stress on the PFET. The design tool considers this and, if necessary, provides new component values.

EVAL-ADP1864

SCHEMATIC

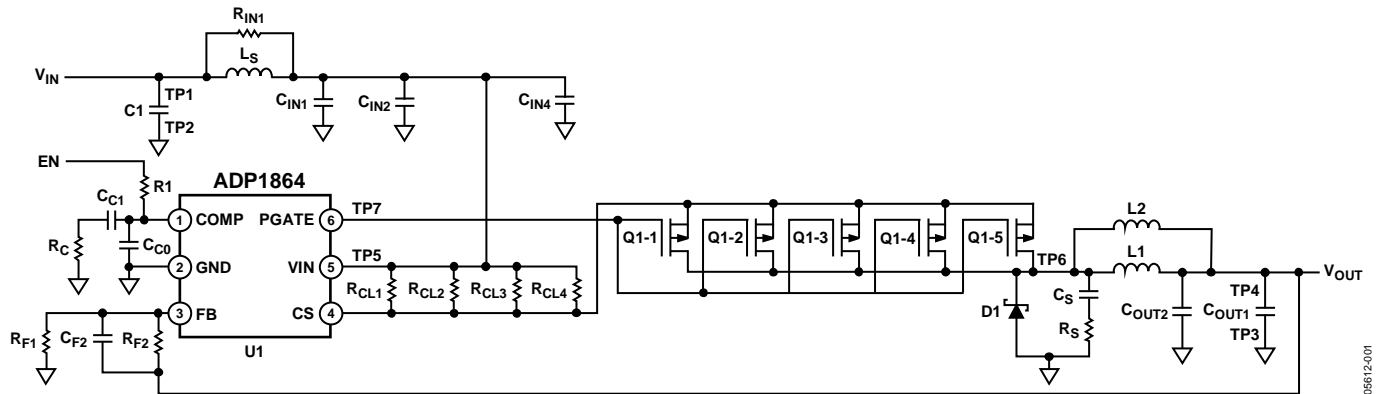

Figure 19. ADP1864-EVALZ Evaluation Board Schematic

100-21950

ASSEMBLY DRAWING

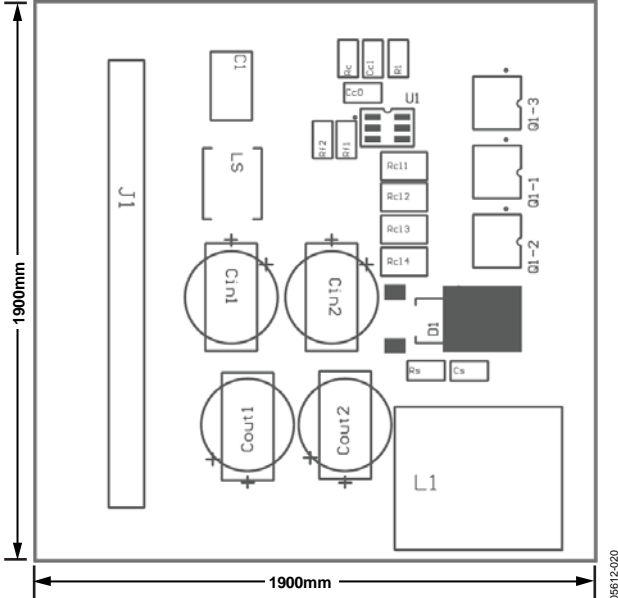

Figure 20. ADP1864-EVALZ Evaluation Board Assembly Drawing, Front

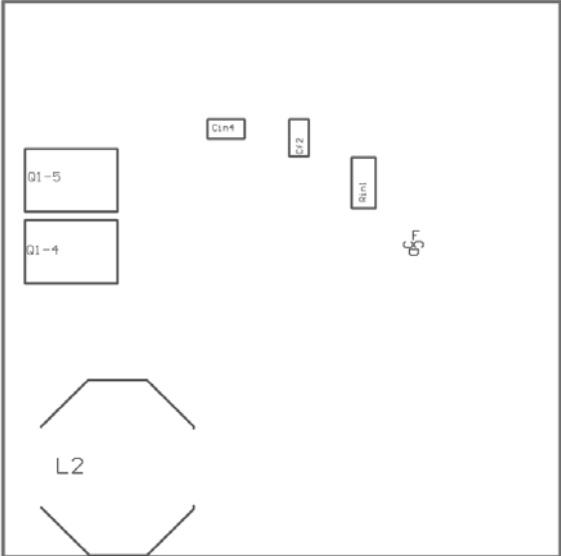

Figure 21. ADP1864-EVALZ Evaluation Board Assembly Drawing, Back

EVAL-ADP1864

ORDERING INFORMATION

BILL OF MATERIALS

Table 1. ADP1864-EVALZ

Designator	Value	Qty.	Package	Area (mm ²)	Manufacturer and Part Number	Comments
U1		1	6-lead TSOT	9	Analog Devices ADP1864AUJZ-R7	
C _{CO}	33 pF	1	0603	1.3		X7R or COG ceramic, 10% tolerance
C _{C1}	0.82 nF	1	0603	1.3		X7R or COG ceramic, 10% tolerance
C _{IN1}	10 μF	1	1210	8	TDK C3225X7R1C106M	
C _{OUT1}	100 μF	1	1210	8.0	TDK C3225X5R0J107M	
R _C	27.4 kΩ	1	0603	1.3		1% tolerance
R _{CL1} , R _{CL2}	0.033 Ω	2	0805	6.4	Susumu RL1220T-R033-J	
R _{F1}	80.6 kΩ	1	0603	1.3		1% tolerance
R _{F2}	249 kΩ	1	0603	1.3		1% tolerance
L1	3.3 μH, 15 mΩ	1	Drum	124	Coilcraft DO3316P-332ML	
L _S	Short	1	None	0		Shorted
D1	10 A, 40 V	1	DI-5	27	Diodes, Inc. PDS1040L	
J1	15-pin header	1	Header	96.8	Samtec HTSW-115-07-T-S	
Q1-1	0.080 Ω	1	1206-8	5	Siliconix Si5435BDC	
C1, C _{IN2} , C _{IN4} , C _{F2} , C _{OUT2} , C _S , R1, R _{IN1} , R _{CL3} , R _{CL4} , R _S , L2, Q1-2, Q1-3, Q1-4, Q1-5						Not populated

Table 2. ADP1864-BL-EVALZ

Designator	Value	Qty.	Package	Area (mm ²)	Manufacturer and Part Number	Comments
U1		1	6-lead TSOT	9	Analog Devices ADP1864AUJZ-R7	
J1	15-pin header	1	Header	96.8	Samtec HTSW-115-07-T-S	

ORDERING GUIDE

Model	Description
ADP1864-EVALZ ¹	Evaluation Board
ADP1864-BL-EVALZ ¹	Blank Evaluation Board

¹ Z = RoHS Compliant Part.

ESD CAUTION



ESD (electrostatic discharge) sensitive device. Charged devices and circuit boards can discharge without detection. Although this product features patented or proprietary protection circuitry, damage may occur on devices subjected to high energy ESD. Therefore, proper ESD precautions should be taken to avoid performance degradation or loss of functionality.

NOTES

EVAL-ADP1864

NOTES