

Application & Main Feature

Commercial Grade (Soft Termination)

Series

C3225 [EIA CC1210]

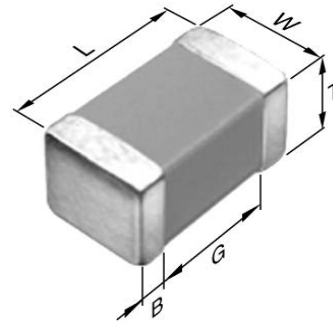

Dimensions

L	3.20mm +0.5,-0.4mm
W	2.50mm +/-0.3mm
T	1.60mm +0.3,-0.2mm
B	0.20mm Min.
G	

Temperature Characteristic

C0G (-55 to 125 degC 0+/-30ppm/degC)

Rated Voltage

2J (630Vdc)

Capacitance

15nF

Capacitance Tolerance

J (+/-5%)

Q Factor

1000 Min.

Insulation Resistance

10Gohm Min

AEC-Q200

Not Applicable

**|Z|, ESR vs. Freq. Characteristics
(Simulation Data)**

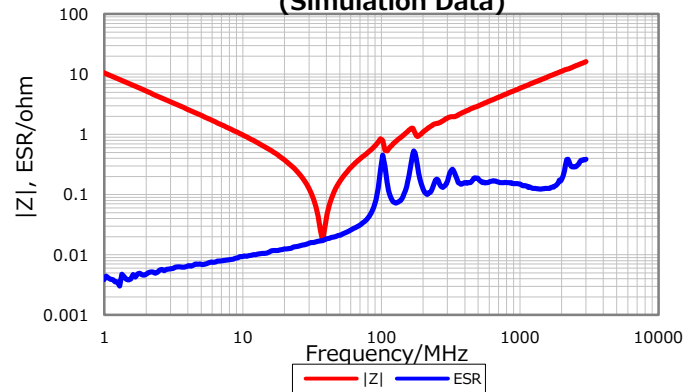

DC Bias Characteristic

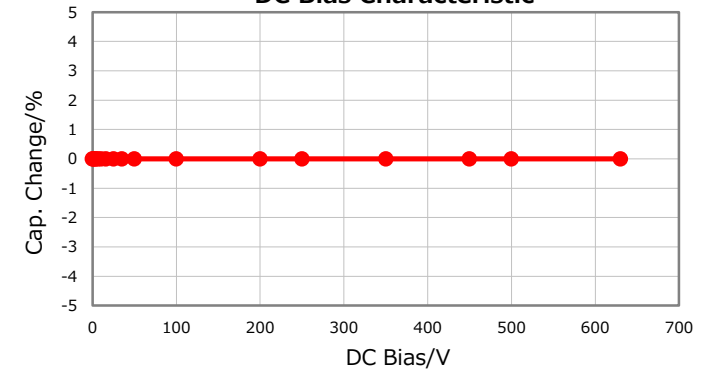

Cap. vs. Freq. Characteristic

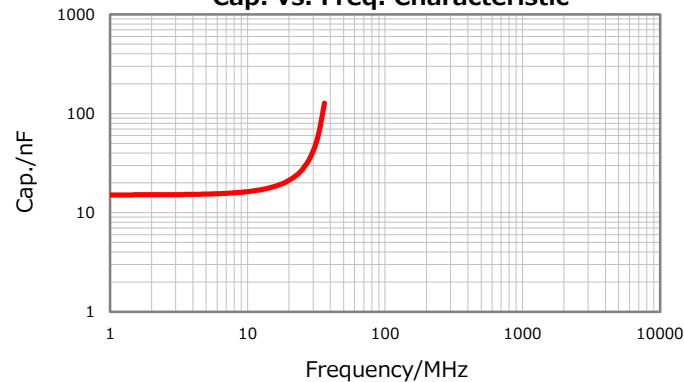

Temperature Characteristics

