

IRPLLNR7

Universal Input Linear Fluorescent Ballast Using the IRS2166D

Features

- Drives one 35 W TL5 Lamp
- Input Voltage: 80 VAC to 260 VAC
- High Power Factor/Low THD
- High Frequency Operation
- Lamp Filament Preheating
- Lamp Fault Protection with Auto-Restart
- Low AC Line Protection
- End of Lamp Life Shutdown
- **IRS2166D(S)PbF** HVIC Ballast Controller

Table of Contents

	Page
1. Description.....	2
2. Ballast Block Diagram.....	2
3. Electrical Characteristics.....	3
4. Fault Protection Characteristics.....	3
5. Overview.....	3
6. Schematic Diagram.....	4
7. PCB Layout and Component Placement Diagram.....	5
8. Bill of Materials.....	6
9. Inductor Specifications (PFC Inductor)	7
10. Inductor Specifications (Resonant Inductor)	8
11. Demo Board Overview.....	9
12. Power Factor Correction Section.....	9
13. Ballast Control Section.....	9
14. Startup Mode.....	9
15. Preheat Mode.....	10
16. Ignition Ramp Mode.....	12
17. Run Mode.....	13
18. Normal Power Down and Brown-Out Reset.....	14
19. Lamp Removal and Auto-Restart.....	14
20. Fault Mode.....	14
21. Current Mode Configuration.....	17
22. Design Procedure for Different Lamp Types.....	18

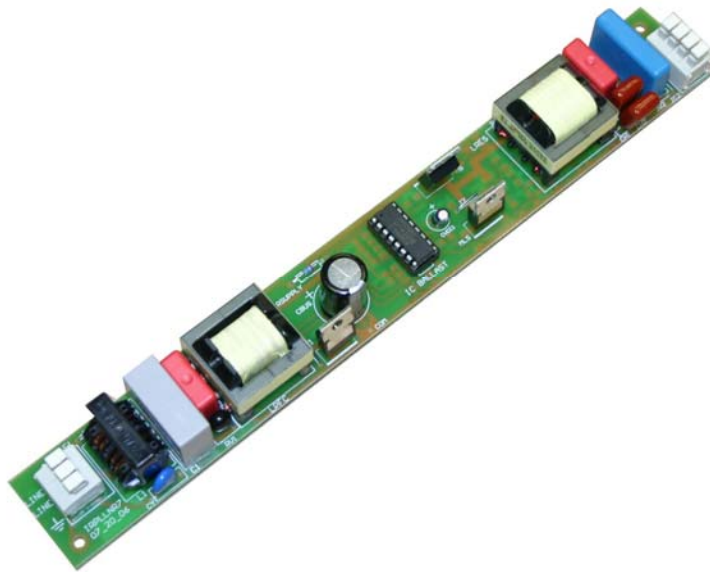

1. Description

The IRPLLNR7 Demo Board is a high efficiency, high power factor, fixed output electronic ballast designed for driving rapid start fluorescent lamp types. The design contains an EMI filter, active power factor correction and a ballast control circuit using the IRS2166D(S)PbF Ballast Control IC¹. This demo board is intended to ease the evaluation of the IRS2166D, demonstrate PCB layout techniques and serve as an aid in the development of a production ballast using International Rectifier's IRS2166D.

2. Ballast Block Diagram

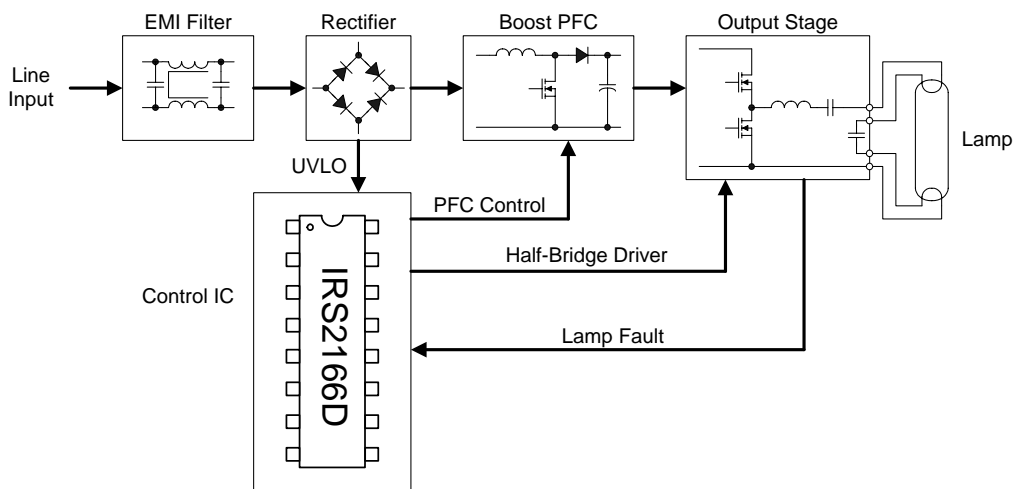

¹ For convenience, the “(S)PbF” extension of IRS2166D(S)PbF will be removed in the rest of this document

3. Electrical Characteristics

Parameter	Units	Value
Lamp Type		35 W TL5
Input Power	[W]	38
Lamp running voltage	[Vpp]	690
Run Mode Frequency	[kHz]	45
Preheat Mode Frequency	[kHz]	60
Preheat Time	[s]	1
Lamp Preheat Voltage	[Vpp]	600
Ignition Voltage	[Vpp]	1600
Input AC Voltage Range	[VACrms]	80-260 VAC
Power Factor		0.995 at 120 VAC (rms) 0.971 at 220 VAC (rms)
Total Harmonic Distortion	[%]	<10 at 120 VAC (rms) <15 at 220 VAC (rms)

4. Fault Protection Characteristics

Fault	Ballast	Restart Operation
Line voltage low	Deactivates	Increase line voltage
Upper filament broken	Deactivates	Lamp exchange
Lower filament broken	Deactivates	Lamp exchange
Failure to ignite	Deactivates	Lamp exchange
Open circuit (no lamp)	Deactivates	Lamp exchange
End of life	Deactivates	Lamp exchange

5. Overview

The IRPLLNR7 Demo Board consists of an EMI filter, an active power factor correction section, a ballast control section and a resonant lamp output stage. The active power factor correction section is a boost converter operating in critical conduction mode, free-running frequency mode. The ballast control section provides frequency modulation control of a traditional RCL lamp resonant output circuit and is easily adaptable to a wide variety of lamp types. The ballast control section also provides the necessary circuitry to perform lamp fault detection, shutdown and auto-restart.

6. Schematic Diagram:
 IRS2166D, Single Lamp, Voltage Mode Heating

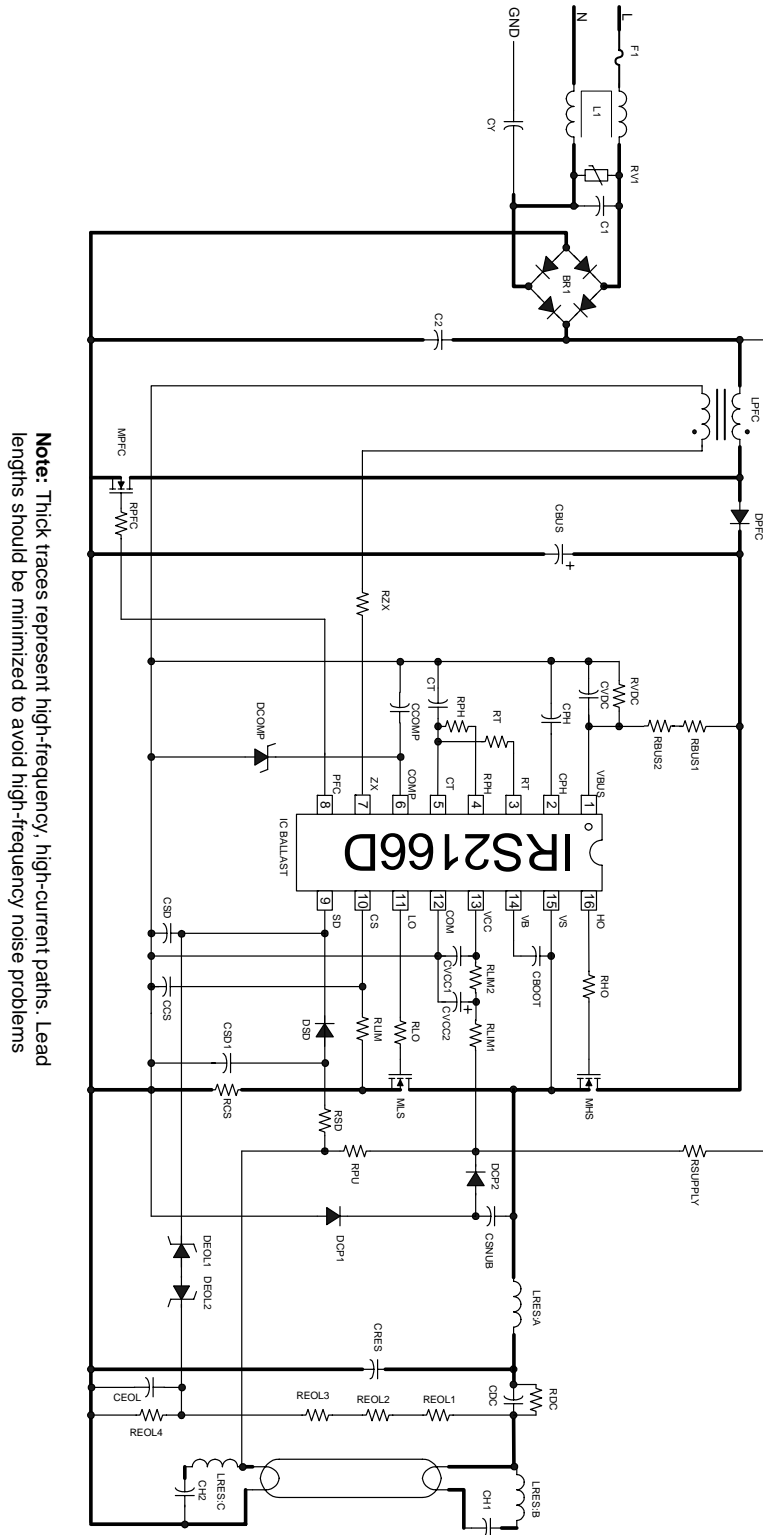

Note: Thick traces represent high-frequency, high-current paths. Lead lengths should be minimized to avoid high-frequency noise problems

7. PCB Layout and Component Placement Diagram

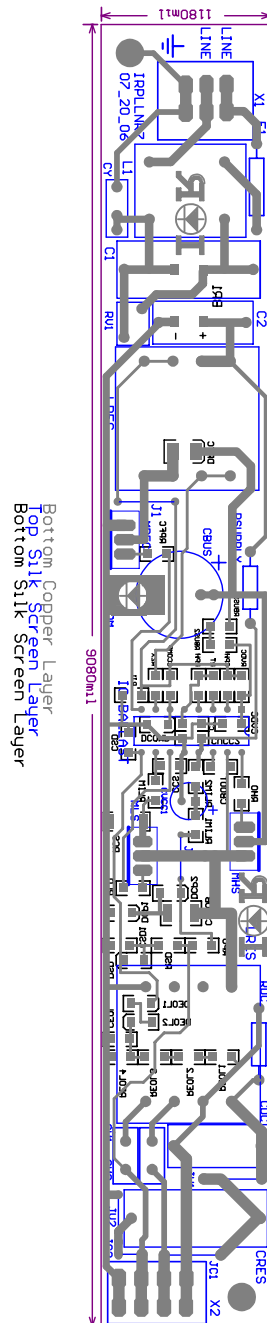

8. Bill Of Materials

Note: Different lamp types require different frequency programming components.

Item #	Qty	Manufacturer	Part Number	Description	Reference
1	1	International Rectifier	DF10S	Bridge Rectifier, 1A 1000V	BR1
2	1	Roederstein	WY0222MCMBF0K	Capacitor, 2.2nF 275 VAC Y Cap	CY
3	1	Dale	CW-1/2	Resistor, 0.5 ohm, 1/2W	F1
4	1	Roederstein	F1772433-2200	Capacitor, 0.33uF 275 VAC	C1
5	1	Panasonic	ELF-15N007A	EMI Inductor, 1X10mH 0.7Apk	L1
6	2	Wima	MKP10	Capacitor, 0.1uF 400 VDC	C2, CDC,
7	1	Panasonic	ERZ-V05D471	Transient Suppressor	RV1
8	1	Panasonic		Capacitor, 10uF 450VDC 105C	CBUS
9	1	B.I. Technologies	HM00-01761	PFC Inductor, 1.0mH 3Apk	LPFC
10	2	Panasonic	ECJ-2VB1HC104K	Capacitor, 0.1uF SMT 1206	CBOOT, CVCC2
11	1	Panasonic	ECU-V1H473KBM	Capacitor, 0.47uF SMT 1206	CPH
12	2	Panasonic	ECU-V1H102JCH	Capacitor, 1nF SMT 1206	CSD, CEOL
13	1	Panasonic	ECU-V1H333KBM	Capacitor, 0.33uF SMT 1206	CSD1
14	1	Panasonic	ECU-V1H103KBM	Capacitor, 0.01uF SMT 1206	CVDC
15	1	Panasonic	ECE-A1HGE02R2	Capacitor, 2.2uF 50VDC 105C	CVCC1
16	1	Panasonic	ECJ-3YB1E105K	Capacitor, 1.0uF SMT 1206	CCOMP
17	1	Johanson Dielectrics	102R29W821KV4E	Capacitor, 820pF 1KV SMT 1812	CSNUB
18	1	WIMA	FKP1-3300/2000/5	Capacitor, 3.3nF 2KV	CRES
19	1	Panasonic	ECU-V1H221KBM	Capacitor, 220pF SMT 1206	CCS
20	2	Panasonic	ECQB1104JFW	Capacitor, 0.1uF 100V	CH1, CH2
21	1	Panasonic	ECU-V1H821KBN	Capacitor, 820pF SMT 1206	CT
22	1	Digi-key	MURS160DICT-ND	Diode, 1A 600V, SMT SMB	DPFC
23	3	Diodes	LL4148DICT-ND	Diode, 1N4148 SMT DL35	DCP1, DCP2, DSD
24	1			Diode, 11V Zener, SMT 1206	DCOMP
25	1	International Rectifier	IRS2166D	IC, Ballast + PFC Control	IC BALLAST
26	1	B.I. Technologies	HM00-01762	Inductor, 4.0mH 3Apk	LRES
27	3	International Rectifier	IRF830	Transistor, MOSFET	MPFC, MHS, MLS
28	3	Panasonic	ERJ-8GEYJ22	Resistor, 22 ohm SMT 1206	RPFC, RLO, RHO
29	1	Panasonic	ERJ-6ENF5902V	Resistor, 59K ohm 1% SMT1206	RPH
30	1	Phoenix Passive Components	5033ED220K0F12AF5	Resistor, 220K ohm 1/2W	RSUPPLY
31	2	Panasonic	ERJ-8GEYJ680K	Resistor, 680K ohm SMT 1206	RBUS1, RBUS2
32	1	Panasonic	ERJ-6ENF2202V	Resistor, 22K ohm 1% SMT 1206	RT
33	1	Panasonic	ERJ-8GEYJ1K	Resistor, 1K ohm SMT 1206	RLIM
34	2	Panasonic	ERJ-8GEYJ10	Resistor, 10 ohm SMT 1206	RLIM1, RLIM2
35	1	Panasonic	ERJ-12RQF1R5U	Resistor, 1.5 ohm 1% SMT 2010	RCS
36	1	Panasonic	ERJ-8GEYJ223V	Resistor, 22K ohm SMT 1206	RZX
37	1	Panasonic	ERJ-6ENF1302V	Resistor, 13K ohm 1% SMT 1206	RVDC
38	1			Resistor, 100K ohm 1/2W	RDC
39	1	Panasonic	ERJ-8GEYJ104V	Resistor, 100K ohm SMT 1206	RSD
40	3	Panasonic	ERJ-8GEYJ224V	Resistor, 220K ohm SMT 1206	REOL1, REOL2, REOL3
41	1	Panasonic	ERJ-8GEYJ333V	Resistor, 20K ohm SMT 1206	REOL4
42	1			Diode, 10V Zener SMT 1206	DEOL1
43	1			Diode, 5.6V Zener SMT 1206	DEOL2
44	1	Panasonic	ERJ-8GEYJ105V	Resistor, 1meg ohm SMT 1206	RPU
45	1	Panasonic	ERJ-8GEYJR00V	Resistor, 0 ohm SMT 1206	RJ1
46	4			Wire Jumper	J1, J2, JV1, JV2
47	1	WAGO	235-203	Connector, 3 terminal	X1
48	1	WAGO	235-207	Connector, 4 terminal	X2
Total	65				

9. Inductor Specifications (PFC Inductor)



INDUCTOR SPECIFICATION

TYPE : LPFC

CORE SIZE

E25/13/7 (EF25)

GAP LENGTH

1

mm

BOBBIN

HORIZONTAL

PINS

8

CORE MATERIAL

Philips 3C85, Siemens N27 or equivalent

NOMINAL INDUCTANCE

1

mH

MAXIMUM CURRENT

2

A_{pk}

MAXIMUM CORE TEMPERATURE

100

°C

WINDING	START PIN	FINISH PIN	TURNS	WIRE DIAMETER (mm)
MAIN	1	6	125	4 strands of AWG 32
ZX	3	8	10	4 strands of AWG 32

ELECTRICAL LAYOUT

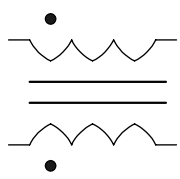

PHYSICAL LAYOUT

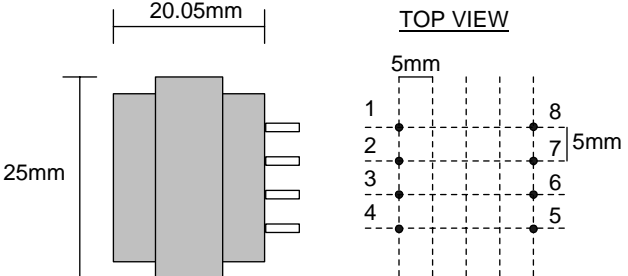

TEST (TEST FREQUENCY = 50kHz)

MAIN WINDING INDUCTANCE

MIN 0.9

mH

MAX 1.1

mH

MAIN WINDING RESISTANCE

MAX 1.5

Ohms

NOTE : Inductor must not saturate at maximum current and maximum core temperature at given test frequency.

10. Inductor Specifications (Resonant Inductor)

International
IR Rectifier

INDUCTOR SPECIFICATION

TYPE : LRES(VOLTAGE MODE)

CORE SIZE GAP LENGTH mm
 BOBBIN PINS
 CORE MATERIAL
 NOMINAL INDUCTANCE mH
 MAXIMUM CURRENT Apk
 MAXIMUM CORE TEMPERATURE °C

WINDING	START PIN	FINISH PIN	TURNS	WIRE DIAMETER (mm)
MAIN	1	8	250	4 strands of AWG 32
CATHODE (1)	6	7	10	4 strands of AWG 32
CATHODE (2)	4	5	10	4 strands of AWG 32

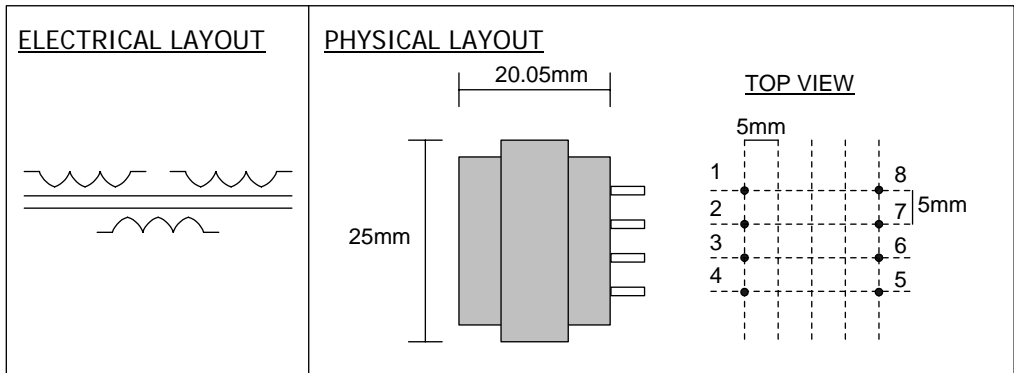

TEST (TEST FREQUENCY = 50kHz)

MAIN WINDING INDUCTANCE mH mH

MAIN WINDING RESISTANCE Ohms

NOTE : Inductor must not saturate at maximum current and maximum core temperature at given test frequency.

11. Demo Board Overview

This demo-board is designed for single TL5/35W Lamp, voltage mode heating (JV1 and JV2 mounted, JC1 and JC2 not mounted). TL5 lamps are becoming more popular due to their lower profile and higher lumen/ watt output. These lamps, however, can be more difficult to control due to their higher ignition and running voltages. A typical ballast output stage using current-mode filament heating (filament placed inside L-C tank) will result in excessive filament current during running. The output stage has therefore been configured for voltage-mode filament heating using secondary windings off of the resonant inductor LRES. The lamp has been placed outside the under-damped resonant circuit loop, which consist of LRES and CRES. The filament heating during preheat can be adjusted with the capacitors CH1 and CH2. The result is a more flexible ballast output stage necessary for fulfilling the lamp requirements. The DC blocking capacitor, CDC, is also placed outside the under-damped resonant circuit loop such that it does not influence the natural resonance frequency of LRES and CRES. The snubber capacitor, CSNUB, serves as charge pump for supplying the IRS2166D.

The IRS2166D Ballast Control IC is used to program the ballast operating points and protect the ballast against conditions such as lamp strike failures, low DC bus, thermal overload or lamp failure during normal operations. It is also used to regulate the DC bus and for power factor control allowing high power factor and low harmonic distortion.

12. Power Factor Correction Section

The power factor correction section contained in the IRS2166D forms the control for a boost topology circuit operating in critical conduction mode. This topology is designed to step-up and regulate the output DC bus voltage while drawing sinusoidal current from the line (low THD) which is “in phase” with the AC input line voltage (HPF).

13. Ballast Control Section

The ballast control section of the IRS2166D Ballast Control IC contains an oscillator, a high voltage half-bridge gate driver and lamp fault protection circuitry. Please, refer to the datasheet of this IC for the block diagram and the state diagram. The following is a breakdown of the operation of the ballast in all of the different modes of operation.

14. Startup Mode

When power is initially applied to the ballast, the voltage on the VCC pin of the IRS2166D begins to charge up. The voltage for the IRS2166D is derived from the current supplied from the rectified AC line through startup resistor RSUPPLY. During this initial startup when the VCC voltage of the IRS2166D is below its rising under-voltage lock-out threshold, it is in UVLO mode and draws micro-power current from VCC. The micro-power current of the IRS2166D allows the use of a large value, low wattage startup resistor (RSUPPLY). When the voltage on the IRS2166D reaches the rising under-voltage lockout threshold (12.5V), the gate driver oscillator is enabled (this assumes that there are no fault conditions) and drives the half-bridge output MOSFETs (MHS and MLS). When the half-bridge is oscillating, capacitor CSNUB, diodes DCP1 and DCP2 form a snubber /charge pump circuit which limits the rise and fall time at the half-bridge output and also supplies the current to charge capacitor CVCC2 to the VCC clamp voltage (approx. 15.6V) of IRS2166D. When the rising under-voltage lockout threshold of the IRS2166D is reached, the power factor control oscillator starts to oscillate and drive MOSFET MPFC to boost and regulate the bus voltage to 400 VDC.

15.Preheat Mode

When the ballast reaches the end of the UVLO mode, the Preheat mode is entered. At this point the ballast control oscillator of the IRS2166D has begun to operate and the half-bridge output is driving the resonant load (lamp) circuit. There is an initial startup frequency that is much higher than the steady state Preheat mode frequency that lasts for only a short duration. This is done to ensure that the initial voltage appearing across the lamp at the startup of oscillation does not exceed the minimum lamp ignition voltage. If, at the initiation of oscillation of the half-bridge, the voltage across the lamp is large enough, a visible flash of the lamp occurs which should be avoided. This in effect is a cold strike of the lamp, which could shorten the life of the lamp.

The ballast control section oscillator of the IRS2166D is similar to oscillators found in many popular PWM voltage regulator ICs and consists of a timing capacitor and resistor connected to ground. Resistors RT and RPH program a current that determines the ramp up time of capacitor CT. The downward ramping time of CT is the deadtime between the switching off of the LO (HO) and the switching on of the HO (LO) pins on the IRS2166D. The Preheat mode frequency of oscillation is determined from the parallel resistance of RT and RPH. It is selected such that the voltage appearing across the lamp is below the minimum lamp ignition voltage while supplying enough current to preheat the lamp filaments to the correct emission temperature within the Preheat mode period. The preheating of the lamp filaments is performed with a constant voltage during the Preheat mode. The waveform in Figure 2 shows the lamp filament current while Figure 3 shows lamp filament voltage during the normal Startup, Preheat, and Ignition Ramp modes of the ballast.

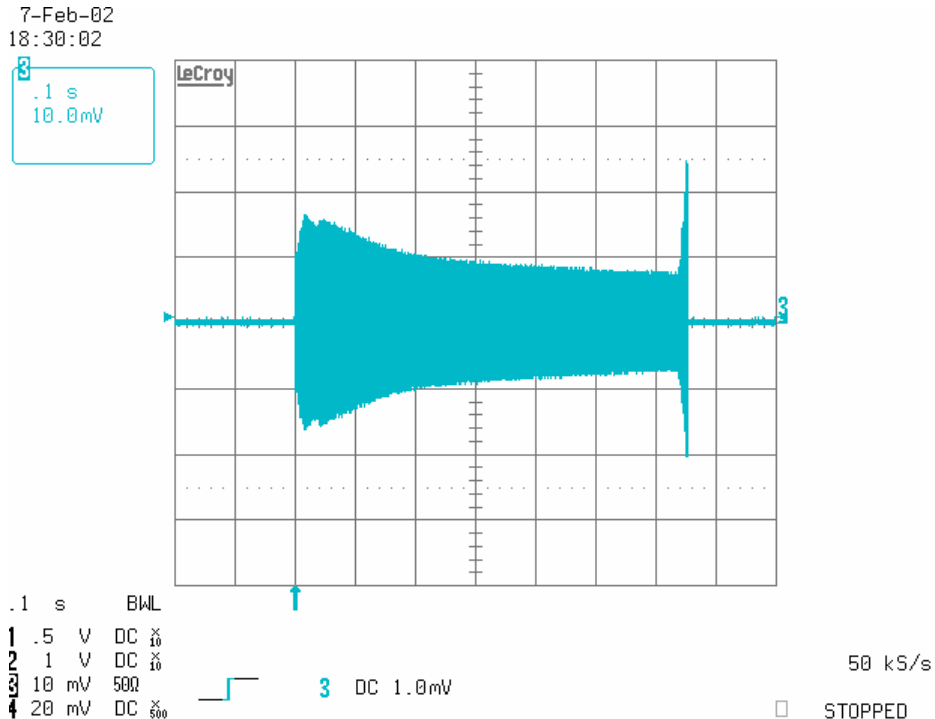

**Figure 2: Lamp filament current during Preheat and Ignition Ramp (500mA / div)
(Crossed lamps)**

7-Feb-02
18:27:23

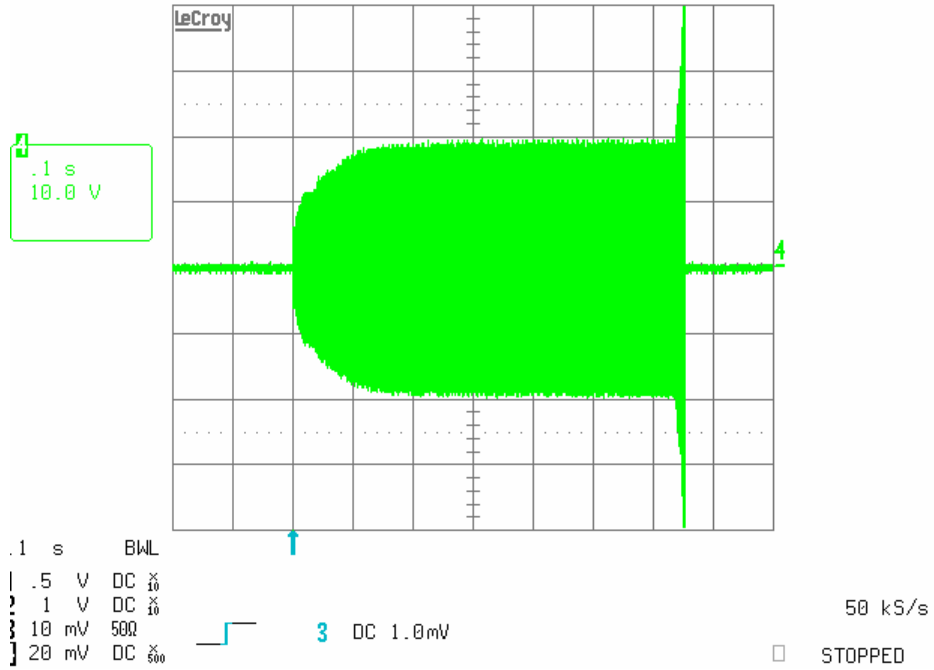

Figure 3: Lamp filament voltage during preheat and Ignition Ramp (Crossed lamps)

Figure 4 shows a plot of the half-bridge oscillation frequency as a function of time for all of the normal modes of operation: Preheat mode, Ignition Ramp mode and Run mode.

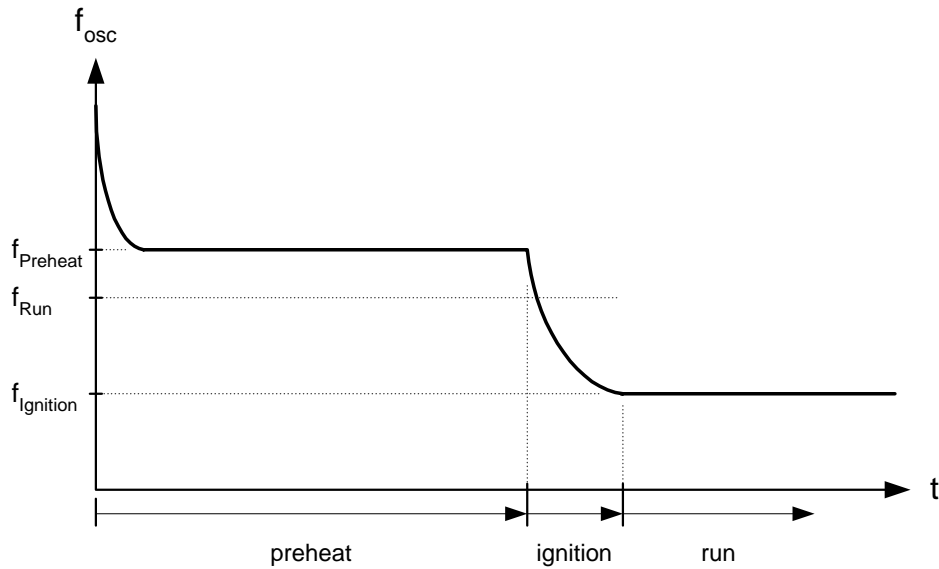

Figure 4: Oscillator frequency versus time, Normal operating conditions

The duration of the Preheat mode as well as the mode of operation of the ballast are determined by the voltage on the CPH pin of the IRS2166D. At the completion of the UVLO mode, Preheat mode is entered and an internal current source is activated at the CPH pin of the IR2166, which begins to charge up capacitor CPH. The ballast remains in the Preheat mode until the voltage on the CPH pin exceeds the Ignition Ramp mode threshold (10 V).

16. Ignition Ramp Mode

At the completion of the Preheat mode the ballast switches to the Ignition Ramp mode and the frequency ramps down to the run frequency. Resistor RPH is no longer connected directly in parallel with resistor RT so the run frequency is determined only with RT. During this ramping downward of the frequency, the voltage across the lamp increases in magnitude as the frequency approaches the resonant frequency of the LC load circuit until the lamp ignition voltage is exceeded and the lamp ignites. The maximum ignition voltage that can be generated is determined from the value of RCS, but in any case the ignition frequency must be higher than the run frequency. Figure 5 shows the ramping of voltage appearing across the lamp.

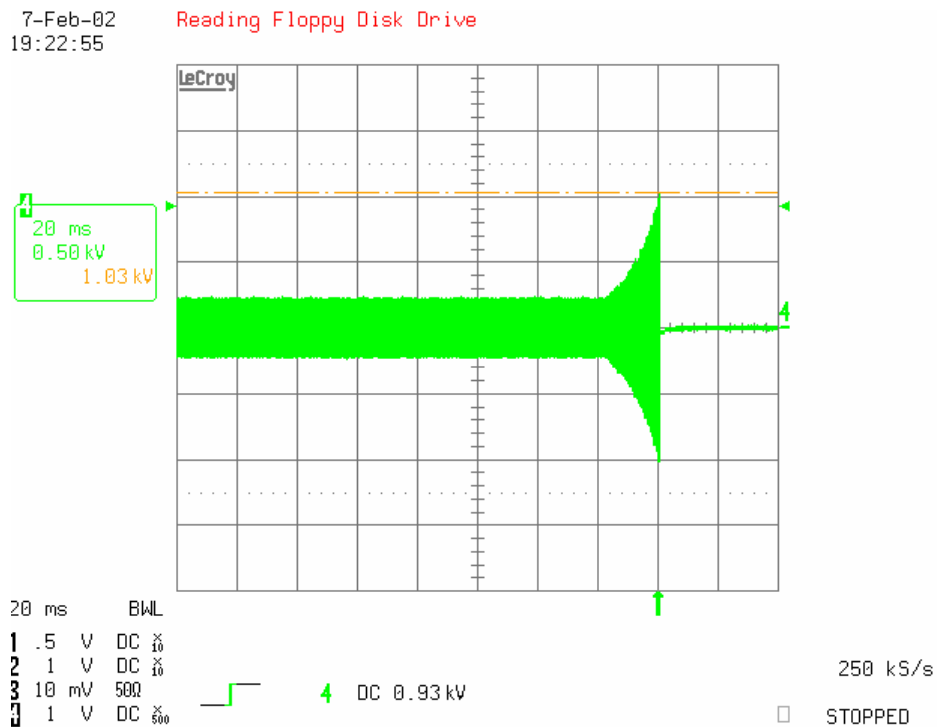

Fig. 5: Ignition ramp (crossed lamps)

During the Ignition Ramp mode the voltage on the CPH pin of the IRS2166D continues to ramp up until the voltage at the CPH pin of the IRS2166D exceeds the Run mode threshold (13 V). Over-current sensing and fault counter are enabled during Preheat and Ignition modes. A full explanation of the functionality of the over-current sensing is in the section on Fault Mode.

17.Run Mode

During the Run mode the frequency is shifted to the run frequency. The run frequency is determined only by RT. The 1 V to 3 V end-of-life window comparator in the SD pin is enabled at the beginning of the Run mode. The full explanation of the functionality of the end-of-life sensing is in the section on Fault Mode. The Run mode frequency is that at which the lamp is driven to the lamp manufacturer's recommended lamp power rating. The running frequency of the lamp resonant output stage for selected component values is defined as,

$$f_{run} = \frac{1}{2\pi} \sqrt{\frac{1}{LC} - 2\left(\frac{P_{Lamp}}{CV^2_{Lamp}}\right)^2} + \sqrt{\left[\frac{1}{LC} - 2\left(\frac{P_{Lamp}}{CV^2_{Lamp}}\right)^2\right]^2 - 4\frac{1 - \left(\frac{2V_{DCbus}}{V_{Lamp}\pi}\right)^2}{L^2 C^2}}$$

where,

L	= Lamp resonant circuit inductor (L3)	(H)
C	= Lamp resonant circuit capacitor (C14)	(F)
P_{Lamp}	= Lamp running power	(W)
V_{Lamp}	= Lamp running voltage amplitude	(V)

Figure 6 shows the voltage appearing across the lamp during Startup, Preheat, Ignition Ramp and Run modes.

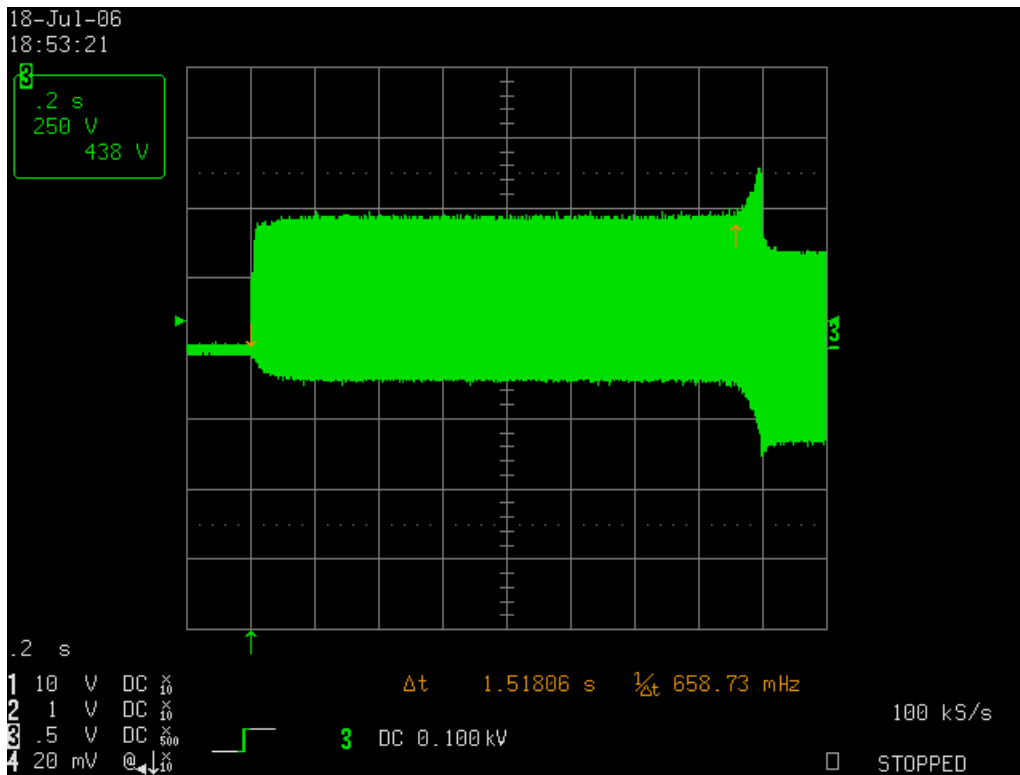

Fig. 6: Preheat, Ignition Ramp and Run Voltage in the lamp

18. Normal Power Down and Brown-Out Reset

A normal power down occurs when the AC line voltage is disconnected from the ballast. A brown-out condition occurs when the AC line is disconnected momentarily. When either of these conditions occurs, the COMP pin voltage gets limited by the zener diode DCOMP causing the PFC on-time to become limited and the voltage on the VBUS pin of the IRS2166D to drop below the undervoltage reset threshold (3 V). VCC will then be discharged below the power down threshold (UVLO-) and the ballast will go into UVLO mode. The ballast control oscillator is stopped, the half-bridge and PFC gate driver outputs (LO, HO and PFC) are turned off and the IRS2166D goes into its UVLO/micro-power mode and the bus voltage collapses. When the AC line returns, VCC will increase again above UVLO+ and the ballast will restart in Preheat mode.

19. Lamp Removal and Auto-Restart

When the lamp is removed, the SD pin will pull above the 5 V shutdown threshold via the external pull-up resistor RPU. The ballast will remain in a non-latched shutdown condition with LO, HO, and the PFC gate drive outputs off. When the lamp is re-inserted, the lower filament will pull the SD pin back below 3 V and the ballast will restart in Preheat mode.

20. Fault Mode

Fault mode is when the ballast driver is shutdown due to the detection of a lamp fault. Note that when the ballast is in this Fault mode the power factor correction section of the ballast is also shutdown and the bus voltage will drop to the non-boosted/unregulated level. There are several lamp fault conditions that can put the ballast into the Fault mode. The lamp fault conditions detected include: hard-switching detection, over-current detection (CS pin) and end-of-life or no load detection (SD pin). Resistor RCS in the source lead of the low-side MOSFET (MHS) serves as the current sensing point for the half-bridge, which is used to detect these lamp fault conditions. In operation when the half-bridge is oscillating, a voltage appears across RCS whenever the low-side MOSFET, MHS, is turned on or the high-side MOSFET, MLS, is turned off. The magnitude of this voltage directly relates to the current in the lamp resonant circuit. Figure 7 shows the voltage which appears across resistor RCS during normal Run mode conditions. Also shown in Figure 7 are the gate drive signals for the low-side MOSFET (LO pin) and the high-side MOSFET (HO-VS pin).

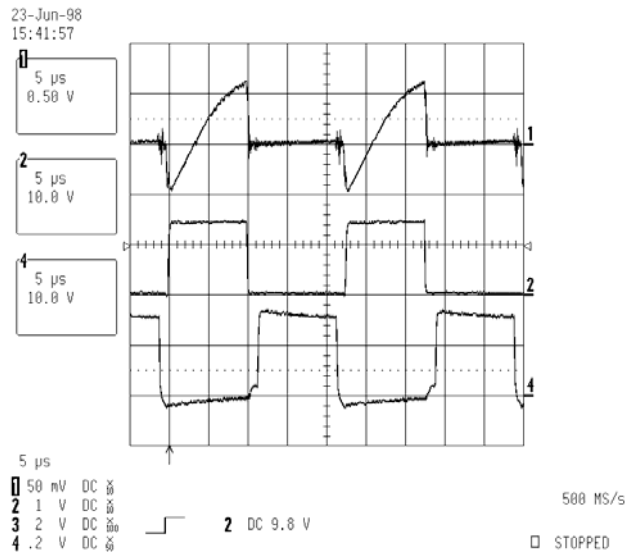

Figure 7: Normal Run mode; Upper trace: voltage across RCS, Middle trace: IC2 LO pin voltage, Lower trace: IC2 HO-VS pin voltage

During the Preheat and Ignition modes the over-current threshold at the CS pin and internal fault counter are enabled. During Run mode the fault counter is disabled. If at any time thereafter the voltage magnitude across resistor RCS rises above the over-current threshold (1.3 V) for a single event, a lamp fault condition is signaled and the half-bridge output MOSFETs', (MHS and MLS) are turned off and the ballast goes into Fault mode. During Preheat and Ignition, a lamp fault condition is signaled only after 25 cycles to avoid triggering this protection in the case of a current transient that can happen during normal ignition. An over-current condition can occur if the lamp fails to ignite or the lamp is broken (an open circuit cathode or broken lamp). Figure 8 shows the voltage across resistor RCS and the voltage at the half-bridge (VS pin) when the ballast detects a failure to ignite the lamp and goes into Fault mode. Figure 9 shows the voltage appearing across the lamp during the tail end of the Preheat mode and the Ignition Ramp mode for a failure of the lamp to ignite condition. If a cathode is broken (open circuit) the half-bridge output hard-switches and each time the low-side MOSFET (MHS) is turned on a large current pulse occurs and thus a large voltage pulse occurs across resistor RCS signaling a fault, Figure 10 shows this hard-switching condition. The ballast will remain in Fault mode until either the line voltage is reset or a lamp replacement is performed.

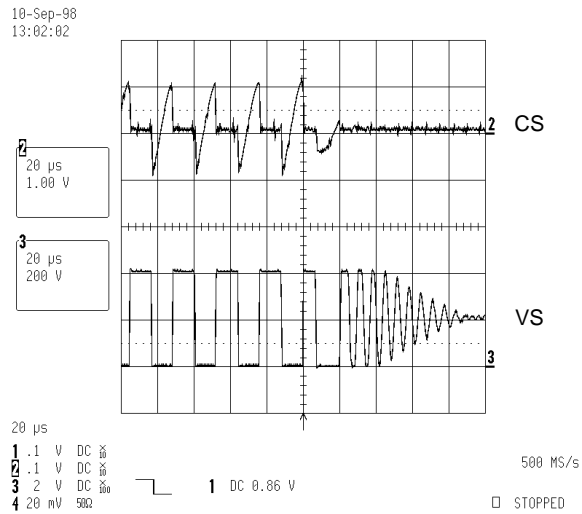

Figure 8: Failure of lamp to ignite condition (lamp filaments good): Upper trace: voltage across RCS, Lower trace: voltage at VS pin

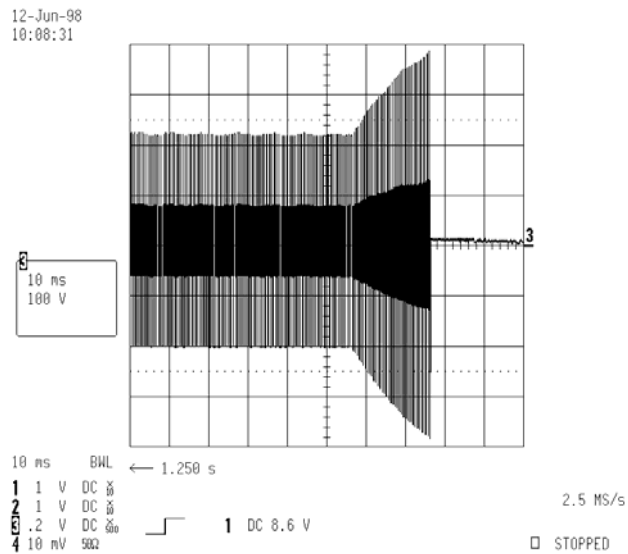

Figure 9: Failure of lamp to ignite condition (lamp filaments good): Lamp voltage during end of Preheat and Ignition Ramp modes

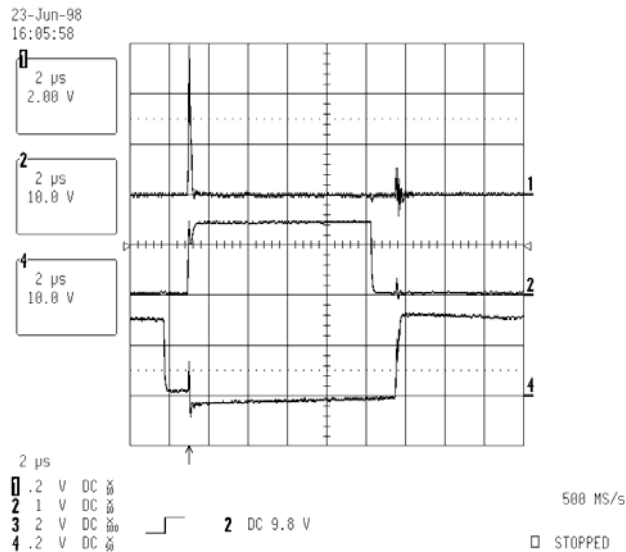

Figure 10: Hard-switching condition (upper filament open): Upper trace: voltage across RCS, Middle trace: IC2 LO pin voltage, Lower trace: IC2 HO-VS pin voltage

During an end-of-life lamp fault condition, the lamp voltage can increase or decrease asymmetrically. The resulting excessive voltage across the lamp filaments can cause the lamp ends to reach temperatures high enough to melt the tube glass. The lamp can then fall out of the fixture and cause harm or damage. To protect against this condition, resistors REOL1, REOL2, REOL3, REOL4, and zener diodes DEOL1 and DEOL2, are used for end-of-life protection. The end-of-life window comparator at the SD/EOL pin is enabled in Run Mode. If the voltage on SD/EOL pin falls outside the range of the internal 1 V to 3 V window comparator, the IC will enter Fault Mode. The SD/EOL pin is internally biased at 2 V with an internal +/-10 μ A OTA. The value of REOL4, DEOL1 and DEOL2 are selected such that the SD/EOL pin remains at 2 V during normal operation, but increases above 3 V or decreases below 1 V during an end-of-life fault condition. The lamp voltage end-of-life threshold can be adjusted by changing the value of resistor REOL4 and/or zener diodes DEOL1 and DEOL2 (a threshold of 30% higher than the nominal running lamp voltage is typical).

21. Current Mode Configuration

The same PCB can be configured for current mode heating. It is needed to remove the Jumpers JV1 and JV2 and to introduce the Jumpers JC1 and JC2. It could be also useful to add a resistor RDC in parallel to CDC because in this configuration striations (visible dark rings) on the lamps can occur particularly when the lamp has been off for some time and is cold. The value should be in the order of 100 k Ω 0.5 W.

We suggest the use of the Ballast Designer software to determine the values of the components to use in this configuration.

22.Design Procedure for Different Lamp Types

To adapt the design to different types of lamps you need to adjust the values of: LPFC, MPFC, MLO, MHO, CPH, RT, RPH, RCS, CT, REOL4, CRES, and LRES. Do not change any others values!

- 1) Use the Ballast Designer Software V4.0 (visit IR website to download) to set the values of LRES, CRES, LPFC, MPFC, MLO and MHO, CT, and to set the starting values of CPH, RT, RPH, RCS and LPFC.

Cross both lamps (i.e. connect a filament or resistor to each lamp cathode position but not a good lamp) and measure the lamp voltage at ignition using a storage oscilloscope.

- 1) Set RCS to get the right maximum ignition voltage (decrease RCS to increase the ignition voltage)
Cross both lamps (i.e. connect a filament or resistor to each lamp cathode position but not a good lamp) and measure the lamp voltage at ignition using a storage oscilloscope.

Connect both lamps correctly and measure the input power

- 2) Set RT to set the power on the lamp (increase RT to decrease the frequency and increase the power on the lamp)
- 3) Set RPH to set the right preheat frequency (increase RPH to decrease the preheat frequency and increase the preheat current)

In the case of voltage mode heating, increase CH1 and CH2 to increase the preheat voltage (use 6-7 turns in the secondary of LRES).

- 4) Select CPH to set the preheat time (increase CPH to increase the preheat time)
- 5) Verify the value of LPFC at each limit of the line/load range:

Maximum input voltage:

If the COMP pin becomes less than 400 mV the PFC will not operate in a stable manner and it is necessary to increase LPFC.

Minimum input voltage:

If the PFC does not operate in a stable manner and audible noise can be heard from LPFC, it is necessary to decrease LPFC.

- 6) Set REOL4 to set the end-of-life protection to a percentage of the lamp voltage. For example, to set the protection threshold to 30% of the lamp voltage:

The value of REOL4 is chosen to have the SD pin varying between $2-0.7$ V and $2+0.7$ V during normal operations and exceeding the window comparator limits (less than 1 V or more than 3 V) with 30% change in the voltage of the lamp.

(Fine tuning of this threshold can be done by trying different REOL4 values on the test bench)