



AMPROBE®

DM-4 Power Quality Recorder



TABLE OF CONTENTS

1. PRECAUTIONS AND SAFETY MEASURES	3
1.1 GENERAL.....	3
1.2 PRELIMINARY INSTRUCTIONS.....	3
1.3 DURING USE.....	4
1.4 AFTER USE.....	4
2. GENERAL DESCRIPTION	5
2.1 INTRODUCTION.....	5
2.2 FUNCTIONS.....	5
3. PREPARING THE INSTRUMENT	6
3.1 INITIAL CHECK.....	6
3.2 INSTRUMENT POWER SUPPLY.....	6
3.3 CALIBRATION.....	6
3.4 STORAGE.....	7
4. HOW TO OPERATE	7
4.1 INSTRUMENT: DESCRIPTION.....	7
4.2 KEYBOARD: DESCRIPTION.....	7
4.3 USING THE DM-4 WITH THE REMOTE USER INTERFACE (PDA).....	8
4.4 DISPLAY DESCRIPTION OF THE REMOTE USER INTERFACE (PDA).....	9
4.4.1 VIEW REAL TIME DATA.....	9
4.4.2 SETUP A NEW RECORDING SESSION.....	13
4.4.3 SET DATE AND TIME FOR AUTOMATIC RECORDING SESSION.....	14
5. MAIN MENU	15
5.1 INITIAL SETTINGS.....	15
5.1.1 HOW TO SET THE DATE AND TIME?.....	16
5.2 DEFAULT SETTINGS: ANALYZER CONFIG.....	16
5.2.1 HOW TO SET THE TYPE OF ELECTRICAL SYSTEM UNDER TEST.....	17
5.3 BASIC SETTING: RECORDER CONFIG.....	18
5.3.1 MDL PARAMETER SETUP.....	18
5.3.2 MDL VOLTAGE ANOMALIES.....	18
5.4 ADVANCED SETTING: RECORDER CONFIGURATION.....	19
5.4.1 SETTING THE PARAMETERS INDIVIDUALLY.....	20
5.4.2 ADVANCED MDL PARAMETER SETUP.....	20
5.4.3 SET UP THE PARAMETERS FOR VOLTAGE.....	20
5.4.4 SETUP THE PARAMETERS FOR CURRENT.....	21
5.4.5 SETUP THE PARAMETERS FOR POWER.....	21
5.4.6 SETUP THE PARAMETERS FOR VOLTAGE HARMONICS.....	22
5.4.7 SETUP THE PARAMETERS FOR CURRENT HARMONICS.....	23
5.5 DOWNLOAD DATA.....	24
5.5.1 DOWNLOAD DATA WITH THE REMOTE USER INTERFACE (PDA).....	24
5.5.2 VIEW DOWNLOADED DATA.....	25
5.5.3 RECORDING INFORMATION.....	25
5.5.4 DELETE SESSION.....	26
5.5.5 RESET.....	29
6. RECORDING CONFIGURATION	30
7. STARTING A RECORDING	30

8. RECORDING IN PROCESS	32
9. STOPPING A RECORDING	33
9.1 STOP A RECORDING WITH THE REMOTE USER INTERFACE (PDA).....	33
9.2 STOP A RECORDING WITH THE DOWNLOAD SUITE.....	33
10. CONNECTING THE INSTRUMENT TO A PC	34
11. MEASURING PROCEDURES	35
11.1 USING THE INSTRUMENT IN A SINGLE PHASE SYSTEM.....	35
11.2 USING THE INSTRUMENT IN A THREE PHASE 4- WIRE SYSTEM (WYE).....	36
11.3 USING THE INSTRUMENT IN A THREE PHASE 3- WIRE SYSTEM (DELTA).....	38
12. MAINTENANCE	40
12.1 GENERAL.....	40
12.2 BATTERY REPLACEMENT.....	40
13. TECHNICAL SPECIFICATIONS	41
13.1 FEATURES.....	41
13.1.1 VOLTAGE MEASUREMENT.....	41
13.1.2 VOLTAGE ANOMALIES DETECTION (MANUAL SELECTION OF RANGE) VOLTAGE.....	41
13.1.3 CURRENT MEASUREMENT (USING EXTERNAL TRANSDUCER).....	41
13.1.4 POWER MEASUREMENT (COS θ : 0.5C – 0.5I).....	42
13.1.5 COS θ MEASUREMENT.....	42
13.1.6 MEASUREMENT OF HARMONICS.....	43
13.1.7 TEMPERATURE DRIFT.....	43
13.1.8 SAFETY.....	43
13.1.9 GENERAL CHARACTERISTICS.....	44
13.2 ENVIRONMENT.....	44
13.2.1 OPERATING CONDITIONS.....	44
13.3 ACCESSORIES.....	45
13.3.1 STANDARD ACCESSORIES.....	45
14. APPENDIX 1 – RECORDABLE PARAMETERS: SYMBOLS	46
15. APPENDIX 2 – THEORETICAL OUTLINES	47
15.1 VOLTAGE ANOMALIES (VOLTAGE SAG AND SURGE; SPIKE).....	47
15.2 VOLTAGE AND CURRENT HARMONICS.....	48
15.2.1 THEORY.....	48
15.2.2 LIMIT VALUES FOR HARMONICS.....	49
15.2.3 PRESENCE OF HARMONICS: CAUSES.....	50
15.2.4 PRESENCE OF HARMONICS: CONSEQUENCES.....	50
15.3 POWER AND POWER FACTOR: DEFINITIONS.....	51
15.3.1 CONVENTIONS ON POWERS AND POWER FACTORS.....	53
15.3.2 3 PHASE 3 WIRE SYSTEM.....	54
15.4 MEASURING METHOD: OUTLINES.....	55
15.4.1 INTEGRATION PERIODS.....	55
15.4.2 POWER FACTOR CALCULATIONS.....	55
16. AFTER-SALE SERVICE	56
16.1 WARRANTY.....	56
16.2 SERVICE.....	56

1. PRECAUTIONS AND SAFETY MEASURES

1.1 GENERAL

For your own safety and to avoid damaging the instrument we suggest you follow the procedures hereby prescribed and to carefully read all the notes preceded by the symbol .

Before and during measurements please be very diligent in following instructions below:

- Do not measure voltage or current in wet or dusty places
- Do not measure in presence of gas, explosive materials or combustibles
- Do not touch the circuit under test if no measurement is being taken
- Do not touch exposed metal parts, unused terminals, circuits and so on
- Do not use the instrument if it seems to be malfunctioning
- Use only cables and accessories approved by Amprobe

The following symbols are used in this manual:



Caution: keep to what is prescribed by the manual. An incorrect use could damage the instrument or its components



High voltage: risk of electric shock

1.2 PRELIMINARY INSTRUCTIONS

- This instrument has been designed for use in places with pollution class 2.
- It can be used for **voltage and current** measurements in installations of excess voltage category III 600 V~ phase to phase / 346 V~ phase to earth and of excess voltage category II 1000 V~ phase to phase / 577 V~ phase to earth.

- Please keep to the usual safety standards aimed at:
 - Protecting against dangerous currents;
 - Protecting the instrument against incorrect operations.
- Only the accessories supplied with the instrument guarantee compliance with the safety standards. Accordingly, they must be in good condition and, if necessary, they must be replaced with identical models.
- Do not take measurements on circuits exceeding the specified current and voltage limits.
- Before connecting voltage leads and clamps to the circuit under test, make sure that the circuit configuration has been selected.

1.3 DURING USE

Please read carefully:



CAUTION

Should you fail to keep to the prescribed instructions you could damage the instrument and/or its components or endanger your safety.

- When the instrument is connected to the circuit under test, do not touch any unused terminal.
- When measuring current, other currents located near the leads may affect the measuring accuracy.
- When measuring current, always position the wire in the very middle of the jaws in order to obtain the highest accuracy.

1.4 AFTER USE

- After use, turn off the instrument by pressing the ON/OFF push button.
- If you won't be using the instrument for long periods of time, use the storage instructions described in paragraph 3.4.

2. GENERAL DESCRIPTION

2.1 INTRODUCTION

The DM-4 also referred to as the Modular Data Logger (MDL), addresses the needs of the most demanding Power Quality professionals. The device incorporates full set of measuring features crucial for complete Power Quality analysis. An innovative Remote User Interface (PDA) allows safe, easy and convenient operation of the device remotely. Remote User Interface (PDA) is also used for data viewing, analysis and transfer. Independently, the DM-4 can be used directly with a PC using Download Suite software. Since the DM-4 does not have any control buttons on its enclosure, it is protected against setup changes by unauthorized persons while the device is recording, eliminating the need for password protection.

2.2 FUNCTIONS

The DM-4 is able to:

- **Display in real time** the electrical parameters of a single phase, two phase or three-phase system (wye or delta) and the harmonic analysis of voltages and currents.
- **Conduct a direct Energy measurement.**
- **Record simultaneously** (pressing the RECORD key after a proper connection & device configuration): RMS values of voltages, currents, corresponding harmonics; active, reactive and apparent powers, power factor and $\cos\Theta$; active, reactive and apparent energies; voltage sag and surge with 14ms resolution; and voltage spike with 100ns resolution. **It will be possible to analyze the recorded data by downloading the file using the Remote User Interface (PDA) or Download Suite.**
- **Record Data** (pressing RECORD key) the sampled values of the Parameters present at the instrument's input. **It will be possible to analyze the recorded data by downloading the file with the Remote User Interface (PDA) device or a PC using the Download Suite.**

3. PREPARING THE INSTRUMENT

3.1 INITIAL CHECK

This instrument has been checked before shipment from an electrical and mechanical point of view. All possible precautions have been taken in order to deliver it in perfect condition. Notwithstanding, on receipt of the instrument we suggest that you check it summarily to make sure that no damage has occurred in transit. Should you find irregularities, please contact the carrier immediately. Furthermore, make sure that the parcel contains all the accessories and parts listed on Table 13.3.1. In case of discrepancies, please contact your dealer. Should it be necessary to return the instrument to the supplier, please keep to the instructions given at paragraph 16.1.

3.2 INSTRUMENT POWER SUPPLY

The instrument can be powered by:

- 8 batteries 1.5V AA located in the compartment on the back of the instrument
- An external power supply code DM-4EXTPS supplied with the instrument (standard accessory).



CAUTION

For recordings **ALWAYS** use the external power supply (even though the instrument allows the operator to perform a recording using internal batteries).

3.3 CALIBRATION

The instrument complies with the standards mentioned in this manual. Its performance is guaranteed for one year from the purchase date.

3.4 STORAGE

For long time storage, please remove batteries to prevent leakage into the unit. Store unit in a safe location with room temperature conditions. To guarantee accurate measurements after a long storage period in severe environmental conditions, wait until the instrument resumes its normal conditions (see environmental conditions listed in paragraph 13.2).

4. HOW TO OPERATE

4.1 INSTRUMENT: DESCRIPTION

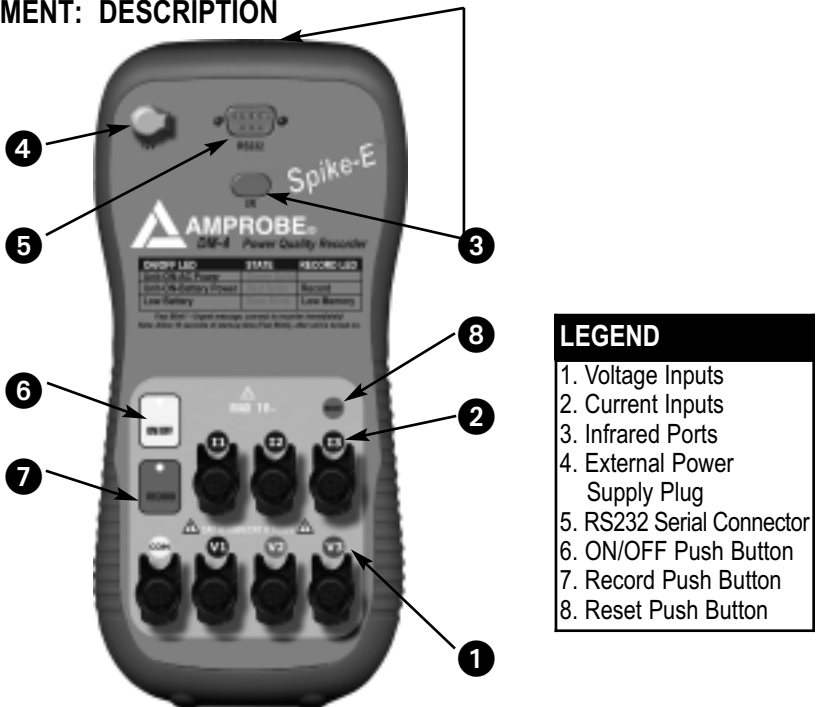

LEGEND	
1.	Voltage Inputs
2.	Current Inputs
3.	Infrared Ports
4.	External Power Supply Plug
5.	RS232 Serial Connector
6.	ON/OFF Push Button
7.	Record Push Button
8.	Reset Push Button

4.2 KEYBOARD: DESCRIPTION

The following keys are available:

ON/OFF: turning on – turning off / (Green LED for AC and Red LED for Battery)

RECORD: to start/stop manually a recording

RESET: to reset the unit

4.3 USING THE DM-4 WITH THE REMOTE USER INTERFACE (PDA)

- Connect the Remote User Interface (PDA) to the DM-4 using the provided cable
- Turn ON the DM-4 by pressing on the ON/OFF push button
- Turn ON the Remote User Interface (PDA) by pressing the power button
- Click on the MDL (Modular Data Logger) icon

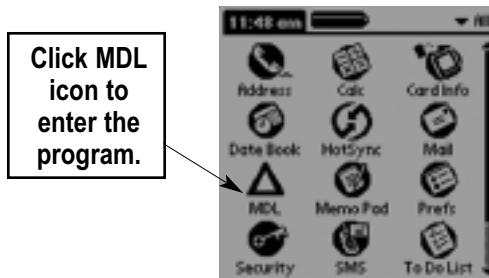

4.4 DISPLAY DESCRIPTION OF THE REMOTE USER INTERFACE (PDA)

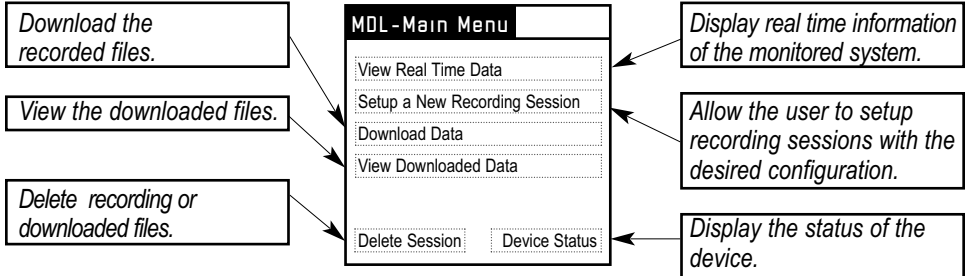

4.4.1 View Real Time Data

When monitoring an electrical system in real time, the user needs to know the type of system configuration the device is hooked up to in order to have the correct readings. Refer to section 11 for more information on the different types of electrical system configurations.

- From the MDL Main Menu screen, click on View Real Time Data. The following screen will appear.

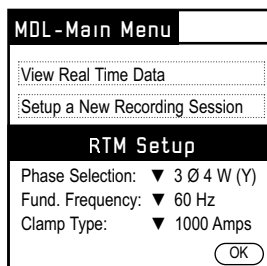

- Select the desired electrical system configuration you want to monitor.
- Select the fundamental frequency of the system
- Select the type of clamp you are using with the DM-4 to monitor the electrical system.
- Click OK to accept the system setup.

• **1-Phase 2-wire, 60Hz System using 1000A clamp**

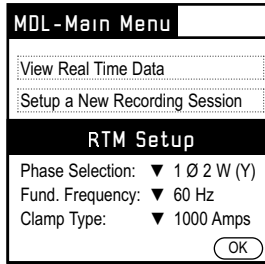

- Select 1Ø2W, 60Hz, 1000A and then click OK. The following screen will appear:

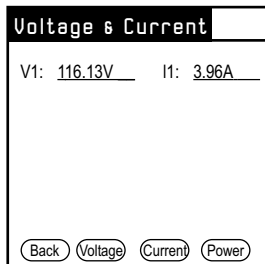

- Once you get into this screen, you can get real time readings for voltage and current and their associated waveforms and harmonics. You can also get readings for power.

How to Monitor Voltage Only?

Click on the **Voltage** button located at the bottom of the screen. The voltage reading for the monitoring phase will be displayed with its respective frequency.

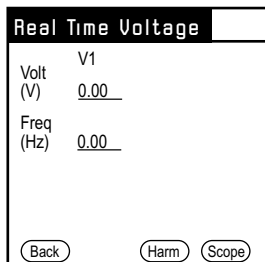

In order to display the voltage waveform or harmonics for the monitored phase, click on **Scope** or **Harm** buttons. The waveform or the harmonics table for the monitored voltage phase will be displayed.

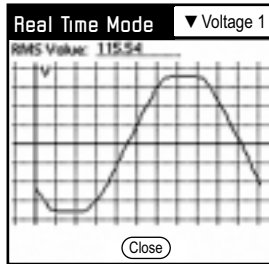
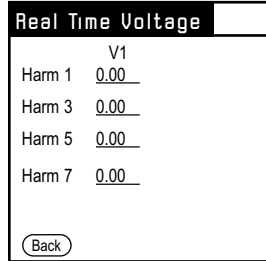



Real Time Voltage	
V1	
Harm 1	0.00
Harm 3	0.00
Harm 5	0.00
Harm 7	0.00

Back

How to Monitor Current Only?

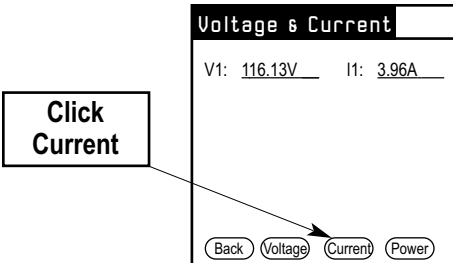
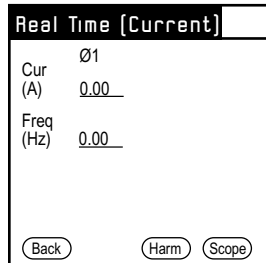
From the Voltage and Current screen, click on the **Current** button. You will be prompted to the current only real time display. The RMS value for the monitored phase will be reported with its respective frequency.

Real Time [Current]	
Ø1	
Cur (A)	0.00
Freq (Hz)	0.00

Back Harm Scope

In order to display the current waveform or the harmonics for the monitored phase, click on **Scope** or **Harm** buttons. The waveform graph or the harmonics table for the monitored Current phase will be displayed.



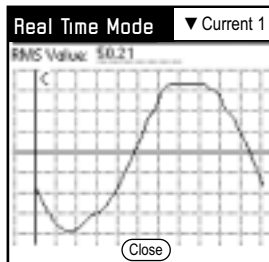
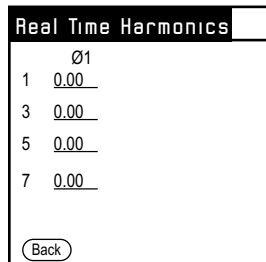

Real Time Harmonics	
Ø1	
1	0.00
3	0.00
5	0.00
7	0.00

Back

How to Monitor Power Only?

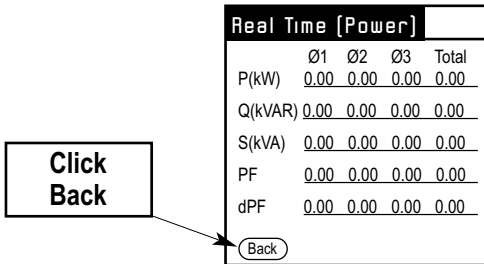
From the Voltage and Current screen menu, click on the **Power** button located at the bottom of the screen. The Real Time Power screen will appear as shown below with the following information: Real Power: P (kW); Reactive Power: Q (kVAR); Apparent Power: S (kVA); True Power Factor: pF; and the displacement power factor: dPF. To return to the previous screen, click on the Back button.



3- Phase 4-wire, 60Hz System Using 1000A Clamp

- Once you have the DM-4 connected with your electrical system, you can follow the same steps from paragraph 4.3 to paragraph 4.4.1.
- Select 3Ø4W, 60Hz, 1000A and then click OK.

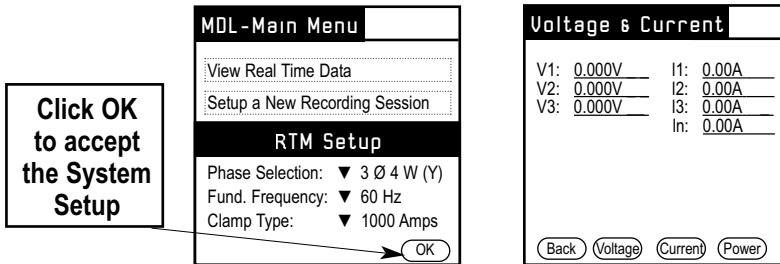

- The Voltage and Current screen should display the readings for all three phases as shown above.
- You can access the readings for voltage, current and power with their respective waveforms and harmonics tables as described on “How to monitor voltage only?”, “How to monitor current only?”, and “How to monitor power only?” in paragraph 4.4.1 for the 1Ø2W system.

3-Phase 3-wire, 60HZ system with 1000A Clamp

Because the 3Ø3W system doesn't have a neutral wire, you need to follow the proper direction given in this manual to connect the DM-4 with the 3Ø3W electrical system you want to monitor. Refer to paragraph 11.3

- Follow the same procedures as for 1Ø2W and 3Ø4W systems. The following screen should appear when accepting the system configuration setup for 3Ø3W.

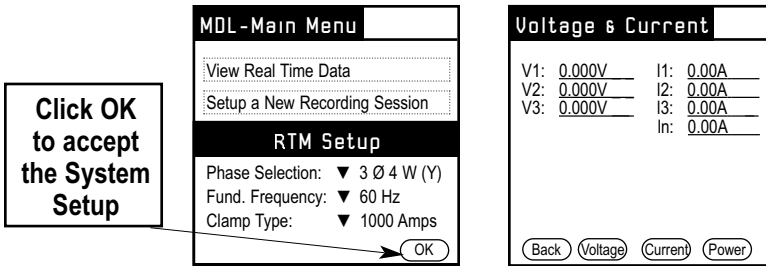

4.4.2 Setup A New Recording Session

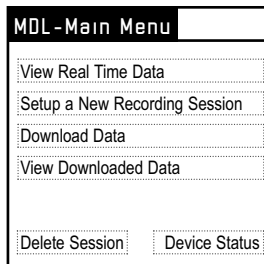

From the main menu, click on **“Setup A New Recording Session”**. The MDL system Setup menu will be displayed.

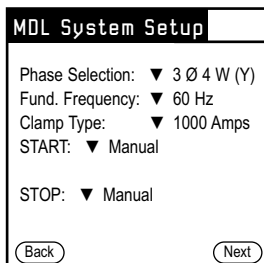

The MDL System setup allows you to configure the data logger device for the type of power system you want to perform the recording.

- **Phase Selection:** 1Ø2W; 1Ø3W; 3Ø3W (Delta configuration); 3Ø4W (Wye configuration).
- **Fund. Frequency:** 50-Hz; 60-Hz
- **Clamp Type:** 100 Amps; 1000 Amps; 3000 Amps
- **Integration Period:** 5s, 15s, 30s, 1min, 5min, 15min, 30min, 1 hr
- **Start:** Manual or Automatic
 - **Manual:** Recording session starts when you click on the “Record Now” button in later screen
 - **Automatic:** Recording session will start at the preset time.
- **Stop:** Manual or Automatic
 - **Manual:** Recording session stops when you click on “stop recording”
 - **Automatic:** Recording session stops at the preset time.

4.4.3 Set Date and Time For Automatic Recording Session

To set the date and time for an Automatic Recording session, follow the steps below as shown on the screens on the previous page:

- Click on the drop down box of “START” and select “Set Time”
- Click on the drop down box of “Set Time” and select “Choose date”
- Select a date between the actual date of the year and 2031. (**NOTE: You cannot choose a date in the past, for example 2001 is not a valid date).**
- Repeat Step.2 to choose the time and click OK after a selection is made.
- Once you click on the RECORD button, the preset recording is stored in memory. You can disconnect the Remote User Interface (PDA) at this point.

MDL System Setup

Phase Selection: ▼ 3 Ø 4 W (Y)
 Fund. Frequency: ▼ 60 Hz
 Clamp Type: ▼ 1000 Amps
 Integration Period: ▼ 5 sec
 START: ▼ Set Time
 ▼ Tue 3/15/05 3:08 pm
 STOP: ▼ Set Time
 ▼ Tue 3/15/05 3:08 pm

(Back) (Next)

MDL System Setup

Phase Selection: ▼ 3 Ø 4 W (Y)
 Fund. Frequency: ▼ 60 Hz
 Clamp Type: ▼ 1000 Amps
 Integration Period: ▼ 5 sec
 START: ▼ Set Time
 Now
 Choose Date
 Choose Time

(Back) (Next)

Recording Start Date

◀ 2005 ▶

Jan	Feb	Mar	Apr	May	Jun	
Jul	Aug	Sep	Oct	Nov	Dec	
S	M	T	W	T	F	S
		1	2	3	4	5
6	7	8	9	10	11	12
13	14	(15)	16	17	18	19
20	21	22	23	24	25	26
27	28	29	30	31		

(Cancel) (Today)

MDL System Setup	
Phase Selection:	▼ 3 Ø 4 W (Y)
Fund. Frequency:	▼ 60 Hz
Clamp Type:	▼ 1000 Amps
Integration Period:	▼ 5 sec
START:	▼ Set Time
STOP:	<div style="border: 1px solid black; padding: 2px;"> Now Choose Date Choose Time </div>
<input type="button" value="Back"/> <input type="button" value="Next"/>	

MDL System Setup	
Phase Selection:	▼ 3 Ø 4 W (Y)
Fund. Frequency:	▼ 60 Hz
Clamp Type:	▼ 1000 Amps
Integration Period:	▼ 5 sec
START:	▼ Set Time
Recording Start Time	
3 : 08	<input type="button" value="▲"/> <input type="button" value="AM PM"/> <input type="button" value="▼"/>
<input type="button" value="OK"/> <input type="button" value="Cancel"/>	

5. MAIN MENU

MDL - Main Menu	
View Real Time Data	
Setup a New Recording Session	
Download Data	
View Downloaded Data	
Delete Session	Device Status

5.1 INITIAL SETTINGS

Initial settings are the last settings the user configured the unit at the time of the last use. Each time you access the device with the Remote User Interface (PDA) , you will be asked if you would like to retrieve the device existing settings. Click **YES** to retrieve the existing settings and **NO** to reset the device with the Remote User Interface (PDA) settings.

MDL - Main Menu	
View Real Time Data	
Setup a New Recording Session	
Retrieve Settings?	
	Do you want to retrieve current settings from the device?
<input type="button" value="Yes"/> <input type="button" value="No"/>	

5.1.1 How to Set the Date and Time?

When connecting to the data logger, if the date and time of the device are different from the Remote User Interface (PDA), the program will ask you if you would like to synchronize the data logger with the Remote User Interface (PDA). Click on **YES** to set the date and time manually or automatically. Click on **NO** to continue to use the device. **Important!!! (If you do not set the device time correctly, the automatic recording will not take place.)**

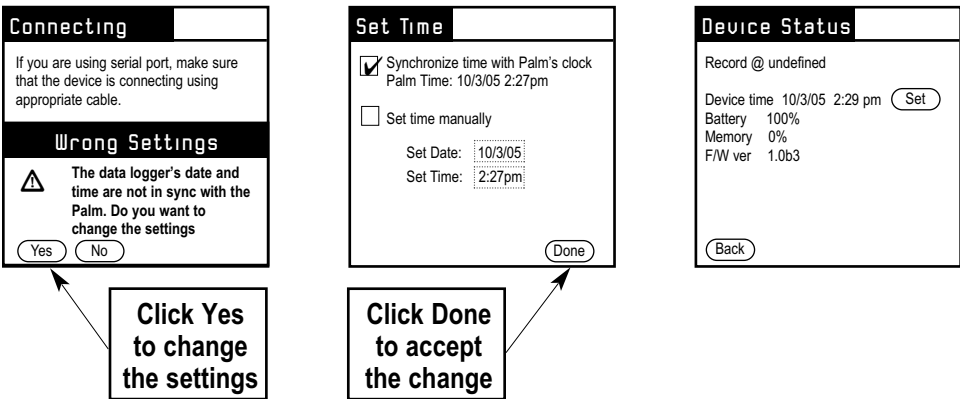

The image shows three sequential screenshots of the PDA interface:

- Connecting:** A message box with a black header "Connecting" and white text: "If you are using serial port, make sure that the device is connecting using appropriate cable." Below this is a black header "Wrong Settings" with a warning icon and text: "The data logger's date and time are not in sync with the Palm. Do you want to change the settings". At the bottom are "Yes" and "No" buttons.
- Set Time:** A screen with a black header "Set Time". It has a checked checkbox "Synchronize time with Palm's clock" with "Palm Time: 10/3/05 2:27pm" below it. There is an unchecked checkbox "Set time manually". Below these are input fields for "Set Date: 10/3/05" and "Set Time: 2:27pm". A "Done" button is at the bottom right.
- Device Status:** A screen with a black header "Device Status". It shows "Record @ undefined", "Device time 10/3/05 2:29 pm" with a "Set" button, "Battery 100%", "Memory 0%", and "F/W ver 1.0b3". A "Back" button is at the bottom left.

Two callout boxes with arrows point to the "Yes" button in the first screenshot and the "Done" button in the second screenshot:

- "Click Yes to change the settings" points to the "Yes" button.
- "Click Done to accept the change" points to the "Done" button.

NOTE. You can also use the Download Suite program to set the date and time in the device.

5.2 DEFAULT SETTINGS: ANALYZER CONFIG

The basic setting allows you to quickly set the device for a recording session with all the 456 parameters selected.

5.2.1 How to Set the Type of Electrical System Under Test

• Phase Selection

This parameter permits you to select the type of electrical system under test among the following configurations:

- 1Ø2W:** Single phase system
- 1Ø3W:** Single phase system
- 3Ø3W:** 3 wires system (three-phase system without neutral)
- 3Ø4W:** 4 wires system (three-phase system with neutral)

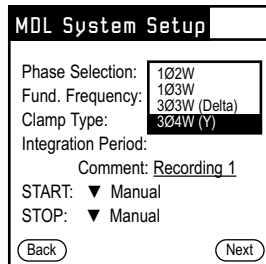

MDL System Setup

Phase Selection: 1Ø2W
Fund. Frequency: 1Ø3W
Clamp Type: 3Ø3W (Delta)
Integration Period: 3Ø4W (Y)
Comment: Recording 1
START: ▼ Manual
STOP: ▼ Manual

Back Next

• Clamp Type

The value of this parameter **must always be equal to the clamp type you are using**. Three types of clamps are available:

1000A: For Standard clamps of 1000 Amps

3000A: For Flexible clamps of 3000 Amps.

100A: For miniature clamps of 100 Amps.

Set the desired value by selecting the clamp type using the drop-down box.

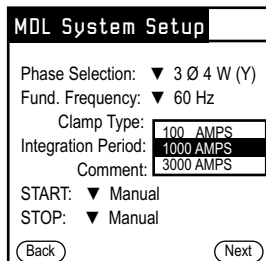

MDL System Setup

Phase Selection: ▼ 3 Ø 4 W (Y)
Fund. Frequency: ▼ 60 Hz
Clamp Type: 100 AMPS
Integration Period: 1000 AMPS
Comment: 3000 AMPS
START: ▼ Manual
STOP: ▼ Manual

Back Next

5.3 BASIC SETTING: RECORDER CONFIG

This option allows you to check and eventually modify the recording parameters and the selected parameters (up to a maximum of 456).

5.3.1 MDL Parameter Setup

This option allows you to setup the parameters for a recording session. When using the Remote User Interface (PDA) in basic setting, selecting any block will enable all the parameters under this block.

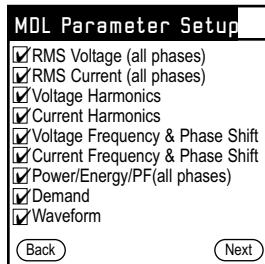

The screenshot shows a screen titled "MDL Parameter Setup" with a list of seven checked options: "RMS Voltage (all phases)", "RMS Current (all phases)", "Voltage Harmonics", "Current Harmonics", "Voltage Frequency & Phase Shift", "Current Frequency & Phase Shift", "Power/Energy/PF(all phases)", "Demand", and "Waveform". At the bottom, there are "Back" and "Next" buttons.

To select/deselect a function block, just click on the checked box. The check mark (✓) indicates that the function block has been selected.

5.3.2 MDL Voltage Anomalies

This option allows you to setup the parameters for all the anomalies (Sag, Surge, and Spike).

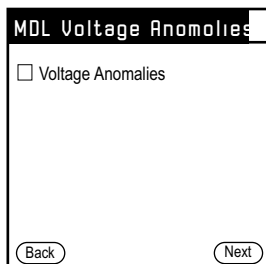

The screenshot shows a screen titled "MDL Voltage Anomalies" with a single unchecked option: "Voltage Anomalies". At the bottom, there are "Back" and "Next" buttons.

To select the voltage anomalies function block, just click on the checked box. A check mark (✓) indicates that the function block is enabled.

5.4 Advanced Setting: Recorder Configuration

The advanced setting option allows you to setup the desired parameters you want for a recording session.

To enter the advanced setting mode:

- 1) From the MDL main menu screen, click on **MDL Main Menu** and select **Options**

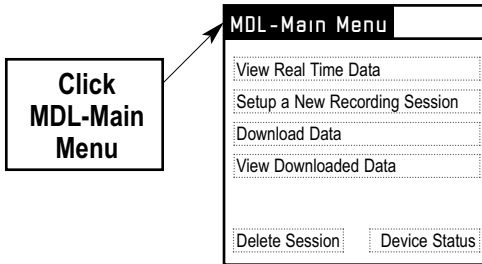

- 2) From **Options** down drop list, choose **MDL Preferences**

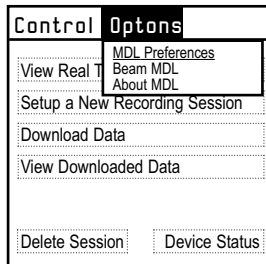

- 3) From **MDL Preferences** menu, select **Advanced Mode** by clicking on the checked box. A check mark (✓) indicates a selection. Press Ok to complete the selection. You should return to the main menu.

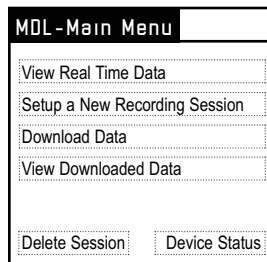
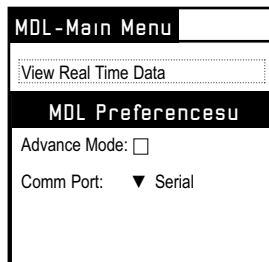

5.4.1 Setting the Parameters Individually

To set-up the parameters individually for a recording session, select “**Setup a New recording Session**” from the **MDL Main Menu**. The MDL System Setup will appear. Click on **Next** to enter the MDL Parameter Setup screen.

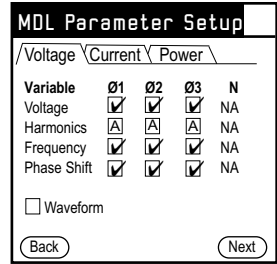
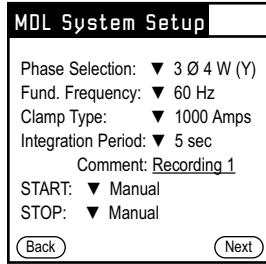
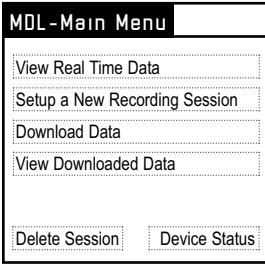

5.4.2 Advanced MDL Parameter Setup

The advanced MDL parameter setup option allows you to select one or all the parameters for one or all the phases for Voltage, Current, and Power.

5.4.3 Set up the Parameters for Voltage

1Ø2W Single Phase

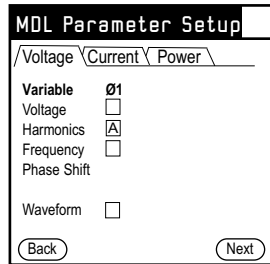

1Ø3W Single Phase

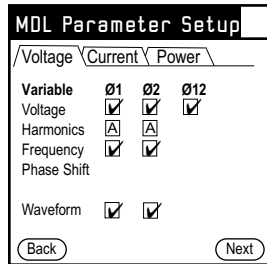

3Ø3W Delta Configuration 3-phase

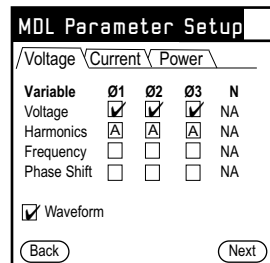

3Ø4W Wye Configuration 3-phase

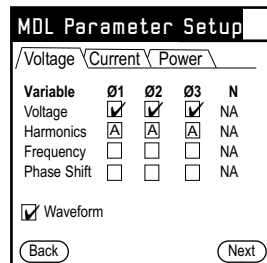

5.4.4 Setup the Parameters for Current

1Ø2W Single Phase

MDL Parameter Setup	
/Voltage / Current \ Power \	
Variable	Ø1
Current	<input type="checkbox"/>
Harmonics	[A]
Frequency	<input type="checkbox"/>
Phase Shift	
Waveform <input type="checkbox"/>	
<input type="button" value="Back"/> <input type="button" value="Next"/>	

1Ø3W Single Phase

MDL Parameter Setup	
/Voltage / Current \ Power \	
Variable	Ø1 Ø2
Current	<input checked="" type="checkbox"/> <input checked="" type="checkbox"/>
Harmonics	[A] [A]
Frequency	<input checked="" type="checkbox"/> <input checked="" type="checkbox"/>
Phase Shift	
Waveform <input checked="" type="checkbox"/> <input checked="" type="checkbox"/>	
<input type="button" value="Back"/> <input type="button" value="Next"/>	

3Ø3W Delta Configuration 3-phase

MDL Parameter Setup	
/Voltage / Current \ Power \	
Variable	Ø1 Ø2 Ø3 N
Voltage	<input checked="" type="checkbox"/> <input checked="" type="checkbox"/> <input checked="" type="checkbox"/> <input checked="" type="checkbox"/>
Harmonics	[A] [A] [A] [A]
Frequency	<input checked="" type="checkbox"/> <input checked="" type="checkbox"/> <input checked="" type="checkbox"/> NA
Phase Shift	<input checked="" type="checkbox"/> <input checked="" type="checkbox"/> <input checked="" type="checkbox"/> NA
<input checked="" type="checkbox"/> Waveform	
<input type="button" value="Back"/> <input type="button" value="Next"/>	

3Ø4W Wye Configuration 3-phase

MDL Parameter Setup	
/Voltage / Current \ Power \	
Variable	Ø1 Ø2 Ø3 N
Voltage	<input checked="" type="checkbox"/> <input checked="" type="checkbox"/> <input checked="" type="checkbox"/> <input checked="" type="checkbox"/>
Harmonics	[A] [A] [A] [A]
Frequency	<input checked="" type="checkbox"/> <input checked="" type="checkbox"/> <input checked="" type="checkbox"/> NA
Phase Shift	<input checked="" type="checkbox"/> <input checked="" type="checkbox"/> <input checked="" type="checkbox"/> NA
<input checked="" type="checkbox"/> Waveform	
<input type="button" value="Back"/> <input type="button" value="Next"/>	

5.4.5 Setup the Parameters for Power

1Ø2W Single Phase

MDL Parameter Setup	
/Voltage / Current / Power \	
Variable	Ø1 Ø2 Ø3 TOT
P (KWh)	<input checked="" type="checkbox"/> <input type="checkbox"/> <input type="checkbox"/> <input checked="" type="checkbox"/>
Q (kVARh)	<input checked="" type="checkbox"/> <input type="checkbox"/> <input type="checkbox"/> <input checked="" type="checkbox"/>
S(kVAh)	<input checked="" type="checkbox"/> <input type="checkbox"/> <input type="checkbox"/> <input checked="" type="checkbox"/>
PF	<input checked="" type="checkbox"/> <input type="checkbox"/> <input type="checkbox"/> <input checked="" type="checkbox"/>
dPF	<input checked="" type="checkbox"/> <input type="checkbox"/> <input type="checkbox"/> <input checked="" type="checkbox"/>
PF true/displ	<input checked="" type="checkbox"/> <input type="checkbox"/> <input type="checkbox"/> <input checked="" type="checkbox"/>
<input type="button" value="Back"/> <input type="button" value="Next"/>	

1Ø3W Single Phase

MDL Parameter Setup	
/Voltage / Current / Power \	
Variable	Ø1 Ø2 Ø3 TOT
P (KWh)	<input checked="" type="checkbox"/> <input checked="" type="checkbox"/> <input type="checkbox"/> <input checked="" type="checkbox"/>
Q (kVARh)	<input checked="" type="checkbox"/> <input checked="" type="checkbox"/> <input type="checkbox"/> <input checked="" type="checkbox"/>
S(kVAh)	<input checked="" type="checkbox"/> <input checked="" type="checkbox"/> <input type="checkbox"/> <input checked="" type="checkbox"/>
PF	<input checked="" type="checkbox"/> <input checked="" type="checkbox"/> <input type="checkbox"/> <input checked="" type="checkbox"/>
dPF	<input checked="" type="checkbox"/> <input checked="" type="checkbox"/> <input type="checkbox"/> <input checked="" type="checkbox"/>
PF true/displ	<input checked="" type="checkbox"/> <input checked="" type="checkbox"/> <input type="checkbox"/> <input checked="" type="checkbox"/>
<input type="button" value="Back"/> <input type="button" value="Next"/>	

3Ø3W Delta Configuration 3-phase
3Ø4W Wye Configuration 3-phase

MDL Parameter Setup				
	/Voltage / Current / Power			
Variable	Ø1	Ø2	Ø3	TOT
P (KWh)	<input checked="" type="checkbox"/>	<input checked="" type="checkbox"/>	<input checked="" type="checkbox"/>	<input checked="" type="checkbox"/>
Q (kVARh)	<input checked="" type="checkbox"/>	<input checked="" type="checkbox"/>	<input checked="" type="checkbox"/>	<input checked="" type="checkbox"/>
S(kVAh)	<input checked="" type="checkbox"/>	<input checked="" type="checkbox"/>	<input checked="" type="checkbox"/>	<input checked="" type="checkbox"/>
PF	<input checked="" type="checkbox"/>	<input checked="" type="checkbox"/>	<input checked="" type="checkbox"/>	<input checked="" type="checkbox"/>
dPF	<input checked="" type="checkbox"/>	<input checked="" type="checkbox"/>	<input checked="" type="checkbox"/>	<input checked="" type="checkbox"/>
PF true/displ	<input checked="" type="checkbox"/>	<input checked="" type="checkbox"/>	<input checked="" type="checkbox"/>	<input checked="" type="checkbox"/>

Back Next

MDL Parameter Setup				
	/Voltage / Current / Power			
Variable	Ø1	Ø2	Ø3	TOT
P (KWh)	<input checked="" type="checkbox"/>	<input checked="" type="checkbox"/>	<input checked="" type="checkbox"/>	<input checked="" type="checkbox"/>
Q (kVARh)	<input checked="" type="checkbox"/>	<input checked="" type="checkbox"/>	<input checked="" type="checkbox"/>	<input checked="" type="checkbox"/>
S(kVAh)	<input checked="" type="checkbox"/>	<input checked="" type="checkbox"/>	<input checked="" type="checkbox"/>	<input checked="" type="checkbox"/>
PF	<input checked="" type="checkbox"/>	<input checked="" type="checkbox"/>	<input checked="" type="checkbox"/>	<input checked="" type="checkbox"/>
dPF	<input checked="" type="checkbox"/>	<input checked="" type="checkbox"/>	<input checked="" type="checkbox"/>	<input checked="" type="checkbox"/>
PF true/displ	<input checked="" type="checkbox"/>	<input checked="" type="checkbox"/>	<input checked="" type="checkbox"/>	<input checked="" type="checkbox"/>

Back Next

5.4.6 Setup the Parameters for Voltage Harmonics

To setup the parameters for voltage harmonics, you must be in the **advanced mode** when programming with the Remote User Interface (PDA).

- 1) From the main menu, select **start a new recording session**. The **MDL System Setup** screen appears. If you have already setup the device for the system you want to monitor, click on **NEXT** and the MDL parameter setup screen should appear. If you haven't done so, refer to section 5.2.1

MDL - Main Menu	
View Real Time Data	
Setup a New Recording Session	
Download Data	
View Downloaded Data	
Delete Session	Device Status

MDL System Setup	
Phase Selection: ▼ 3 Ø 4 W (Y)	
Fund. Frequency: ▼ 60 Hz	
Clamp Type: ▼ 1000 Amps	
Integration Period: ▼ 5 sec	
Comment: <u>Recording 1</u>	
START: ▼ Manual	
STOP: ▼ Manual	

Back Next

- 2) From the MDL parameter setup screen, select **voltage** and choose “A” (harmonic) under the phase you want to monitor. You need to setup each phase separately when monitoring more than one phase.

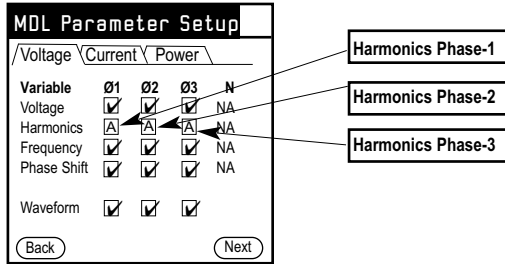

- 3) From the Harmonics setup screen, you can select the harmonics you want to enable by clicking on the numbers. To unselect a number, just click on it another time. Click on **done** to confirm the selections.

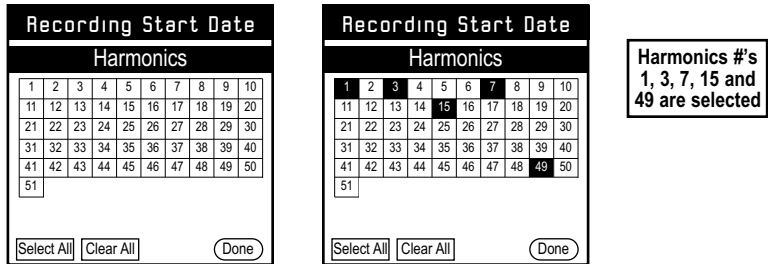

5.4.7 Setup the Parameters for Current Harmonics

To setup the parameters for current harmonics, repeat step 5.4.5 and select **Current** in step.2

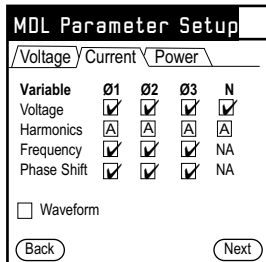

5.5 Download Data

After a recording session, you can retrieve your data by downloading the file from the device to your PC, using the Download Suite, or from the device to your Remote User Interface (PDA).

5.5.1 Download Data with the Remote User Interface (PDA)

To retrieve a file from the device with your Remote User Interface (PDA), click on Download Data from the MDL main menu. On the **Remote Recordings** screen, select the file you want to download and click on **Download**. Once Downloading recording is complete, you will be redirected back to the Remote Recordings screen. If you don't have any more recording files to download, click on the back button to return to the main menu.

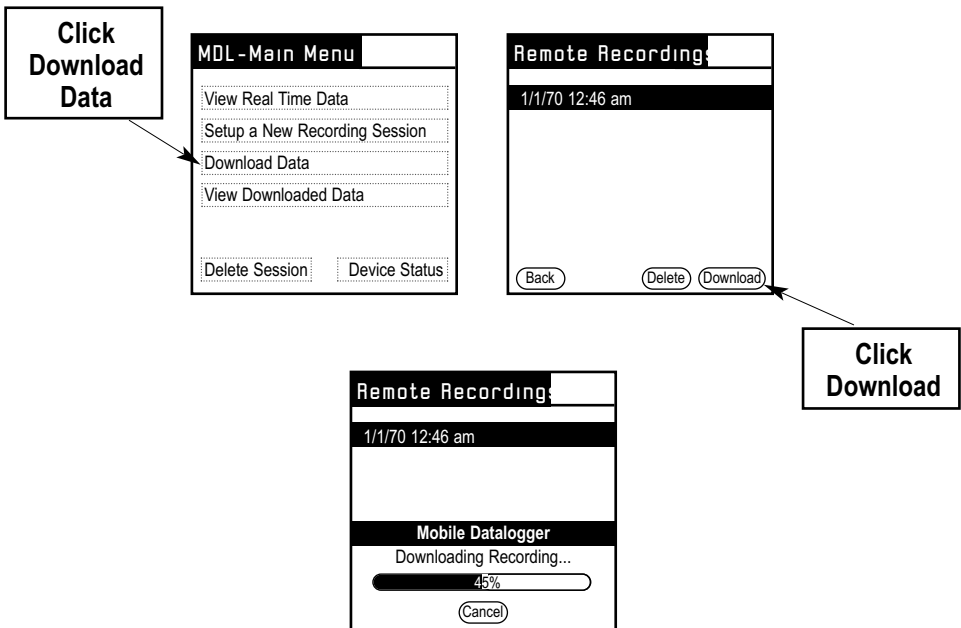

5.5.2 View Downloaded Data

This option allows you to view all downloaded files in the Remote User Interface (PDA). Once a file is downloaded, you can select it to be viewed. To view a downloaded file, click on **View Downloaded Data** from the **MDL main menu**. The program will prompt you to the **Saved Recordings** screen. Select the file you want to view by clicking on it once.

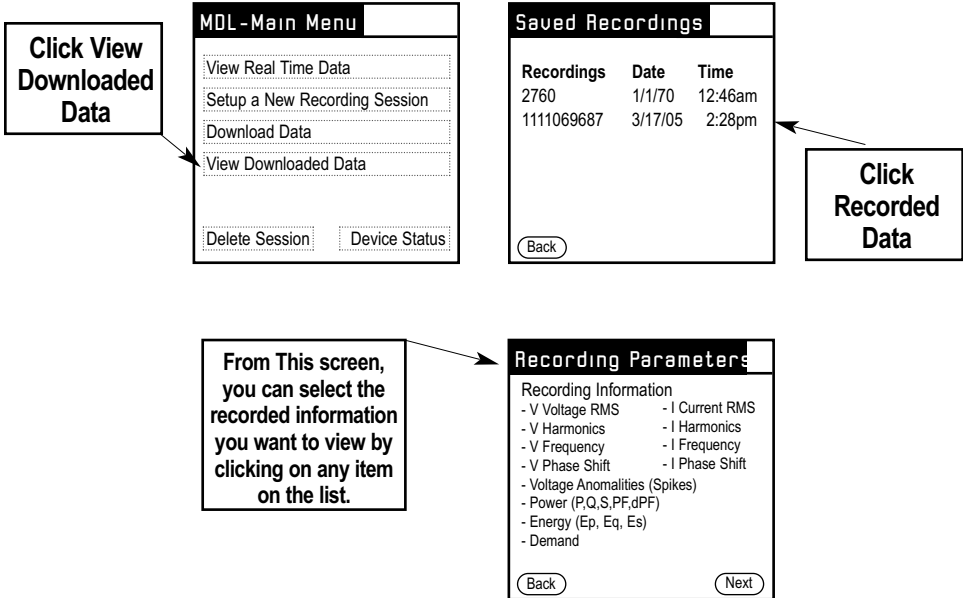

5.5.3 Recording Information

The recording information dialog box allows you to view the settings that have been used in this recording session. Click on **“OK”** to return to the **recording parameters** screen.

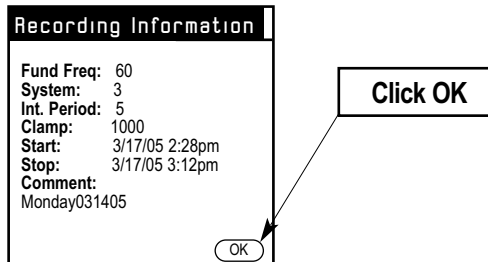

5.5.4 Delete Session



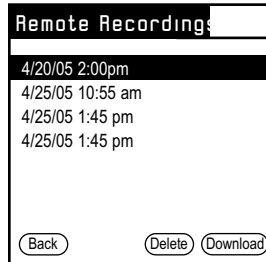
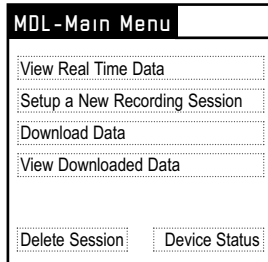



To delete a recording session from the device, choose Delete Session from the **main menu**. The device will prompt you to the remote recording files. From the remote recording files screen, select a file or the files you want to delete and then click on Delete.



Select the recording session you want to delete and click on **Delete**

Symbols	Description	Advised Settings
START:MAN	The recording of all the selected parameters will start at 00 seconds after pressing RECORD	☺
STOP:MAN	The recording of all the selected parameters will be interrupted manually by pressing RECORD .	☺
START:AUTO STOP:AUTO	The recording of all the selected values will be started / interrupted at the set dates and times. In order to start the recording the user will have to select RECORD to set the instrument in Stand-by mode until the start date and time previously set.	
INT. PERIOD	The value of this parameter determines how many seconds the values of all the selected parameters will be stored. Available choices: 5sec, 15sec, 30sec, 1min, 5min, 15min, 30min, 1hr.	15min ☺
HARM REC.	<p>Enable = the instrument will record the values of the selected voltage and current harmonics corresponding to the voltages and currents selected in the corresponding pages "Voltage" and "Current".</p> <p>Example: If the following Parameters are selected:</p> <p>a) Phase Voltage 1 and 2, Thd, Harmonics 1, 3, 5. b) Phase Current 2 and 3, Thd, Harmonics 3, 5, 7.</p> <p>The instrument will record:</p> <p>a) The Phase Voltage 1 and 2, Thd and Harmonics 1,3,5 of the Phase Voltage 1 and 2 while it will not record anything about Phase Voltage 3 b) The Phase Current 2 and 3, Thd and Harmonics 3,5,7 of the Phase Current 2 and 3 while it will not record nothing about Phase Current 1</p>	☺
	Disable = the instrument will not record any voltage or current harmonic selected	

Symbols	Description	Advised Settings
ANOM REC.	Enable = the Instrument will record Voltage Sag, Surge, and voltage spike	☺
	Disable = the instrument will not record any voltage Sag, Surge, and voltage spike.	
V1, V2, V3 V12, V23 or V32, V31	RMS value of the voltage of phase 1, phase 2, phase 3 respectively, values of the phase-to-phase voltages 1-2, 2-3 or 3-2 and 3-1.	☺ Single phase: V1 3 wires V₁₂ V₃₂ V₃₁ 4 wires V₁, V₂, V₃
Thd, DC, 01...51	Voltage Total Harmonic Distortion, DC Component, 01..51 Harmonics respectively	☺ Thd,01,03,05,07
Vref (Only if ANOM. REC flag has been enable)	RMS reference value for Voltage used in Voltage Anomalies detection (Voltage Sag and Surge). The Reference is: a) Voltage Phase to Neutral for Single Phase and 4 wires three phase system b) Voltage Phase to Phase for 3 wires three phase system	☺ Single phase: 230V 3 wires: 400V 4 wires: 230V
LIM+, LIM- (Only if ANOM. REC flag has been set ON)	High and Low Voltage Percent threshold used in Voltage Anomalies detection (Voltage Sag and Surge). Example: Three Phase System 4 wires. Vref = 120, LIM+= 10%, LIM-=10% => High Lim = 132V, Low Lim = 108.0V The Instrument will detect a voltage Anomalies if the RMS Voltage Values (calculated every 14ms) beyond the above calculated thresholds	☺ Single phase: 120V 3 wires: 480V 4 wires 277V
I1, I2, I3, IN	RMS value of the current of phase 1, phase 2, phase 3 and of the neutral respectively.	☺ Single phase: I1 3 wires: I1, I2, I3 4 wires I1, I2, I3, IN
Thd, DC, 01..51	Current Total Harmonic Distortion, DC Component, 01..51 Harmonics respectively	Thd,01,03,05,07
Pt, P1, P2, P3, P12, P32, P31	Values of the active power (total, of phase 1, phase 2 and phase 3) (only for 3 wires measurement) value of the power measured by the Wattmeter 1-2 and 3-2 respectively.	☺ Single phase: P1 3 wires: Pt 4 wires Pt, P1, P2, P3

Symbols	Description	Advised Settings
Qt, Q1, Q2, Q3, Q12, Q32, Q31	Values of the inductive reactive power (total, of phase 1, phase 2, phase 3) (only for 3 wires measurement) value of the reactive inductive power measured by the VAR meters 1-2 and 3-2 respectively	 Single phase: Q1 3 wires: Qt 4 wires Qt, Q1, Q2, Q3
-Qt, -Q1, -Q2, -Q3, -Q12, -Q32, -Q31	Values of the capacitive reactive power (total, of phase 1, phase 2, phase 3) (only for 3 wires measurement) value of the reactive capacitive power measured by the VA meters 1-2 and 3-2 respectively	4 wires Qt, Q1, Q2, Q3
St, S1, S2, S3, S12, S32, S31	Values of the apparent power (total, of phase 1, phase 2, phase 3) (only for 3 wires measurement) value of the power measured by the VA meters 1-2 and 3-2 respectively	 Single phase: S1 3 wires: St 4 wires St, S1, S2, S3
Pft, Pf1, Pf2, Pf3	Values of the power factors (total, of phase 1, phase 2 and phase 3 respectively)	 Single phase: Pf1 dPft 3 wires: Pft dPft 4 wires Pft Pf1 Pf2 Pf3 dPft dPf1 dPf2 dPf3
dpft, dpf1, dpf2, dpf3	Values of the $\cos\Theta$ (total, of phase 1, phase 2 and phase 3 respectively)	4 wires Pft Pf1 Pf2 Pf3 dPft dPf1 dPf2 dPf3
Eat, Ea1, Ea2, Ea3	Values of the active energy (total, of phase 1, phase 2, phase 3)	 Single phase: Ea1 3 wires: Eat 4 wires Eat Ea1 Ea2 Ea3
Ert, Er1, Er2, Er3	Values of the inductive reactive energy (total, of phase 1, phase 2 and phase 3)	 Single phase: Er1 3 wires: Ert 4 wires Ert Er1 Er2 Er3
-Ert, -Er1, -Er2, -Er3	Values of the capacitive reactive energy (total, of phase 1, phase 2, phase 3)	4 wires Ert Er1 Er2 Er3
Est, Es1, Es2, Es3	Values of the Apparent Energy (total, of phase 1, phase 2, phase 3)	 Single phase: Es1 3 wires: Est 4 wires Est Es1 Es2 Es3

Selecting a power factor (Pf) or a $\cos\Theta$ (dPf) for the recording automatically their inductive value and their capacitive value will be recorded separately.

5.5.5 RESET (PRESS AND HOLD RESET KEY WHILE PRESSING ON RECORD)

This option re-establishes the default settings of the instrument.

The default settings of the instrument consist of:

ANALYZER CONFIG:

Frequency: 60Hz

Full scale of the clamps: 1000A

Type of electrical system: 4 wires

RECORDER CONFIG:

Start: Manual (the recording is started at 00 sec mark on clock after pressing the RECORD key)

Stop: Manual

Integration period: 5S

Recording of harmonics: ON

Recording of Sag and Surge: OFF

Voltage Reference for Sag and Surge detection: 480V

Upper Limit for Sag and Surge detection: 10%

Lower Limit for Sag and Surge detection: 10%

Selected voltages: V1, V2, V3

Selected voltage harmonics:

Selected currents: I1, I2, I3, IN

Selected current harmonics:

Powers, Pf and $\cos\theta$ selected:

Pt, P1, P2, P3

Qt, Q1, Q2, Q3

St, S1, S2, S3

Pft, Pf1, Pf2, Pf3

dpft, dpf1, dpf2, dpf3

Energies:

Eat, Ea1, Ea2, Ea3

Erit, Eri1, Eri2, Eri3

Erct, Erc1, Erc2, Erc3

Est, Es1, Es2, Es3

Note: The RESET command will not erase the instrument's memory.

6. RECORDING CONFIGURATION

More practically, we may schematize the right procedure of use as follows:

- 1) Connect the External Power Supply
- 2) Check and eventually modify the basic settings of the instrument.
- 3) Select the parameters to be recorded.
- 4) Connect the DM-4 to the electrical system to be tested and push the ON/OFF button
- 5) Evaluate the values of the parameters under test
- 6) If you want to record:
 - A) Decide what to record
 - B) Select MDL Setup Parameter and check if the existing parameters meet your requirements
- 7) Start the recording by pressing RECORD.

7. STARTING A RECORDING

You can start a recording manually or automatically. Therefore, after setting all the parameters **and click on RECORD**, the instrument will start recording:

MANUALLY: The recording will start when Instrument's time reaches the "00" seconds value after pressing RECORD.

AUTOMATICALLY: If the operator has clicked on **RECORD** the instrument will remain in stand-by until the date and time previously set, then the recording will start. **If the operator has not clicked on RECORD, the recording will never start.**



CAUTION

For recordings **ALWAYS use the external power supply** even though the instrument allows the operator to perform a recording using internal batteries.

If during a recording the external power supply is de-energized, the instrument will continue the recording using the internal battery power until the batteries are exhausted (the data stored until the definitive turning off won't get lost). For this reason we recommend that you **ALWAYS insert a new set of batteries before a long recording.**

- If the instrument is recording or is measuring energy (and the external power supply is not connected), the recording will continue until the batteries are exhausted.

Before starting a recording the operator should first evaluate the state of the equipment, decide what to record and set the instrument accordingly.

In order to facilitate this task the instrument has been factory pre-set with a general configuration which should fit most cases. Using the RESET option (See paragraph 5.6).

By pressing **RECORD** the recording of the selected parameters is started according to the settings made in the MENU (see paragraphs 5.2 and 5.3).

As the default value of the integration periods is set at 5 seconds the instrument will store data in the temporary memory every 5 seconds. Afterwards the instrument will explain the results saved in the temporary memory and will save the first series of values in the permanent memory. Therefore, if an integration period of 5 seconds has been set, the recording will continue for about 5 seconds before producing a set of recorded values. If the recording is interrupted before the selected integration period has completely elapsed, the data stored in the temporary memory (SRAM) will not be elaborated and the corresponding series of values won't be transferred to the permanent memory (FLASH).

8. RECORDING IN PROCESS

If during a recording the external power supply is de-energized, the instrument will continue the recording using the internal battery power until the batteries are exhausted (the data stored up to the point the instrument shuts down won't get lost). For this we recommend you **ALWAYS insert a new set of batteries before a long recording**. You may not be able to download this file with the Remote User Interface (PDA) device. We recommend that you use the **Download Suite** to open this file.

During a recording the following commands are disabled:

- **AUTOPOWER OFF function**
- **ON/OFF key**
- **RESET key**

Click **"DEVICE STATUS"** on the main menu and the following screen will appear:

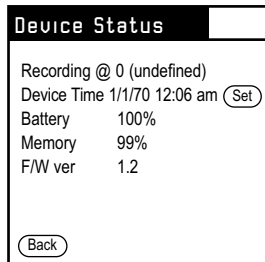

This page includes:

- 1) Recording information
- 2) Device Date and Time
- 3) Battery condition
- 4) Memory size available
- 5) Firmware version

9. STOPPING A RECORDING

The instrument uses a protective routine to avoid the risk of being disturbed or interrupted during a recording or an energy measurement. Once a recording has been started using automatic record mode, it won't be sufficient to press the RECORD key on the device to stop the recording. You need to use the Remote User Interface (PDA) or the download suite to stop the recording.

9.1 Stop a Recording with the REMOTE USER INTERFACE (PDA)

To stop a recording with the Remote User Interface (PDA), click on the MDL Main Menu screen and then select STOP RECORDING.

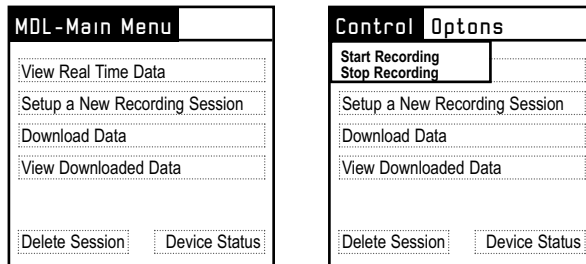

9.2 Stop a Recording with the Download Suite

To stop a recording with the download suite, go to control panel screen window and then click on stop recording.

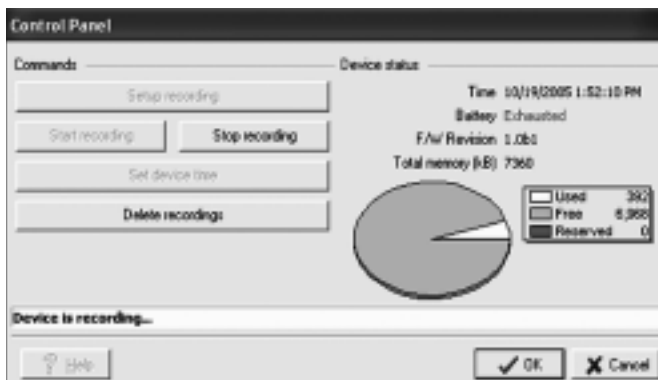

10. CONNECTING THE INSTRUMENT TO A PC

In order to connect the instrument to a PC you must connect the serial cable shipped with the instrument to the serial output of the PC.

The DM-IV serial cable has the following inner connections:

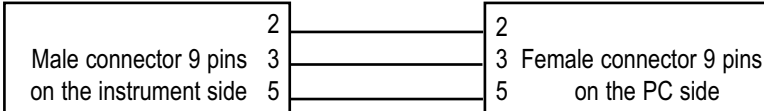

The available transmission speeds are the following:
4800, 9600, 19200, 57600(default value)

The value of the transmission speed (Baud Rate) must be selected on the Remote User Interface (PDA) or the Download Suite in order to have proper communication. The download suite will always look for COM1 first if the setting is set to **AUTOMATICALLY**.



For download suite instructions please refer to software help file.

In order to transfer the recorded data from the instrument to the PC the following procedure must be followed:

- 1) **Switch ON the instrument**
- 2) **Connect the serial output of the instrument to the serial output of the PC through the serial cable**

- 3) Install the software and start it – Close the introduction window
- 4) Press F2 and follow the commands.
- 5) Refer to software help file for further instructions.

11. MEASURING PROCEDURES

11.1 USING THE INSTRUMENT IN A SINGLE PHASE SYSTEM



CAUTION

The maximum voltage between L1 and COM inputs is CATIII 635V~ phase-phase and 370V~ phase – earth. Do not measure voltages exceeding the limits prescribed by this manual. Should you exceed the voltage limits you could damage the instrument and/or its components or endanger your safety.

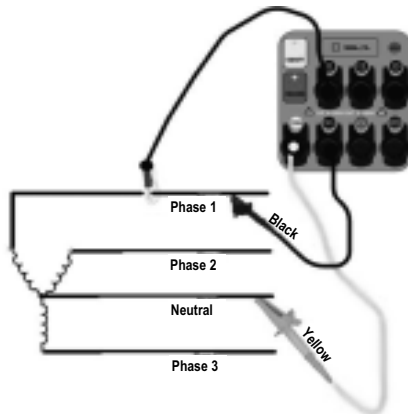

Instrument connection in a single-phase system



CAUTION

If possible, before connecting the instrument to the electrical system, remove the power off the electrical system.

- 1) Check the cables connection.
- 2) Connect the phase and neutral voltage wires according to the connections shown in the above picture.

- 3) Turn ON the unit by pressing the ON/OFF push button
- 4) If you want to measure current and power, connect the clamp meter to the phase conductor respecting the specifications shown on the clamp and the connections shown in the picture.
- 5) Apply voltage to the electrical equipment under test (if previously shut off for the instrument connection).
- 6) The values of the available electrical parameters will be displayed on the Remote User Interface (PDA) display or the PC screen. For further details see the Remote User Interface (PDA) settings.
- 7) If you want to record, simply press the RECORD push button on the device.

11.2 USING THE INSTRUMENT IN A THREE PHASE 4- WIRE SYSTEM (WYE)



CAUTION

The maximum voltage between L1, L2, L3 & COM inputs is CAT III 635 V~ phase – phase 370 V~ phase to earth. Do not measure voltages exceeding the limits prescribed by this manual. Should you exceed the voltage limits you could damage the instrument and/or its components or endanger your safety.

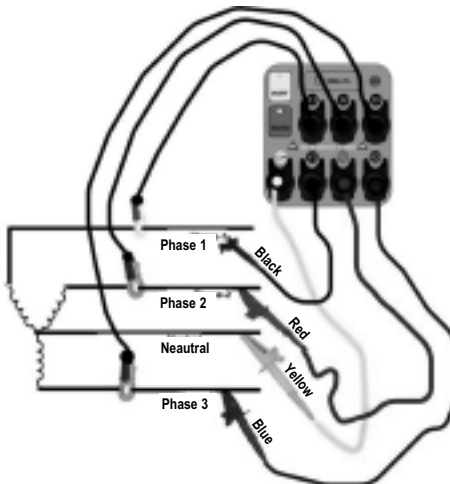

Instrument connection in a three-phase 4 wire system

**CAUTION**

If possible, before connecting the instrument to the electrical equipment to be tested take the power supply off the electrical equipment.

- 1) Check the cables connection.
- 2) Connect the phase and neutral voltage wires respecting the connections shown in the picture.
- 3) If you want to measure current and power, connect the clamp meter to the phase conductor respecting the specifications shown on the clamp and the connections shown in the picture. In case of doubts select the position **POWER** and, connecting one clamp at a time, check if:
 - a) The phase sequence is correct
 - b) The active power P of each phase is positive.
 - c) The value of the Pf of each phase is not excessively low (typically it's not lower than 0.4). In case the Pf is lower than 0.4, check if the phase voltage is associated to the right clamp meter (for example the voltage of phase 1 must be associated to the clamp meter no. 1).
- 4) Apply voltage to the electrical equipment under test (if previously shut off for the instrument connection).
- 5) The values of the available electrical parameters will be displayed.
- 6) If you want to record:
 - a) Check and, if needed, modify the values of the basic parameters (see paragraphs 5.2 and 5.3).
 - b) Check and, if needed, modify the recording parameters.
 - c) To start the recording press **RECORD**.

11.3 USING THE INSTRUMENT IN A THREE PHASE 3- WIRE SYSTEM (DELTA)



CAUTION

The maximum voltage between V1, V2, V3 and COM (L2) inputs is CATIII 600V~ phase-phase. Do not measure voltages exceeding the limits prescribed by this manual. Should you exceed the voltage limits you could damage the instrument and/or its components or endanger your safety.

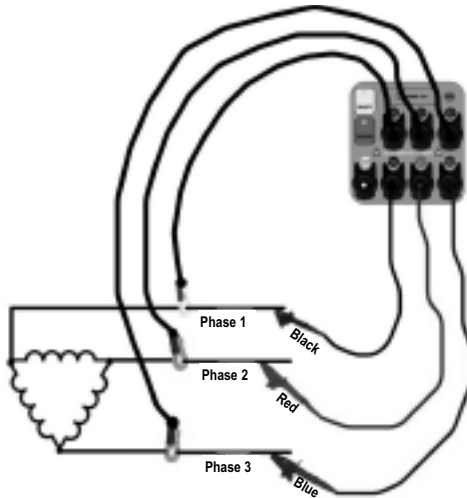

Instrument connection in a 3 wires three-phase system (DELTA)



CAUTION

Please note that in this case the yellow cable (neutral) is connected with the red cable on phase 2. You can use any phase you want as reference.



CAUTION

If possible, before connecting the instrument to the electrical equipment to be tested take the power supply off the electrical equipment.

- 1) Check, and if needed modify, the basic settings of the instrument (see paragraphs 5.2 and 5.3). Particularly, the **3 wires** mode must be set.
- 2) Connect the phase and neutral voltage wires respecting the connections shown in the picture.
- 3) If you want to measure current and power, connect the clamp meter to the phase conductor respecting the specifications shown on the clamp and the connections shown in the picture. Check if:
 - a) The phase sequence is correct
 - b) The active power P of each phase is positive.
 - c) The value of the Pf of each phase is not excessively low (typically it's not lower than 0.4). In case the Pf is lower than 0.4, check if the phase voltage is associated to the right clamp meter (for example the voltage of phase 1 must be associated to the clamp meter no. 1).
 - d) After checking, and if needed modifying, the connection of the instrument to the equipment re-set the **3 wires** mode and the connections shown in the picture (yellow and red wire together).
- 4) Apply voltage to the electrical equipment under test (if previously shut off for the instrument connection).
- 5) The values of the available electrical parameters will be displayed of the instrument.
- 6) If you want to record:
 - a) Check and eventually modify the values of the basic parameters (see paragraphs 5.2-5.3).
 - b) Check and eventually modify the recording parameters (see How to set the parameters using Remote User Interface (PDA)).
 - c) To start the recording press **RECORD**

12. MAINTENANCE

12.1 GENERAL

The DM-4 is a precision instrument. For its' use and storage, follow the recommendations and instructions contained in this manual in order to avoid possible damages. Never use the instrument in environments with a high humidity or temperature. Always turn off the instrument if it is not in use.

12.2 BATTERY REPLACEMENT

When the battery indicator indicates less than 50% (), the batteries must be replaced.



CAUTION

Only qualified technicians should operate the instrument. Before replacing the batteries, disconnect the test leads from circuit under voltage in order to avoid electrical shocks.

- 1) Disconnect cables and clamps from the circuit under test.
- 2) Turn the instrument off by pressing ON/OFF push button.
- 3) Remove the cables from the input terminals.
- 4) Unscrew the screw of the battery cover and remove the cover.
- 5) Replace the batteries with 8 new 1.5 V - AA. (*Alkaline LR6 is strongly recommended.*)
- 6) Reposition the cover and fasten it with the proper screw.

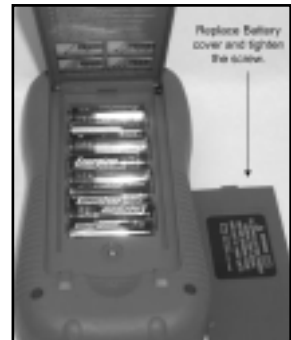
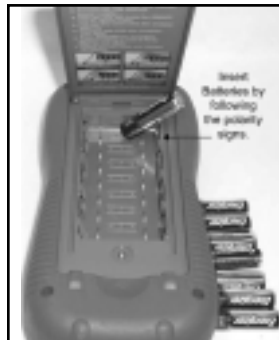

12.3 CLEANING

Use a soft dry cloth to clean the instrument. Do not use wet clothes, solvents, water and so on.

13. TECHNICAL SPECIFICATIONS

13.1 FEATURES

The accuracy is stated as [1% of the reading \pm number of 2 digits]. It refers to the following atmospheric conditions: temperature $73^{\circ}\text{F} \pm 2^{\circ}\text{F}$ ($23^{\circ}\text{C} \pm 1^{\circ}\text{C}$) with relative humidity $< 75\%$.

13.1.1 Voltage Measurement			
Range	Accuracy	Resolution	Input Impedance
20-370V	$\pm(3\%+2\text{digit})$	0.1V	300k Ω (phase-neutral)
310-635V		0.1V	600k Ω (phase-phase)

13.1.2 Voltage Anomalies Detection (Manual Selection of Range) Voltage			
Range	Accuracy	Resolution	Input Impedance
20-370V	$\pm(3\%+2\text{digit})$	0.1V	300k Ω (phase-neutral)
310-635V		0.1V	600k Ω (phase-phase)

Time	
Accuracy (ref. to 60Hz)	Resolution
$\pm 8.33\text{ms}$ (1/2 period of fundamental)	8.33ms (1/2 period of fundamental)

13.1.3 Current Measurement (Using external transducer)				
Range	Accuracy	Resolution	Input Impedance	Protection against overloads
0.005-0.26V	$\pm(2\%+2\text{digit})$		100k Ω	5V
0.26-1V				
<i>Minimal Current measurable is equal to 0.5% of Clamp Full Scale</i>				

13.1.4 Power Measurement (cosΘ: 0.5c – 0.5i)			
Value	Ranges	Accuracy	Resolution
Active Power	0 – 999.9W 1KW – 999.9KW 1MW – 999.9MW	$\pm(3\%+2\text{digit})$	
Reactive Power	0 – 999.9VAR 1KVAR – 999.9KVAR 1MVAR – 999.9MVAR		
Apparent Power	0 – 999.9VA 1KVA – 999.9KVA 1MVA – 999.9MVA		
Active Energy	0 – 999.9Wh 1KWh – 999.9KWh 1MWh – 999.9MWh		
Reactive Energy	0 – 999.9VARh 1KVARh – 999.9KVARh 1MVARh – 999.9MVARh		

13.1.5 CosΘ Measurement		
CosΘ	Resolution	Accuracy (expressed in degrees)
0.20	0.01	3°
0.50		4°
0.80		5°

13.1.6 Measurement of Harmonics

Voltage		
Range	Accuracy	Resolution
DC – 25h	$\pm(5.0\%+2\text{digit})$	0.1V
26h – 33h	$\pm(10.0\%+2\text{digit})$	
34h – 51h	$\pm(15.0\%+2\text{digit})$	
<i>The voltage harmonics will be null under the following threshold:</i> <ul style="list-style-type: none"> - DC: if <1V or <2% of 1st harmonic - 1st harmonic: if <2V - 2nd - 51st: if <1V or <2% 1st harmonic 		

Current		
Range	Accuracy	Resolution
DC – 25h	$\pm(5.0\%+2\text{digit})$	0.1A
26h – 33h	$\pm(10.0\%+2\text{digit})$	
34h – 51h	$\pm(15.0\%+2\text{digit})$	
<i>The voltage harmonics will be null under the following threshold:</i> <ul style="list-style-type: none"> - DC: if <2% of 1st harmonic or < 0,2% of clamp full scale - 1st harmonic: if < 0,2% of clamp full scale - 2nd - 51st: if <2% 1st harmonic or < 0,2% of clamp full scale Setting the FLEX option 3000A CT the DC component will be ignored.		

13.1.7 Temperature Drift

Temperature drift: 0.1 x accuracy/K

13.1.8 Safety

Insulation: Class 2

Pollution: 2

Over-voltage category: CAT III 600V~ (Phase-phase)
 CAT II 1000V~ (Phase-Phase)

13.1.9 General Characteristics

Mechanical Features

Dimensions: 8.9" (L) x 4.1" (La) x 2.1" (H)
225(L) x 104(La) x 54(H) mm

Weight: 3.3 Lb (1.5kg)

Internal Power Supply: 8 batteries 1.5V series AA

Battery Life: 3-hours

External Power Supply: Use only Amprobe power supply Adapter code DM4EXTPS

Display: LED

Sampling Speed: 83.33 usec at 60Hz.

No. of Samples Per Period: 128

Clamp

Opening: 2.15" (53 mm)

Maximum Diameter of The Cable: 2.00" (50 mm)

13.2 ENVIRONMENT

13.2.1 Operating conditions

Reference Temperature: 73°F ± 2°F (23°C ± 1°C)

Operating Temperature: 32°F to 122°F (0°C to 50 °C)

Relative Humidity: <70%

Storage Temperature: 14°F to 140°F (-10°C to 60 °C)

Storage Humidity: <80%

13.3 ACCESSORIES

13.3.1 Standard Accessories

The package contains:

Replacement Parts	Part Number
Remote user interface (PDA) with connection cable	<i>Recommended Tungsten E2 Ordered through PALM retailers, visit www.palm.com</i>
Instrument	DM-4
Carrying case	HW1254A
External power supply 12VDC	DM-4EXTPS
1000A Clamp	DM-CT-BKCE
Test Leads & Alligator Clips (Set of 4)	DVL-2
PDA/DM-4 Interface Cable	RS-PDA
RS-232 Computer Cable	C232NG1
Remote User Interface Protective Case	DM-4CASE
RS-232 To USB Converter Cable	RS-USB
1 User Manual	www.amprobe.com
Download Suite	www.amprobe.com
Palm OS software	www.amprobe.com

14. APPENDIX 1 – RECORDABLE PARAMETERS: SYMBOLS

Symbol	Description
V1, V2, V3	RMS value of the voltage of phase 1, phase 2, phase 3 respectively
V12, V23 V31	Value of phase to phase voltages
I1, I2, I3	RMS value of the current of phase 1, phase 2, phase 3 respectively
IN	RMS value of the current of the neutral
DC	Continuous component of voltage or current
h01 □ h51	Harmonic 01 □ Harmonic 51 of voltage or current
ThdV	Factor of total harmonic distortion of the voltage (see paragraph 14.2)
ThdI	Factor of total harmonic distortion of the current (see paragraph 14.2)
Pt, P1, P2, P3	Values of the total active power, of phase 1, phase 2, phase 3 respectively
P12, P32, P13	(only for 3 wires measurement) Value of the power measured by the Wattmeter. 1-2 and 3-2 respectively (see paragraph 14.3.2)
Qt, Q1, Q2, Q3	Values of the total reactive power, of phase 1, phase 2, phase 3 respectively
Q12, Q32, Q13	(only for 3 wires measurement) Value of the power measured by the VARmeter 1-2 and 3-2 respectively (see paragraph 14.3.2)
St, S1, S2, S3	Values of the total apparent power, of phase 1, phase 2, phase 3 respectively
S12, S32, S13	(only for 3 wires measurement) Value of the power measured by the VAmeter 1-2 and 3-2 respectively (see paragraph 14.3.2)
Pft, pf1, pf2, pf3	Value of the total power factors, power factors of phase 1, phase 2, phase 3 respectively
dPft, dpf1, dpf2, dpf3	Values of the total $\cos\Theta$, of phase 1, phase 2, phase 3 respectively
Eat, Ea1, Ea2, Ea3	Values of the total active energy, of phase 1, phase 2, phase 3 respectively
Ert, Er1, Er2, Er3	Values of the total inductive reactive Energy, of phase 1, phase 2, phase 3 respectively
-Ert, -Er1, -Er2, -Er3	Values of the total capacitive reactive Energy, of phase 1, phase 2, phase 3 respectively
Est, Es1, Es2, Es3	Values of the total Apparent Energy, of phase 1, phase 2, phase 3 respectively

Negative Q (reactive power) indicates capacitive phase shift. Negative P (real or active power) indicates generation not load and the CTs should be reversed, rotated 180°.

15. APPENDIX 2 – THEORETICAL OUTLINES

15.1 VOLTAGE ANOMALIES (VOLTAGE SAG AND SURGE; SPIKE)

The instrument records as voltage anomalies all those rms values, calculated every 11ms, beyond the percent thresholds of Voltage Reference (Vref) set during the programming. The maximum upper limit percent is reduced as Vref approaches 1000V.

THE REFERENCE MUST BE SET TO

Nominal Voltage Phase to Neutral: for Single Phase and 4 wires three phase system

Nominal Voltage Phase to Phase: for 3 wires three phase system

Example1: Three Phase System 3 wires

Vref = 400V, LIM+= 10%, LIM-=10% =>

High Lim = $480 \times (1+10/100) = 528V$

Low Lim = $480 \times (1-10/100) = 452V$

Example2: Three Phase System 4 wires

Vref = 277V, LIM+= 5%, LIM-=5% =>

High Lim = $277 \times (1+5/100) = 290.85V$

Low Lim = $277 \times (1-5/100) = 263.15V$

The Instrument will detect Voltage Anomalies if the RMS Voltage Values (calculated every 11ms) beyond the above calculated thresholds. These limits remain unchanged throughout the recording period.

When a Voltage Anomaly Occurs the Instrument Records:

- The number corresponding to the phase where the anomaly occurred.
- The “direction” of the anomaly: “UP” and “DN” identify respectively voltage drops (sag) and peaks (Surge).
- The date and time of the beginning of the event in the form day, month, year, hour, minutes, seconds, hundredths of second.
- The duration of the event, in seconds with a resolution of 11ms.
- The minimum (or maximum) value of voltage during the event.

15.2 VOLTAGE AND CURRENT HARMONICS

15.2.1 THEORY

Any periodical non-sine wave can be represented as a sum of sinusoidal waves having each a frequency that corresponds to an entire multiple of the fundamental, according to the relation:

$$v(t) = V_0 + \sum_{k=1}^{\infty} \hat{V}_k \sin(\omega_k t + \phi_k) \quad (1)$$

Where:

V_0 = Average value of $v(t)$

V_1 = Amplitude of the fundamental of $v(t)$

V_k = Amplitude of the k^{th} harmonic of $v(t)$

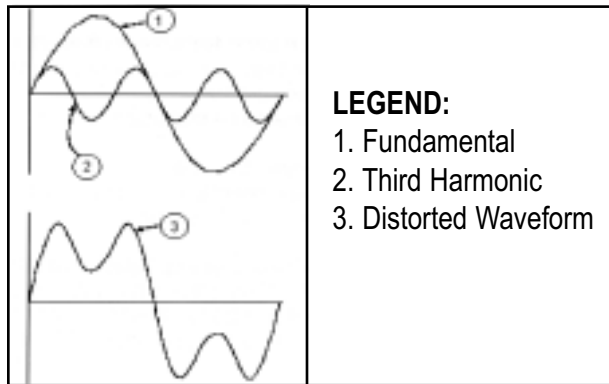

Effect of the sum of 2 multiple frequencies.

In the main voltage, the fundamental has a frequency of 60 Hz, the second harmonic has a frequency of 120 Hz, the third harmonic has a frequency of 180 Hz and so on. Harmonic distortion is a constant problem and should not be confused with short events such as sags, surges or fluctuations. It can be noted that in (1) the index of the sigma is from 1 to the infinite. What happens in reality is that a signal does not have an unlimited number of harmonics: a number always exists after which the harmonics value is negligible. The EN 50160 standard recommends to stop the index in the expression (1) in correspondence of the 40th harmonic.

A fundamental element to detect the presence of harmonics is T_{hd} defined as:

$$THD_V = \frac{\sqrt{\sum_{h=2}^{40} V_h^2}}{V_1}$$

This index takes all the harmonics into account. The higher it is, the more distorted the waveform gets.

15.2.2 Limit Values for Harmonics

EN-50160 fixes the limits for the harmonic voltages, which can be introduced into the network by the power supplier. In normal conditions, during whatever period of a week, 95% if the RMS value of each harmonic voltage, mediated on 10 minutes, will have to be less than or equal to the values stated in the following table. The total harmonic distortion (T_{hd}) of the supply voltage (including all the harmonics up to 40th order) must be less than or equal to 8%.

Odd Harmonics				Even Harmonics	
Not multiple of 3		Multiple of 3		Order h	Relative voltage % Max
Order h	Relative voltage % Max	Order h	Relative voltage % Max		
5	6	3	5	2	2
7	5	9	1,5	4	1
11	3,5	15	0,5	6.24	0,5
13	3	21	0,5		
17	2				
19	1,5				
23	1,5				
25	1,5				

These limits, theoretically applicable only for the supplier of electric energy, provide however a series of reference values within which the harmonics introduced into the network by the users must be contained.

15.2.3 Presence of Harmonics: Causes

Any apparatus that alters the sine wave or uses only a part of such a wave causes distortions to the sine wave and therefore harmonics. All current signals are in some way distorted. The most common situation is the harmonic distortion caused by non-linear loads such as household appliances, personal computers or speed control units for motors. Harmonic distortion causes significant currents at frequencies that are odd multiples of the fundamental frequency. Harmonic currents affect considerably the neutral wire of electric installations. In most countries, the main power is three-phase 50/60Hz with delta primary and star secondary transformers. The secondary generally provides 230V AC from phase to neutral and 400V AC from phase to phase. Balancing the loads on each phase has always represented a headache for electric systems designers. Until some ten years ago, in a well-balanced system, the vectorial sum of the currents in the neutral was zero or quite low (given the difficulty of obtaining a perfect balance). The devices were incandescent lights, small motors and other devices that presented linear loads. The result was an essentially sinusoidal current in each phase and a low current on the neutral at a frequency of 50/60Hz. "Modern" devices such as TV sets, fluorescent lights, video machines and microwave ovens normally draw current for only a fraction of each cycle thus causing non-linear loads and subsequent non-linear currents. All this generates odd harmonics of the 50/60Hz line frequency. For this reason, the current in the transformers of the distribution boxes contains only a 50Hz (or 60Hz) component but also a 150Hz (or 180Hz) component, a 300Hz (or 360Hz) component and other significant components of harmonic up to 750Hz (or 900Hz) and higher. The vectorial sum of the currents in a well-balanced system that feeds non-linear loads may still be quite low. However, the sum does not eliminate all current harmonics. The odd multiples of the third harmonic (called "TRIPLENS") are added together in the neutral and can cause overheating even with balanced loads.

15.2.4 Presence of Harmonics: Consequences

In general, even harmonics, i.e. the 2nd, 4th etc., do not cause problems. Triple harmonics, odd multiples of three, are added on the neutral (instead of canceling each other) thus creating a condition of overheating of the wire which is extremely

dangerous. Designers should take into consideration the three issues given below when designing a power distribution system that will contain harmonic current:

- The neutral wire must be of sufficient gauge.
- The distribution transformer must have an additional cooling system to continue operating at its rated capacity when not suited to the harmonics. This is necessary because the harmonic current in the neutral wire of the secondary circuit circulates in the delta-connected primary circuit. The circulating harmonic current heats up the transformer.
- Phase harmonic currents are reflected on the primary circuit and continue back to the power source. This can cause distortion of the voltage wave so that any power factor correction capacitors on the line can be easily overloaded.

The 5th and the 11th harmonics contrast the current flow through the motors making its' operation harder and shortens their average life.

In general, the higher the ordinal harmonic number, the smaller its energy is and therefore the impact it will have on the devices (except for transformers).

15.3 POWER AND POWER FACTOR: DEFINITIONS

In a standard electric installation powered by three sine voltages the following is defined:

Phase Active Power: (n=1,2,3)	$P_n = V_n \cdot I_n \cdot \cos(\Theta_n)$
Phase Apparent Power: (n=1,2,3)	$S_n = V_n \cdot I_n$
Phase Reactive Power: (n=1,2,3)	$Q_n = \sqrt{S_n^2 - P_n^2}$
Phase Power Factor: (n=1,2,3)	$P_{F_n} = \frac{P_n}{S_n}$
Total Active Power:	$P_{TOT} = P_1 + P_2 + P_3$
Total Reactive Power:	$Q_{TOT} = Q_1 + Q_2 + Q_3$
Total Apparent Power:	$S_{TOT} = \sqrt{P_{TOT}^2 + Q_{TOT}^2}$
Total Power Factor:	$P_{F_{TOT}} = \frac{P_{TOT}}{S_{TOT}}$

Where:

V_n = RMS value of voltage between phase n and Neutral.

I_n = RMS value of n phase current.

f_n = Phase displacement angle between voltage and current of n phase.

In presence of distorted voltages and currents the previous relations vary as follows:

Phase Active Power: (n=1,2,3)	$P_n = \sum_{k=1}^{\infty} V_{kn} I_{kn} \cos(\Theta_{kn})$
Phase Apparent Power: (n=1,2,3)	$S_n = V_{nN} \cdot I_n$
Phase Reactive Power: (n=1,2,3)	$Q_n = \sqrt{S_n^2 - P_n^2}$
Phase Power Factor: (n=1,2,3)	$P_{Fn} = \frac{P_n}{S_n}$
Distorted Power Factor: (n=1,2,3)	$dPF_n = \cos f_{In} = \text{phase displacement between the fundamentals of voltage and current}$
Total Active Power:	$P_{TOT} = P_1 + P_2 + P_3$
Total Reactive Power:	$Q_{TOT} = Q_1 + Q_2 + Q_3$
Total Apparent Power:	$S_{TOT} = \sqrt{P_{TOT}^2 + Q_{TOT}^2}$
Total Power Factor:	$P_{FTOT} = \frac{P_{TOT}}{S_{TOT}}$

Where:

V_{kn} = RMS value of kth

voltage harmonic between n phase and Neutral.

I_{kn} = RMS value of kth current harmonic of n phase.

f_{kn} = Phase displacement

angle between kth voltage harmonic and kth current harmonic of n phase.

Note:

It is to be noted that the expression of the phase Reactive Power with non sine waveforms, would be wrong. To understand this, it may be useful to consider that both the presence of harmonics and the presence of reactive power produce, among other effects, an increase of line power losses due to the increased current RMS value. With the above given relation the increasing of power losses due to harmonics is added to that introduced by the presence of reactive power. In effect, even if the two phenomena together contribute to the increase of power losses in line, it is not true in general that these causes of the power losses are in phase between each other and therefore can be added one to the other mathematically. The above given relation is justified by the relative simplicity of calculation of the same and by the relative discrepancy between the values obtained using this relation and the true value.

It is to be noted moreover, how in case of an electric installation with harmonics, another parameter called distorted Power Factor (dPF) is defined. In practice, this parameter represents the theoretical limit value that can be reached for Power Factor if all the harmonics could be eliminated from the electric installation.

15.3.1 Conventions on Powers and Power Factors

As for the recognition of the type of reactive power, of the type of power factor and of the direction of the active power, the below conventions must be applied. The stated angles are those of phase-displacement of the current compared to the voltage (for example, in the first panel the current is in advance from 0° to 90° compared to the voltage):

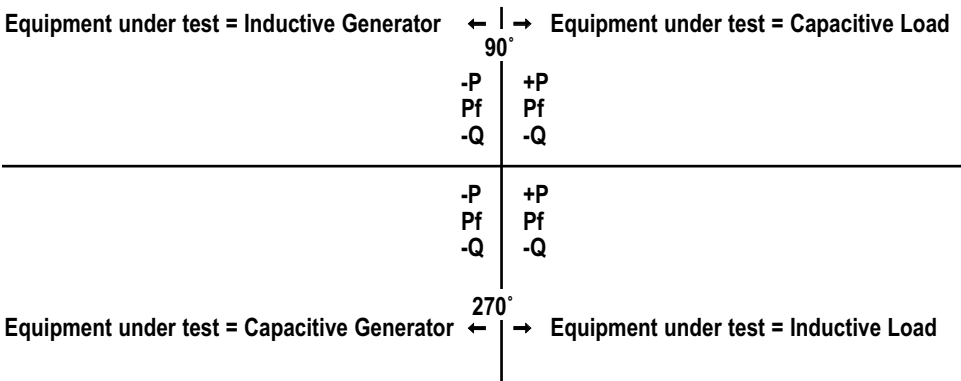

Where:

Symbol	Significance	Remarks
P+	Value of the active power +	Positive parameter (load)
-Pf	Capacitive power factor +	
Pf+	Inductive power factor +	
-Q	Value of the capacitive reactive power +	
Q+	Value of the inductive reactive power +	
P-	Value of the active power -	Negative parameter (generator)
-Pf	Capacitive power factor -	
+Pf	Inductive power factor -	
-Q	Value of the capacitive reactive power -	
+Q	Value of the inductive reactive power -	

Value	Significance
P	The active power (positive or negative) is defined in the panel and therefore acquires the value of the active power in that moment.
Q	The reactive power (inductive or capacitive, positive or negative) is defined in the panel and therefore acquires the value of the reactive power in that moment.
Pf	The power factor (inductive or capacitive, positive or negative) is defined in the panel and therefore acquires the value of the power factor in that moment.
0	The active power (positive or negative) or the reactive power (inductive or capacitive, positive or negative) is NOT defined in the panel and therefore acquires a null value.
-1	The power factor (inductive or capacitive, positive or negative) is NOT defined in the panel.

15.3.2 3 Phase 3 Wire System

In the electrical systems distributed without neutral, the phase voltages and the power factors and phase $\cos\phi$ lose importance. Only the phase to phase voltages, the phase currents and the total powers remain defined.

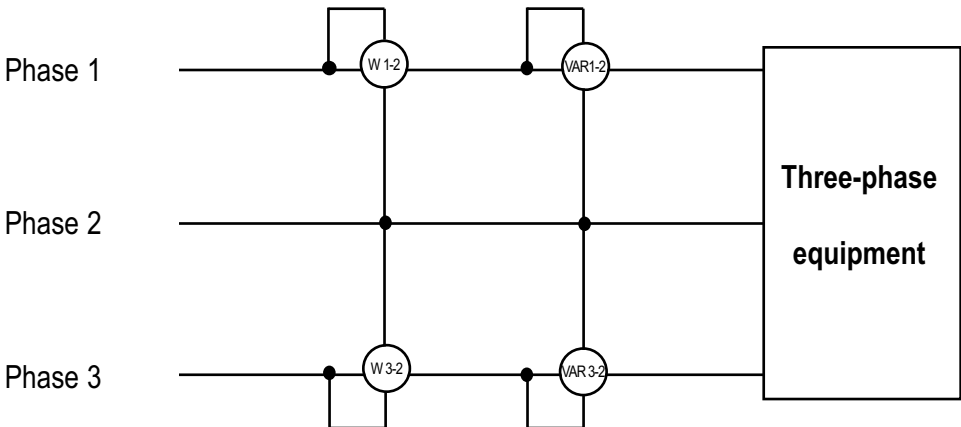

In this case the potential of one of the three phases (for example, phase 2) is taken on as reference potential. The total values of the active, reactive and apparent power are expressed as sum of the indications of the couples of Wattmeters, VARmeters and VAmeters.

$$\begin{aligned}
 P_{\text{TOT}} &= W_{1-2} + W_{3-2} \\
 Q_{\text{TOT}} &= \text{VAR}_{1-2} + \text{VAR}_{3-2} \\
 S_{\text{TOT}} &= \sqrt{(W_{1-2} + W_{3-2})^2 + (\text{VAR}_{1-2} + \text{VAR}_{3-2})^2}
 \end{aligned}$$

15.4 MEASURING METHOD: OUTLINES

The instrument is able to measure: voltages, currents, active powers, inductive and capacitive reactive powers, apparent powers, inductive and capacitive power factors, analog or impulse parameters. All these parameters are analyzed in a digital way: for each phase (voltage and current), 6 x 128 samples are acquired on a module of 16 x 20ms, repeated for the three phases.

15.4.1 Integration Periods

The storage of all the data would require a huge amount of memory. Therefore, we've tried to find out a storage method that compresses the information to be memorized, while still providing a significant amount of data. The chosen method is that of integration. After a certain period called the "integration period", which can be set from 5 seconds to 60 minutes, the instrument extracts from the sampled values the following:

- Minimum value of the parameter during the integration period (harmonics excluded)
- Medium value of the parameter (intended as arithmetic average of all the values registered during the integration period)
- Maximum value of the parameter during the integration period (harmonics excluded)

Only this information (repeated for each parameter to be memorized) is saved in the memory along with starting time and date of the integration period. Once these data are memorized, the instrument restarts to take measurements for a new period.

15.4.2 Power Factor Calculations

According to the standards in force, the medium power factor can't be calculated as average of the instantaneous power factors. It must be obtained from the medium values of active and reactive power. Each single medium power factor (of phase or total) is therefore calculated, at the end of each integration period, on the medium value of the corresponding powers independently on the fact that they must be registered or not. Besides, for a better analysis of the type of load present on the line and in order to have terms of comparison when studying the invoicing of the low $\cos\phi$, the values of inductive and capacitive $\cos\phi$ are treated as independent parameters.

16. AFTER-SALE SERVICE

16.1 WARRANTY

Congratulations! Your new instrument has been quality crafted according to quality standards and contains quality components and workmanship. It has been inspected for proper operation of all of its functions and tested by qualified factory technicians according to the long-established standards of our company.

Your instrument has a limited warranty against defective materials and/or workmanship for one year from the date of purchase provided that, in the opinion of the factory, the instrument has not been tampered with or taken apart.

Should your instrument fail due to defective materials, and/or workmanship during this one-year period, a no charge repair or replacement will be made to the original purchaser. Please have your dated bill of sale, which must identify the instrument model number and serial number and call the number listed below:

AMPROBE / Repair Department

Phone: 954-499-5400 • Toll Free: 800-327-5060 • Fax: 866-287-7222

Website: www.Amprobe.com

Please obtain an RMA number before returning product for repair.

Outside the U.S.A. the local representative will assist you. Above limited warranty covers repair and replacement of instrument only and no other obligation is stated or implied.

16.2 SERVICE

If the instrument fails to operate, check battery, test leads, etc and replace as necessary. If the instrument still malfunctions, please call the phone number listed below:

AMPROBE / Repair Department

Phone: 954-499-5400 • Toll Free: 800-327-5060 • Fax: 866-287-7222

Website: www.Amprobe.com

Outside the U.S.A. the local Amprobe representative will assist you.



Tel: 954-499-5400
Toll Free: 1-800-327-5060
Fax: 1-866-287-7222
www.Amprobe.com

100795 Rev.B