

- Easy Evaluation for the SP7651ER
12V Input, 0 to 3A Output Synchronous
Buck Converter
- Built in Low RDS(ON) Power FETs
- UVLO Detects Both Vcc and VIN
- Highly Integrated Design, Minimal
Components
- High Efficiency: 88%
- Feature Rich: UVIN, Programmable
Softstart, External Vcc Supply and
Output Dead Short Circuit Shutdown
Protection

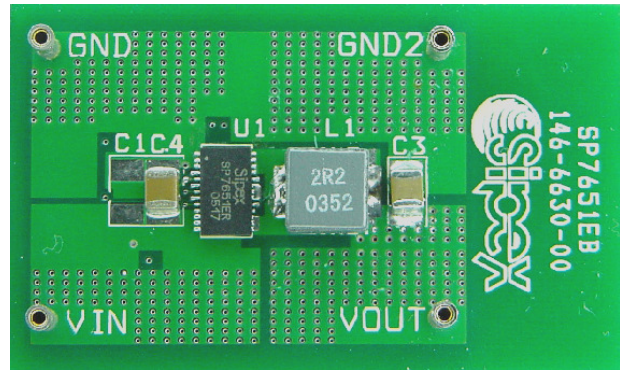

SP7651EB SCHEMATIC

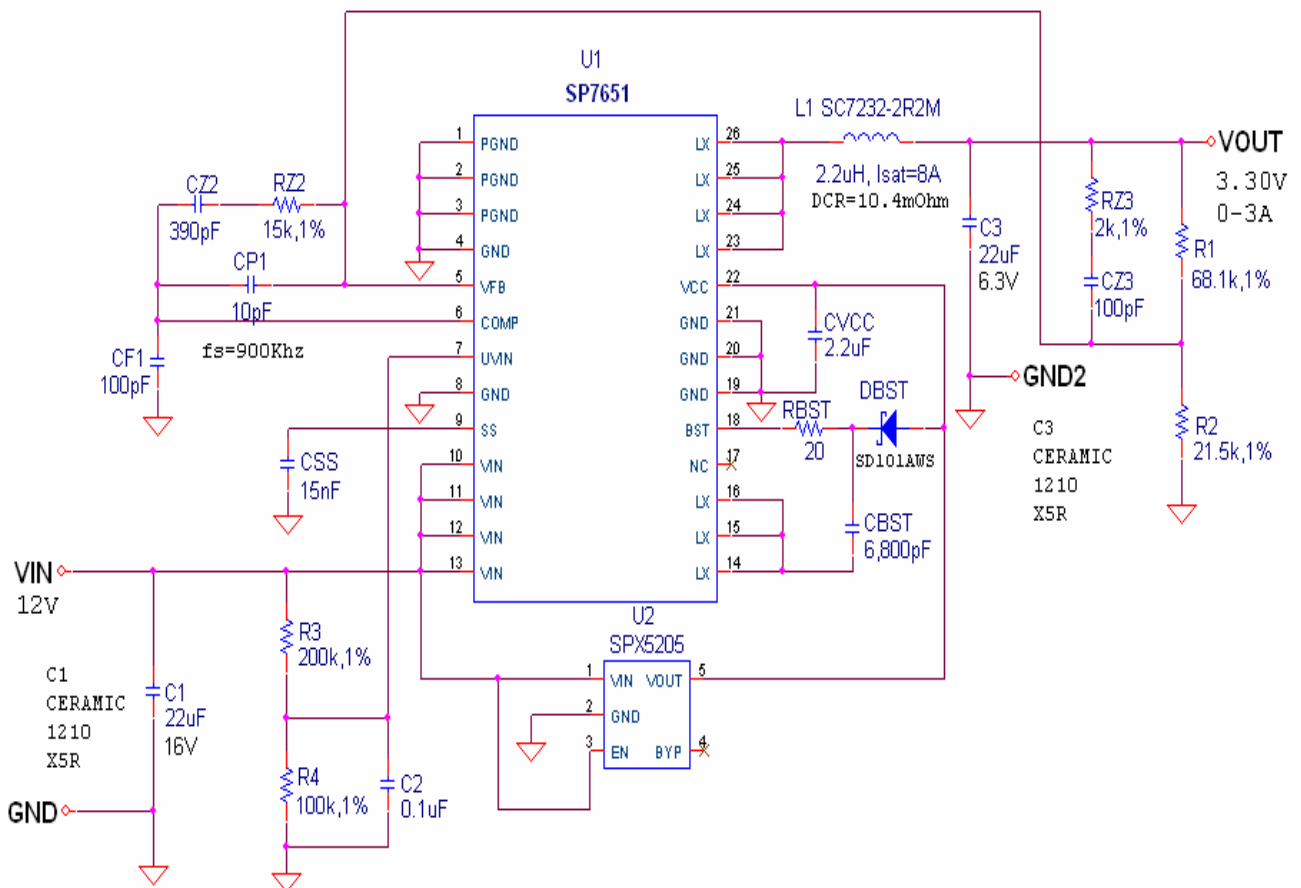

USING THE EVALUATION BOARD

1) Powering Up the SP7651EB Circuit

Connect the SP7651 Evaluation Board with an external +12V power supply. Connect with short leads and large diameter wire directly to the “VIN” and “GND” posts. Connect a Load between the VOUT and GND2 posts, again using short leads with large diameter wire to minimize inductance and voltage drops.

2) Measuring Output Load Characteristics

VOUT ripple can best be seen touching the probe tip to the pad for C3 and the scope GND collar touching the GND side of C3 using short wrapped wire around the collar – avoid a GND lead on the scope which will increase noise pickup.

3) Using the Evaluation Board with Different Output Voltages

While the SP7651 Evaluation Board has been tested and delivered with the output set to 3.30V, by simply changing one resistor, R2, the SP7651 can be set to other output voltages. The relationship in the following formula is based on a voltage divider from the output to the feedback pin VFB, which is set to an internal reference voltage of 0.80V. Standard 1% metal film resistors of surface mount size 0603 are recommended.

$$V_{OUT} = 0.80V (R1 / R2 + 1) \Rightarrow R2 = R1 / [(V_{out} / 0.80V) - 1]$$

Where R1 = 68.1KΩ and for VOUT = 0.80V setting, simply remove R2 from the board. Furthermore, one could select the value of the R1 & R2 combination to meet the exact output voltage setting by restricting R1 resistance range such that 50KΩ ≤ R1 ≤ 100KΩ for overall system loop stability.

Note that since the SP7651 Evaluation Board design was optimized for 12V down conversion to 3.30V, changes of output voltage and/or input voltage will alter performance from the data given in the Power Supply Data section. In addition, the SP7651ER provides short circuit protection by sensing VOUT at GND.

POWER SUPPLY DATA

The SP7651ER is designed with a very accurate 1.0% reference over line, load and temperature. Figure 1 data shows a typical SP7655 Evaluation Board Efficiency plot, with efficiencies to 87% (including generation of 5V Vcc) and output currents to 3A. SP7651ER Load Regulation is shown in Figure 2 to have only 0.5% change in output voltage from 0.5A load to 3A load. Figures 3 and 4 illustrate a 1.5A to 3A and 0A to 3A Load Step. Start-up Responses in Figures 5, 6 and 7 show a controlled start-up with different output load behavior when power is applied where the input current rises smoothly as the Softstart ramp increases. In Figure 8 the SP7651ER is configured for hiccup mode in response to an output dead short circuit condition and will Soft-start until the over-load is removed. Figure 9 and 10 show output voltage ripple less than 25mV at no load to 3A load.

While data on individual power supply boards may vary, the capability of the SP7651ER of achieving high accuracy over a range of load conditions shown here is quite impressive and desirable for accurate power supply design.

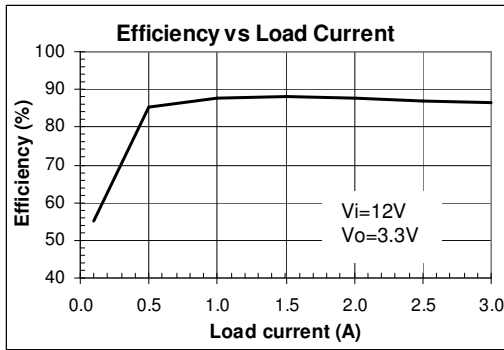

Figure 1. Efficiency vs Load

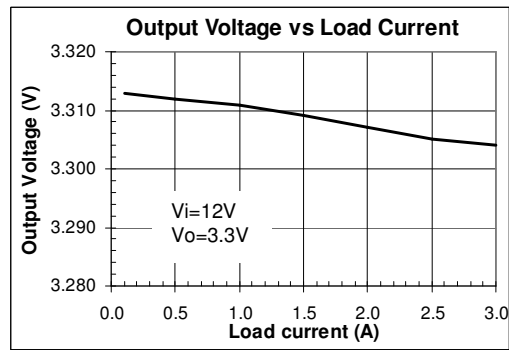

Figure 2. Load Regulation

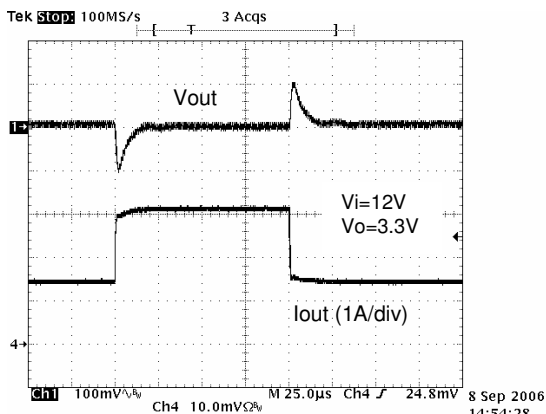

Figure 3. Load Step Response: 1.5->3A

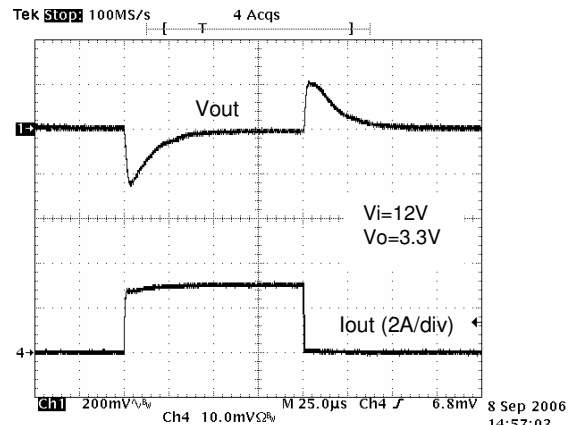

Figure 4. Load Step Response: 0->3A

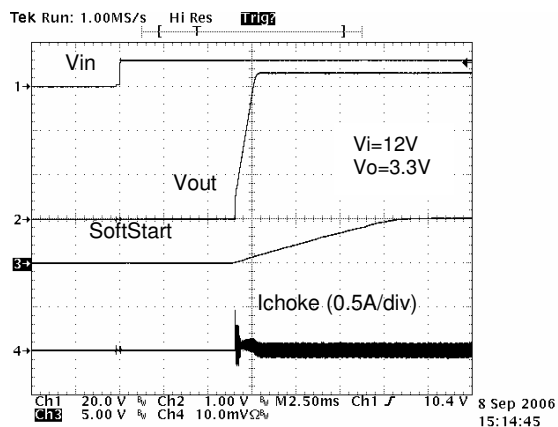

Figure 5. Start-Up Response: No Load

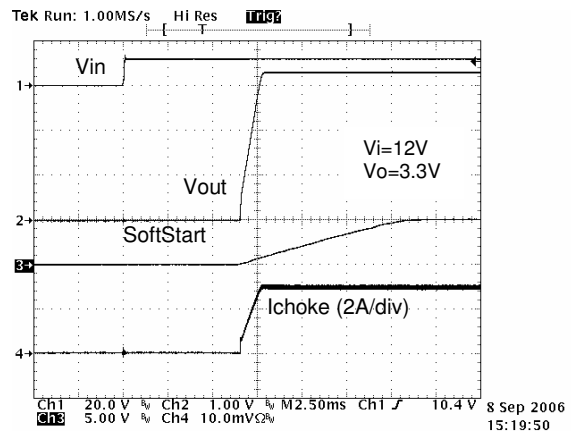

Figure 6. Start-Up Response: 3A Load

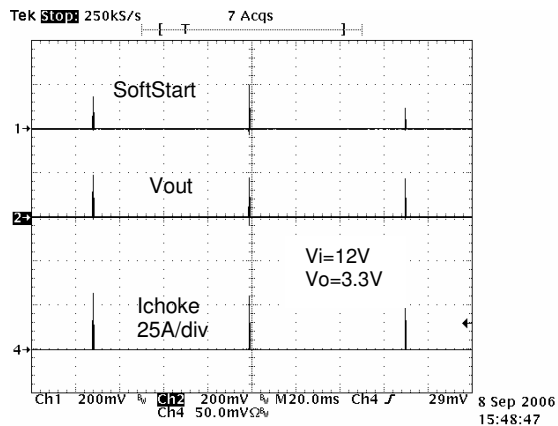

Figure 7. Output Load Short Circuit

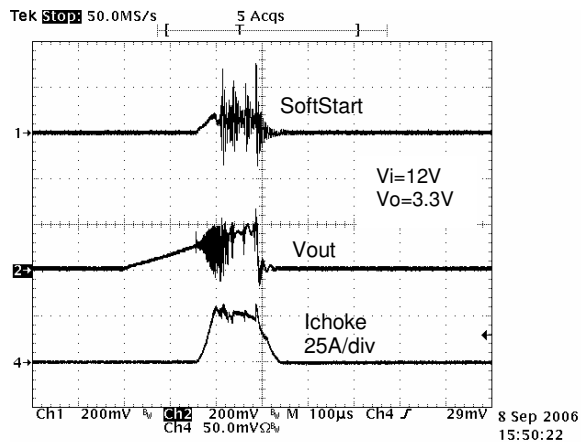

Figure 8. Output Load Short Circuit (Zoom-in)

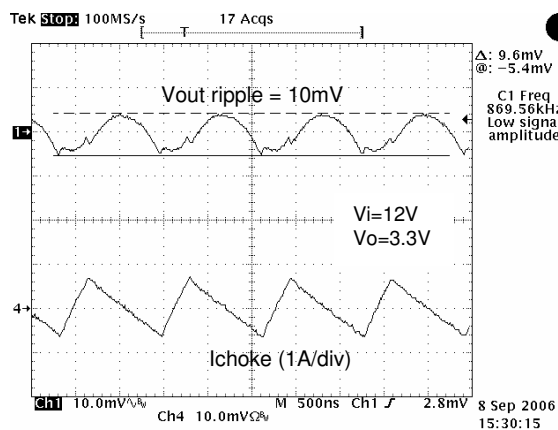

Figure 9. Output Ripple: No Load

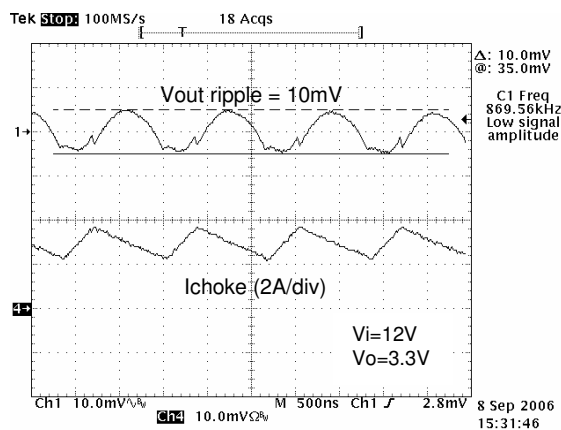
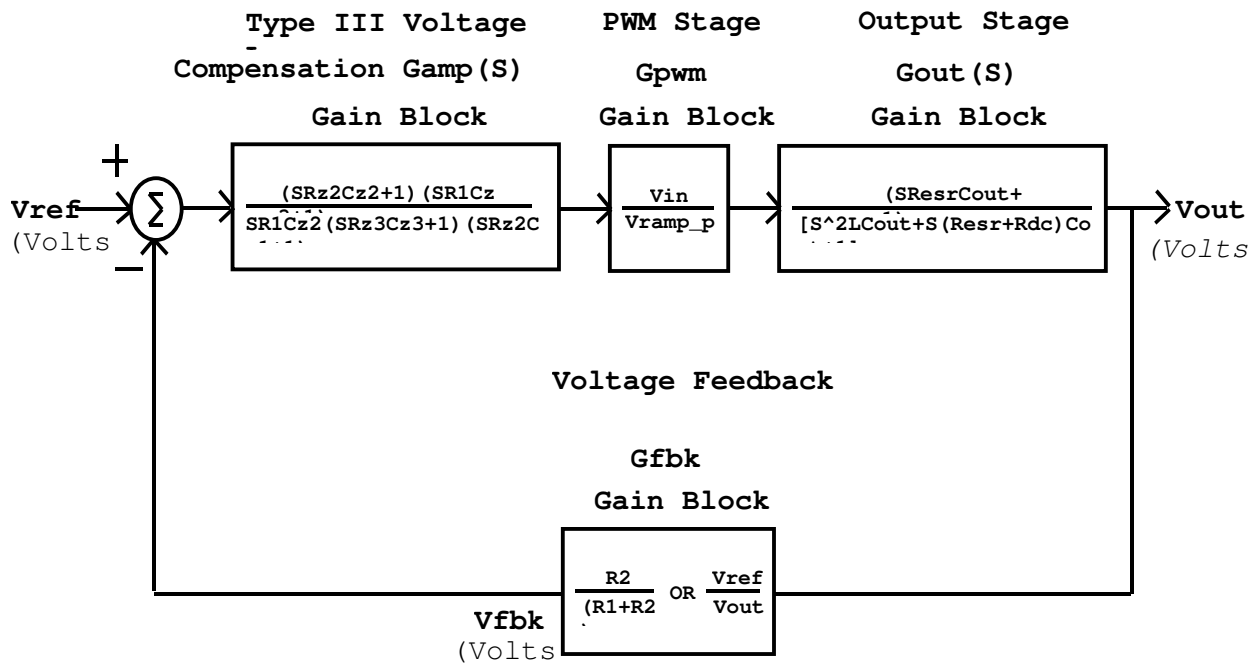

Figure 10. Output Ripple: 3A Load

TYPE III LOOP COMPENSATION DESIGN

The open loop gain of the SP7651EB can be divided into the gain of the error amplifier **Gamp(s)**, PWM modulator **Gpwm**, buck converter output stage **Gout(s)**, and feedback resistor divider **Gfbk**. In order to cross over at the selecting frequency **fco**, the gain of the error amplifier must compensate for the attenuation caused by the rest of the loop at this frequency. The goal of loop compensation is to manipulate the open loop frequency response such that its gain crosses over 0dB at a slope of -20dB/dec . The open loop crossover frequency should be higher than the ESR zero of the output capacitors but less than 1/5 to 1/10 of the switching frequency **fs** to insure proper operation. Since the SP7651EB is designed with Ceramic Type output capacitors, a Type III compensation circuit is required to give a phase boost of 180° in order to counteract the effects of the output **LC** underdamped resonance double pole frequency.



Definition

Resr := Output Capacitor Equivalent Series Resistance

Rdc := Output Inductor DC Resistance

Vramp_pp := SP7651 Internal RAMP Amplitude Peak to Peak Voltage

Condition

$Cz2 \gg Cp1$ and $R1 \gg Rz3$

Output Load Resistance \gg Resr and Rdc

Figure 11. Voltage Mode Control Loop with Loop Dynamic for Type III Compensation

The simple guidelines for positioning the poles and zeros and for calculating the component values for Type III compensation are as follows:

- a. Choose **fco** = $f_s / 5$
- b. Calculate **fp_LC**
 $f_{p_LC} = 1 / [2\pi (L \bullet C) ^{1/2}]$
- c. Calculate **fz_ESR**
 $f_{z_ESR} = 1 / 2\pi (R_{ESR}) \bullet (C_{OUT})$
- d. Select **R1** component value such that $50k\Omega \leq R1 \leq 100k\Omega$
- e. Calculate **R2** base on the desired V_{OUT}
 $R2 = R1 / [(V_{OUT} / 0.80V) - 1]$
- f. Select the ratio of **Rz2 / R1** gain for the desired gain bandwidth
 $Rz2 = R1 (V_{RAMP_PP} / V_{IN_MAX}) (f_{co} / f_{p_LC})$
- g. Calculate **Cz2** by placing the zero at $1/2$ of the output filter pole frequency
 $Cz2 = 1 / [\pi (Rz2) \bullet (f_{p_LC})]$
- h. Calculate **Cp1** by placing the first pole at ESR zero frequency
 $Cp1 = 1 / [2\pi (Rz2) \bullet (f_{z_ESR})]$
- i. Calculate **Rz3** by setting the second pole at $1/2$ of the switching frequency and the second zero at the output filter double pole frequency
 $Rz3 = 2 (R1) (f_{p_LC}) / f_s$
- j. Calculate **Cz3** from **Rz3** component value above
 $Cz3 = 1 / \pi (Rz3) \bullet (f_s)$
- k. Choose $100pF \leq C_{f1} \leq 220pF$ to stabilize the SP7651ER internal Error Amplifier

Note: Loop Compensation component calculations discussed in this section are further elaborated in the application note #ANP16, "**Loop Compensation of Voltage-Mode Buck Converters**".

These calculations shown here can be quickly iterated with the Type III Loop Compensation Calculator on the web at:
www.sipex.com/files/Application-Notes/TypeIIICalculator.xls

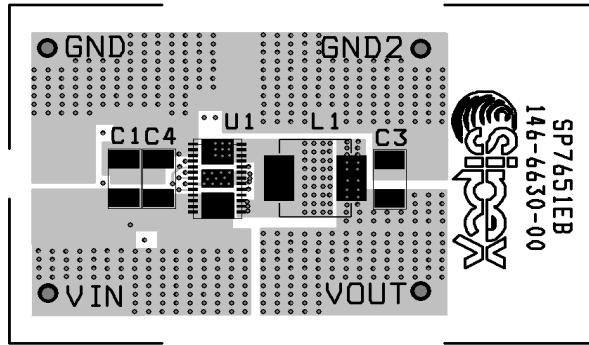

Figure 12. SP7651EB Layout Top Side & Component Placement

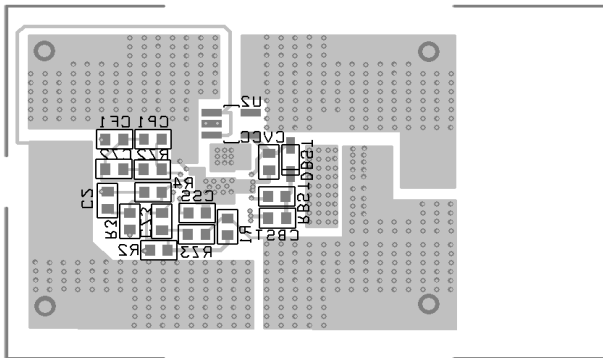

Figure 13. SP7651EB PC Layout Bottom Side & Component Placement

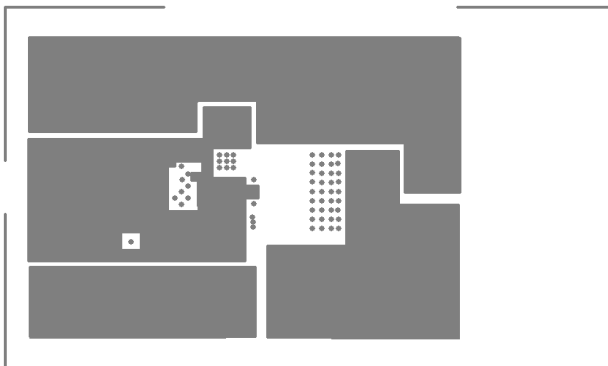

Figure 14. SP7651EB PC Layout Inner Layer 1

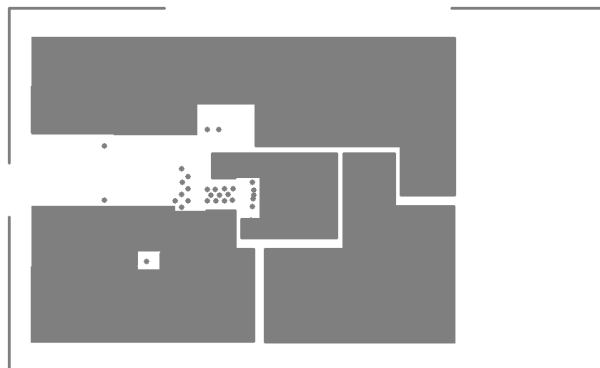

Figure 15. SP7651EB PC Layout Inner Layer 2

Table 1: SP7651EB List of Materials

REF. DES.	QTY	MANUFACTURER NAME	Manufacturer Part Number	SIZE	DESCRIPTION
U1	1	SIPEX	SP7651ER	DFN-26	2-FETs Buck Ctrl
U2	1	Sipex	SPX5205M5-5.0	SOT-23-5	150mA LDO Voltage Regulator
DBST	1	Diodes Inc.	SD101AWS-7	SOD-323	Schottky Diode, 15mA
L1	1	Intertechnical	SC7232-2R2M	7 X 7mm	Inductor, 2.2uH, 8A, 10.4mohm
C3	1	TDK CORPORATION	C3225X5R0J226M	1210	Capacitor, Ceramic, 22uF, 6.3V, X5R, 20%
C4	1	TDK CORPORATION	C3225X5R1C226M	1210	Capacitor, Ceramic, 22uF, 16V, X5R, 20%
CVCC	1	TDK CORPORATION	C1608X5R1A225K	0603	Capacitor, Ceramic, 2.2uF, 10V, X5R, 10%
C2	1	TDK CORPORATION	C1608X7R1H104K	0603	Capacitor, Ceramic, 0.1uF, 50V, X7R, 10%
CBST	1	AVX CORPORATION	06035C682KAT2A	0603	Capacitor, Ceramic, 6.8nF, 50V, X7R, 10%
CSS	1	ROHM	MCH185CN153KK	0603	Capacitor, Ceramic, 15nF, 50V, X7R, 10%
CP1	1	AVX CORPORATION	06035A100JAT2A	0603	Capacitor, Ceramic, 10pF, 50V, C0G, 5%
CZ2	1	AVX CORPORATION	06035A391JAT2A	0603	Capacitor, Ceramic, 390pF, 50V, C0G, 5%
CZ3	1	AVX CORPORATION	06035A101JAT2A	0603	Capacitor, Ceramic, 100pF, 50V, C0G, 5%
CF1	1	ROHM	MCH185A101JK	0603	Capacitor, Ceramic, 100pF, 50V, C0G, 5%
RZ2	1	VISHAY DALE	CRCW0603-1502FRT1	0603	Resistor, 15K, 1/16W, 1%
R2	1	SEI ELECTRONICS	RMC-1/16W-21.5K-1%-TR	0603	Resistor, 21.5K, 1/16W, 1%
RZ3	1	VISHAY DALE	CRCW0603-2001FRT1	0603	Resistor, 2K, 1/16W, 1%
R1	1	VISHAY DALE	CRCW0603-6812FRT1	0603	Resistor, 68.1K, 1/16W, 1%
R3	1	VISHAY DALE	CRCW0603-2003FRT1	0603	Resistor, 200K, 1/16W, 1%
R4	1	VISHAY DALE	CRCW0603-1003FRT1	0603	Resistor, 100K, 1/16W, 1%
RBST	1	ROHM	MCR03EZPEFX20R0	0603	Resistor, 20, 1/16W, 1%
VIN, VOUT, GND, GND2	4	Vector Electronic	K24C/M	.042 Dia	Input/Output Terminal Posts

ORDERING INFORMATION

Model	Temperature Range	Package Type
SP7651EB.....	-40°C to +85°C.....	SP7651 Evaluation Board
SP7651ER.....	-40°C to +85°C.....	26-pin DFN