



maxiFLOW™ Heat Sink for Eighth Brick DC-DC Converter

ATS PART # ATS-1179-C1-R0

Features & Benefits

- » High performance maxiFLOW™ design features less pressure drop and more surface area that maximizes the effective convection (air) cooling
- » Hole pattern fits standard eighth power brick modules
- » Pre-assembled with Chomerics T766 phase change material
- » Heat sink assembly packaged with 3 sets of screws (M3 Philips Pan Head) at 5, 6 and 8 mm lengths

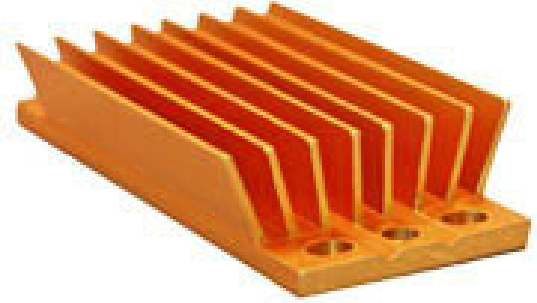

*Image is for illustration purposes only.

Assembly Part Number	Length (mm)
4 Screws per Set	
ATS-1179-C2-R0	5
ATS-1179-C3-R0	6
ATS-1179-C4-R0	8

Thermal Performance

AIR VELOCITY		6.19THERMAL RESISTANCE	
FT/MIN	M/S	°C/W (UNDUCTED FLOW)	°C/W (DUCTED FLOW)
200	1.0	7.3	3.4
300	1.5	4.9	
400	2.0	4.0	
500	2.5	3.4	
600	3.0	3.1	
700	3.5	2.9	
800	4.0	2.7	

Product Details

DIMENSION A	DIMENSION B	DIMENSION C	DIMENSION D	DIMENSION E	DIMENSION F	DIMENSION G	DIMENSION H	DIMENSION I	INTERFACE MATERIAL	FINISH
58.0 mm	23.0 mm	11.4 mm	30.2 mm	15.2 mm	50.8 mm	12.8 mm	50.4 mm	51.3 mm	CHOMERICS T766	GOLD ANODIZED

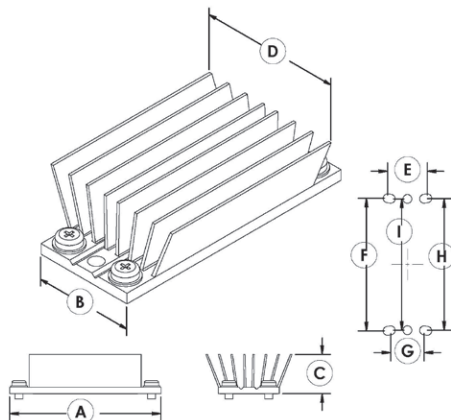

NOTES:

- 1) Thermal performance data are provided for reference only. Actual performance may vary by application.
- 2) ATS reserves the right to update or change its products without notice to improve the design or performance.
- 3) Standard lead time is 4-6 weeks ARO.
- 4) Contact ATS to learn about custom options available.
- 5) Dimension C = heat sink height from bottom of the base to the top of the fin field.
- 6) Dimension D = Fin Tip to Fin Tip
- 7) Dimension E = Hole Width
- 8) Dimension F = Hole Length
- 9) Dimension G = Short Hole Width
- 10) Dimension H = Short Hole Length
- 11) Dimension I = Center Hole



ATS ADVANCED THERMAL SOLUTIONS, INC.
Innovations in Thermal Management®

For further technical information, please contact Advanced Thermal Solutions, Inc.

89-27 ACCESS ROAD, NORWOOD, MA 02062 USA | T: 781.769.2800 F: 781.769.9979 | WWW.QATS.COM

REV4_0117