

## RONDA-W

~45° wide beam with holder A compatible with 3rd party connectors from TE, Bender Wirth and IDEAL

### TECHNICAL SPECIFICATIONS:

Dimensions	Ø 69.9 mm
Height	14 mm
Fastening	socket
Colour	white
Box size	
Box weight	0 kg
Quantity in Box	420 pcs
ROHS compliant	yes ⓘ

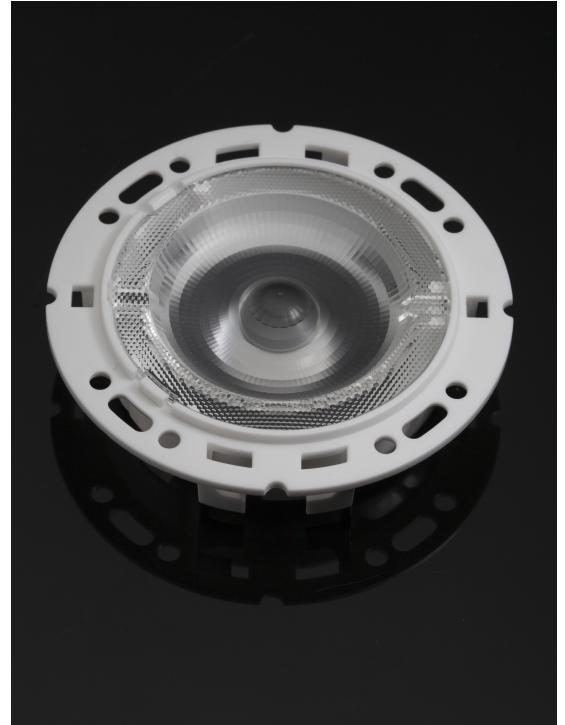

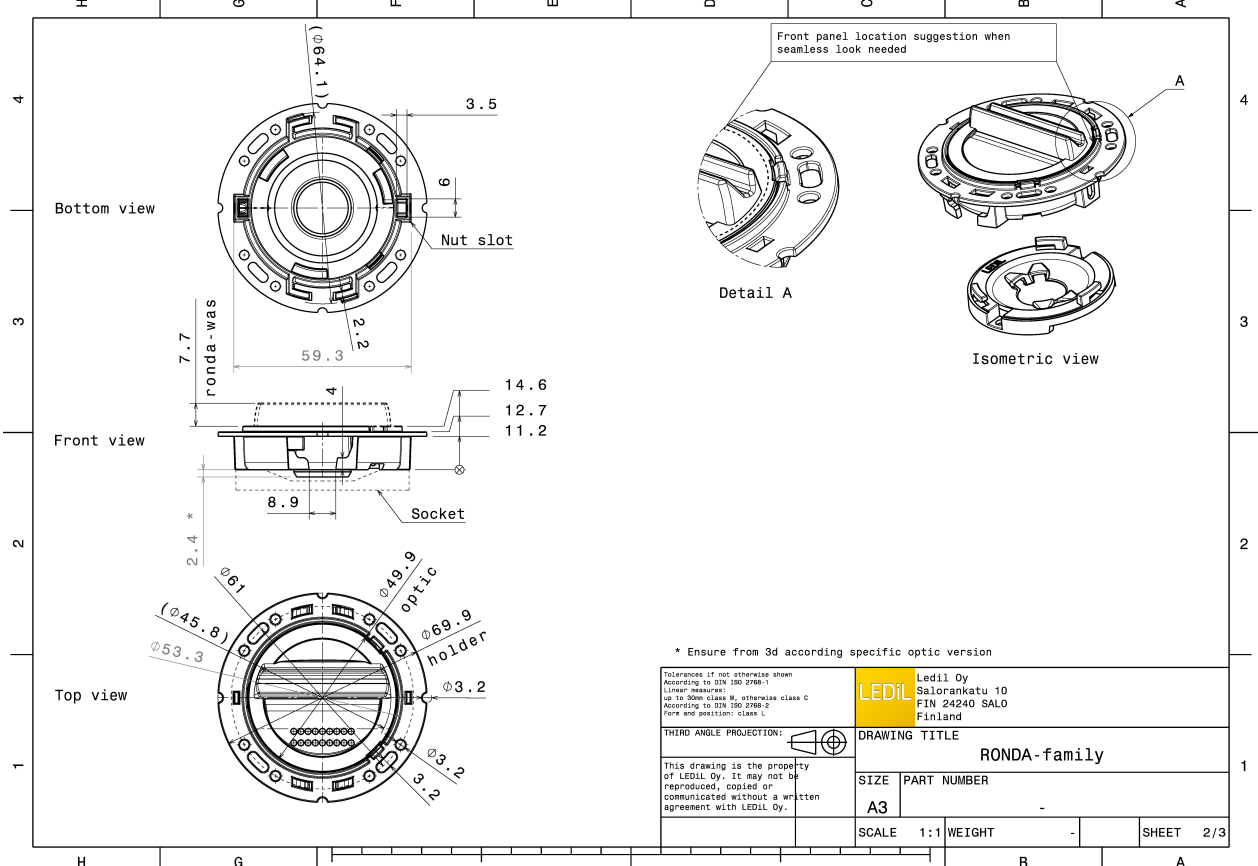
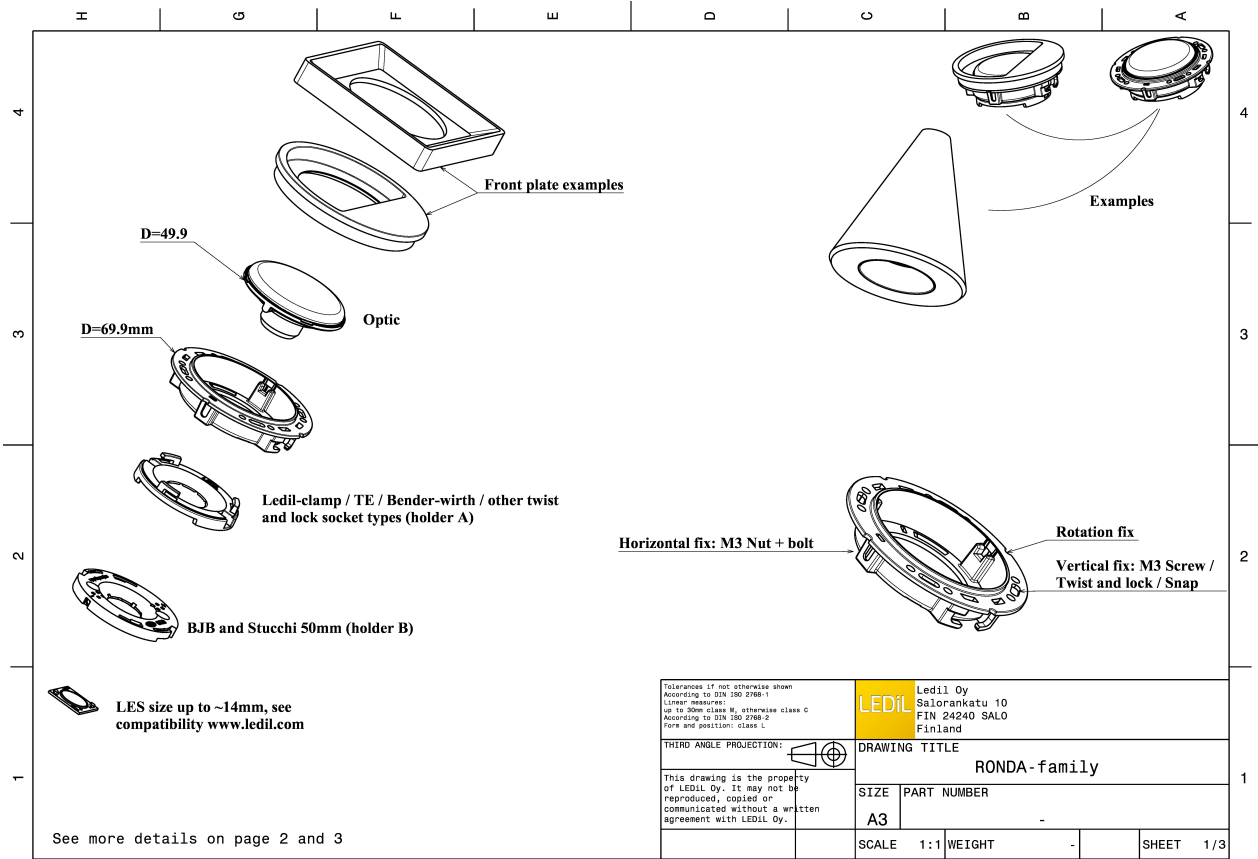

### MATERIAL SPECIFICATIONS:

Component	Type	Material	Colour
RONDA-W	Lens	PMMA	clear
RONDA-HLD-A	Holder	PC	white

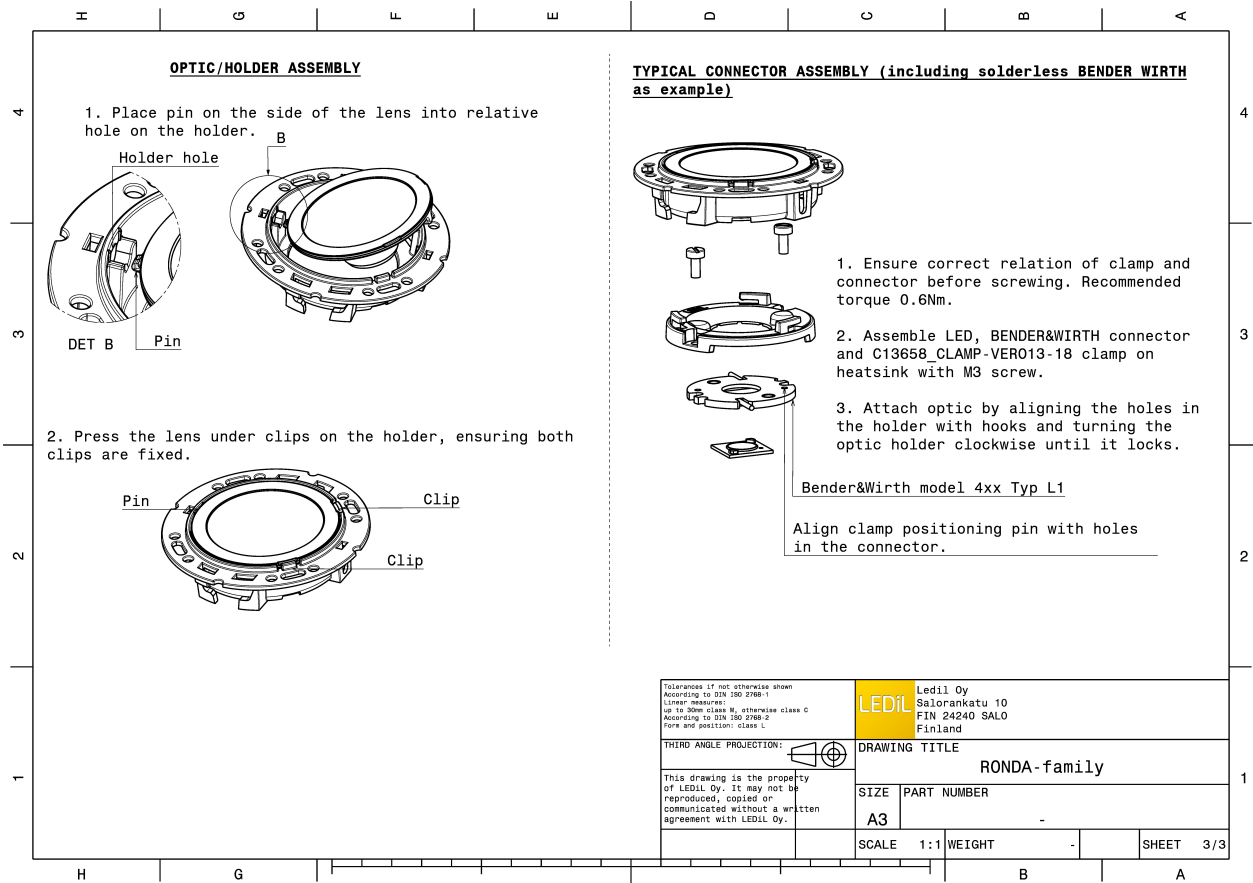

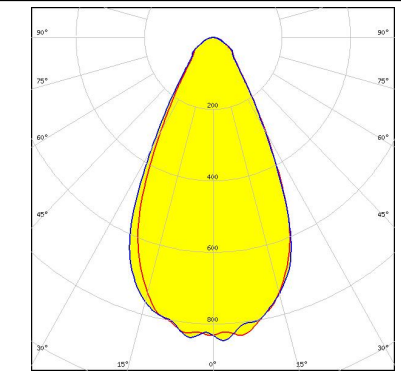
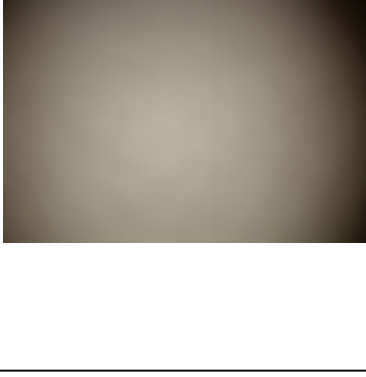
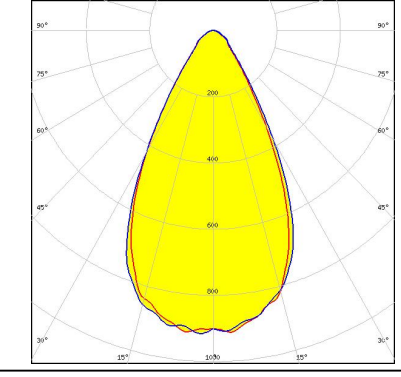
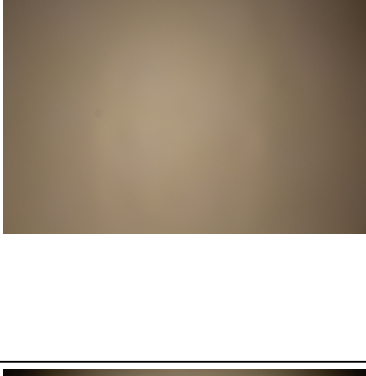
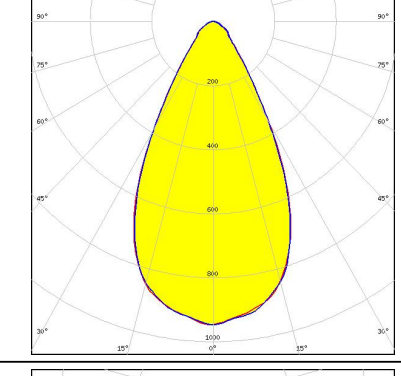

#### PHOTOMETRIC DATA (MEASURED):

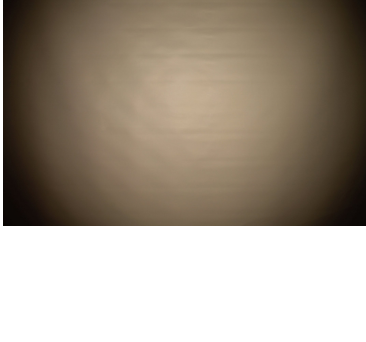
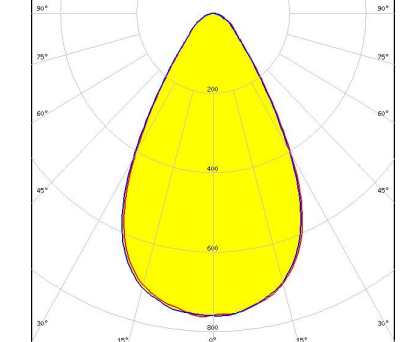
<p>bridgelux.</p> <p>LED V13 Gen7</p> <p>FWHM 54.0°</p> <p>Efficiency 84 %</p> <p>Peak intensity 0.850 cd/lm</p> <p>Required components: TE: 2213254-2 + OPTIC CLIP Z50 TYPE1 2213194-1</p>		
<p>bridgelux.</p> <p>LED Vero SE 13</p> <p>FWHM 56.0°</p> <p>Efficiency 89 %</p> <p>Peak intensity 0.920 cd/lm</p> <p>Required components: C16402_CLAMP-VEROSE-13-18</p>		
<p>bridgelux.</p> <p>LED VERO13</p> <p>FWHM 55.0°</p> <p>Efficiency 90 %</p> <p>Peak intensity 0.950 cd/lm</p> <p>Required components: C13658_CLAMP-VERO13-18</p>		
<p><b>CREE</b> </p> <p>LED CMA1840</p> <p>FWHM 62.0°</p> <p>Efficiency 90 %</p> <p>Peak intensity 0.760 cd/lm</p> <p>Required components: C14123_CLAMP-CXA15-18</p>		

### PHOTOMETRIC DATA (MEASURED):

**CREE** 

LED CXA/B 1816 & CXA/B 1820 & CXA 1850

FWHM 56.0°

Efficiency 91 %

Peak intensity 1.000 cd/lm

Required components:

LEDiL: C14123\_CLAMP-CXA15-18

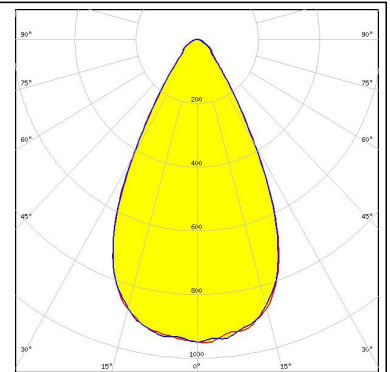

**PHILIPS**

LED Fortimo SLM L15 Standard

FWHM 57.0°

Efficiency 83 %



Peak intensity 0.710 cd/lm

Required components:

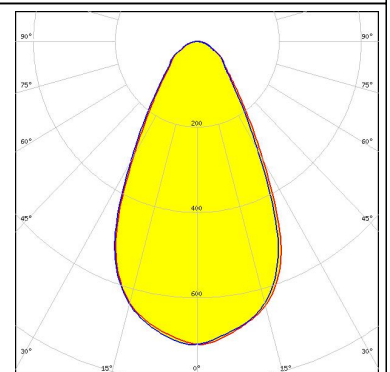
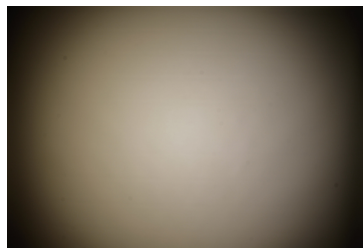
TE: OPTIC CLIP Z50 TYPE1 2213194-1

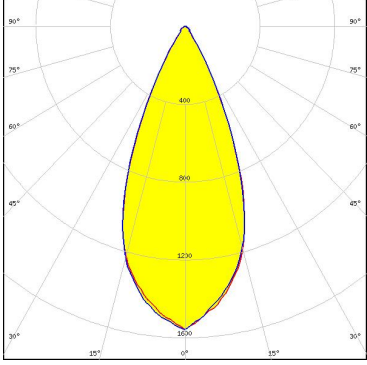

#### PHOTOMETRIC DATA (SIMULATED):

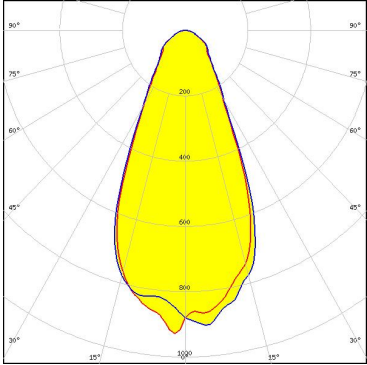
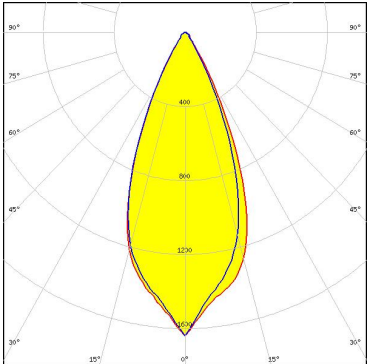
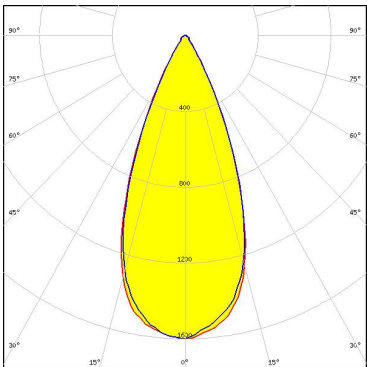
<p> <b>LED</b> V10 Gen6</p> <p><b>FWHM</b> 44.0°</p> <p><b>Efficiency</b> %</p> <p><b>Peak intensity</b> 1.560 cd/lm</p> <p><b>Required components:</b> C13658_CLAMP-VERO13-18 Bender Wirth: 455 Typ L1</p>	
<p> <b>LED</b> V13 Gen7</p> <p><b>FWHM</b> 46.0°</p> <p><b>Efficiency</b> 83 %</p> <p><b>Peak intensity</b> 0.950 cd/lm</p> <p><b>Required components:</b> IDEAL: 50-2103CT + 50-2100AN</p>	
<p><b>CITIZEN</b></p> <p><b>LED</b> CLL02x/CLU02x (LES10)</p> <p><b>FWHM</b> 42.0°</p> <p><b>Efficiency</b> %</p> <p><b>Peak intensity</b> 1.640 cd/lm</p> <p><b>Required components:</b> C13658_CLAMP-VERO13-18 Bender Wirth: 434 Typ L1</p>	
<p><b>CITIZEN</b></p> <p><b>LED</b> CLU710/711</p> <p><b>FWHM</b> 44.0°</p> <p><b>Efficiency</b> %</p> <p><b>Peak intensity</b> 1.600 cd/lm</p> <p><b>Required components:</b> C13658_CLAMP-VERO13-18 Bender Wirth: 470 Typ L1</p>	

### PHOTOMETRIC DATA (SIMULATED):



LED CXA/B 15xx  
FWHM 42.0°  
Efficiency %  
Peak intensity 1.750 cd/lm  
Required components:  
C13658\_CLAMP-VERO13-18  
Bender Wirth: 441 Typ L1

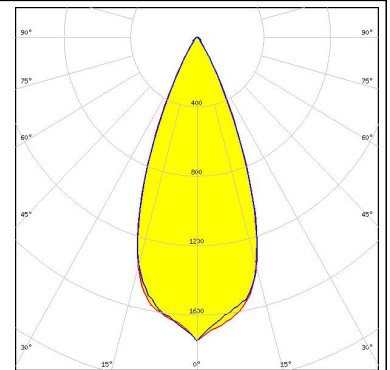

LED CXA/B 1816 & CXA/B 1820 & CXA 1850  
FWHM 48.0°  
Efficiency %  
Peak intensity 1.320 cd/lm  
Required components:  
C13658\_CLAMP-VERO13-18  
Bender Wirth: 437 Typ L1

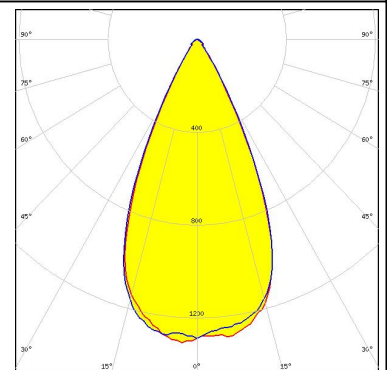

LED CXA/B 1816 & CXA/B 1820 & CXA 1850  
FWHM 45.0°  
Efficiency %  
Peak intensity 1.420 cd/lm  
Required components:  
TE: 2213401-2 + OPTIC CLIP Z50 TYPE1 2213194-1

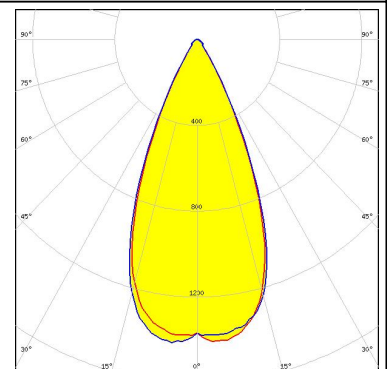

LED LUXEON CoB 1202/1203  
FWHM 43.0°  
Efficiency %  
Peak intensity 1.460 cd/lm  
Required components:  
TE: 2213382-2 + OPTIC CLIP Z50 TYPE1 2213194-1

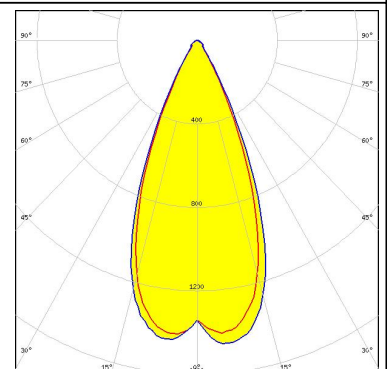

### PHOTOMETRIC DATA (SIMULATED):



LED COB L-Type (LES 9)

FWHM 42.0°

Efficiency %

Peak intensity 1.740 cd/lm

Required components:

TE: 2213382-2 + OPTIC CLIP Z50 TYPE1 2213194-1



LED NSCxL036A

FWHM 36.0°

Efficiency %

Peak intensity 2.370 cd/lm

Required components:

TE: 2213382-2 + OPTIC CLIP Z50 TYPE1 2213194-1



LED Mini Zenigata (GW6BM)

FWHM 40.0°

Efficiency %

Peak intensity 1.770 cd/lm

Required components:

C13658\_CLAMP-VERO13-18

Bender Wirth: 452 Typ L1

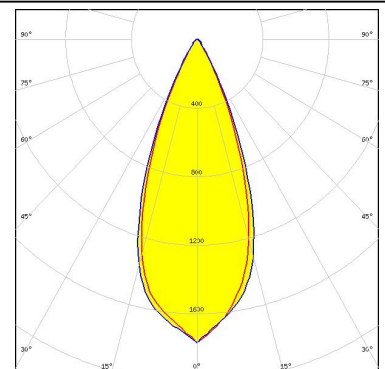

LED SLE G6 LES15

FWHM 55.0°

Efficiency 81 %

Peak intensity 0.890 cd/lm

Required components:

TE: 2213254-2 + OPTIC CLIP Z50 TYPE1 2213194-1

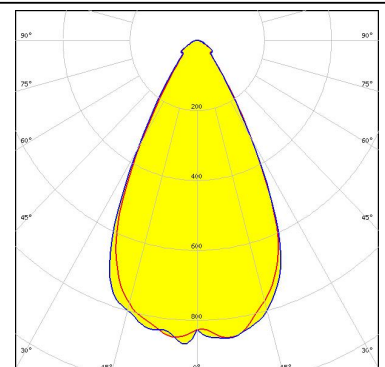



### GENERAL INFORMATION:

NOTE: The typical beam angle will be changed by different color, chip size and chip position tolerance. The typical total beam angle is the full angle measured where the luminous intensity is half of the peak value.

Due to use of high power COB's with this product, special attention to proper thermal design is highly recommended. LEDiL has no liability for direct, indirect or consecutive damages arising from the LEDiL products being used outside of the recommended temperature range.

### MATERIALS:

As part of our continuous research and improvement processes, and to ensure the best possible quality and availability of our products, LEDiL reserves the right to change material grades without notice.

### PRODUCT DATA USER AGREEMENT AND DISCLAIMER:

The measured data in the provided downloadable LEDiL Product Datasheets and Mechanical 2D-Drawings is rounded and provided as reference for planning. LEDiL Oy's optical specifications have been verified by conducting performance testing of the products in accordance with the company's quality system. The reported data are averaged results of multiple measurements with typical variation. LEDiL Oy reserves the right to without prior notification make changes and improvements to its products.

LEDiL Oy assumes neither warranty, nor guarantee nor any other liability of any kind for the contents and correctness of the provided data. The provided data has been generated with highest diligence but the provided data may in reality not represent the complete possible variation range of all intrinsic parameters. Therefore, in certain cases a deviation from the provided data could occur.

LEDiL Oy reserves the right to undertake technical changes of its products without further notification which could lead to changes in the provided data. LEDiL Oy assumes no liability of any kind for the possible deviation from any provided data or any other damage resulting from the usage of the provided data.

The user agrees to this disclaimer and user agreement with the download or usage of the provided files.

#### LEDiL Oy

Joensuunkatu 13  
FI-24240 SALO  
Finland

#### LEDiL Inc.

228 West Page Street  
Suite D  
Sycamore IL 60178  
USA

#### Local sales and technical support

[www.ledil.com/  
where\\_to\\_buy](http://www.ledil.com/where_to_buy)

#### Shipping locations

Salo, Finland  
Hong Kong, China

#### Distribution Partners

[www.ledil.com/  
where\\_to\\_buy](http://www.ledil.com/where_to_buy)