

Description

The **XR77103** features three synchronous wide input range high efficiency buck converters. Each converter is digitally programmable requiring minimal external components thus providing the smallest size solution possible.

The converters can operate in 5V, 9V, and 12V systems and have integrated power switches. The output voltage of each converter can be adjusted by programming the values in the V_{OUT} setting registers through I²C interface. The adjustable range is 0.8 to 6V with 50mV resolution. The output voltage also can be set externally using an external resistor divider. Output sequence among the outputs, soft-start time and the peak inductor current limit are also set through I²C.

The switching frequency of the converters can either be set with I²C or can be synchronized to an external clock connected to SYNC pin if needed. The switching regulators are designed to operate from 300kHz to 2.2MHz. Each converter operates in phase or out-of-phase according to the value in the phase setting register. This can minimize the input filter requirements.

XR77103 features a supervisor circuit that monitors each converter output. PGOOD pin is asserted once sequencing is done, all outputs are reported in regulation, and the reset timer expires. The polarity of the signal is active high.

XR77103 also features a light load pulse skipping mode (PSM). It is set through I²C. The PSM mode allows for a reduction on the input power supplied to the system when the host processor is in stand-by (low activity) mode.

FEATURES

- 4.5V to 14V wide input supply voltage range
- Built-In MOSFET and synchronous rectifier
- I²C programmable supplies
 - Output voltage (0.8 to 6V)
 - Power on sequence
 - Soft-start timing
 - Switching frequency (300kHz to 2.2MHz)
 - Individual current limit
 - Optional power saving mode at light loads
- Non volatile memory (NVM) with up to 10,000 times write operation
- 0.8V, high accuracy reference (1%)
- Current-mode control with simple compensation circuit
- External synchronization
- Power good
- Protection
 - Thermal shutdown
 - Overvoltage transient protection
 - Overcurrent protection
- 32-pin 4mm x 4mm TQFN package

APPLICATIONS

- FPGA and DSP supplies
- Video processor supplies
- Applications processor power

Typical Application

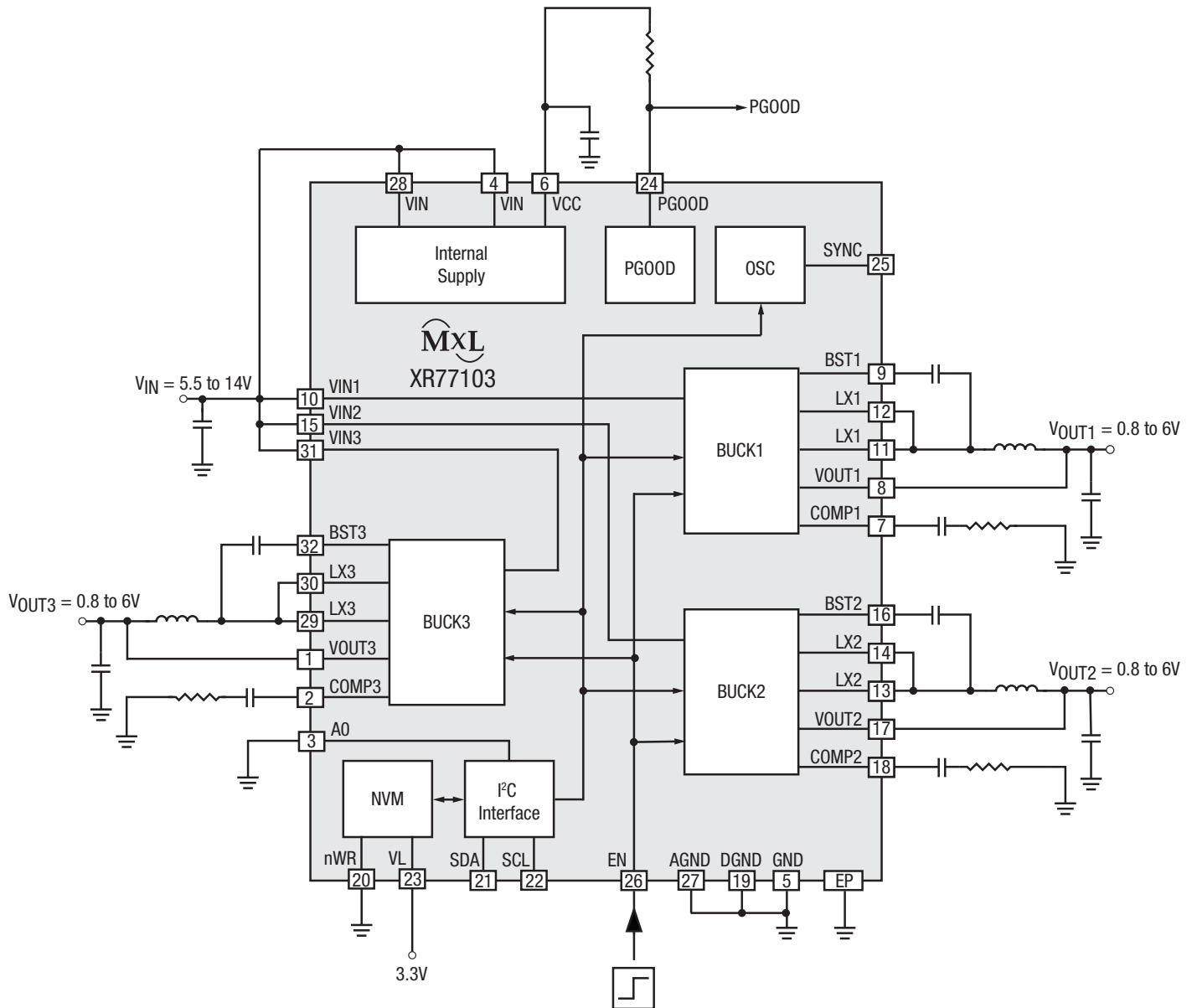

Figure 1. Typical Application

Absolute Maximum Ratings

These are stress ratings only and functional operation of the device at these ratings or any other above those indicated in the operation sections of the specifications below is not implied. Stresses beyond those listed under absolute maximum ratings may cause permanent damage to the device. Exposure to any absolute maximum rating condition for extended periods may affect device reliability and lifetime.

V_{IN1} , V_{IN2} , V_{IN3} , LX1, LX2, LX3.....	-0.3V to 18V
VL, EN, SCL, SDA, nWR, A0, V_{CC}	-0.3V to 7V
PGOOD, SYNC	-0.3V to 7V
BST# to LX#	-0.3V to 7V
AGND, DGND to GND.....	-0.3V to 0.3V
Storage temperature.....	-65°C to 150°C
Junction temperature.....	150°C
Power dissipation	Internally Limited
Lead temperature (soldering, 10 seconds).....	260°C
CDM	700V
ESD rating (HBM – human body model)	2kV

Operating Conditions

V_{IN}	4.5V to 14V
V_{CC}	4.5V to 5.5V
LX#	-0.3V to 14V ⁽¹⁾
Junction temperature range (T_J).....	-40°C to 125°C
XR77103 package power dissipation max at 25°C	3.4W
XR77103 thermal resistance θ_{JA}	30°C/W

NOTE:

1. LX# pins' DC range is from -0.3V, transient -1V for less than 10ns.

Electrical Characteristics

$T_A = 25^\circ\text{C}$, $V_{IN} = 12\text{V}$, $EN = V_{CC}$, $f_{SW} = 1\text{MHz}$, unless otherwise specified. Limits applying over the full operating temperature range are denoted by a •.

Symbol	Parameter	Conditions	•	Min	Typ	Max	Units
Power Supply Characteristics							
V_{IN}	Input voltage range		•	5.5		14	V
V_{IN}	Input voltage range	V_{CC} tied to V_{IN} for $V_{IN} = 5\text{V}$	•	4.5		5.5	V
V_{UVLO}	UVLO threshold	$UV = 0$, V_{IN} rising/falling			4.22/4.1		V
		$UV = 1$, V_{IN} rising/falling			7/6.88		
$UVLO_{DEGLITCH}$	UVLO deglitch	Rising/falling			110		μs
I_{VIN}	V_{IN} supply current	$EN = \text{GND}$			250		μA
I_{VINQ}		$EN = \text{high}$, no load, CCM			36		mA
I_{VINQ_LP}		$EN = \text{high}$, no load, PSM			2.6		mA
Internal Supply Voltage							
V_{CC}	Internal biasing supply	$I_{LOAD} = 0\text{mA}$	•	4.9	5	5.1	V
I_{VCC}	Internal biasing supply current	$V_{IN} = 12\text{V}$	•			10	mA
V_{UVLO}	UVLO threshold for V_{CC}	V_{CC} rising			3.8		V
		V_{CC} falling			3.6		V
$UVLO_{DEGLITCH}$	UVLO deglitch for V_{CC}	Falling edge			110		μs

Electrical Characteristics (Continued)

$T_A = 25^\circ\text{C}$, $V_{IN} = 12\text{V}$, $EN = V_{CC}$, $f_{SW} = 1\text{MHz}$, unless otherwise specified. Limits applying over the full operating temperature range are denoted by a •.

Symbol	Parameter	Conditions	•	Min	Typ	Max	Units
Protections							
T_{SD}	Thermal shutdown temperature	Temperature rising, Non-latch off. T_{SD} release threshold, temperature = $T_{SD} - HY_{TSD}$			160		$^\circ\text{C}$
HY_{TSD}	Thermal shutdown hysteresis				20		$^\circ\text{C}$
$T_{SD_DEGLITCH}$	Thermal shutdown deglitch				110		μs
V_{OVBUCK}	Threshold voltage for buck overvoltage	Output rising (HS FET will be forced off)			109		%
		Output falling (HS FET will be allowed to switch)			107		%
Buck Converter							
f_{SW}	Switching frequency	$I^2\text{C}$ control	•	0.3		2.2	MHz
V_{OUTx}	Output voltage range		•	0.8		6	V
	Output voltage resolution				0.05		V
	Adjustable soft-start period range		•	0.5		4	ms
I_{LIMx}	Peak inductor current limit range		•	1		4	A
I_{LIMx}	Peak inductor current limit accuracy	Peak inductor current limit set at 3A	•	25		25	%
R_{ON_HSx}	HS switch on-resistance	$V_{IN} = 12\text{V}$			200		$\text{m}\Omega$
R_{ON_LS1}	LS switch on-resistance of Buck1	$V_{IN} = 12\text{V}$			60		$\text{m}\Omega$
$R_{ON_LS2/3}$	LS switch on-resistance of Buck2/3	$V_{IN} = 12\text{V}$			80		$\text{m}\Omega$
I_O	Output current capability	Continuous loading			2 ⁽¹⁾		A
D_{MAX}	Maximum duty cycle				95		%
$t_{ON\ MIN}$	Minimum on time				120		ns
	Line regulation ($\Delta V_{OX}/\Delta V_{INX}$)	$V_{INX} = 5.5$ to 14V , $I_{OX} = 1\text{A}$			0.5		$\%V_O$
	Load regulation ($\Delta V_{OX}/\Delta I_{OX}$)	$I_O = 10$ to 90% , $I_O = \text{MAX}$			0.5		$\%V_O/A$
	Output voltage accuracy	$V_{IN} = 12\text{V}$	•	-1	Normal	1	%
		$5.5\text{V} \leq V_{IN} \leq 14\text{V}$	•	-2	Normal	2	
$SYNC_{RANGE}$	Synchronization range		•	$f_{SW} + 5\%$		2.31	MHz
$SYNC_{D_MIN}$	Synchronization signal minimum duty cycle		•	40			%
$SYNC_{D_MAX}$	Synchronization signal maximum duty cycle		•			60	%

NOTE:

1. Subject to thermal derating. Design must not exceed the package thermal rating.

Electrical Characteristics (Continued)

$T_A = 25^\circ\text{C}$, $V_{IN} = 12\text{V}$, $EN = V_{CC}$, $f_{SW} = 1\text{MHz}$, unless otherwise specified. Limits applying over the full operating temperature range are denoted by a •.

Symbol	Parameter	Conditions	•	Min	Typ	Max	Units
Power Good Reset Generator							
V_{UVBUCK}	Threshold voltage for buck under voltage	Output falling, (disabled after t_{ON_HICCUP})			85		%
		Output rising, (PG will be asserted)			90		
$t_{PG_DEGLITCH}$	Deglintch time	Rising and falling			11		ms
t_{ON_HICCUP}	Hiccup mode on time	$V_{UVBUCKX}$ asserted			12		ms
t_{OFF_HICCUP}	Hiccup mode off time	Once t_{OFF_HICCUP} elapses, all converters will start up again			15		ms
t_{RP}	Minimum reset period				1		s
R_{PG}	Power good pull-down on resistance				14	50	Ω
Input Threshold (SDA, SCL, nWR, A0)							
V_{IH}	Input threshold high	V_{INPUT} rising, $V_L = 3.3\text{V}$	•	1.52		1.83	V
V_{IL}	Input threshold low	V_{INPUT} falling, $V_L = 3.3\text{V}$	•	0.98		1.24	V
	A0, nWR pull up resistor				100		k Ω
Input Threshold (SYNC, EN)							
V_{IH}	Input threshold high	V_{INPUT} rising	•	2.07		2.53	V
V_{IL}	Input threshold low	V_{INPUT} falling	•	1.36		1.67	V

Electrical Characteristics (Continued)

$T_A = 25^\circ\text{C}$, $V_{IN} = 12\text{V}$, $EN = V_{CC}$, $f_{SW} = 1\text{MHz}$, unless otherwise specified. Limits applying over the full operating temperature range are denoted by a •.

Symbol	Parameter	Conditions	•	Min	Typ	Max	Units
I ² C Interface							
V_L	Supply voltage				3.3		V
V_{OL_I2C}	SDA logic output low voltage	At 3mA sink current	•			0.4	V
f_{SCL}	SCL clock frequency		•			400	kHz
t_{HIGH}	SCL clock high period		•	0.6			μs
t_{LOW}	SCL clock low period		•	1.3			μs
t_{SP}	I ² C spike rejection filter pulse width		•	0		50	ns
$t_{SU;DAT}$	I ² C data setup time		•	100			ns
$t_{HD;DAT}$	I ² C data hold time		•	0		900	ns
t_R	SDA, SCL rise time	$C_B = \text{total capacitance of bus line in pF}$	•		$20 + 0.1 \times C_B$	300	ns
t_F	SDA, SCL fall time	$C_B = \text{total capacitance of bus line in pF}$	•		$20 + 0.1 \times C_B$	300	ns
t_{BUF}	I ² C bus free time between stop and start		•	1.3			μs
$t_{SU;STA}$	I ² C repeated start condition setup time		•	0.6			μs
$t_{HD;STA}$	I ² C repeated start condition hold time		•	0.6			μs
$t_{SU;STO}$	I ² C stop condition setup time		•	0.6			μs
$t_{VD;DAT}$	I ² C data valid time		•			0.9	μs
$t_{VD;ACK}$	I ² C data valid acknowledge time		•			0.9	μs
C_B	I ² C bus capacitive load		•			400	pF
C_{SDA}	SDA input capacitance		•			10	pF
C_{SCL}	SCL input capacitance		•			10	pF

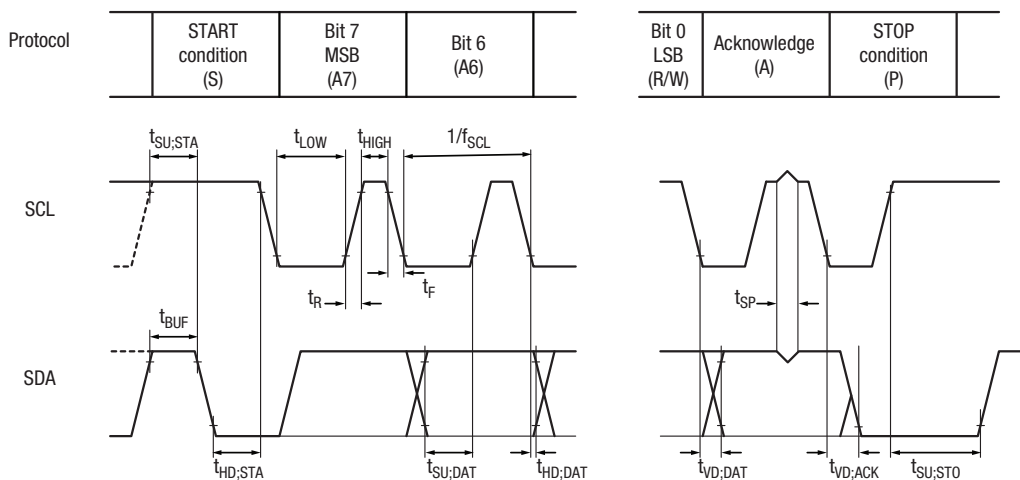
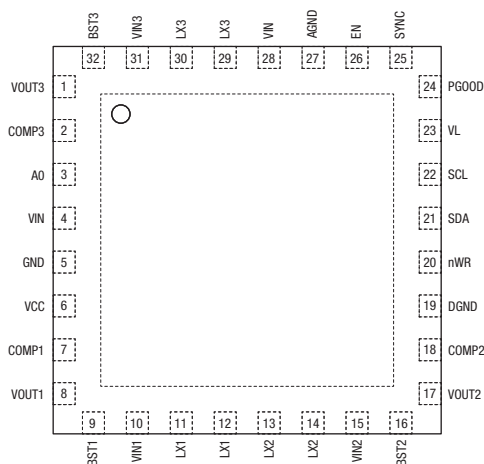

Figure 2. I²C Bus Timing Diagram

Pin Configuration



Pin Functions

Pin Number	Pin Name	Description
1	VOUT3	Buck 3 output sense pin.
2	COMP3	Compensation pin for Buck 3. Connect a series RC circuit to this pin for compensation.
3	A0	I ² C address select pin. A0 is internally pulled HIGH through a 100kΩ pull up resistor.
4	VIN ⁽¹⁾	IC supply pin. Connect a capacitor as close as possible to this pin and AGND.
5	GND	Ground.
6	VCC	Internal supply. Connect a ceramic capacitor from this pin to AGND. VCC tied to VIN for VIN = 5V
7	COMP1	Compensation pin for Buck 1. Connect a series RC circuit to this pin for compensation.
8	VOUT1	Buck 1 output sense pin.
9	BST1	Bootstrap capacitor for Buck 1. Connect a bootstrap capacitor from this pin to LX1.
10	VIN1 ⁽¹⁾	Input supply for Buck 1. Connect a capacitor as close as possible to this pin and PGND.
11	LX1	Switching node for Buck 1.
12	LX1	Switching node for Buck 1.
13	LX2	Switching node for Buck 2.
14	LX2	Switching node for Buck 2.
15	VIN2 ⁽¹⁾	Input supply for Buck 2. Connect a capacitor as close as possible to this pin and PGND.
16	BST2	Bootstrap capacitor for Buck 2. Connect a bootstrap capacitor from this pin to LX2.
17	VOUT2	Buck 2 output sense pin.
18	COMP2	Compensation pin for Buck 2. Connect a series RC circuit to this pin for compensation.
19	DGND	Digital ground.
20	nWR	Write protection input for NVM. The data can be written to NVM when this pin is low. This pin is internally pulled high through 100kΩ pull up resistance.

NOTE:

- VIN, VIN1, VIN2, and VIN3 must be tied together.

Pin Functions (Continued)

Pin Number	Pin Name	Description
21	SDA	Data I/O pin for I ² C serial interface.
22	SCL	Clock input pin for I ² C serial interface.
23	VL	Supply pin for I ² C interface. Supply 3.3V typically for I ² C communication. This pin can be left floating if the I ² C interface is not used.
24	PGOOD	Power good output. Open drain output asserted after all converters are sequenced and within regulation.
25	SYNC	External clock input pin. Connect to AGND when unused.
26	EN	Enable control input. Set EN high to enable converters.
27	AGND	Analog ground.
28	VIN ⁽¹⁾	IC supply pin. Connect a capacitor as close as possible to this pin and AGND.
29	LX3	Switching node for Buck 3.
30	LX3	Switching node for Buck 3.
31	VIN3 ⁽¹⁾	Input supply for Buck 3. Connect a capacitor as close as possible to this pin and PGND.
32	BST3	Bootstrap capacitor for Buck 3. Connect a bootstrap capacitor from this pin to LX3.
-	e-PAD	Power ground (PGND).

NOTE:

1. VIN, VIN1, VIN2, and VIN3 must be tied together.

Typical Performance Characteristics

All data taken at $T_A = 25^\circ\text{C}$ unless otherwise specified.

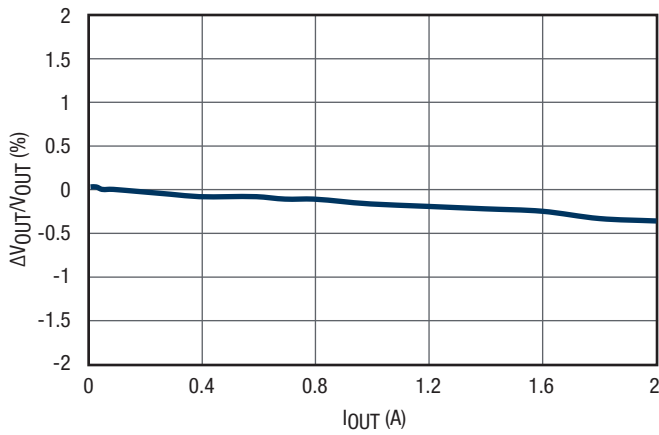

Figure 3. Load Regulation 12V_{IN} , 3.3V_{OUT} , $f_{\text{SW}} = 1\text{MHz}$

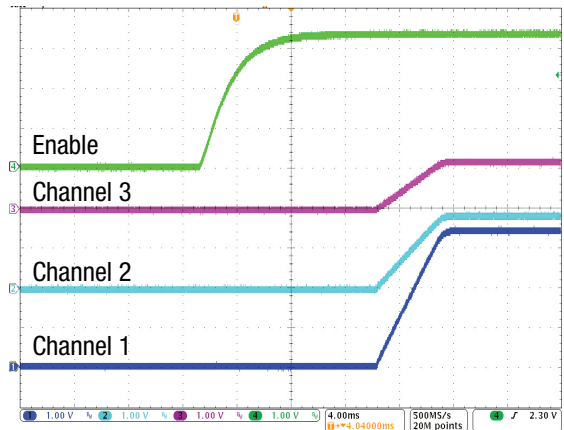

Figure 4. Power-up Sequence with Delay

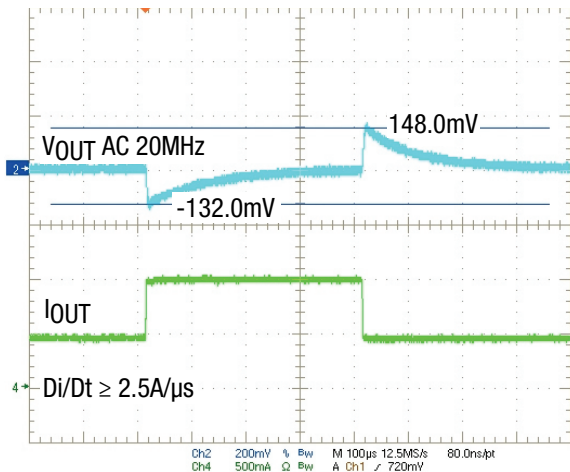

Figure 5. 12V_{IN} , 3.3V_{OUT} , $f_{\text{SW}} = 500\text{kHz}$
Transient Response, 0.5A to 1.0A

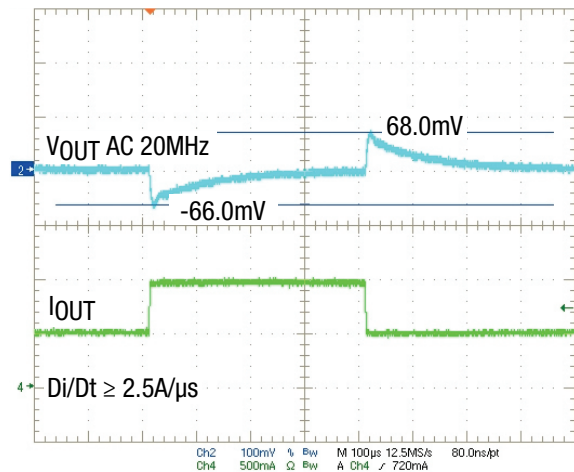

Figure 6. 5V_{IN} , 1.8V_{OUT} , $f_{\text{SW}} = 500\text{kHz}$
Transient Response, 0.5A to 1.0A

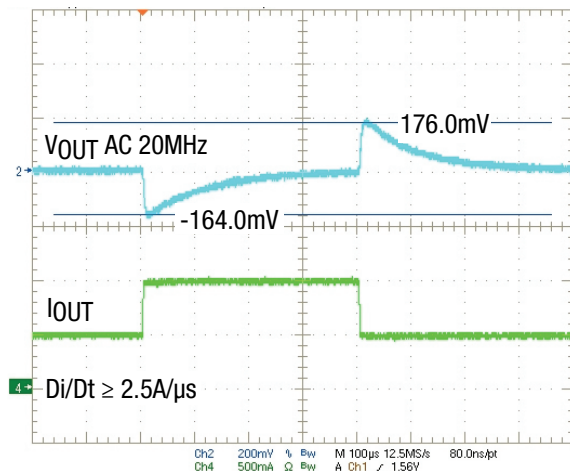

Figure 7. 12V_{IN} , 5.0V_{OUT} , $f_{\text{SW}} = 1\text{MHz}$
Transient Response, 0.5A to 1.0A

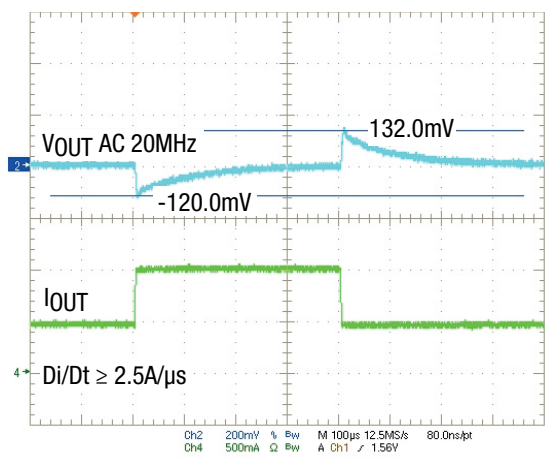

Figure 8. 5V_{IN} , 3.3V_{OUT} , $f_{\text{SW}} = 1\text{MHz}$
Transient Response, 0.5A to 1.0A

Typical Performance Characteristics (Continued)

Efficiency

$f_{SW} = 500\text{kHz}$, $T_A = 25^\circ\text{C}$, no airflow, only individual channel operating, inductor losses are included.

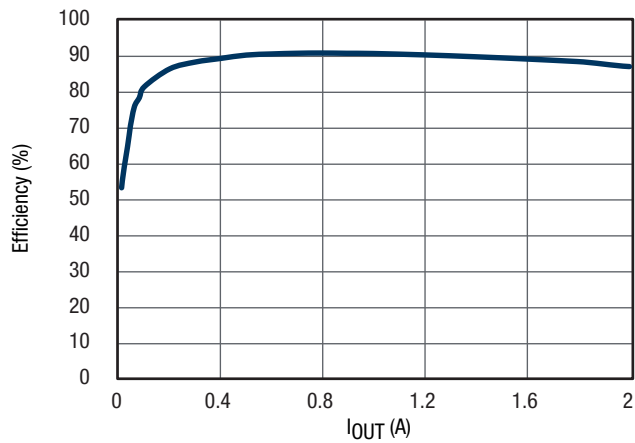

Figure 9. Efficiency Channel 1,
12V_{IN} 3.3V_{OUT}

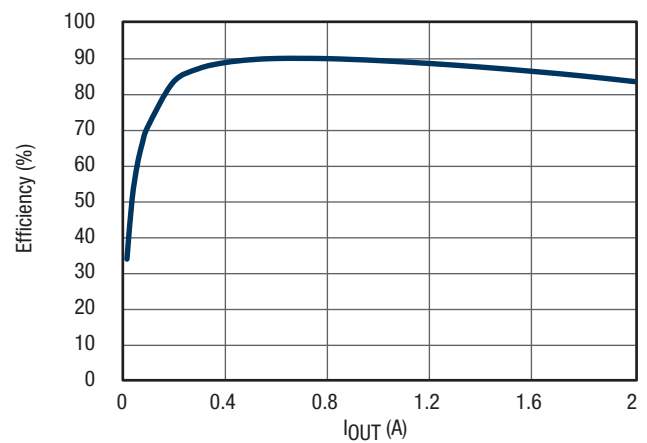

Figure 10. Efficiency Channel 1,
5V_{IN} 3.3V_{OUT}

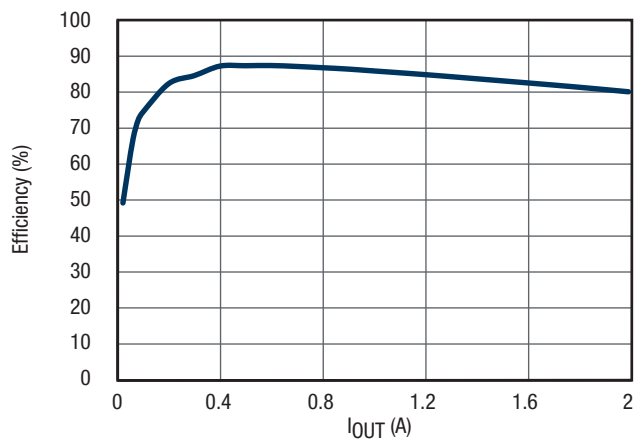

Figure 11. Efficiency Channel 2,
12V_{IN} 1.8V_{OUT}

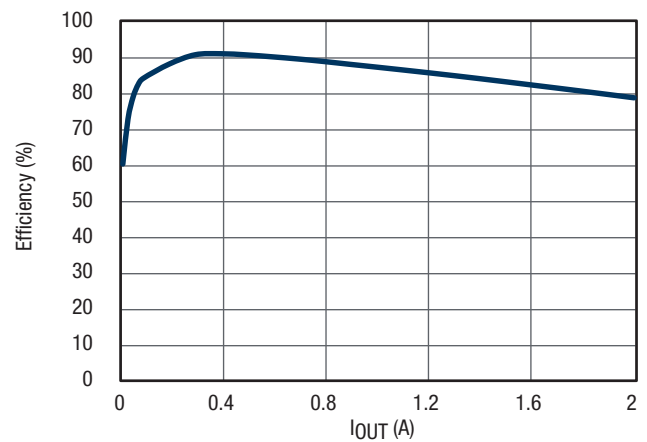

Figure 12. Efficiency Channel 2,
5V_{IN} 1.8V_{OUT}

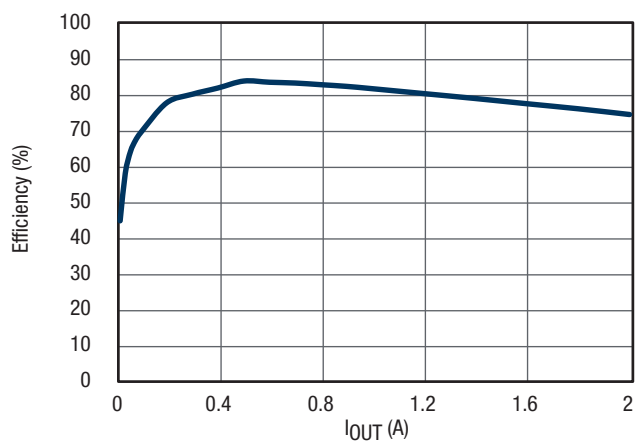

Figure 13. Efficiency Channel 3,
12V_{IN} 1.2V_{OUT}

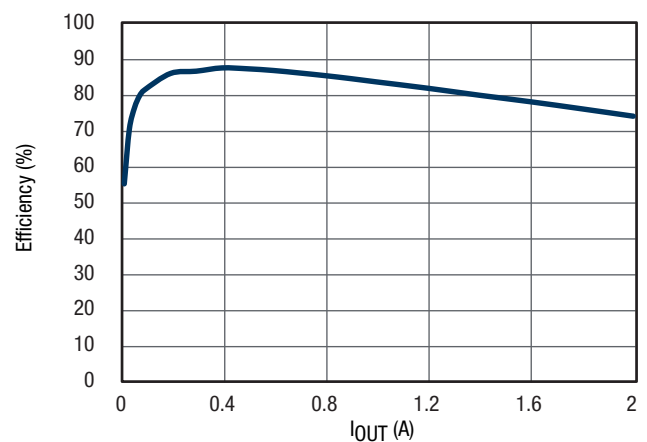

Figure 14. Efficiency Channel 3,
5V_{IN} 1.2V_{OUT}

Typical Performance Characteristics (Continued)

Efficiency

$f_{SW} = 1\text{MHz}$, $T_A = 25^\circ\text{C}$, no airflow, only individual channel operating, inductor losses are included.

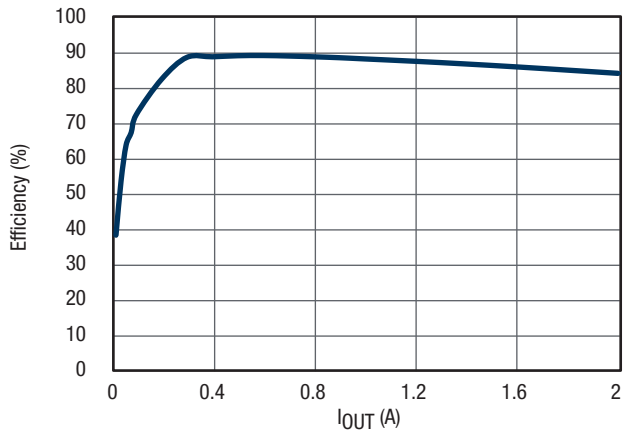

Figure 15. Efficiency Channel 1,
12VIN 3.3VOUT

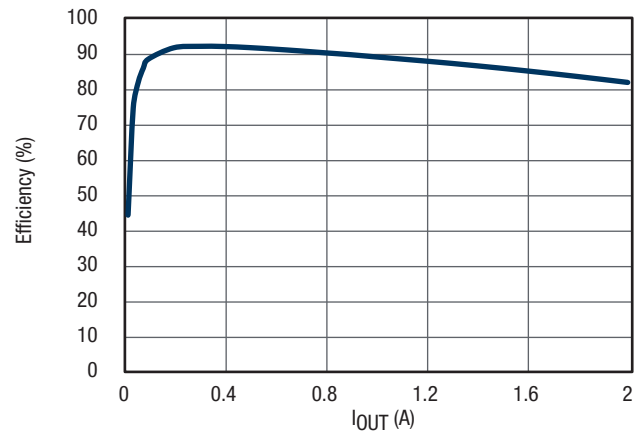

Figure 16. Efficiency Channel 1,
5VIN 3.3VOUT

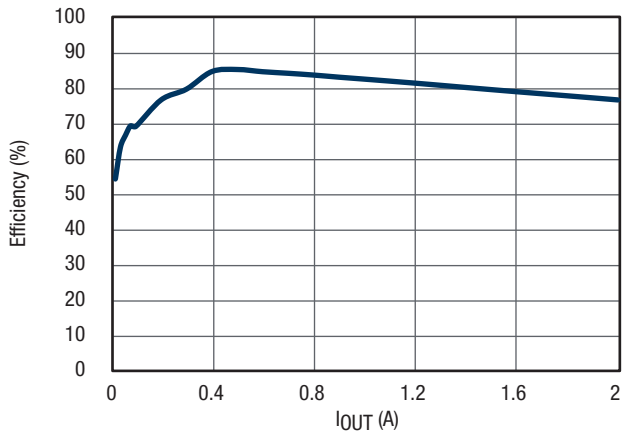

Figure 17. Efficiency Channel 2,
12VIN 1.8VOUT

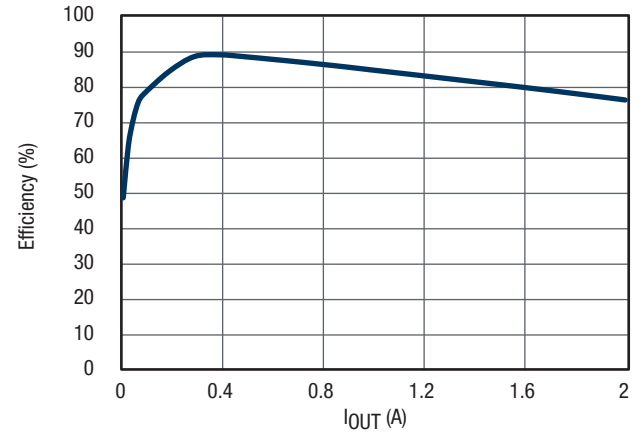

Figure 18. Efficiency Channel 2,
5VIN 1.8VOUT

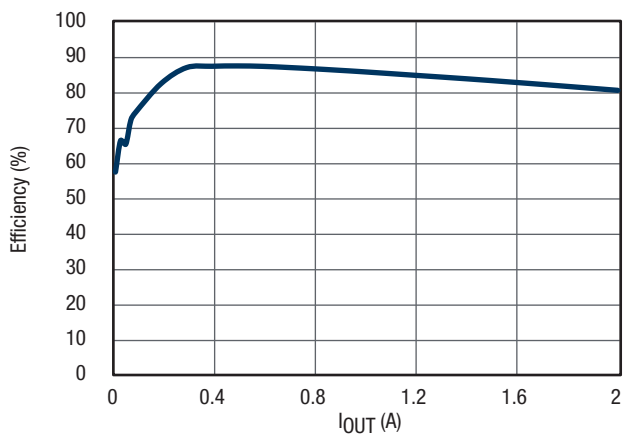

Figure 19. Efficiency Channel 3,
12VIN 2.5VOUT

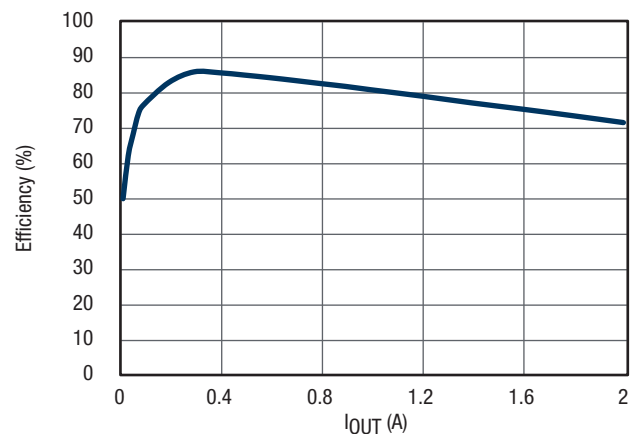

Figure 20. Efficiency Channel 3,
5VIN 1.2VOUT

Typical Performance Characteristics (Continued)

Thermal Characteristics

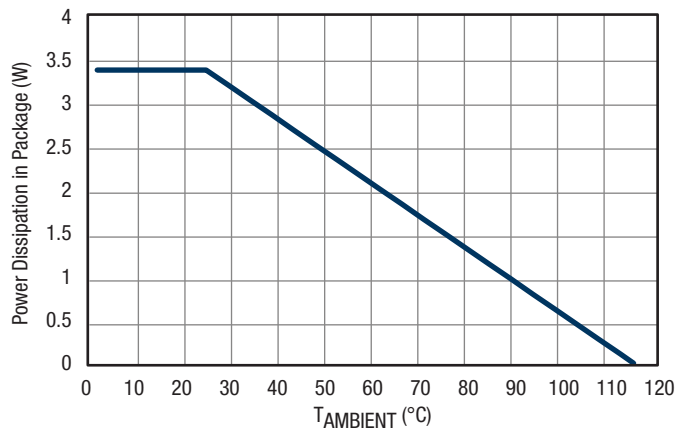

Figure 21. Package Thermal Derating

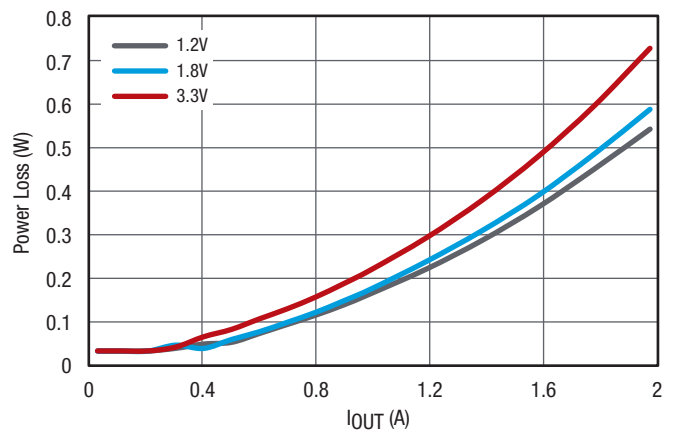

Figure 22. Channel 1 Power Loss at $f_{SW} = 500\text{kHz}$, $V_{IN} = 12\text{V}$, No Airflow

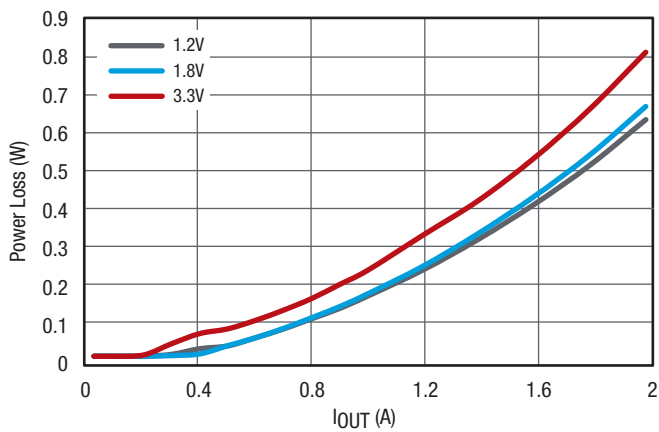

Figure 23. Channel 2 Power Loss at $f_{SW} = 500\text{kHz}$, $V_{IN} = 12\text{V}$, No Airflow

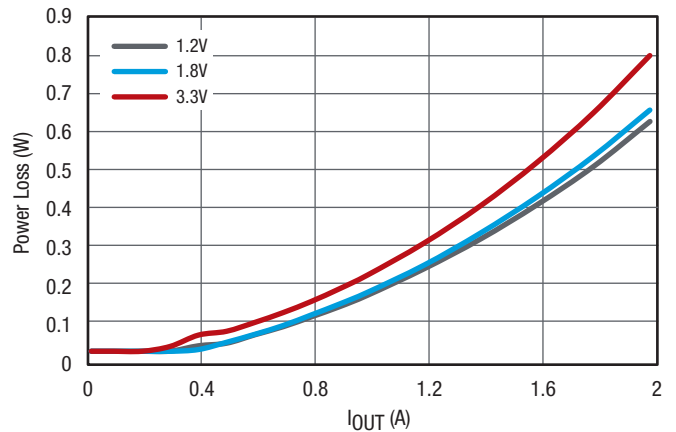

Figure 24. Channel 3 Power Loss at $f_{SW} = 500\text{kHz}$, $V_{IN} = 12\text{V}$, No Airflow

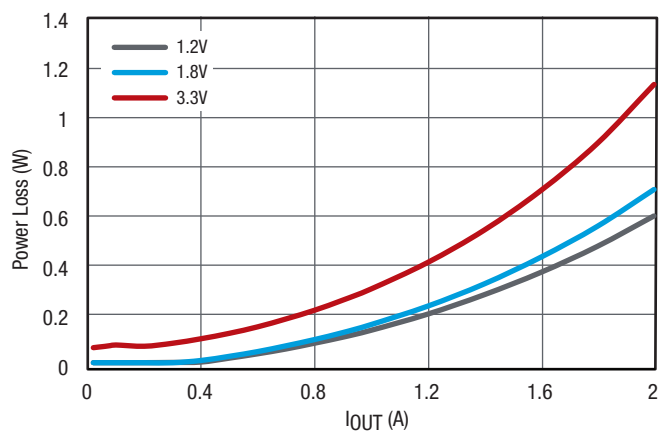

Figure 25. Channel 1 Power Loss at $f_{SW} = 500\text{kHz}$, $V_{IN} = 5\text{V}$, No Airflow

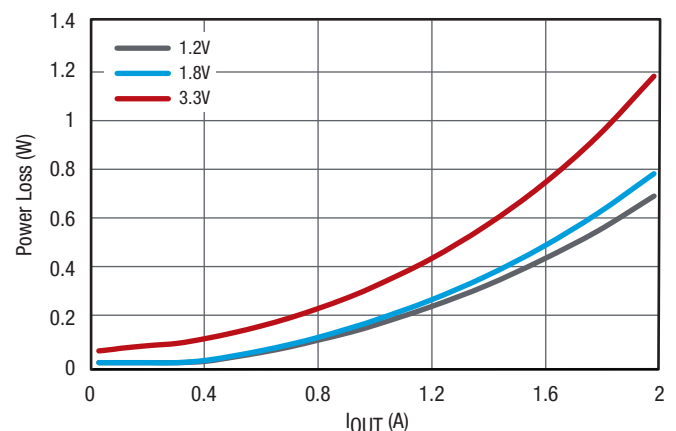

Figure 26. Channel 2 Power Loss at $f_{SW} = 500\text{kHz}$, $V_{IN} = 5\text{V}$, No Airflow

Typical Performance Characteristics (Continued)

Thermal Characteristics

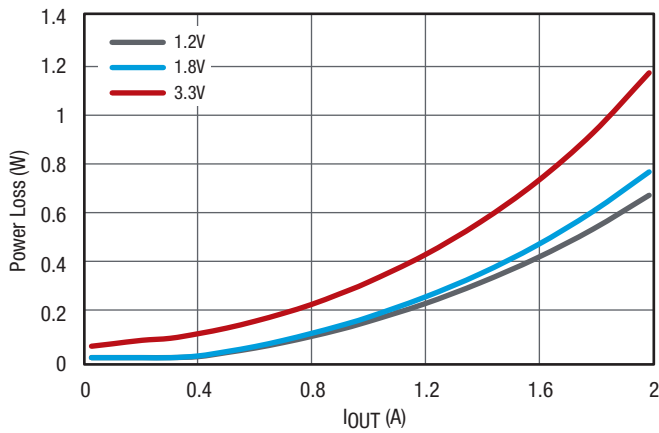

Figure 27. Channel 3 Power Loss at $f_{SW} = 500\text{kHz}$, $V_{IN} = 5\text{V}$, No Airflow

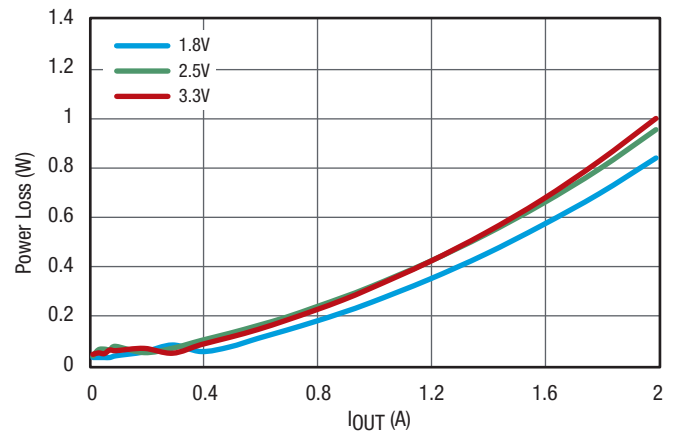

Figure 28. Channel 1 Power Loss at $f_{SW} = 1\text{MHz}$, $V_{IN} = 12\text{V}$, No Airflow

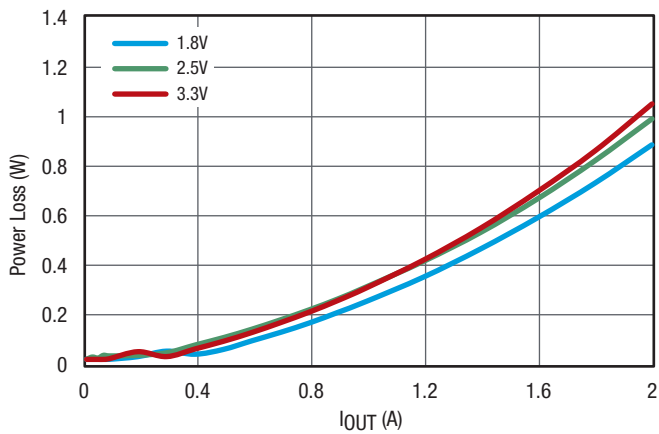

Figure 29. Channel 2 Power Loss at $f_{SW} = 1\text{MHz}$, $V_{IN} = 12\text{V}$, No Airflow

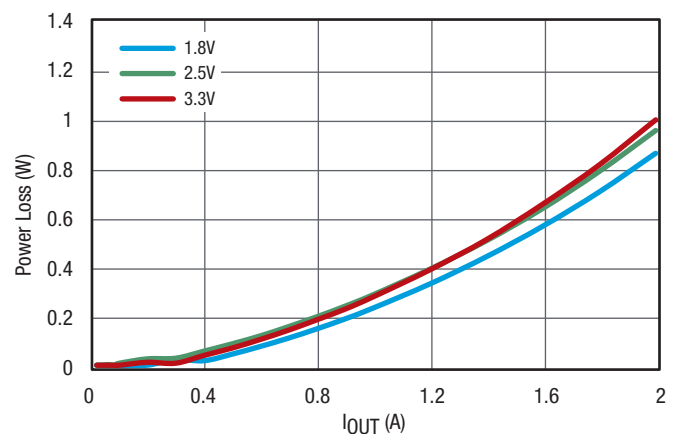

Figure 30. Channel 3 Power Loss at $f_{SW} = 1\text{MHz}$, $V_{IN} = 12\text{V}$, No Airflow

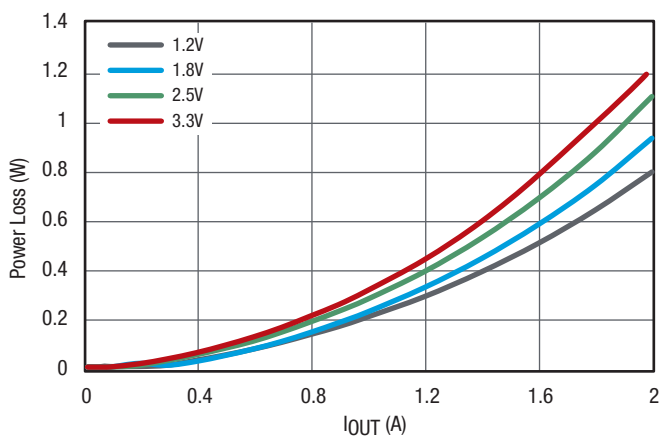

Figure 31. Channel 1 Power Loss at $f_{SW} = 1\text{MHz}$, $V_{IN} = 5\text{V}$, No Airflow

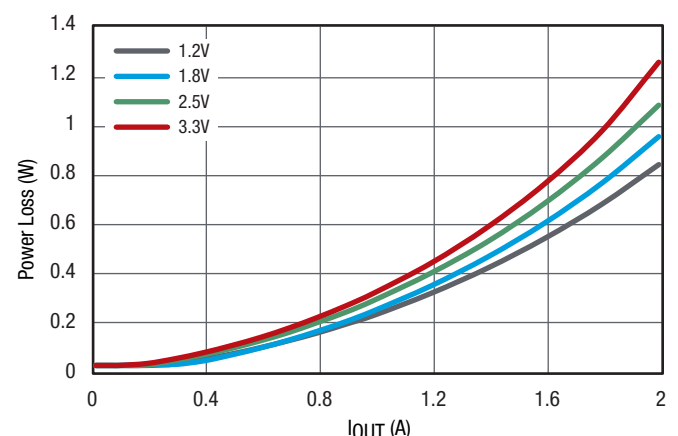

Figure 32. Channel 2 Power Loss at $f_{SW} = 1\text{MHz}$, $V_{IN} = 5\text{V}$, No Airflow

Typical Performance Characteristics (Continued)

Thermal Characteristics

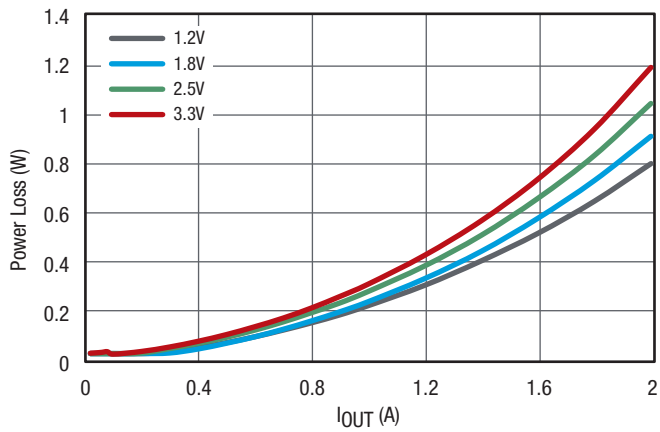

Figure 33. Channel 3 Power Loss at $f_{SW} = 1\text{MHz}$, $V_{IN} = 5\text{V}$, No Airflow

Functional Block Diagram

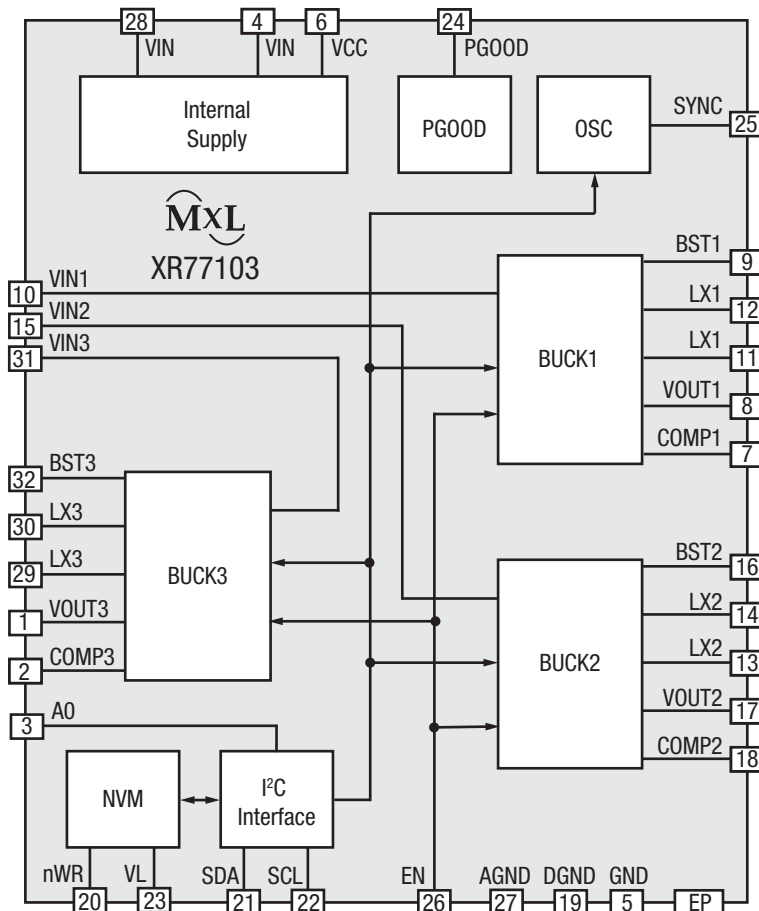

Figure 34. Functional Block Diagram

Applications Information

Operation

XR77103 is a power management IC with three step-down buck converters. Both high-side and low-side MOSFETs are integrated to provide fully synchronous conversion with higher efficiency. XR77103 can support 4.5V to 14V input supply, high load current, 300kHz to 2.2MHz clocking. The buck converters have an optional PSM mode which can improve power dissipation at light loads. Alternatively, the device implements a constant frequency mode. The wide switching frequency of 300kHz to 2.2MHz allows for efficiency and size optimization. The switching frequency is adjustable by writing data through I²C. The SYNC pin also provides means to synchronize the power converter to an external clock signal. Input ripple is reduced by 180 degree out-of-phase operation among converters. All three buck converters have peak current mode control which simplifies external frequency compensation. Each buck converter has an individual peak inductor current limit which is set through I²C. The adjustable current limit enables high efficiency design with smaller and less expensive inductors. The device has a power good comparator monitoring the output voltages. Each converter has its own soft-start independently controlled through I²C.

Continuous Conduction Mode (CCM)

This is a natural mode of a synchronous buck converter. Advantage of the CCM mode is that the switching frequency is always constant and allows for better EMI control in the system. The downside of CCM mode is that at light loads system efficiency will become lower.

Pulse Skipping Mode (PSM)

In order to improve efficiency at light load the device implements two functions. Both functions are enabled simultaneously. One function is a Zero Current Detect comparator (ZCD) which detects zero current in the inductor and turns off synchronous MOSFET, preventing negative inductor current. This ensures that the device enters DCM mode as the load decreases. In this mode the device still operates at a constant frequency. The second function is an internal skip comparator. This comparator detects low level of output current. If this low level is detected the device will start to skip pulses. This is done to improve light load efficiency by effectively reducing switching frequency. For details contact powertechsupport@exar.com.

Output Voltage Setting

Output voltage of each converter can be programmed by I²C interface. It can be set from 0.8V to 6V with 6-bit resolution. The registers 00h to 02h are allocated to setting each output of the converters. Alternatively, output voltages can be set externally using external resistor dividers. Setting EXT_x (bit 7) of the registers 00h to 02h allows external resistor divider for feedback. Output voltage is determined by the following equation.

$$V_{OX} = 0.8V \times \left(1 + \frac{R1}{R2}\right)$$

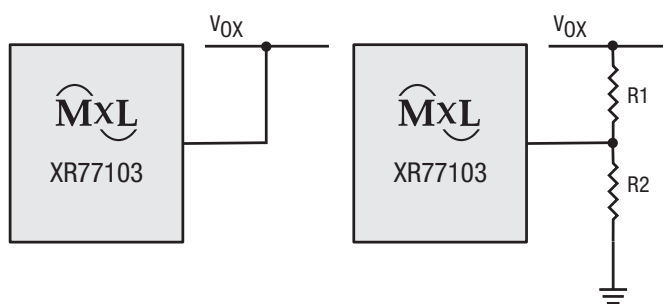

Figure 35. Output Voltage Setting

This feature can make the device applicable to AVS (automatic voltage scaling) system. Output voltage can be adjusted automatically by external DC voltage. Figure 36 shows application circuit of supply for AVS system.

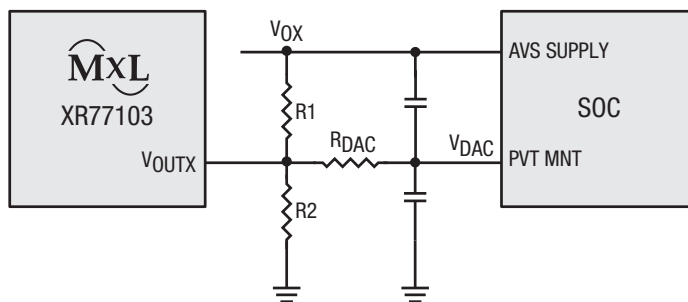

Figure 36. AVS Control

Applications Information (Continued)

Frequency Compensation

In order to properly frequency compensate the device, the following component selection is recommended. The table below is for 2A loads.

V_{IN} (V)	V_{OUT} (V)	L (μ H)	C_{OUT} (μ F)	R_{COMP} (k Ω)	C_{COMP} (nF)
500kHz Switching Frequency					
12/5.0	1.0	2.2	22 x 3	10	4.7
12/5.0	1.2	2.2	22 x 3	10	4.7
12/5.0	1.5	3.3	22 x 3	20	4.7
12/5.0	1.8	3.3	22 x 2	20	4.7
12/5.0	2.5	4.7	22 x 2	20	4.7
12/5.0	3.3	4.7	22 x 1	20	4.7
12	5.0	6.8	22 x 1	20	4.7
1MHz Switching Frequency					
5.0	1.0	1.5	22 x 3	10	4.7
5.0	1.2	1.5	22 x 3	10	4.7
5.0	1.5	1.5	22 x 2	20	4.7
12/5.0	1.8	1.5	22 x 2	20	4.7
12/5.0	2.5	3.3	22 x 1	20	4.7
12/5.0	3.3	3.3	22 x 1	20	4.7
12	5.0	3.3	22 x 1	20	4.7

For configurations not listed above contact powertechsupport@exar.com.

Switching Frequency Setting

Switching frequency can be set from 300kHz to 2.2MHz with a 100kHz step. Lower 5 bits of the register 09h are allocated to setting the switching frequency.

Current Limit Setting

Peak inductor current limit level of each converter can be set individually from 1A to 4A with a 0.5A step. Lower 3 bits of the registers 06h, 07h and 08h are allocated to setting the peak inductor current limit of Buck 1, Buck 2 and Buck 3 respectively.

Soft-start Time Setting

Soft-start time of each converter can be set individually (see Figure 36). Lower 3 bits of the registers 03h, 04h and 05h are allocated to setting the soft-start time of Buck 1, Buck 2 and Buck 3 respectively.

The soft-start times are relative to switching frequency. They scale with switching frequency.

At switching frequency set at 1MHz, the available soft-start range is from 0.5ms to 4ms with a 0.5ms step.

At switching frequency set at 500kHz, the available soft-start range is from 1ms to 8ms with a 1ms step.

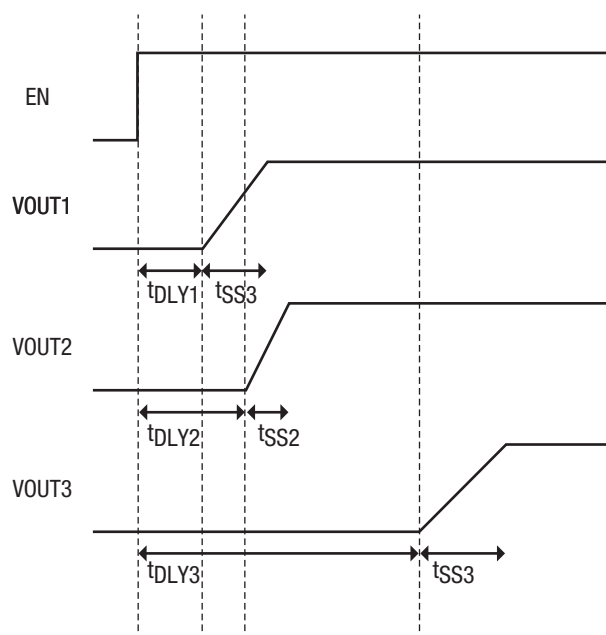

Figure 37. Programmable Soft-start Time and Delay Time of each Converter

Delayed Start-Up

All outputs start up once EN pin is high and select bits of each converter are set. If a delayed start-up is required on any of the buck converters, set delay time of each converter. The bits [6:4] of the registers 03h, 04h and 05h are allocated to setting delay time of Buck 1, Buck 2 and Buck 3 respectively.

The soft-start delay times are relative to switching frequency. They scale with switching frequency.

At switching frequency set at 1MHz, the available soft-start delay time range is from 0ms to 35ms with a 5ms step.

At switching frequency set at 500kHz, the available soft-start delay time range is from 0ms to 70ms with a 10ms step.

Applications Information (Continued)

Synchronization

The status of the SYNC pin will be ignored during start-up and the XR77103's control will only synchronize to an external signal after the PGOOD signal is asserted. When synchronization is applied, the PWM oscillator frequency must be lower than the sync pulse frequency to allow the external signal trumping the oscillator pulse reliably. When synchronization is not applied, the SYNC pin should be connected to AGND.

Although the device can lock to external clock running up to 2.31MHz, doing this will alter the start-up times, start-up delays and PGOOD delays, and there will be higher losses than what is shown in Figures 22-33. For details contact powertechsupport@exar.com.

Out-of-Phase Operation

All converters operate in phase, or one converter operates 180 degrees out-of-phase with the other two converters (see Figure 38). The phase shift among the converter is programmable. The bits 6, 5 of the register 09h are allocated for this feature. This enables the system, having less input ripple, to lower component cost, save board space and reduce EMI.

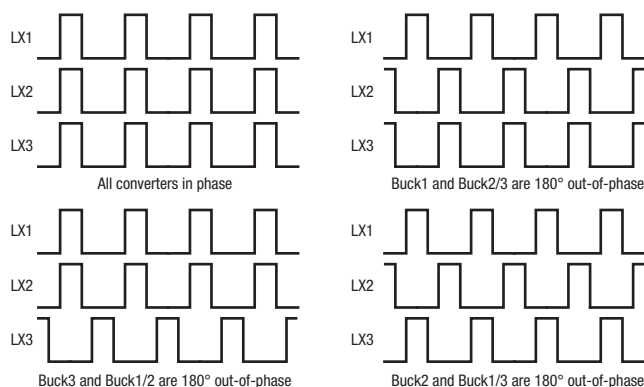

Figure 38. Out-of-Phase Operation

Two Buck Regulators in Parallel Operation (Current Sharing)

The XR77103 can be used in parallel operation to increase output current capacity. Figure 39 shows one of possible configurations. To enable this a user needs:

Hardware Configuration

- To connect both V_{OUTx} together.
- To connect both C_{OMPx} together.

Software Configuration

- To set 180 out-of-phase operation between buck regulators (register 09h).
- Programming both V_{OUTx} to the same output.

Then, two out of three bucks will run in parallel and load current is shared in average.

The ideal case is to use Buck 2 and Buck 3 in parallel operation since they are both identical in design.

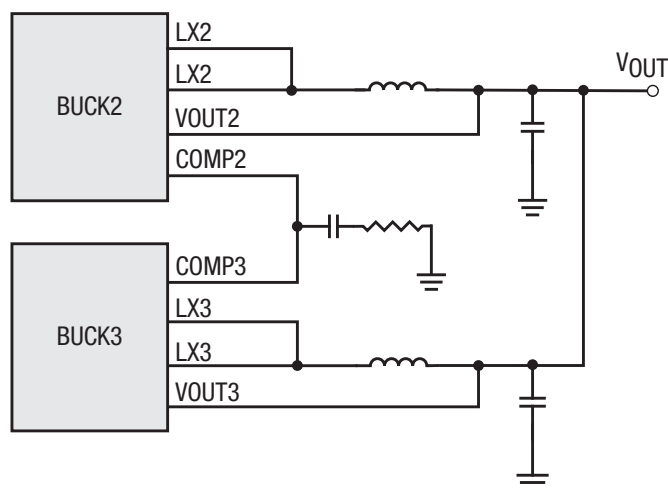

Figure 39. Parallel Operation

Applications Information (Continued)

Power Good

The PGOOD pin is an open drain output. The PGOOD pin is pulled low when any buck converter is pulled below 85% of the nominal output voltage. The PGOOD is pulled up when selected buck converters' outputs are more than 90% of their nominal output voltage and the PGOOD reset timer expires. The polarity of the PGOOD is active high. The PGOOD reset time is determined by following equation. Figure 40 shows the relationship between switching frequency and the PGOOD reset time. For example, when the switching frequency is 1MHz, the PGOOD reset time is 1s.

$$t_{RP} = \frac{1}{f_{SW}} \times 10^6$$

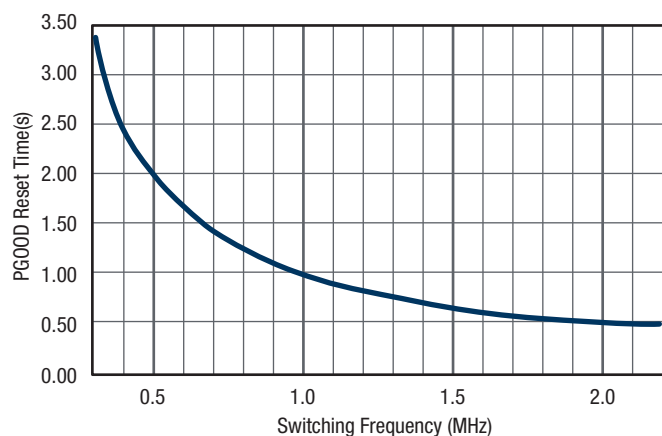

Figure 40. PGOOD Reset Time vs. f_{sw}

Selectable UVLO Threshold

The threshold for UVLO is selectable (7V/4.2V). When input voltage is higher, 9V and 12V for example, both settings can be used. However, when the input voltage is 5V, the UVLO setting must be 4.2V.

Supply Voltage for Data Programming and Writing to NVM

V_L is the supply voltage for I²C interface and is required for all I²C transactions. The V_L pin can be left floating if the I²C interface is not used.

To write data to NVM, V_{IN} must be 8V or higher.

The state of the nWR pin determines where the data gets written to. If the nWR pin is pulled low to ground, the data is written to the NVM. The I²C write transaction can start immediately after the nWR pin has been pulled low. A 100ms delay shall be added in between consecutive I²C writes to the NVM. After each byte is written to NVM location, the data gets automatically transferred to the run time equivalent register. If the nWR pin is pulled high or left floating, the data gets written to run time registers.

In case V_{IN} is below 8V, writing to NVM is not possible in which case the nWR pin must be pulled high or left floating to assure reliable writing to run time registers.

V_L	V_{IN}	EN	nWR	I ² C Write Behavior
3.3V	$\geq 8V$	LOW	LOW	Write to NVM, values loaded to run-time registers
3.3V	$\geq 8V$	HIGH	LOW	Not supported
3.3V	$\leq 8V$	X	LOW	Write has no effect
3.3V	4.5V to 14V	LOW	HIGH	Write to run-time registers with offsets > 02h
3.3V	4.5V to 14V	HIGH	HIGH	Not supported
3.3V	4.5V to 14V	X	HIGH	Write to run-time registers with offsets \leq 02h

In addition, the nWR pin state determines where data gets read from in case a read I²C command is transmitted on the bus. When initiating read transaction while the nWR pin is pulled high or left floating, the data is read from the run time registers. Reading run time registers can be done at any time.

On the other hand if the nWR pin is pulled low at the time when a read transaction is sent, the data is read from NVM. It is recommended not to permanently pull the nWR pin low. In designs where the nWR pin is pulled low permanently, the host shall not initiate read transaction while channels are enabled. Failing to do so will cause regulation interruption. Reading in this scenario shall be done while EN is low and channels are shut down.

V_L	V_{IN}	EN	nWR	I ² C Read Behavior
3.3V	4.5V to 14V	LOW	LOW	Read from NVM (when all channels are disabled)
3.3V	4.5V to 14V	HIGH	LOW	Not supported
3.3V	4.5V to 14V	X	HIGH	Read from run-time registers

At power-on, the run-time registers are loaded with their default values from the NVM. This process takes approximately 200 μ s. No I²C operation should be performed during this time.

Applications Information (Continued)

Thermal Design

Proper thermal design is critical in controlling device temperatures and in achieving robust designs. There are a number of factors that affect the thermal performance. One key factor is the temperature rise of the devices in the package, which is a function of the thermal resistances of the devices inside the package and the power being dissipated.

The thermal resistance of the XR77103 (30°C/W) is specified in the Operating Conditions section of this datasheet. The θ_{JA} thermal resistance specification is based on the XR77103 evaluation board operating without forced airflow. Since the actual board design in the final application will be different, the thermal resistances in the final design may be different from those specified.

The package thermal derating and power loss curves are shown in Figures 21 through 33. These correspond to input voltages of 12V and 5V, and 500kHz and 1MHz switching frequencies.

Layout Guidelines

Proper PCB layout is crucial in order to obtain a good thermal and electrical performance.

For thermal considerations it is essential to use a number of thermal vias to connect the central thermal pad to the ground layer(s).

In order to achieve good electrical and noise performance following steps are recommended:

- Place the output inductor close to the LX pins and minimize the area of the connection. Doing this on the same layer is advisable.
- Central thermal pad, PGND, shall be connected as many layers as possible for good thermal performance. The input capacitors connected between VIN1, VIN2, VIN3 and PGND represent an AC current loop which should be minimized. PGND should connect to the system ground with vias placed at the output filtering capacitors.
- The AC current loop created by the output inductors, output filtering capacitors, and the regulator pins should also be minimized. However this loop is less critical than the input capacitors.
- GND, AGND, DGND can all be connected at the device and be connected to system ground at the output capacitor.
- Compensation networks shall be placed close to the pins and referenced to AGND.
- VCC bypass capacitor shall be placed close to the pin and connected to AGND.

I²C Bus Interface

The XR77103 features an I²C compatible, 2-wire serial interface consisting of a serial-data line (SDA) and a serial clock line (SCL). SDA and SCL facilitate communication between the IC and the master device at clock rates up to 400kHz. The I²C interface follows all standard I²C protocols. Some information is provided below. For additional information, refer to the I²C-bus specifications.

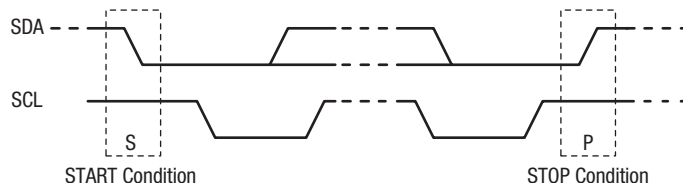

Figure 41. I²C Start and Stop Conditions

Start Condition

The master initiates data transfer by generating a start condition. The start condition is when a high-to-low transition occurs on the SDA line while SCL is high, as shown in Figure 41.

Slave Address Cycle

After the start condition, the first byte sent by the master is the 7-bit address and the read/write direction bit R/W on the SDA line. If the address matches the XR77103's internal fixed I²C slave address, the XR77103 will respond with an acknowledge by pulling the SDA line low for one clock cycle while SCL is high.

Data Cycle

After the master detects this acknowledge, the next byte transmitted by the master is the sub-address. This 8-bit sub-address contains the address of the register to access. The XR77103 Register Map is on page 20.

Applications Information (Continued)

Stop Condition

To signal the end of the data transfer, the master generates a stop condition by pulling the SDA line from low to high while the SCL line is high, as shown in Figure 41.

Figures 42 and 43 illustrate a write and a read cycle. For complete details, see the I²C-bus specifications.

S	SLAVE ADDRESS	W	A	REGISTER ADDRESS	A	DATA	A	P
---	---------------	---	---	------------------	---	------	---	---

NOTES:

White Block = host to XR77103, Orange Block = XR77103 to host.

Figure 42. Master Writes to Slave

S	SLAVE ADDRESS	W	A	REGISTER ADDRESS	A	S	SLAVE ADDRESS	R	A	DATA	NA	P
---	---------------	---	---	------------------	---	---	---------------	---	---	------	----	---

NOTES:

White Block = host to XR77103, Orange Block = XR77103 to host.

Figure 43. Master Reads from Slave

Slave Address

The slave address is one byte of data which is used as the unique identifier. The first 7 bits of the slave address are hard-coded and the least significant bit (LSB) of the slave address byte is the read/write (R/W) bit which is used to determine whether a command is a write command or a read command. The slave address is the first byte of information sent to the device after the START condition. Table below shows the possible slave addresses for the XR77103.

Device	Address (A0 = Low)	Address (A0 = High)
XR77103	0x74	0x75

Bit 7	Bit 6	Bit 5	Bit 4	Bit 3	Bit 2	Bit 1	Bit 0
1	1	1	0	1	0	A0	R/W

Register Map

Register Address	Register Name	Bit 7	Bit 6	Bit 5	Bit 4	Bit 3	Bit 2	Bit 1	Bit 0	Factory Default NVM Value
00h	V _{BUCK1}	EXT1	V _{BUCK1} [6:0] V _{BUCK2} [6:0] V _{BUCK3} [6:0]							00h
01h	V _{BUCK2}	EXT2								
02h	V _{BUCK3}	EXT3								
03h	Soft-start and Delay 1	-	DLY1 [2:0]			-	SST1 [2:0]			15h
04h	Soft-start and Delay 2	-	DLY2 [2:0]			-	SST2 [2:0]			
05h	Soft-start and Delay 3	-	DLY3 [2:0]			-	SST3 [2:0]			
06h	Current Limit 1	-	-	-	-	-	LIM1 [2:0]			05h
07h	Current Limit 2	-	-	-	-	-	LIM2 [2:0]			
08h	Current Limit 3	-	-	-	-	-	LIM3 [2:0]			
09h	Switching Frequency and Phase	-	PHS [1:0]	-	FRQ [4:0]	-	-	-	-	42h
0Ah	PWR	-	UV	-	-	PSM	Buck3	Buck2	Buck1	7Fh

Applications Information (Continued)

V_{BUCK1} Register (00h)

The V_{BUCK1} register has 7 bits of data for setting output of Buck 1 and 1 bit of data for use of external feedback voltage through a resistor divider. The Buck 1 programmable voltage range is from 0.8V to 6V with 0.05V resolution. When EXT1 is set to 1, the output voltage is adjusted by the external resistor divider from the output to ground with the center tap connected to V_{OUT1} pin regardless of the value of the output voltage setting register. The factory default NVM value is 00h (0.8V).

Bit 7	Bit 6	Bit 5	Bit 4	Bit 3	Bit 2	Bit 1	Bit 0
EXT1	D6	D5	D4	D3	D2	D1	D0

Hex	V _{OUT} (V)
00	0.8
01	0.85
02	0.9
03	0.95
04	1
05	1.05
06	1.1
07	1.15
08	1.2
09	1.25
0A	1.3
0B	1.35
0C	1.4
0D	1.45
0E	1.5
10	1.6
11	1.65
12	1.7
13	1.75
14	1.8
15	1.85
16	1.9
17	1.95
18	2
19	2.05

Hex	V _{OUT} (V)
1A	2.1
1B	2.15
1C	2.2
1D	2.25
1E	2.3
20	2.4
21	2.45
22	2.5
23	2.55
24	2.6
25	2.65
26	2.7
27	2.75
28	2.8
29	2.85
2A	2.9
2B	2.95
2C	3
2D	3.05
2E	3.1
30	3.2
31	3.25
32	3.3
33	3.35
34	3.4

Hex	V _{OUT} (V)
35	3.45
36	3.5
37	3.55
38	3.6
39	3.65
3A	3.7
3B	3.75
3C	3.8
3D	3.85
3E	3.9
40	4
41	4.05
42	4.1
43	4.15
44	4.2
45	4.25
46	4.3
47	4.35
48	4.4
49	4.45
4A	4.5
4B	4.55
4C	4.6
4D	4.65
4E	4.7

Hex	V _{OUT} (V)
50	4.8
51	4.85
52	4.9
53	4.95
54	5
55	5.05
56	5.1
57	5.15
58	5.2
59	5.25
5A	5.3
5B	5.35
5C	5.4
5D	5.45
5E	5.5
60	5.6
61	5.65
62	5.7
63	5.75
64	5.8
65	5.85
66	5.9
67	5.95
68	6

Applications Information (Continued)

V_{BUCK2} Register (01h)

The V_{BUCK2} register has 7 bits of data for setting output of Buck 2 and 1 bit of data for use of external feedback voltage through a resistor divider. The Buck 2 programmable voltage range is from 0.8V to 6V with 0.05V resolution. When EXT2 is set to 1, the output voltage is adjusted by the external resistor divider from the output to ground with the center tap connected to V_{OUT2} pin regardless of the value of the output voltage setting register. The factory default NVM value is 00h (0.8V).

Bit 7	Bit 6	Bit 5	Bit 4	Bit 3	Bit 2	Bit 1	Bit 0
EXT2	D6	D5	D4	D3	D2	D1	D0

V_{BUCK3} Register (02h)

The V_{BUCK3} register has 7 bits of data for setting output of Buck 3 and 1 bit of data for use of external feedback voltage through a resistor divider. The Buck 3 programmable voltage range is from 0.8V to 6V with 0.05V resolution. When EXT3 is set to 1, the output voltage is adjusted by the external resistor divider from the output to ground with the center tap connected to V_{OUT3} pin regardless of the value of the output voltage setting register. The factory default NVM value is 00h (0.8V).

Bit 7	Bit 6	Bit 5	Bit 4	Bit 3	Bit 2	Bit 1	Bit 0
EXT3	D6	D5	D4	D3	D2	D1	D0

SST1 and DLY1 Register (03h)

Soft-start time 1 and delay time 1 register has 6 effective bits. Three bits are for setting soft-start time of Buck 1 and three bits are for setting delay time from EN to Buck 1 start-up. The factory default soft-start and delay times are 6ms and 10ms respectively at 500kHz switching frequency. Both soft-start and delay times are relative to the switching frequency. They will be two times smaller at 1MHz switching frequency.

Bit 7	Bit 6	Bit 5	Bit 4	Bit 3	Bit 2	Bit 1	Bit 0
X	D6	D5	D4	X	D2	D1	D0

D2	D1	D0	t _{SS} (ms) at f _{SW} = 500kHz	t _{SS} (ms) at f _{SW} = 1MHz
0	0	0	1	0.5
0	0	1	2	1
0	1	0	3	1.5
0	1	1	4	2
1	0	0	5	2.5
1	0	1	6	3
1	1	0	7	3.5
1	1	1	8	4

D6	D5	D4	t _{DLY} (ms) at f _{SW} = 500kHz	t _{DLY} (ms) at f _{SW} = 1MHz
0	0	0	0	0
0	0	1	10	5
0	1	0	20	10
0	1	1	30	15
1	0	0	40	20
1	0	1	50	25
1	1	0	60	30
1	1	1	70	35

Applications Information (Continued)

SST2 and DLY2 Register (04h)

Soft-start time 2 and delay time 2 register has 6 effective bits. Three bits are for setting soft-start time of Buck 2 and three bits are for setting delay time from EN to Buck 2 start-up. The factory default soft-start and delay times are 6ms and 10ms respectively at 500kHz switching frequency. Both soft-start and delay times are relative to the switching frequency. They will be two times smaller at 1MHz switching frequency.

Bit 7	Bit 6	Bit 5	Bit 4	Bit 3	Bit 2	Bit 1	Bit 0
X	D6	D5	D4	X	D2	D1	D0

SST3 and DLY3 Register (05h)

Soft-start time 3 and delay time 3 register has 6 effective bits. Three bits are for setting soft-start time of Buck 3 and three bits are for setting delay time from EN to Buck 3 start-up. The factory default soft-start and delay times are 6ms and 10ms respectively at 500kHz switching frequency. Both soft-start and delay times are relative to the switching frequency. They will be two times smaller at 1MHz switching frequency.

Bit 7	Bit 6	Bit 5	Bit 4	Bit 3	Bit 2	Bit 1	Bit 0
X	D6	D5	D4	X	D2	D1	D0

Current Limit 1 Register (06h)

Current limit 1 register has 3 effective bits. The factory default value is 3.5A (05h).

Bit 7	Bit 6	Bit 5	Bit 4	Bit 3	Bit 2	Bit 1	Bit 0
X	X	X	X	X	D2	D1	D0

D2	D1	D0	$I_{LIM1}(A)$
0	0	0	1
0	0	1	1.5
0	1	0	2
0	1	1	2.5
1	0	0	3
1	0	1	3.5
1	1	0	4

Current Limit 2 Register (07h)

Current limit 2 register has 3 effective bits. The factory default value is 3.5A (05h).

Bit 7	Bit 6	Bit 5	Bit 4	Bit 3	Bit 2	Bit 1	Bit 0
X	X	X	X	X	D2	D1	D0

Current Limit 3 Register (08h)

Current limit 3 register has 3 effective bits. The factory default value is 3.5A (05h).

Bit 7	Bit 6	Bit 5	Bit 4	Bit 3	Bit 2	Bit 1	Bit 0
X	X	X	X	X	D2	D1	D0

Applications Information (Continued)

Switching Frequency and Phase Register (09h)

Switching frequency and phase register has 7 effective bits. The 5 least significant bits are setting switching frequency. The factory default value is 500kHz (00010b).

Bit 7	Bit 6	Bit 5	Bit 4	Bit 3	Bit 2	Bit 1	Bit 0
X	D6	D5	D4	D3	D2	D1	D0

D [4:0] Hex	f _{SW} [MHz]
00	0.3
01	0.4
02	0.5
03	0.6
04	0.7
05	0.8
06	0.9
07	1
08	1.1
09	1.2

D [4:0] Hex	f _{SW} [MHz]
0A	1.3
0B	1.4
0C	1.5
0D	1.6
0E	1.7
0F	1.8
10	1.9
11	2
12	2.1
13	2.2

The bits 5 and 6 are for setting phase shift among buck converters. The factory default value is channel 3 180° out-of-phase in respect to the channels 1 and 2 (10b).

D6	D5	Phase Shift
0	0	All converters operate in phase
0	1	Buck1 and Buck2/3 operate 180° out-of-phase
1	0	Buck1/2 and Buck3 operate 180° out-of-phase
1	1	Buck1/3 and Buck2 operate 180° out-of-phase

PWR Register (0Ah)

PWR register has 5 effective bits. The bits 0-2 select which channels will be enabled at transition of ENABLE pin from low to high. The state of the bit 3 determines whether buck converters operate in Pulse Skipping Mode or not. Setting this bit to 1 allows Pulse Skipping Mode operation to minimize power losses at light load levels. The bit 6 determines threshold voltage for V_{IN} UVLO. The factory default of this register is 7Fh.

Bit 7	Bit 6	Bit 5	Bit 4	Bit 3	Bit 2	Bit 1	Bit 0
X	UV	X	X	PSM	BUCK 3	BUCK 2	BUCK 1

		0	1
D0	BUCK 1	Not Used	Select
D1	BUCK 2	Not Used	Select
D2	BUCK 3	Not Used	Select
D3	PSM	Disable	Enable
D6	UV	4.2V	7V

Applications Information (Continued)

Typical Applications

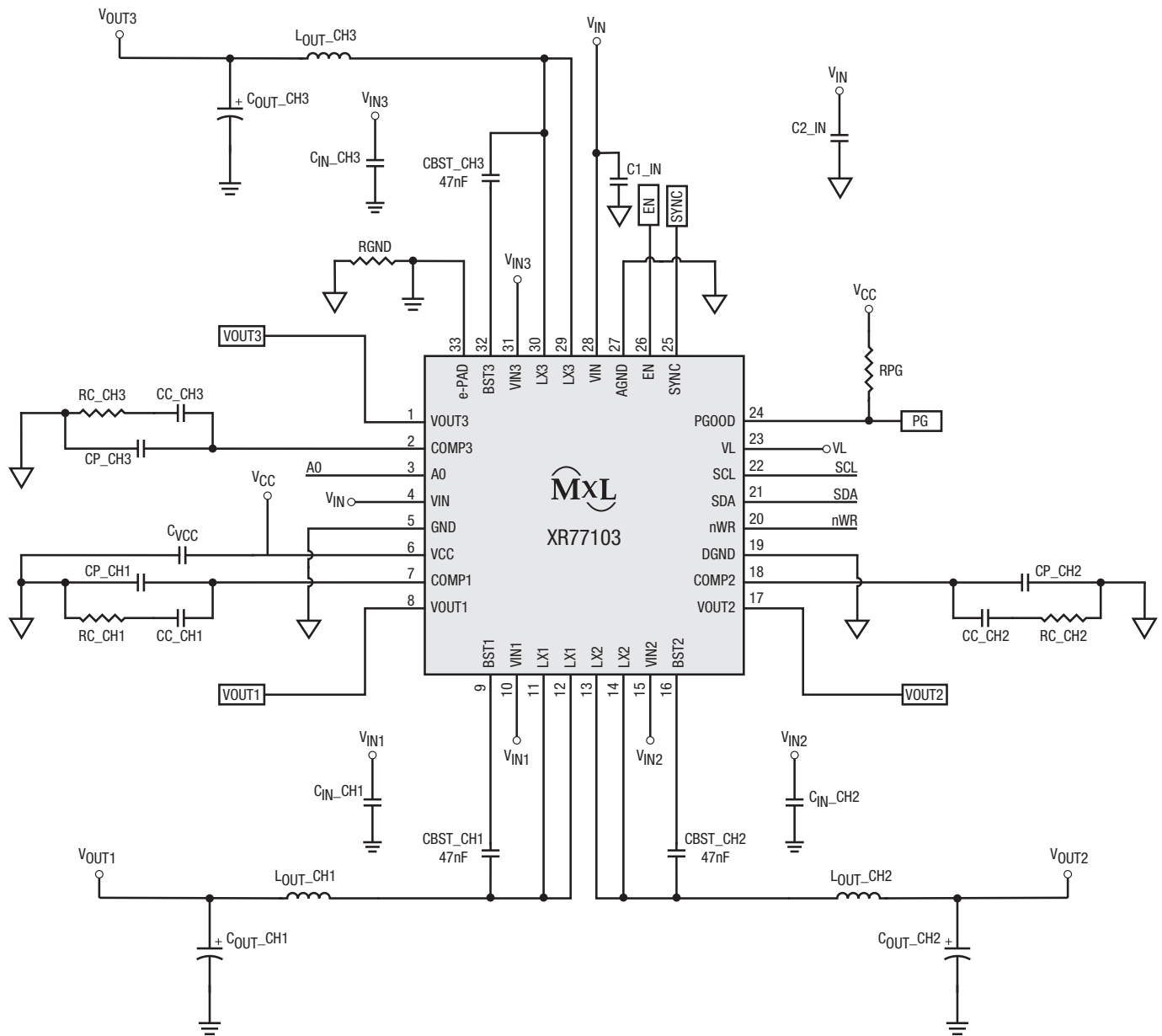
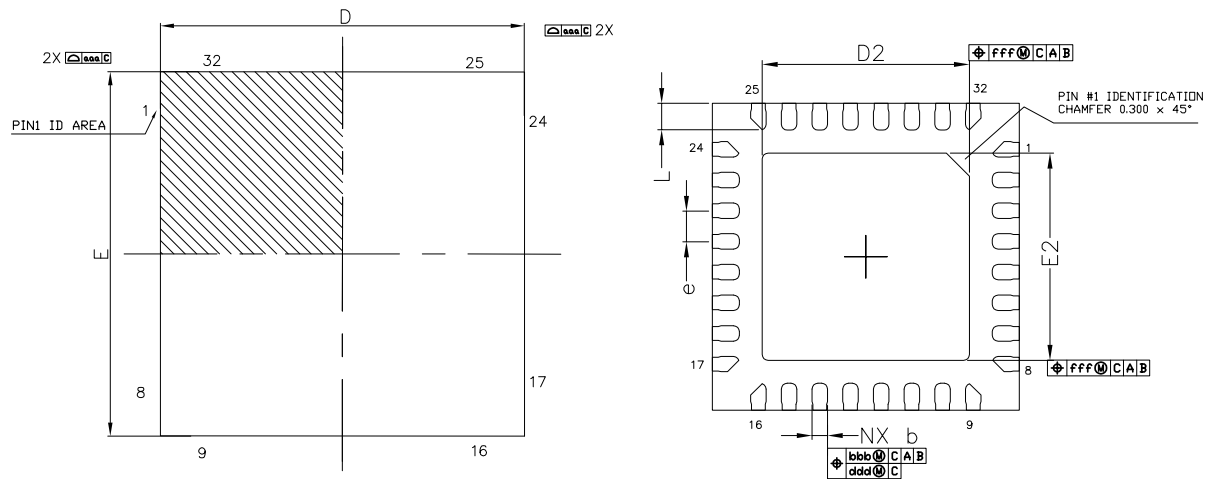

Figure 44. Typical Applications Schematic

Mechanical Dimensions



TOP VIEW

BOTTOM VIEW

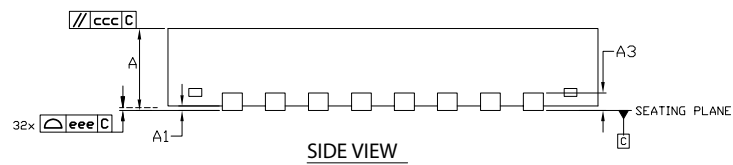

SIDE VIEW

DIM SYMBOL	MIN	NOM	MAX
A	0.70	0.75	0.80
A1	0.00	0.02	0.05
A3	0.203Ref		
b	0.15	0.20	0.25
D	4.00 BSC		
E	4.00 BSC		
e	0.40 BSC		
D2	2.65	2.70	2.75
E2	2.65	2.70	2.75
L	0.30	0.35	0.40
K	0.20	-	-
aaa		0.10	
bbb		0.10	
ccc		0.10	
ddd		0.05	
eee		0.08	
fff		0.10	
N		32	

TERMINAL DETAILS

- ALL DIMENSIONS ARE IN MILLIMETERS, ANGLES ARE IN DEGREES.
- DIMENSIONS AND TOLERANCE PER JEDEC MO-220.

Drawing No.: POD-0000079

Revision: C

Recommended Land Pattern and Stencil

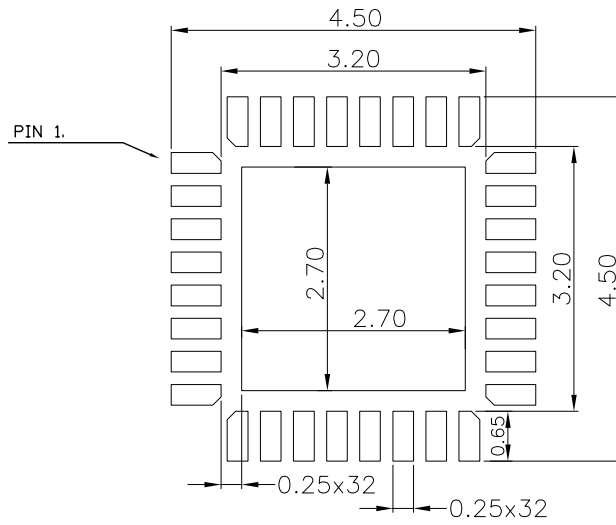

TYPICAL RECOMMENDED LAND PATTERN

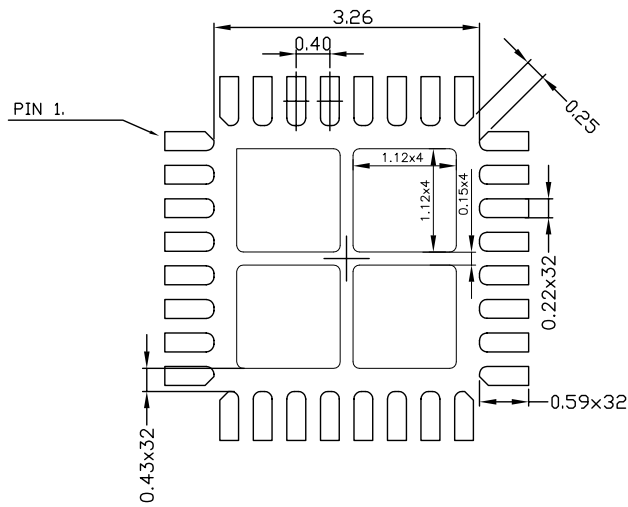

TYPICAL RECOMMENDED STENCIL

Drawing No.: POD-00000079

Revision: C

Order Information⁽¹⁾

Part Number	Operating Temperature Range	Lead-Free	Package	Packaging Method
XR77103ELB	-40°C ≤ T _J ≤ 125°C	Yes ⁽²⁾	32-pin, 4mm x 4mm TQFN package	Bulk
XR77103ELBTR				Tape and Reel
XR77103EVB-DEMO-1	XR77103 evaluation board			
XR77103EVB-DEMO-1-KIT	XR77103 evaluation board with interface board and software			

NOTE:

1. Refer to www.exar.com/XR77103 for most up-to-date Ordering Information.
2. Visit www.exar.com for additional information on Environmental Rating.

Revision History

Revision	Date	Description
1A	March 2016	Initial Release
1B	May 2016	Clarified Pin Descriptions. Added description for Continuous Conduction Mode and Pulse Skipping Mode. Added I ² C Bus Timing waveform and updated I ² C symbols and functional description. Added details for NVM programming and behavior. Added factory default NVM value to Register Map table. Updated Application Circuit. Updated layout guidelines.
1C	November 2017	Added MaxLinear logo. Updated format and ordering information format. Changed Packaging Description section name to Mechanical Dimensions and Recommended Land Pattern and Stencil. Corrected typo on Mechanical Dimensions, dimension A.



Corporate Headquarters:

5966 La Place Court
Suite 100
Carlsbad, CA 92008
Tel.: +1 (760) 692-0711
Fax: +1 (760) 444-8598
www.maxlinear.com

High Performance Analog:

1060 Rincon Circle
San Jose, CA 95131
Tel.: +1 (669) 265-6100
Fax: +1 (669) 265-6101
Email: powertechsupport@exar.com
www.exar.com

The content of this document is furnished for informational use only, is subject to change without notice, and should not be construed as a commitment by MaxLinear, Inc.. MaxLinear, Inc. assumes no responsibility or liability for any errors or inaccuracies that may appear in the informational content contained in this guide. Complying with all applicable copyright laws is the responsibility of the user. Without limiting the rights under copyright, no part of this document may be reproduced into, stored in, or introduced into a retrieval system, or transmitted in any form or by any means (electronic, mechanical, photocopying, recording, or otherwise), or for any purpose, without the express written permission of MaxLinear, Inc.

MaxLinear, Inc. does not recommend the use of any of its products in life support applications where the failure or malfunction of the product can reasonably be expected to cause failure of the life support system or to significantly affect its safety or effectiveness. Products are not authorized for use in such applications unless MaxLinear, Inc. receives, in writing, assurances to its satisfaction that: (a) the risk of injury or damage has been minimized; (b) the user assumes all such risks; (c) potential liability of MaxLinear, Inc. is adequately protected under the circumstances.

MaxLinear, Inc. may have patents, patent applications, trademarks, copyrights, or other intellectual property rights covering subject matter in this document. Except as expressly provided in any written license agreement from MaxLinear, Inc., the furnishing of this document does not give you any license to these patents, trademarks, copyrights, or other intellectual property.

Company and product names may be registered trademarks or trademarks of the respective owners with which they are associated.

© 2016 - 2017 MaxLinear, Inc. All rights reserved