



NPN SILICON RF TRANSISTOR NE66219 / 2SC5606

NPN SILICON RF TRANSISTOR FOR LOW NOISE · HIGH-GAIN AMPLIFICATION 3-PIN ULTRA SUPER MINIMOLD (19, 1608 PKG)

FEATURES

- Suitable for high-frequency oscillation
- $f_T = 25$ GHz technology adopted
- 3-pin ultra super minimold (19, 1608 PKG) package

<R> ORDERING INFORMATION

Part Number	Order Number	Package	Quantity	Supplying Form
NEC66219 2SC5606	NE66219-A 2SC5606-A	3-pin ultra super minimold (19, 1608 PKG) (Pb-Free)	50 pcs (Non reel)	• 8 mm wide embossed taping
NE66219-T1 2SC5606-T1	NE66219-T1-A 2SC5606-T1-A		3 kpcs/reel	• Pin 3 (collector) face the perforation side of the tape

Remark To order evaluation samples, please contact your nearby sales office.
The unit sample quantity is 50 pcs.

ABSOLUTE MAXIMUM RATINGS ($T_A = +25^\circ\text{C}$)

Parameter	Symbol	Ratings	Unit
Collector to Base Voltage	V_{CBO}	15	V
Collector to Emitter Voltage	V_{CEO}	3.3	V
Emitter to Base Voltage	V_{EBO}	1.5	V
Collector Current	I_C	35	mA
Total Power Dissipation	P_{tot} ^{Note}	115	mW
Junction Temperature	T_j	150	$^\circ\text{C}$
Storage Temperature	T_{stg}	-65 to +150	$^\circ\text{C}$

Note Mounted on $1.08\text{ cm}^2 \times 1.0\text{ mm}$ (t) glass epoxy substrate

Caution: Observe precautions when handling because these devices are sensitive to electrostatic discharge

The information in this document is subject to change without notice. Before using this document, please confirm that this is the latest version.

ELECTRICAL CHARACTERISTICS (T_A = +25°C)

Parameter	Symbol	Test Conditions	MIN.	TYP.	MAX.	Unit
DC Characteristics						
Collector Cut-off Current	I _{CB0}	V _{CB} = 5 V, I _E = 0 mA	–	–	200	nA
Emitter Cut-off Current	I _{EB0}	V _{EB} = 1 V, I _C = 0 mA	–	–	200	nA
DC Current Gain	h _{FE} ^{Note 1}	V _{CE} = 2 V, I _C = 5 mA	60	80	100	–
RF Characteristics						
Gain Bandwidth Product	f _T	V _{CE} = 2 V, I _C = 20 mA, f = 2 GHz	–	21	–	GHz
Insertion Power Gain	S _{21e} ²	V _{CE} = 2 V, I _C = 20 mA, f = 2 GHz	10	12.5	–	dB
Noise Figure	NF	V _{CE} = 2 V, I _C = 5 mA, f = 2 GHz, Z _S = Z _{opt}	–	1.2	1.5	dB
Reverse Transfer Capacitance	C _{re} ^{Note 2}	V _{CB} = 2 V, I _E = 0 mA, f = 1 MHz	–	0.21	0.3	pF
Maximum Available Power Gain	MAG ^{Note 3}	V _{CE} = 2 V, I _C = 20 mA, f = 2 GHz	–	14	–	dB
Maximum Stable Power Gain	MSG ^{Note 4}	V _{CE} = 2 V, I _C = 20 mA, f = 2 GHz	–	15	–	dB

- Notes 1.** Pulse measurement: PW ≤ 350 μs, Duty Cycle ≤ 2%
2. Collector to base capacitance when the emitter grounded

3. $MAG = \left| \frac{S_{21}}{S_{12}} \right| (K - \sqrt{K^2 - 1})$

4. $MSG = \left| \frac{S_{21}}{S_{12}} \right|$

h_{FE} CLASSIFICATION

<R>

Rank	FB/YFB
Marking	UA
h _{FE}	60 to 100

<R> TYPICAL CHARACTERISTICS (Unless otherwise specified, $T_A = +25^\circ\text{C}$)

TOTAL POWER DISSIPATION vs. AMBIENT TEMPERATURE

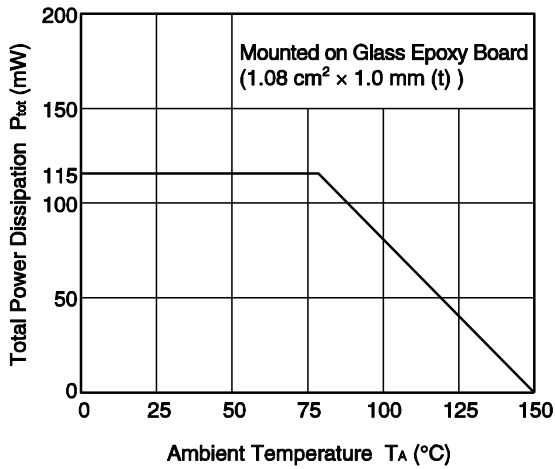

REVERSE TRANSFER CAPACITANCE vs. COLLECTOR TO BASE VOLTAGE

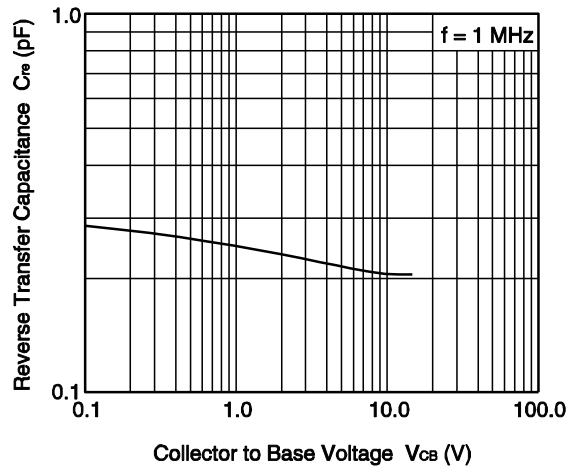

COLLECTOR CURRENT vs. BASE TO EMITTER VOLTAGE

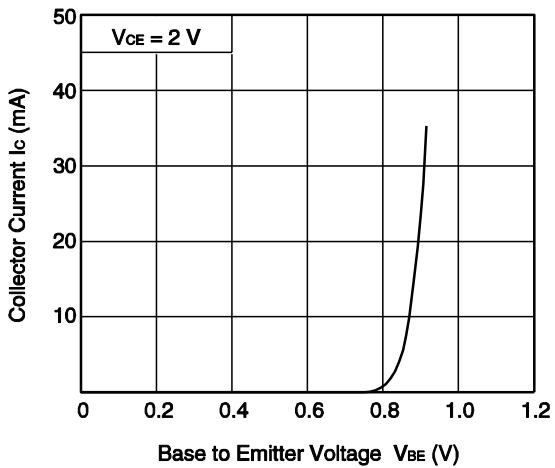

COLLECTOR CURRENT vs. COLLECTOR TO EMITTER VOLTAGE

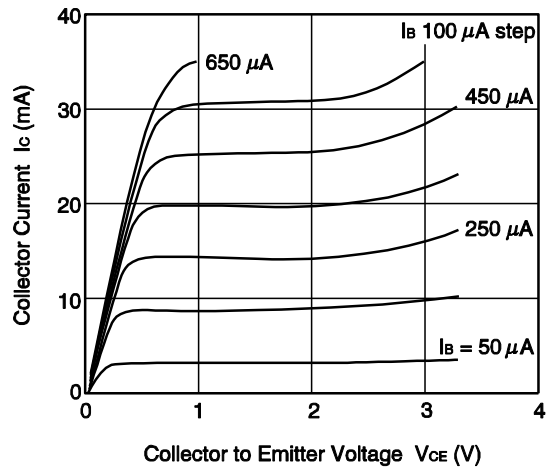

DC CURRENT GAIN vs. COLLECTOR CURRENT

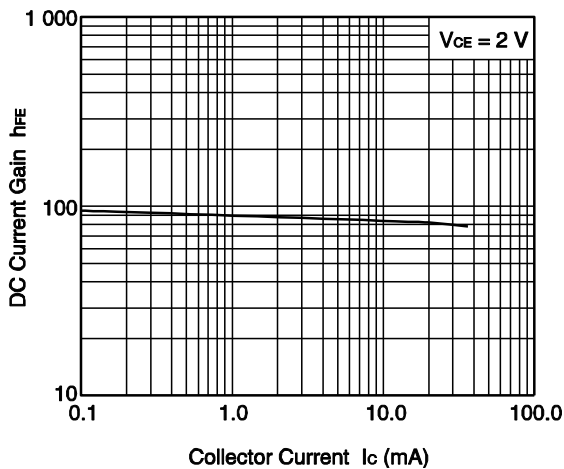

Remark The graphs indicate nominal characteristics.

GAIN BANDWIDTH PRODUCT vs. COLLECTOR CURRENT

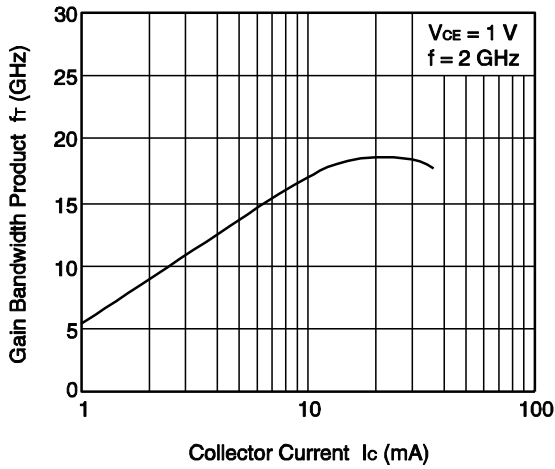

GAIN BANDWIDTH PRODUCT vs. COLLECTOR CURRENT

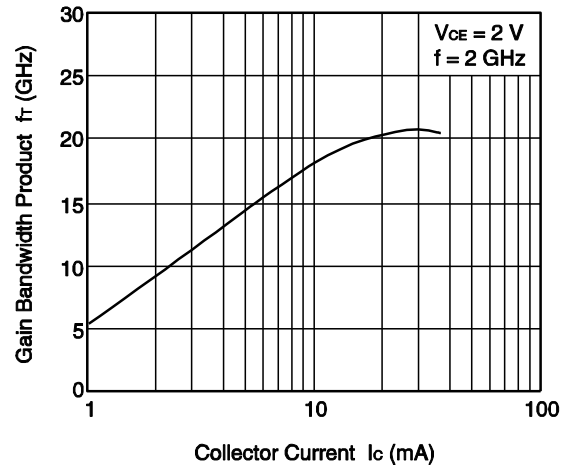

INSERTION POWER GAIN vs. FREQUENCY

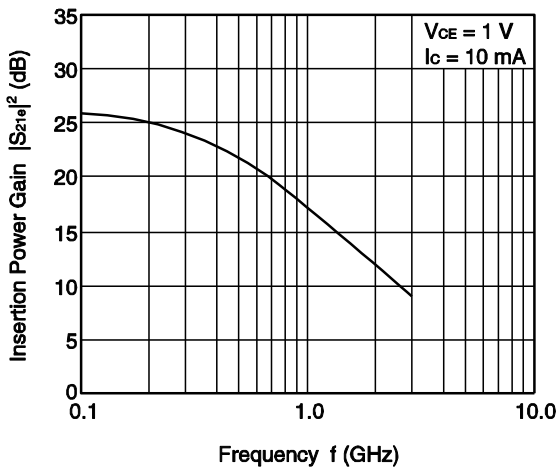

INSERTION POWER GAIN vs. FREQUENCY

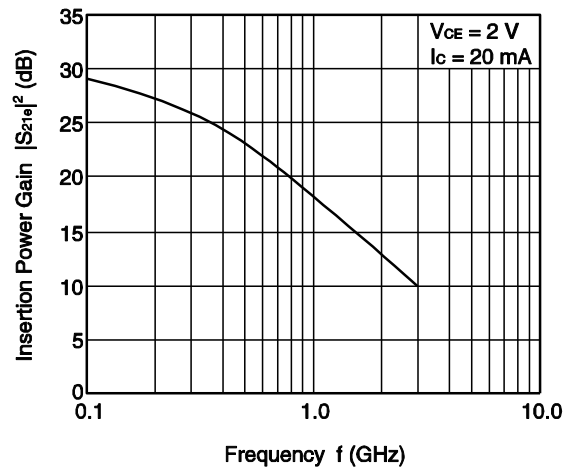

INSERTION POWER GAIN vs. COLLECTOR CURRENT

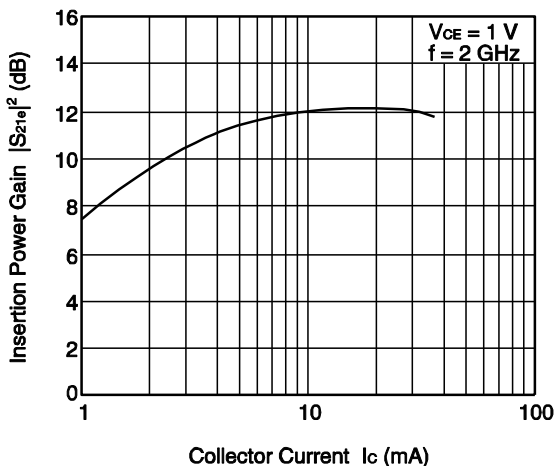

INSERTION POWER GAIN vs. COLLECTOR CURRENT

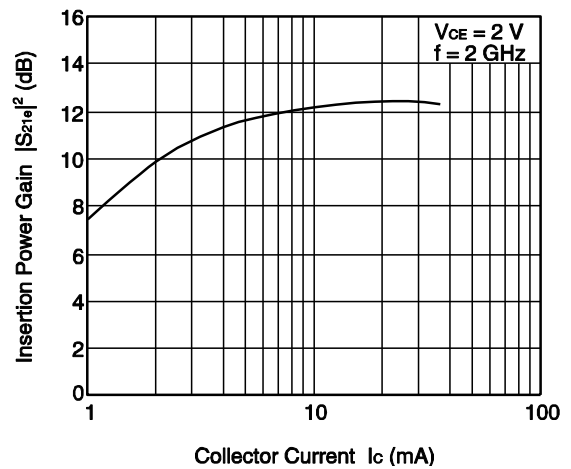

Remark The graphs indicate nominal characteristics.

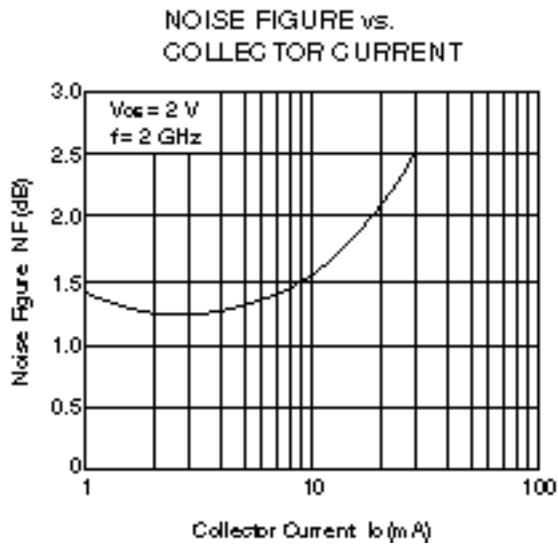

Remark The graph indicates nominal characteristics.

<R> **S-PARAMETERS**

- S-parameters and noise parameters are provided on our Web site in a format (S2P) that enables the direct import of the parameters to microwave circuit simulators without the need for keyboard inputs.
- Click here to download S-parameters.
- [RF and Microwave] @ [Device Parameters]
- URL <http://www.necel.com/microwave/en/>

PACKAGE DIMENSIONS

3-PIN ULTRA SUPER MINIMOLD (19, 1608 PKG) (UNIT: mm)

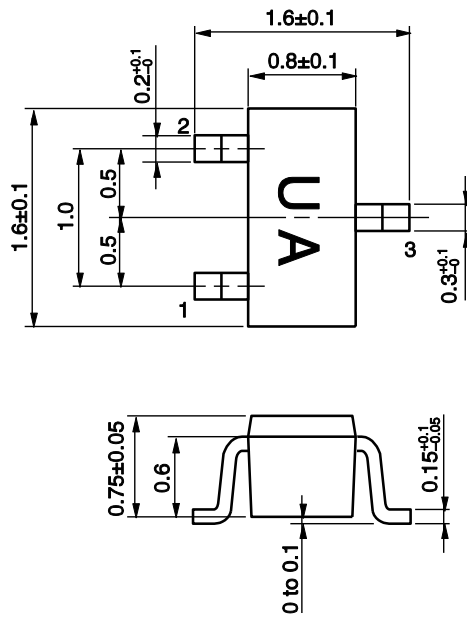

PIN CONNECTIONS

- 1. Emitter
- 2. Base
- 3. Collector