

---

**10Gb/s 1310nm SFP+ 10km Transceiver****PART NUMBER: SFPPT-LR1-01****PRODUCT FEATURES**

- Up to 11.1Gbps Data Links
- Up to 10km transmission on SMF
- DFB Laser and PIN receiver
- Metal enclosure, for lower EMI
- 2-wire interface with integrated Digital Diagnostic monitoring
- Hot-pluggable SFP+ footprint
- Specifications compliant with SFF 8472
- Compliant with SFP+ MSA with LC connector
- Single 3.3V power supply
- Case operating temperature range: 0°C to 70°C
- Power dissipation < 1.5 W

**APPLICATIONS**

- 10GBASE-LR/LW & 10G Ethernet

<u>PART NUMBER</u>	<u>DFTO</u>	<u>DATE</u>	<u>REVISION</u>	<u>SHEET NO</u>		
SFPPT-LR1-01	ELLA	15 Sep., 2014	P1	1	OF	9

## 10Gb/s 1310nm SFP+ 10km Transceiver

### STANDARD

- Compliant to SFF-8431
- Compliant to SFF 8472
- RoHS Compliant.

### I Absolute Maximum Ratings

Parameter	Symbol	Min.	Typ.	Max.	Unit	Note
Storage Temperature	Ts	-40	-	85	°C	
Storage Ambient Humidity	HA	5	-	95	%	
Operating Relative Humidity	RH	-	-	85	%	
Power Supply Voltage	VCC	-0.3	-	4	V	
Signal Input Voltage		Vcc-0.3	-	Vcc+0.3	V	

### II Recommended Operating Conditions

Parameter	Symbol	Min.	Typ.	Max.	Unit	Note
Case Operating Temperature	Tcase	0	-	70	°C	Without air flow
Power Supply Voltage	VCC	3.14	3.3	3.47	V	
Power Supply Current	ICC	-	270	350	mA	
Data Rate	BR		10.3125		Gbps	
Transmission Distance	TD		-	10	km	
Coupled fiber	Single mode fiber					9/125um SMF

PART NUMBER	<u>DFTO</u>	<u>DATE</u>	<u>REVISION</u>	<u>SHEET NO</u>		
SFPPT-LR1-01	ELLA	15 Sep., 2014	P1	2	OF	9

## 10Gb/s 1310nm SFP+ 10km Transceiver

### III Optical Characteristics

Parameter	Symbol	Min	Typ	Max	Unit	NOTE
<b>Transmitter</b>						
Output Opt. Pwr	P <sub>OUT</sub>	-6		-1	dBm	1
Optical Wavelength	$\lambda$	1260	1310	1355	nm	
Spectral Width (-20dB)	$\sigma$			1	nm	
Optical Extinction Ratio	ER	3.5			dB	
Transmitter and Dispersion Penalty	TDP			3.2	dB	
RIN	RIN			-128	dB/Hz	
Output Eye Mask	Compliant with IEEE 802.3ae					
<b>Receiver</b>						
Rx Sensitivity	R <sub>SENS</sub>			-14.4	dBm	2
Input Saturation Power (Overload)	P <sub>sat</sub>	0.5			dBm	
Wavelength Range	$\lambda_c$	1270		1610	nm	
LOS De -Assert	LOSD			-17	dBm	
LOS Assert	LOSA	-30			dBm	
LOS Hysteresis		0.5	1.0		dB	

**Notes:**

1. Class 1 Laser Safety per FDA/CDRH and IEC-825-1 regulations.

2. Measured with a PRBS  $2^{31}-1$  test pattern, @10.325Gb/s, BER <  $10^{-12}$ .

PART NUMBER	DFTO	DATE	REVISION	SHEET NO		
SFPPT-LR1-01	ELLA	15 Sep., 2014	P1	3	OF	9

## 10Gb/s 1310nm SFP+ 10km Transceiver

### IV. Electrical Characteristics

Parameter	Symbol	Min	Typ	Max	Unit	NOTE
Supply Voltage	Vcc	3.14	3.3	3.46	V	
Supply Current	Icc			350	mA	
<b>Transmitter</b>						
Input differential impedance	Rin		100		Ω	1
Single ended data input swing	Vin,pp	180		700	mV	
Transmit Disable Voltage	VD	Vcc-1.3		Vcc	V	
Transmit Enable Voltage	VEN	Vee		Vee+ 0.8	V	2
Transmit Disable Assert Time				10	us	
<b>Receiver</b>						
Differential data output swing	Vout,pp	300		850	mV	3
Data output rise time	tr	28			ps	4
Data output fall time	tf	28			ps	4
LOS Fault	VLOS fault	Vcc-1.3		VccHOST	V	5
LOS Normal	VLOS norm	Vee		Vee+0.8	V	5
Power Supply Rejection	PSR	100			mVpp	6

#### Notes:

1. Connected directly to TX data input pins. AC coupled thereafter.
2. Or open circuit.
3. Into 100 ohms differential termination.
4. 20 – 80 %.
5. Loss Of Signal is LVTTTL. Logic 0 indicates normal operation; logic 1 indicates no signal detected.
6. Receiver sensitivity is compliant with power supply sinusoidal modulation of 20 Hz to 1.5 MHz up to specified value applied through the recommended power supply filtering network.

PART NUMBER	<u>DFTO</u>	<u>DATE</u>	<u>REVISION</u>	<u>SHEET NO</u>		
SFPPT-LR1-01	ELLA	15 Sep., 2014	P1	4	OF	9

## 10Gb/s 1310nm SFP+ 10km Transceiver

### V. Pin Assignment

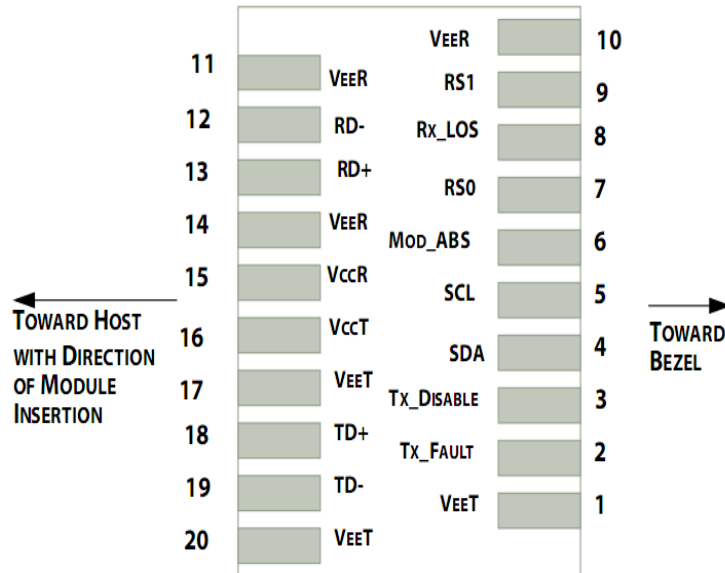

Pin out of Connector Block on Host Board

Pin	Symbol	Name/Description	NOTE
1	V <sub>EET</sub>	Transmitter Ground (Common with Receiver Ground)	1
2	T <sub>FAULT</sub>	Transmitter Fault.	2
3	T <sub>DIS</sub>	Transmitter Disable. Laser output disabled on high or open.	3
4	SDA	2-wire Serial Interface Data Line	4
5	SCL	2-wire Serial Interface Clock Line	4
6	MOD_ABS	Module Absent. Grounded within the module	4
7	RS0	Rate Select 0	5
8	LOS	Loss of Signal indication. Logic 0 indicates normal operation.	6
9	RS1	No connection required	1
10	V <sub>EER</sub>	Receiver Ground (Common with Transmitter Ground)	1
11	V <sub>EER</sub>	Receiver Ground (Common with Transmitter Ground)	1
12	RD-	Receiver Inverted DATA out. AC Coupled	

PART NUMBER	DFTO	DATE	REVISION	SHEET NO		
SFPPT-LR1-01	ELLA	15 Sep., 2014	P1	5	OF	9

## 10Gb/s 1310nm SFP+ 10km Transceiver

13	RD+	Receiver Non-inverted DATA out. AC Coupled	
14	V <sub>EER</sub>	Receiver Ground (Common with Transmitter Ground)	1
15	V <sub>CCR</sub>	Receiver Power Supply	
16	V <sub>CCT</sub>	Transmitter Power Supply	
17	V <sub>EET</sub>	Transmitter Ground (Common with Receiver Ground)	1
18	TD+	Transmitter Non-Inverted DATA in. AC Coupled.	
19	TD-	Transmitter Inverted DATA in. AC Coupled.	
20	V <sub>EET</sub>	Transmitter Ground (Common with Receiver Ground)	1

### Notes:

1. Circuit ground is internally isolated from chassis ground.
2. T<sub>FAULT</sub> is an open collector/drain output, which should be pulled up with a 4.7k – 10k Ohms resistor on the host board if intended for use. Pull up voltage should be between 2.0V to Vcc + 0.3V. A high output indicates a transmitter fault caused by either the TX bias current or the TX output power exceeding the preset alarm threshold. A low output indicates normal operation. In the low state, the output is pulled to <0.8V.
3. Laser output disabled on T<sub>DIS</sub> >2.0V or open, enabled on T<sub>DIS</sub> <0.8V.
4. Should be pulled up with 4.7kΩ- 10kΩ host board to a voltage between 2.0V and 3.6V. MOD\_ABS pulls line low to indicate module is plugged in.
5. Internally pulled down per SFF-8431 Rev 4.1.
6. LOS is open collector output. It should be pulled up with 4.7kΩ – 10kΩ on host board to a voltage between 2.0V and 3.6V. Logic 0 indicates normal operation; logic 1 indicates loss of signal.

## VI. Digital Diagnostic Functions

SFPPT-LR1-01 transceivers support the 2-wire serial communication protocol as defined in the SFP+ MSA.

The standard SFP serial ID provides access to identification information that describes the transceiver’s capabilities, standard interfaces, manufacturer, and other information.

Additionally, SFP+ transceivers provide a unique enhanced digital diagnostic monitoring interface, which allows

PART NUMBER	DFTO	DATE	REVISION	SHEET NO		
SFPPT-LR1-01	ELLA	15 Sep., 2014	P1	6	OF	9

---

**10Gb/s 1310nm SFP+ 10km Transceiver**

real-time access to device operating parameters such as transceiver temperature, laser bias current, transmitted optical power, received optical power and transceiver supply voltage. It also defines a sophisticated system of alarm and warning flags, which alerts end-users when particular operating parameters are outside of a factory set normal range.

The SFP MSA defines a 256-byte memory map in EEPROM that is accessible over a 2-wire serial interface at the 8 bit address 1010000X (A0h). The digital diagnostic monitoring interface makes use of the 8 bit address 1010001X (A2h), so the originally defined serial ID memory map remains unchanged.

The operating and diagnostics information is monitored and reported by a Digital Diagnostics Transceiver Controller (DDTC) inside the transceiver, which is accessed through a 2-wire serial interface. When the serial protocol is activated, the serial clock signal (SCL, Mod Def 1) is generated by the host. The positive edge clocks data into the SFP transceiver into those segments of the E2PROM that are not write-protected. The negative edge clocks data from the SFP transceiver. The serial data signal (SDA, Mod Def 2) is bi-directional for serial data transfer. The host uses SDA in conjunction with SCL to mark the start and end of serial protocol activation. The memories are organized as a series of 8-bit data words that can be addressed individually or sequentially.

<u>PART NUMBER</u>	<u>DFTO</u>	<u>DATE</u>	<u>REVISION</u>	<u>SHEET NO</u>		
SFPPT-LR1-01	ELLA	15 Sep., 2014	P1	7	OF	9

## 10Gb/s 1310nm SFP+ 10km Transceiver

### VII. Host - Transceiver Interface Block Diagram

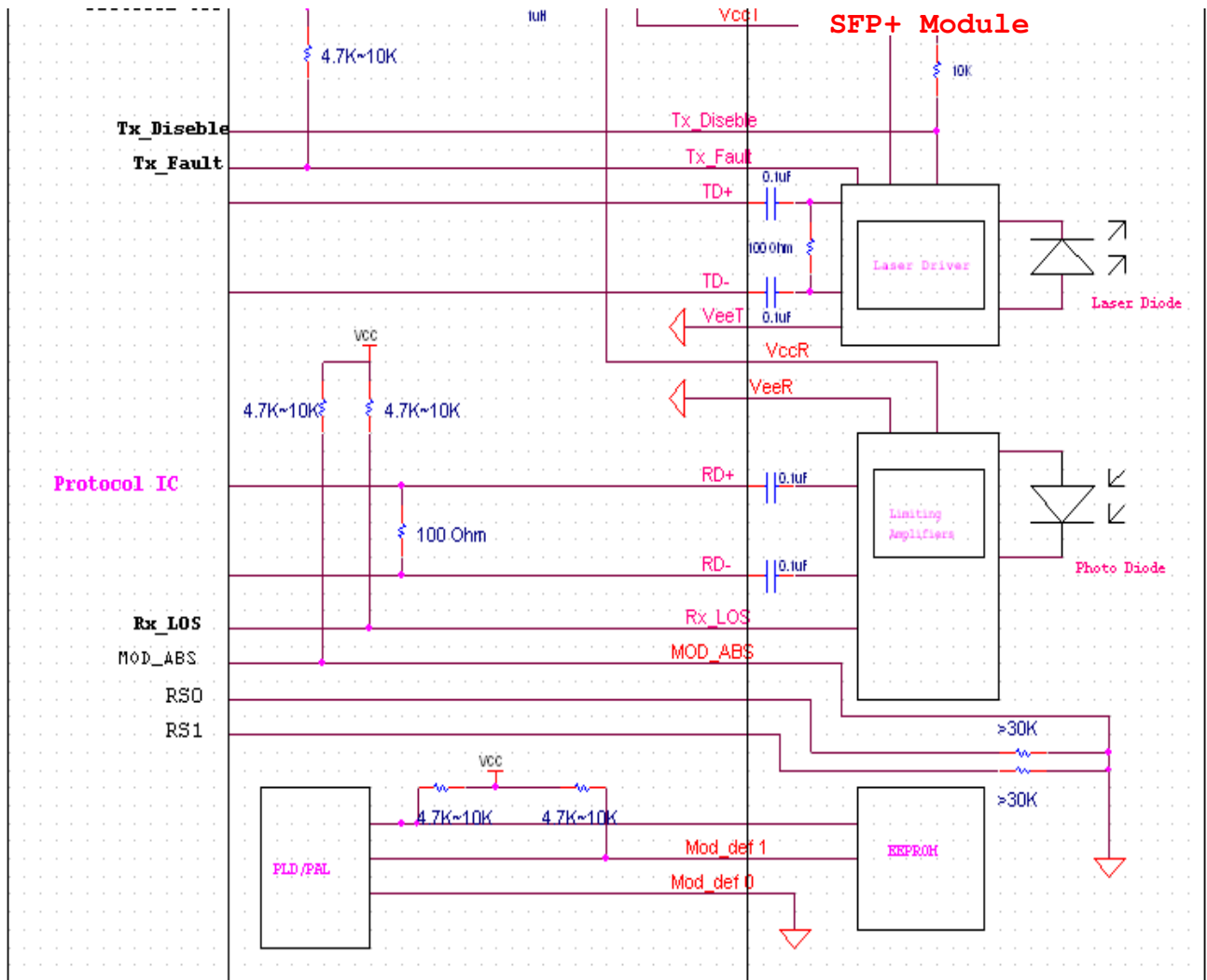

PART NUMBER	DFTO	DATE	REVISION	SHEET NO		
SFPPT-LR1-01	ELLA	15 Sep., 2014	P1	8	OF	9



## 10Gb/s 1310nm SFP+ 10km Transceiver

### VIII. Outline Dimensions

Comply to SFF-8432 rev. 5.0, the improved Pluggable form factor specification.

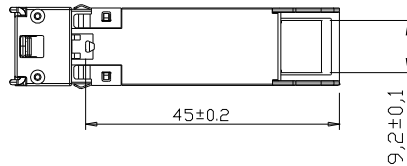
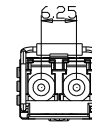
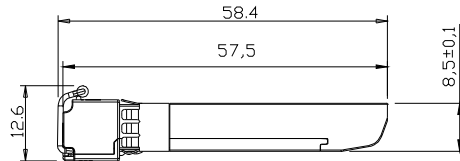
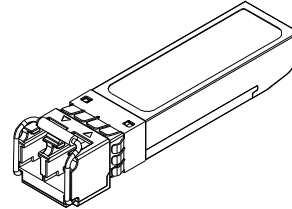
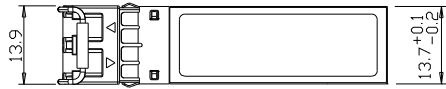

Units in mm

### IX. Regulatory Compliance

Feature	Reference	Performance
Electrostatic discharge (ESD)	IEC/EN 61000-4-2	Compatible with standards
Electromagnetic Interference (EMI)	FCC Part 15 Class B EN 55022 Class B (CISPR 22A)	Compatible with standards
Laser Eye Safety	FDA 21CFR 1040.10, 1040.11 IEC/EN 60825-1, 2	Class 1 laser product
Component Recognition	IEC/EN 60950, UL	Compatible with standards
ROHS	2002/95/EC	Compatible with standards
EMC	EN61000-3	Compatible with standards

PART NUMBER	DFTO	DATE	REVISION	SHEET NO		
SFPPT-LR1-01	ELLA	15 Sep., 2014	P1	9	OF	9