

PART NO.	ENG. NO.
02-09-2118	1380-(P901)L
02-09-2116	1380-(P901)
02-09-2127	1380-(P901)1
02-09-6126	1380-(591)L
02-09-6125	1380-(591)
02-09-6123	1380-(550)L
02-09-6122	1380-(550)
02-09-2119	1380-A(P901)L
02-09-2117	1380-A(P901)

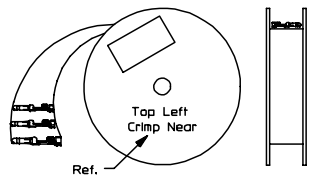

REWOUND CHAIN

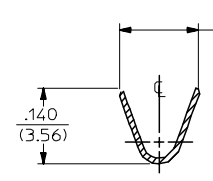
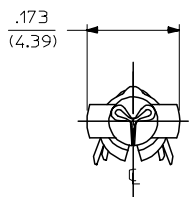

SECT. "A-A"

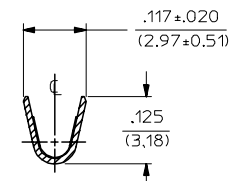

SECT. "B-B"

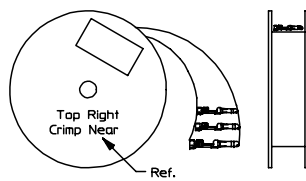

STANDARD CHAIN

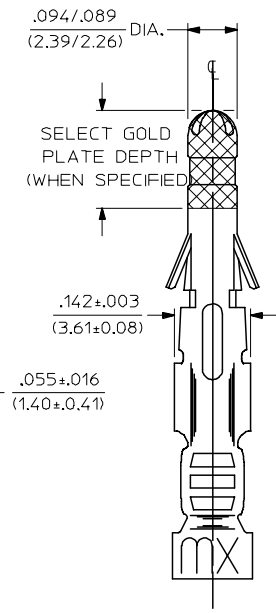
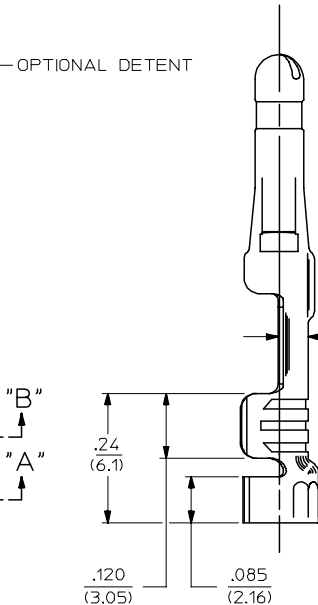
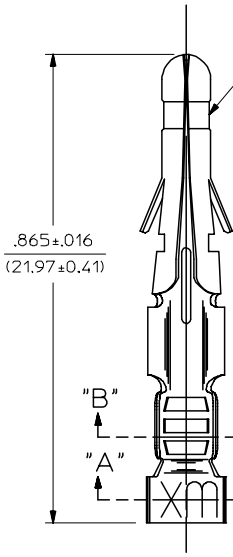

LEGEND

1380-*(***)*
 OPTIONAL DETENT
 BLANK = WITH DETENT
 A = WITHOUT DETENT

P = PREPLATE
 BLANK = POSTPLATE

FORM
 BLANK = STD. CHAIN
 A = REWOUND CHAIN
 L = LOOSE
 1 = STD. CHAIN WITH INTERLEAF PAPER

FINISH CODE
 (SEE NOTE 2)

NOTES:

- MATERIAL: BRASS
- FINISH:
 - 999 UNPLATED
 - 901 HOT TIN DIP .000020/(0.00051) MIN.
 - 591 SELECT GOLD PLATE .000050/(0.00127) MIN. IN CONTACT AREA, OVER .000050/(0.00127) MIN. NICKEL OVERALL WITH .000010/(0.00025) MAX. GOLD FLASH OVERALL.
 - 550 SELECT GOLD PLATE .000015/(0.00038) MIN. IN CONTACT AREA, OVER .000030/(0.00076) MIN. NICKEL OVERALL WITH .000010/(0.00025) MAX. GOLD FLASH OVERALL.
- PRODUCT SPECIFICATION: PS-02-09.
- PACKAGING INFORMATION: NOT AVAILABLE
- TERMINAL FOR USE WITH .093/(2.36) SERIES HOUSINGS AND WILL ACCEPT 18 THRU 22 AWG
- INSERTION FORCE: 3.5 LBS. MAX. WHEN TERMINAL IS INSERTED INTO AN .093 SERIES HOUSING.
- TERMINAL RETENTION: 20 LBS. MIN. FROM HOUSING.

REVISED/REDRAWN EC NO: UCP2004-2354 DRAWN:RHOLTS 2005/07/20 CHKD:FSMITH 2005/07/20 APPR:FSMITH 2005/07/20 BV	QUALITY SYMBOLS	GENERAL TOLERANCES (UNLESS SPECIFIED)	SCALE 6:1	DESIGN UNITS INCH	THIRD ANGLE PROJECTION	REVISE ON CAD ONLY
	DESCRIPTION	mm	DIMENSION STYLE IN/MM		TITLE CRIMP TERMINAL .093 DIA., MALE FOR 18 THRU 22 AWG. WIRE	
		INCH	DRAWN BY DATE GEP 1987/11/06			
		4 PLACES ± --- ± --- 3 PLACES ± --- ± .010 2 PLACES ± 0.25 ± .14 1 PLACE ± 0.35 ± --- ANGULAR ±1/2°	CHECKED BY DATE RW 1987/11/06		APPROVED BY DATE RAS 1987/11/06	
DRAFT WHERE APPLICABLE MUST REMAIN WITHIN DIMENSIONS			THIS DRAWING CONTAINS INFORMATION THAT IS PROPRIETARY TO MOLEX INCORPORATED AND SHOULD NOT BE USED WITHOUT WRITTEN PERMISSION			