

6Z80E0RS
(ON 0NIMAYO)号图

| SYM. 版数 | DCN NO. | DESCRIPTION 変更内容 | DATE 年月日 | DRAWN 製図 | CHECKED 担当 | APP'D 査閲 | APP'D 承認 |
|------------|---------|---------------------|-------------|-------------|---------------|-------------|-------------|
| | | | | | | | |
| | | | | | | | |

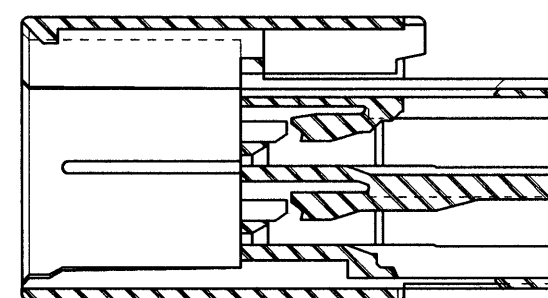

SECT. A-A

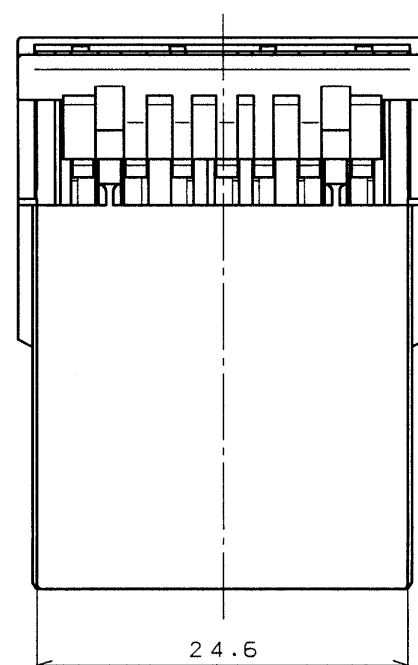
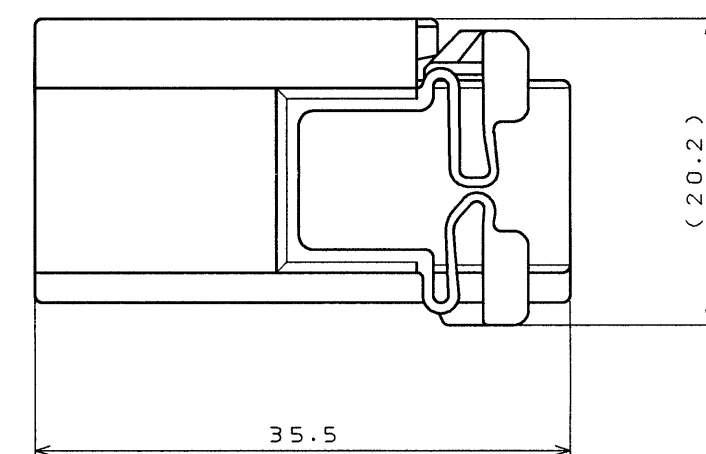
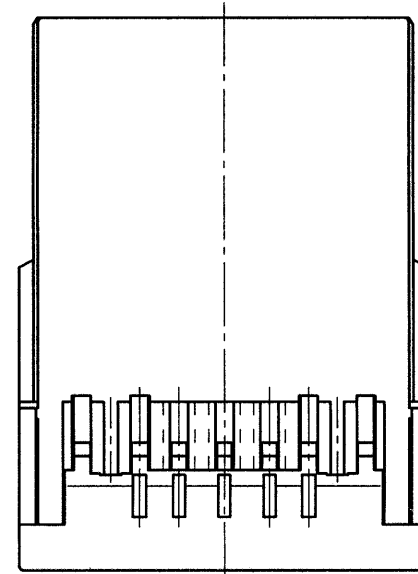
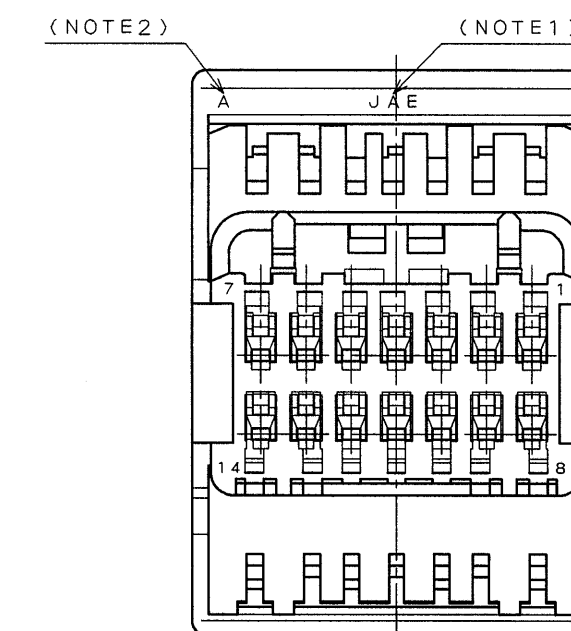
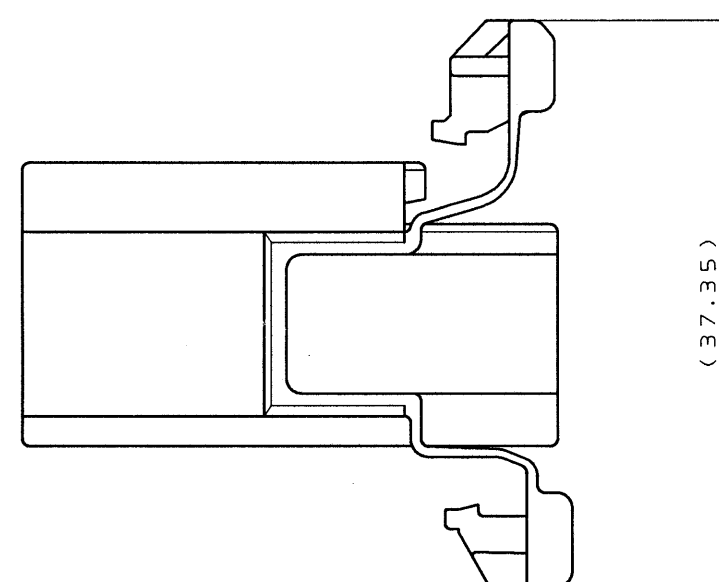
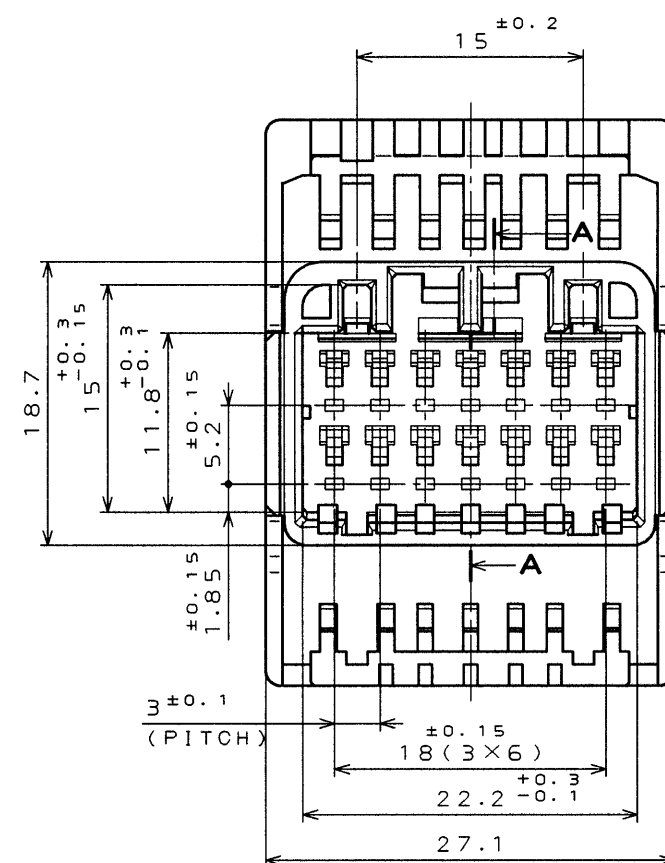

REFERENCE

NOTE1. COMPANY LOGO "JAE" APPEARS IN RAISED LETTERS.
 2. CAVITY NUMBER APPEARS IN RAISED LETTERS.
 1. 社標を浮き出す。
 2. キャビNo.を浮き出す。

| ITEM 符号 | PIN HOUSING DESCRIPTION 名称 | Q'TY 個数 | PBT MATERIAL 材料 | FINISH 仕上 | COLOR: LIGHT BLUE REMARKS 備考 |
|-------------------------|-------------------------------------|--------------------------|-------------------------------------|-----------------------|------------------------------------|
| 仕様書(REFERENCE DOCUMENT) | 第1版(DATE) 10. Jan. '97 | 尺度(SCALE) 2 | JAE-CONNECTOR.COM Reference Only | | |
| 公差(GENERAL TOLERANCE) | 製図(DR.) M. KUROIWA | 名称(TITLE) MX5-A-14P-C | | JAE INDUSTRY, LTD. | |
| 寸法(DIMENSION) | 角度(ANGLES) ° ± X° ± X°X' ± | 担当(CHK.) K. HASEBE | PIN HOUSING | | 図面番号(DRAWING NO.) SJ030829 |
| · ± | ·X ±0.5 | 査閲(APP.) A. Sakai | シリーズ(SERIES) MX5 | 版数(SYM.) 1 | |
| ·XX ±0.5 | ·XXX ± | 承認(APP.) S. Imori | 日本航空電子工業株式会社 | | |

THIS DRAWING CONTAINS INFORMATION THAT IS PROPRIETARY TO JAE AND SHOULD NOT BE USED WITHOUT WRITTEN PERMISSION.
 本図面は日本航空電子工業(株)の所有する情報を含むもので当社の許可なく複製を禁止する。

DCF-C-213B(PE.03)

0 10 20 30 40 50 60 70 80 90 100

CDS-06-110-10248

SIZE A2