



## **ECP5™ PCI Express Board**

---

**User's Guide**

## Introduction

The ECP5™ PCI Express Board allows designers to investigate and experiment with the features of the ECP5 Field-Programmable Gate Array. The features of the ECP5 PCI Express Board can assist engineers with rapid prototyping and testing of their specific designs. The guide is intended to be referenced in conjunction with demo user's guides to demonstrate the ECP5 FPGA.

**Figure 1. ECP5 PCI Express Board, Top Side**

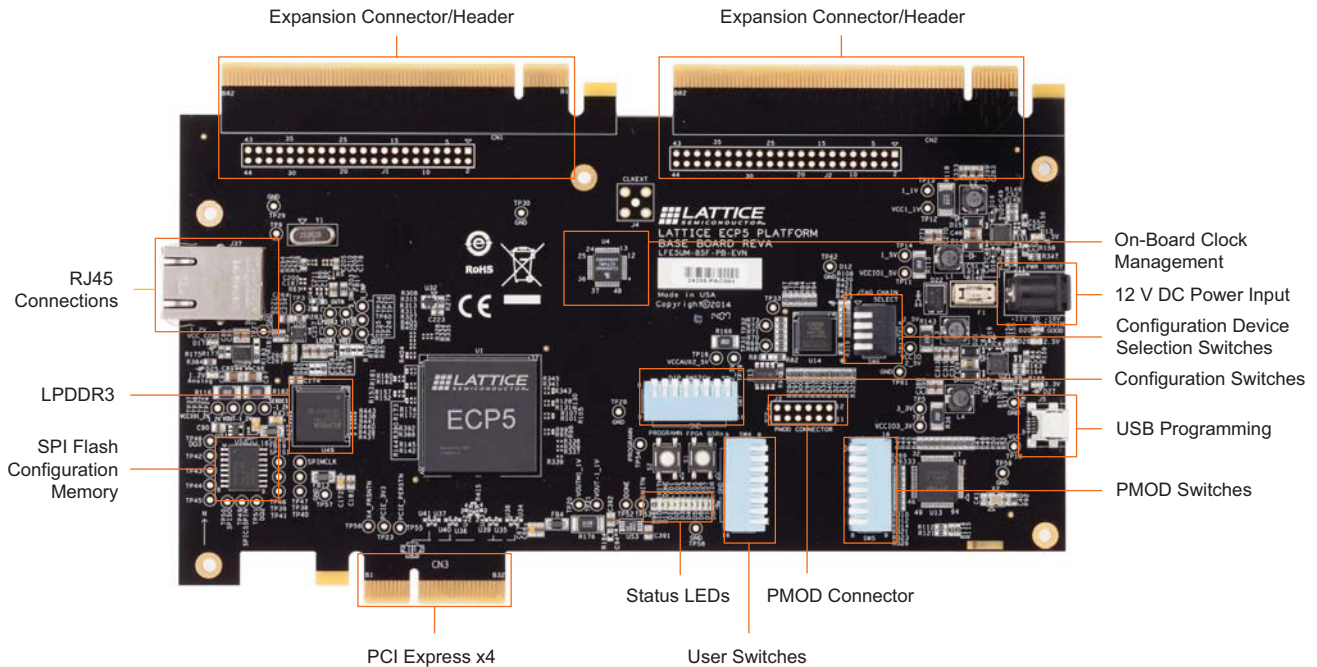

## Features

- PCI Express form-factor
  - Allows demonstration of PCI Express x4 interconnection
- USB-B connection for UART and device programming
- One RJ45 interfaces to 10/100/1000 Ethernet to RGMII
- On-board Boot Flash
  - 128M Serial SPI Flash
- 8GB LPDDR3 memory components (256Mbx32)
- Expansion connections and headers
  - Allows flexibility for user prototype expansion
- Switches, LEDs and displays for demo purposes
- Lattice Diamond® Programmer configuration support
- On-board reference clock sources
- Easy power measurements
  - All ECP5 rails have probable power resistors

The contents of this user's guide include top-level functional descriptions of the various portions of the evaluation board, descriptions of the on-board connectors, diodes and switches and a complete set of schematics.

*Caution: The ECP5 PCI Express Board contains ESD-sensitive components. ESD safe practices should be followed while handling and using the evaluation board.*

## ECP5 Device

This board features an ECP5 FPGA in a 756-ball caBGA with a 1.1 V core supply. A complete description of this device can be found in DS1044, [ECP5 Family Data Sheet](#).

*Note: The connections referenced in this document refer to the LFE5UM-85F-7MG756BC device.*

## Applying Power to the Board

The ECP5 PCI Express Board is ready to power on. The board can be supplied with power from a PCI Express host system or standalone with an external wall power module.

The 12 V DC input power source is fused with a surface mounted fuse, as noted in Table 1.

**Table 1. Board Power Supply Fuses** (See Appendix B, "Power Supplies" sheet)

Fuse Designator	Description
F1	12 V Input Supply Fuse

The board may be plugged into a host PC. Only plug the board into a PCI Express slot when the system is powered off. Once inserted, the PC can be safely powered on.

Using the evaluation board outside of a PC chassis supply requires the factory-supplied wall supply module. Use of other supplies is not suggested.

**Figure 2. Power Distribution Scheme** (See Appendix B, "Power Supplies" sheet)

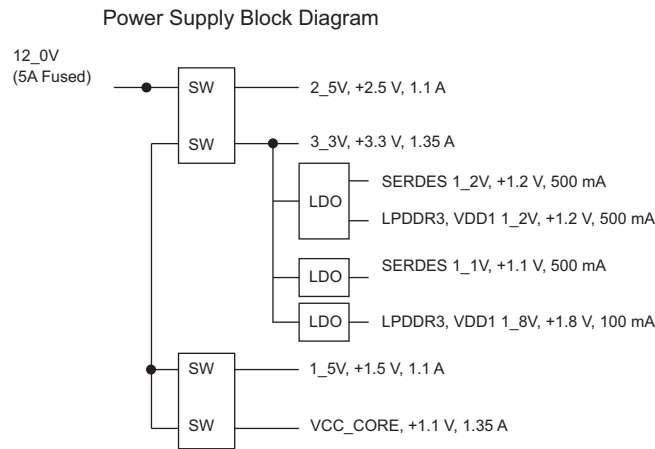

## Programming/FPGA Configuration

The ECP5 PCI Express Board has a built-in download controller for programming the ECP5 FPGA. The built-in module consists of a USB Type-B connector and a USB UART device. To use the built-in download cable, simply connect a standard USB cable (a USB-B to USB-A cable is included with the ECP5 PCI Express Board) from J5 to

your PC (with Diamond Programmer software installed). The USB hub on the PC will detect the addition of the USB function, making the built-in cable available for use with the Diamond Programmer software.

## Diamond Programmer Requirements

*Note: This board includes the built-in download module and only requires the USB cable included with the board.*

After initial board setup, use the following procedure to program the board. Instructions assume that Diamond Programmer software has been installed on a local PC.

### Requirements:

- PC with Diamond Programmer 3.2 (or later) programming software, installed with appropriate drivers (USB driver for USB cable).

*Note: An option to install these drivers is included as part of the Diamond Programmer setup.*

## Board Programming

**Configuration Status Indicators** (See Appendix B, "XO2 Configuration Mux" sheet)

**Figure 3. PCI Express Board Configuration/Programming Mux Selection**



SW6 is used to select the device to program on the ECP5 PCI Express Board (1=Up, 0=Down).

SW6[1:4]	Device Selected to Program or Configure
1111	MachXO2-640 (JTAG Mux). Note This device must be programmed before Programming or Configuring other devices. This device is pre-programmed during the boards manufacturing.
0000	ECP5UM-85
0001	ispClock-5304 (Clock Management) This device is controls the clock management on the board. This device is pre-programmed during the boards manufacturing.
0010	Expansion Card on CN1 Connector (Left)
0100	Expansion Card on CN2 Connector (Right)

SW7 includes the ECP5 CFG pins (1=Up, 0=Down) which allow the configuration mode of the ECP5 to be selected. Switches are the right side of SW7 where SW7[1]=CFG0, SW7[2]=CFG1, SW7[3]=CFG2

Figure 4. ECP5 Configuration Pin (CFG pins)

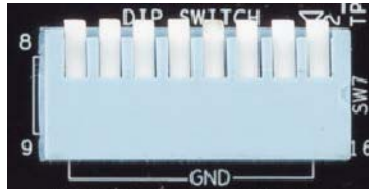
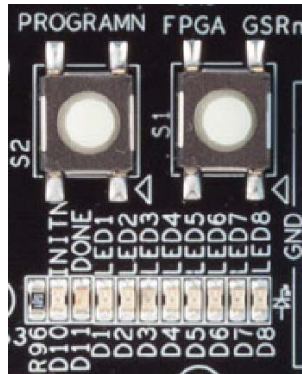

Figure 5. ECP5 Status LEDs and Push-button Controls



The LEDs indicate the configuration status of the ECP5 FPGA.

- D10 (red) illuminated indicates that programming was aborted or reinitialized, driving the INITN output low.
- D11 (green) illuminated indicates the successful completion of configuration by releasing the open collector DONE output pin.

### PROGRAMN and GSRN

These push-button switches assert/de-assert the logic levels on PROGRAMN (S2) and GSRN (S1). Depressing the button drives a logic level “0” to the device.

### Programming Serial SPI Flash Memory

A serial SPI (16-pin TSSOP, 128Mb) Flash memory device (U52) is on-board for non-volatile configuration memory storage. A Micron N25Q128A device is populated on-board.

The Serial SPI Flash memory device can be configured easily via the ECP5 JTAG port. This mode enables the FPGA to be programmed at power-up or assertion of PROGRAMN with a bitstream stored in the memory device.

1. Connect the ECP5 PCI Express Board.
2. Scan the board or select the ECP5UM-85F device.
3. From the Edit pull down menu select **Device Properties**. Set the Access mode to **SPI Flash Background Programming** and Operation to **SPI Flash Erase, Program, Verify**.

Figure 6. Device Information Dialog Screen

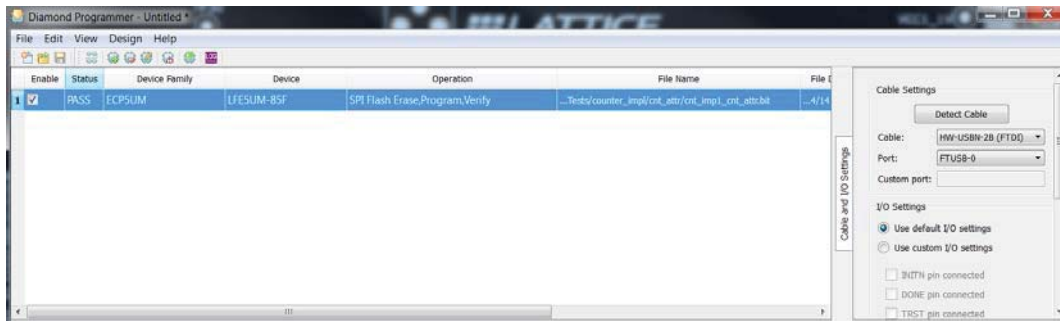

- Under the SPI Flash Options, select Family to **SPI Serial Flash**, Vendor to **Micron**, Device to **SPI-N25Q128A**, Package to **16-lead SOIC**.

Figure 7. Select Device Dialog Box

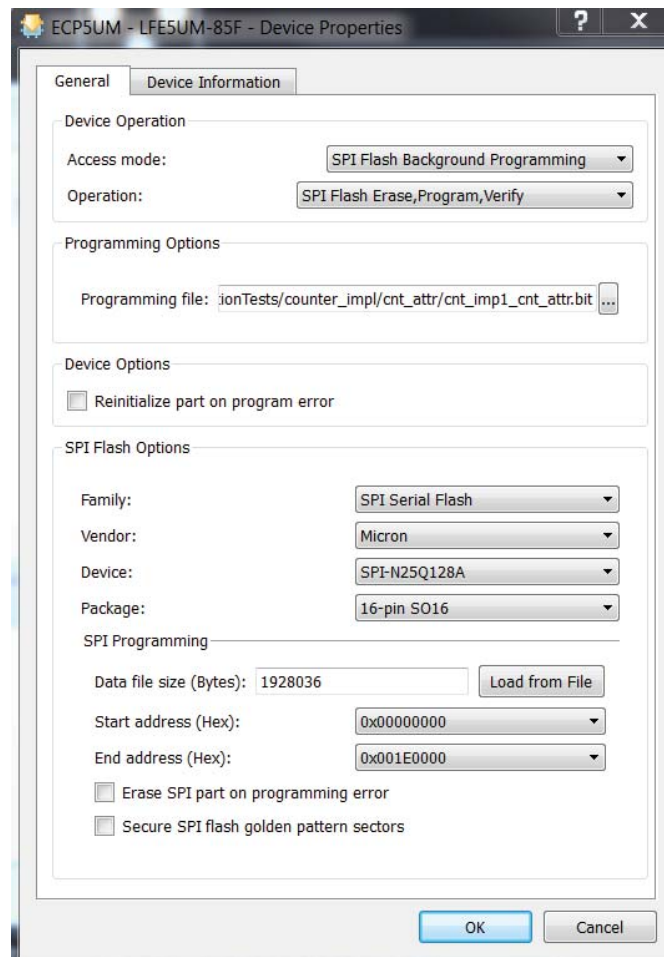

- Click **OK** in the Device Properties dialog box. You will return to the main configuration screen.
- Using SW6 set the ECP5 CFG pins to 010.
- From the main programming window, select **Go** from the top toolbar. This begins the SPI Serial Flash programming.

**On-Board Clock Capabilities** (See Appendix B, "Clock Generation" and "LPDDR3" sheets)

The ECP5 PCI Express Board allows for several clock source options. Some of these options are controlled via the ispClock5304 programmable clock manager device. The clock manager will be supplied by a 54 MHz clock on-board oscillator or an external clock source. The LPDDR3 clock will be supplied directly from a 100 MHz on board oscillator.

**Table 2. Clock Sources**

<b>Clock Destination</b>	<b>Clock Sources</b>	<b>Control Switch Setting</b>
ECP5 ball AD32 site LRC_GPLL0T_IN	54 MHz On board Oscillator X1	SW7[7]=0, ispClock5304 PLL can be used by setting SW7[8]=1
	External Clock J4	SW7[7]=1, ispClock5304 PLL can be used by setting SW7[8]=1
ECP5 ball A17 site ULC_GPLL0T_IN	54 MHz On board Oscillator X1	SW7[7]=0, ispClock5304 PLL can be used by setting SW7[8]=1
	External Clock J4	SW7[7]=1, ispClock5304 PLL can be used by setting SW7[8]=1
ECP5 ball C5/D5 site ULC	100 MHz On board Oscillator U32	
Connector CN1 (Left)	54 MHz On board Oscillator X1	ispClock5304 PLL can be used by setting SW7[8]=1
Connector CN2 (Right)	54 MHz On board Oscillator X1	ispClock5304 PLL can be used by setting SW7[8]=1

**SERDES**

The ECP5 based SERDES FPGA is utilized on the board for several purposes. The SERDES block is provisioned to provide a single, full-duplex PCI Express channel. The high-speed signals are connected to the PCI Express edge connection.

**FPGA Test Pins** (See Appendix B, "ECP5 Config" and "LEDs and Switches" sheets)

**General Purpose DIP Switches**

General purpose FPGA pins are available for user applications. FPGA pins are connected to switch SW4, SW7 with a piano style DIP switch. The switches are connected to logic level 0 when Down, logic level 1 when Up. Switch position 1 is indicated with a dot. Switch SW4 logic 1 is 2.5V. Switch SW4 logic 1 is 2.5V. The user must program these inputs to be the LVC MOS25 or LVC MOS33 type in the design.

**Figure 8. ECP5 PCI Express Board LEDs and Switches**

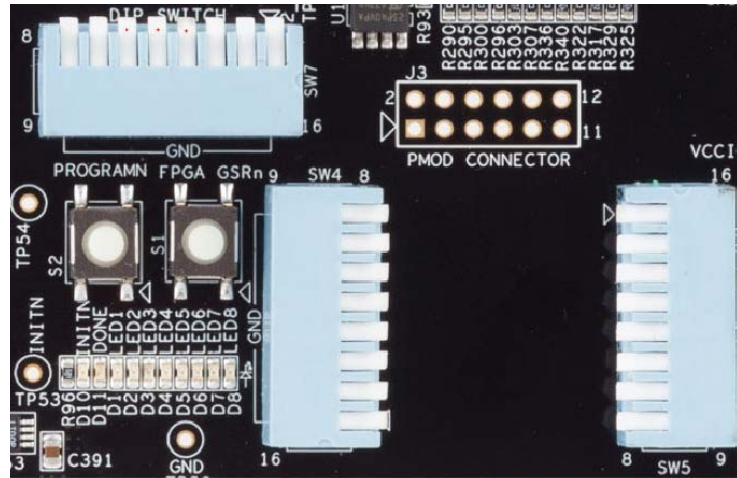

The designated pins are connected according to Table 5.

**Table 3. FPGA Ball to DIP Switch Position**

FPGA Ball Number	SW4 DIP Switch Position
AK31	1
AM31	2
AJ31	3
AL32	4
AG28	5
AJ28	6
AG29	7
AH28	8

FPGA Ball Number	SW7 DIP Switch
Position	
F31	4
F32	5
E32	6



**General Purpose LEDs** (See Appendix B, "LEDs and Switches" sheet)

The LEDs provided on the ECP5 PCI Express Board are connected to general purpose FPGA I/Os. These LEDs provide status for user designs and must be included in the design. The LEDs illuminate when the FPGA output is driven LOW. Table 6 shows the LED and associated FPGA pins. These pins are within an I/O bank connected to 2.5 V and the user should program these to be LVCMOS25 type outputs in the design.

**Table 4. LED Definitions**

LED Number	FPGA Ball Number	PCB Designator	LED Color
LED1	AM28	D1	Red
LED2	AL28	D2	Red
LED3	AM29	D3	Red
LED4	AK28	D4	Red
LED5	AK32	D5	Red
LED6	AM30	D6	Red
LED7	AJ32	D7	Red
LED8	AL30	D8	Red

**LPDDR3 Memory Device** (See Appendix B, "LPDDR" sheet)

- The ECP5 PCI Express Board is equipped with a LPDDR3 memory device (1.2 V, 64 Mb/x32, 96-ball FBGA, 1600 MHz) such as the Micron EDF8132A1MC device.
- The LPDDR3 memory is limited to a 16-bit wide memory controller interface.
- A 100-MHz on-board clock oscillator is available to provide a LPDDR3 reference clock.

**Table 5. DDR3 Memory Controller Interconnections**

NETNAME	484 fpBGA Ball Number	NETNAME	484 fpBGA Ball Number
DQ0	AD3	CE0	U7
DQ1	Y1	CE1	U4
DQ2	AE3	CLKP	R6
DQ3	AC5	CLKN	T6
DQ4	AB4	CA0	R3
DQ5	W2	CA1	R1
DQ6	AE2	CA2	U2
DQ7	AD4	CA3	N1
DQ8	AC6	CA4	Y3
DQ9	AB7	CA5	P3
DQ10	Y6	CA6	P2
DQ11	Y5	CA7	T2
DQ12	AD7	CA8	U3
DQ13	W5	CA9	P1
DQ14	W4	ODT	V6
DQ15	Y4	CS0#	U6
DQS0	AC3	CS1#	V7
DQS0#	AB2	VREF	V4
DQS1	AB5	DM0	AB3
DQS1#	AB6	DM1	Y7

**Ethernet Interfaces** (See Appendix B, "RJ45" sheet)

One Marvell 88E1512 Gigabit Ethernet transceiver device (U11) is included on the board. This physical layer device supports 1000BASE-T, 100BASE-TX, and 10BASE-T applications via a standard media interface to a RJ45 connection. The RJ45 connection includes network magnetics providing the proper signal conditioning, electro-magnetic interference suppression and signal isolation. This connector includes two LEDs and the board includes four status LEDs from the Marvell device. The LEDs are register-programmed and detailed descriptions are available in the Marvell device data sheet.

**Table 6. PHY Status Indicators**

LED	Status Description
RJ45 (Yellow)	LED RX
RJ45 (Yellow)	LED TX

The Marvell 88E1512 device communicates via a RGMII interface to the ECP5 device.

**Table 7. FPGA GPIO to RGMII Interfaces**

Signal	PHY
RxClk	A18
RxCtrl	AC28
RxD0	A19
RxD1	F18
RxD2	D18
RxD3	B19
TxCclk	A2
TxCtrl	AD29
TxD0	A5
TxD1	A4
TxD2	A3
TxD3	D7
Mdc	AE30
Mdio	AD30
CLK125	B29(URC_GPLL1T_IN)
CLK125	C17 (PCLKT0_0)
Resetn	AC31
Config	AE31

## Power Measurements *(See Appendix B, "ECP5 Power" sheet)*

The ECP5 PCI Express Board allows for easy power measurements with a multi-meter of the ECP5 device. The ECP5 power rails are isolated and can be measured by measuring the voltage across power resistors.

**Figure 9. ECP5 Power Measurements**

Voltage Rail	Test Points	Power Resistor Value (Ohms)
VCCAUX	TP19, TP18	0.1
VCC	TP13, TP12	0.01
VCCIO3_3 (Bank 8)	TP5, TP4	0.1
VCCIO2_5 (Bank 0, 1, 3, 4, 7)	TP16, TP17	0.1
VCCIO1_5 (Bank 2)	TP14, TP11	0.1
VCCIO1_2 (Bank 6)	TP36, TP37	0.1
VCCA	TP21, TP20	0.01
SERDES	TP22, TP24	0.1

## PMOD *(See Appendix B, "ECP5 Config" sheet)*

The ECP5 connects to a PMOD connector J3. To isolate the PVMOD connector from the FTDI device set all SW5 switches to 1 (Up=1).

**Figure 10. PMOD Connector and Switches**

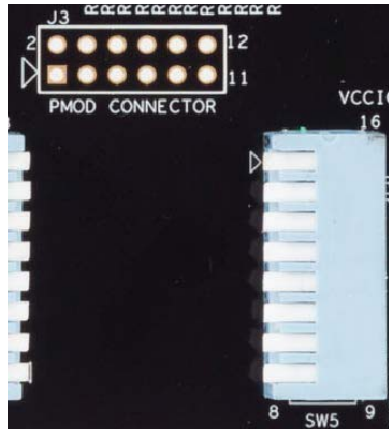

## Expansion Headers/Connectors *(See Appendix B, "Card #1" and "Card #2" sheets)*

**Table 8. Expansion Connections**

CN1/J1 (Left) Expansion Connector		
Pin	Signal	ECP5 Ball
1	2.5 V	2.5 V
2	2.5 V	2.5 V
3	Lvcmos1_2	D16
4	Lvcmos1_0	A16
5	Lvcmos1_3	E16
6	Lvcmos1C_1	B16
7	Lvcmos1_6	C15
8	Lvcmos1_4	A15

CN2/J2 (Left) Expansion Connector		
Pin	Signal	ECP5 Ball
1	2.5 V	2.5 V
2	2.5 V	2.5 V
3	Lvcmos2_2	C19
4	Lvcmos2_0	F17
5	Lvcmos2_3	E19
6	Lvcmos2C_1	E17
7	Lvcmos2_6	A20
8	Lvcmos2_4	D19

<b>CN1/J1 (Left) Expansion Connector</b>		
<b>Pin</b>	<b>Signal</b>	<b>ECP5 Ball</b>
9	Lvcmos1_7	D15
10	Lvcmos1_5	F16
11	Lvcmos1_10	B14
12	Lvcmos1_8	A14
13	Lvcmos1_11	C14
14	Lvcmos1_9	F15
15	Lvcmos1_14	F14
16	Lvcmos1_12	E14
17	Lvcmos1_15	A13
18	Lvcmos1_13	D14
19	Lvcmos1_18	F13
20	Lvcmos1_16	D13
21	Lvcmos1_19	A11
22	Lvcmos1_17	C13
23	Lvcmos1_22	D11
24	Lvcmos1_20	C11
25	Lvcmos1_23	E11
26	Lvcmos1_21	B11
27	Lvcmos1_26	B10
28	Lvcmos1_24	A10
29	Lvcmos1_27	C10
30	Lvcmos1_25	F11
31	Lvcmos1_30	A9
32	Lvcmos1_28	E10
33	Lvcmos1_31	A9
34	Lvcmos1_29	D10
35	Lvcmos1_34	F9
36	Lvcmos1_32	D9
37	Lvcmos1_35	A8
38	Lvcmos1_33	C9
39	Lvcmos1_38	D8
40	Lvcmos1_36	C8
41	Lvcmos1_39	E8
42	Lvcmos1_37	B8
43	GND	GND
44	GND	GND

<b>CN2/J2 (Left) Expansion Connector</b>		
<b>Pin</b>	<b>Signal</b>	<b>ECP5 Ball</b>
9	Lvcmos2_7	D20
10	Lvcmos2_5	F19
11	Lvcmos2_10	A22
12	Lvcmos2_8	C20
13	Lvcmos2_11	C22
14	Lvcmos2_9	F20
15	Lvcmos2_14	E22
16	Lvcmos2_12	B22
17	Lvcmos2_15	A23
18	Lvcmos2_13	D22
19	Lvcmos2_18	C23
20	Lvcmos2_16	F22
21	Lvcmos2_19	E23
22	Lvcmos2_17	B23
23	Lvcmos2_22	A24
24	Lvcmos2_20	D23
25	Lvcmos2_23	D24
26	Lvcmos2_21	F23
27	Lvcmos2_26	A25
28	Lvcmos2_24	C24
29	Lvcmos2_27	C25
30	Lvcmos2_25	F24
31	Lvcmos2_30	D25
32	Lvcmos2_28	B25
33	Lvcmos2_31	A26
34	Lvcmos2_29	D25
35	Lvcmos2_34	C26
36	Lvcmos2_32	F25
37	Lvcmos2_35	A28
38	Lvcmos2_33	B26
39	Lvcmos2_38	A30
40	Lvcmos2_36	D26
41	Lvcmos2_39	A31
42	Lvcmos2_37	A29
43	GND	GND
44	GND	GND

## Ordering Information

Description	Ordering Part Number	China RoHS Environment-Friendly Use Period (EFUP)
ECP5 PCI Express Board	LFE5UM-85F-PB-EVN	

## Technical Support Assistance

e-mail: [techsupport@latticesemi.com](mailto:techsupport@latticesemi.com)

Internet: [www.latticesemi.com](http://www.latticesemi.com)

## Revision History

Date	Version	Change Summary
April 2014	01.0	Initial release.

© 2014 Lattice Semiconductor Corp. All Lattice trademarks, registered trademarks, patents, and disclaimers are as listed at [www.latticesemi.com/legal](http://www.latticesemi.com/legal). All other brand or product names are trademarks or registered trademarks of their respective holders. The specifications and information herein are subject to change without notice.

## Appendix A. Bill of Materials

PROJECT NAME: ECP5 PCI EXPRESS BOARD

PAC NO: 305-PD-14-0XXX

CUSTOMER NAME: LATTICE

DATE: 07-17-2014 REV:B

Item	Reference	Qty	Part	PCB Footprint	Comments	PART_NUMBER	Manufacturer	Description
1	CN1	1	Card 1	PCIe_EDGE_FINGER		-	-	-
2	CN2	1	Card 2	PCIe_EDGE_FINGER		-	-	-
3	CN3	1	PCI Express x4 Edge Finger Conn.	4X30X2MM	PCI Express x4 Edge Finger	-	-	-
4	C5,C17,C141,C147,C148,C159,C160,C195,C198,C199,C201,C204,C214,C223,C224,C226,C230	17	0.1uF	C0603	-	C1608X7R1E104K080AA	TDK Corporation	CAP CER .10UF 25V X7R 10% 0603
5	C6	1	0.01uF	C0603	-	C0603C103K5RACTU	Kemet	CAP CAP CER 10000PF 50V 10% X7R 0603
6	C9,C55,C56,C65,C78	5	330pF	C0402	-	C1005C0G1H331J050BA	TDK Corporation	CAP CER 330PF 50V 5% NP0 0402
7	C40,C41	2	18pF	C0603	-	C1608C0G1H180J080AA	TDK Corporation	CAP CER 18PF 50V C0G 5% 0603
8	C46,C69,C87,C97	4	10uF	C1206	-	C3216Y5V1E106Z	TDK Corporation	CAP CER 10UF 25V Y5V 1206
9	C47,C48,C62,C74,C219	5	220nF	C0402	-	C1005X7R1C224K050BC	TDK Corporation	CAP CER 0.22UF 16V 10% X7R 0402
10	C49,C50,C61,C79	4	1nF	C0402	-	C1005C0G1E102J050BA	TDK Corporation	CAP CER 1000PF 25V 5% NP0 0402
11	C51,C52	2	100pF	C0603	-	C1608C0G1H101J080AA	TDK Corporation	CAP CER 100PF 50V 5% NP0 0603
12	C53,C54	2	10pF	C0402	DNI	C1005C0G1H100D050BA	TDK Corporation	CAP CER 10PF 50V NP0 0402
13	C58,C66,C75,C82,C90,C174,C175,C177,C181,C326,C374,C391	12	1uF	C0805	-	C2012X5R1C105K085AA	TDK Corporation	CAP CER 1UF 16V 10% X5R 0805
14	C59,C67,C76,C81,C172,C173,C176,C240,C325,C386	10	22uF_T	C0805-T	-	F951A226MPAAQ2	AVX	CAP TANT 22UF 10V 20% 0805
15	C60,C68,C70,C80,C94,C185,C186,C187,C196,C200,C205,C208,C209,C210,C211,C217,C218,C220,C225,C227,C233,C234,C237,C238,C239,C243,C256,C257,C275,C276,C277,C278,C280,C281,C282,C285,C291,C292,C300,C303,C305,C306,C307,C311,C317,C319,C322,C323,C328,C330,C331,C332,C334,C335,C336,C337,C338,C339,C340,C341,C342,C343,C344,C346,C347,C349,C350,C351,C352,C353,C354,C355,C356,C357,C359,C360,C362,C363,C388	79	0.1uF	C0402	-	C1005X7R1C104K050BC	TDK Corporation	CAP CER 0.1UF 16V 10% X7R 0402
16	C64,C77	2	10pF	C0402	-	C1005C0G1H100D050BA	TDK Corporation	CAP CER 10PF 50V NP0 0402
17	C71	1	10uF_T	C0805-T	-	TPSR106K006R1500	AVX	CAP TANT 10UF 6.3V 10% 0805
18	C88,C95	2	3.3uF	C0805	-	ECJ-2FB1A335K	Panasonic - ECG	CAP CER 3.3UF 10V 10% X5R 0805

Item	Reference	Qty	Part	PCB Footprint	Comments	PART_NUMBER	Manufacturer	Description
19	C89,C91,C96,C188,C189,C190,C202,C231,C235,C236,C279,C294,C295,C296,C297,C298,C301,C302,C304,C308,C309,C310,C318,C327,C329,C345,C348,C358,C361,C364,C365,C366,C367,C368,C369,C370,C371,C372,C373,C375,C376,C377,C378,C379,C380,C381,C382,C383,C384,C385,C401,C402,C403,C404,C405	55	0.01uF	C0402	-	ECJ-0EB1E103K	Panasonic - ECG	CAP .01UF 25V CERAMIC X7R 0402
20	C178,C213	2	4.7uF	C0603	-	C1608X5R0J475K080AB	TDK Corporation	CAP CER 4.7UF 6.3V X5R 0603
21	C179,C180,C182,C191,C192,C194,C197,C241,C242,C244,C245,C246,C247	13	0.01uF	C0402_DDR3	-	ECJ-0EB1E103K	Panasonic - ECG	CAP .01UF 25V CERAMIC X7R 0402
22	C183,C184,C206,C207,C212,C215,C216,C248,C249,C250,C251,C252,C253	13	0.1uF	C0402_DDR3	-	C1005X7R1C104K050BC	TDK Corporation	CAP CER 0.1UF 16V 10% X7R 0402
23	C193,C203,C228,C258,C260,C261,C262,C263,C392	9	10uF	C0805	-	08056C106KAT2A	AVX Corporation	CAP CER 10UF 6.3V 10% X7R 0805
24	C221,C222	2	27pF	C0603	-	C0603C270J5GACTU	Kemet	CAP CER 27PF 50V 5% NP0 0603
25	C229	1	3.3uF	C0603	-	C1608X5R0J335K080AB	TDK Corporation	CAP CER 3.3UF 6.3V X5R 0603
26	C232	1	10nF	C0603	-	ECJ-1VB1C103K	Panasonic ECG	CAP CER 10000PF 16V 10% X7R 0603
27	C264	1	4.7uF	C0805	-	GRM21BR60J475KA11L	Murata Electronics North America	CAP CER 4.7UF 6.3V 10% X5R 0805
28	C270,C271,C283,C299,C313,C314,C315,C333,C389,C390	10	22uF	C0805	-	C2012X5R0J226M125AC	TDK Corporation	CAP CER 22UF 6.3V 20% X5R 0805
29	C393,C394,C395,C396,C397,C398,C399,C400	8	0.1uF	C0402	-	C1005X7R1C104K050BC	TDK Corporation	CAP CER 0.1UF 16V 10% X7R 0402
30	C406,C408	2	20pF	C0402	DNL	C0402C200J5GACTU	Kemet	CAP CER 20PF 50V 5% NP0 0402
31	C407	1	20pF	C0402	-	C0402C200J5GACTU	Kemet	CAP CER 20PF 50V 5% NP0 0402
32	D1,D2,D3,D4,D5,D6,D7,D8,D10,D12	10	Red	D0603	-	LTST-C190KRKT	Lite-On Inc	LED SUPER RED CLEAR 0603 SMD
33	D11,D13,D17,D20,D25,D26,D27	7	Green	D0603	-	APT1608SGC	Kingbright Company LLC	LED 1.6X0.8MM 568NM GREEN CLR SMD
34	D14,D15,D21,D23	4	DFLS220L	DFLS220L	-	DFLS220L-7	Diodes Inc	DIODE SCHOTTKY 20V 2A POWERDI123
35	D16,D18,D19,D24	4	1N4448W	1N4448W	-	1N4448WT	Fairchild Semiconductor	DIODE SWITCHING 75V 0.2A SOD523F
36	D22	1	SCHOTTKY/VISHAY-V12P10	V12P10	-	V12P10-M3/86A	Vishay Semiconductor Diodes Division	DIODE SCHOTTKY 100V 12A TO277A
37	FB2,FB16,FB17,FB18	4	74279265	74279265	-	74279265	Würth Electronics Inc	FERRITE BEAD 600 OHM .2A 0603
38	FB4,FB13,FB14,FB15,FB19,FB22,FB23,FB25,FB26	9	BLM41PG600SN1	FB1806	-	BLM41PG600SN1L	Murata Electronics North America	FERRITE CHIP 60 OHM 6000MA 1806
39	F1	1	F1251CT-ND	154010	-	0154010.DR	Littelfuse Inc	FUSE FAST 125VAC, 125VDC 10A SMD
40	G4	1	Lattice Logo	LOGO300_1000	DNL	-	-	-
41	G5	1	E-Friendly	EFRIENDLY_400_SM	DNL	-	-	-
42	G6	1	WEEE	WEEE_SM	DNL	-	-	-
43	J1,J2	2	HEADER 22X2	HEADER_22X2	DNI	TBD	FCI	CONN HEADER 44POS .100 STR 30AU
44	J3	1	HEADER 6X2	HEADER_6X2	DNI	67997-112HLF	FCI	CONN HEADER 12POS .100 STR 30AU
45	J4	1	SMA	73391-0060	DNI	733910060	Molex Inc	CONN SMA JACK STR 50 OHM PCB
46	J5	1	USB_MINI_B	TYPE_B	-	UX60-MB-5ST	Hirose	USBType-BMiniConnector
47	J11	1	PJ-002A	PJ-002A	-	PJ-002A	CUI Inc	CONN POWER JACK 2.1MM
48	J37	1	L829-1J1T-43	L829-1J1T-43	-	L829-1J1T-43	Bel Fuse Inc	CONN MAGJACK 1PORT 1000 BASE-T

Item	Reference	Qty	Part	PCB Footprint	Comments	PART_NUMBER	Manufacturer	Description
49	L1,L2,L3,L4	4	4.7uH-CDRH5D	CDRH5D	CUSTOMER SUP-PLIED	CDRH5D28RHPN P-4R7NC	Sumida	INDUCTOR 4.7UH 25% SMD
50	L5	1	600ohm 500mA	FB0603	-	BLM18AG601SN1D	Murata Electronics North America	FERRITE CHIP 600 OHM 500MA 0603
51	Q7,Q8,Q9,Q10	4	2N2222	SM_SOT23-3	-	MMBT2222A-7-F	Diodes Inc	TRANS NPN 40V 350MW SMD SOT23-3
52	R11,R12,R30,R47,R52,R67,R68,R70,R84,R86,R90,R100,R124,R127,R212,R213,R214,R215,R216,R217,R218,R219,R223,R224,R225,R226,R227,R228,R229,R234,R238,R251,R254,R263,R266,R270,R279,R283,R303,R317,R319,R325,R330,R331,R332,R333,R340	47	4.7k	R0603	-	ERJ-3EKF4701V	Panasonic - ECG	RES 4.70K OHM 1/10W 1% 0603 SMD
53	R126	1	20	R0603	-	RC0603FR-0720RL	Yageo	RES 20.0 OHM 1/10W 1% 0603 SMD
54	R18,R43,R44,R45,R46,R48,R49,R50,R51,R64,R69,R71,R72,R73,R75,R76,R78,R82,R91,R92,R93,R94,R97,R104,R110,R111,R120,R123,R125,R129,R175,R183,R209,R210,R289,R290,R293,R295,R296,R300,R307,R310,R312,R314,R321,R322,R323,R326,R329,R336,R420,R421,R422,R423	54	0	R0603	-	ERJ-3GEY0R00V	Panasonic ECG	Resistor 0.0 SMD 0603
55	R19,R20,R378,R385,R386,R393,R394,R400,R401,R407,R409,R414	12	50	R0603	-	ERJ-3EKF49R9V	Panasonic Electronic Components	RES 49.9 OHM 1/10W 1% 0603 SMD
56	R36,R113,R116,R143,R166,R182	6	0.1	R2010	-	WSL2010R1000F EA	Vishay Dale	RES .10 OHM 1/2W 1% 2010 SMD
57	R40,R41,R65,R66,R77,R79,R83,R95,R99,R101,R107,R117,R122,R128,R131,R135,R138,R142,R145,R152,R157,R160,R162,R172,R174,R178,R180,R298,R301,R304,R308,R309,R311,R313,R315,R316,R320,R327,R328,R334,R335,R337,R338,R339,R341,R342,R345,R349,R352,R356,R372,R375,R377,R380,R383,R388,R392,R396,R398,R402,R405,R427,R428,R429,R430,R431,R432,R433,R434,R435,R436,R437,R438,R439,R440,R441,R442	77	0	R0402	-	ERJ-2GE0R00X	Panasonic ECG	RES 0.0 OHM 1/10W 0402 SMD
58	R60,R62,R80,R85,R102,R177,R181	7	0	R0603	DNI	ERJ-3GEY0R00V	Panasonic ECG	Resistor 0.0 SMD 0603
59	R61,R63,R274	3	4.7k	R0402	-	ERJ-2RKF4701X	Panasonic - ECG	RES 4.70K OHM 1/10W 1% 0402 SMD
60	R74	1	20	R0402	-	CRCW040220R0FKED	Vishay Dale	RES 20.0 OHM 1/16W 1% 0402 SMD
61	R81,R278	2	4.7k	R0603	DNI	ERJ-3EKF4701V	Panasonic - ECG	RES 4.70K OHM 1/10W 1% 0603 SMD
62	R87	1	4.7k	R0402	DNI	ERJ-2RKF4701X	Panasonic - ECG	RES 4.70K OHM 1/10W 1% 0402 SMD
63	R96	1	680	R0603	-	ERJ-3EKF6800V	Panasonic Electronic Components	RES 680 OHM 1/10W 1% 0603 SMD
64	R98,R105,R119,R130,R136,R144,R153,R161,R173,R179,R299,R302,R318,R343,R350,R371,R376,R381,R390,R397,R404	21	0	R0402	DNI	ERJ-2GE0R00X	Panasonic ECG	RES 0.0 OHM 1/10W 0402 SMD



Item	Reference	Qty	Part	PCB Footprint	Comments	PART_NUMBER	Manufacturer	Description
65	R106,R416, R417	3	220	R0603	-	ERJ-3EKF2200V	Panasonic ECG	RES 220 OHM 1/10W 1% 0603 SMD
66	R108,R190,R191, R192,R193,R194, R195,R196,R197	9	470	R0603	-	ERJ-3EKF4700V	Panasonic ECG	RES470OHM1/10W1%
67	R109,R88	2	1k	R0603	-	CRCW06031K00F KEA	Vishay/Dale	Resistor 1k SMD 0603
68	R112,R288	2	2.2k	R0603	-	ERJ-3GEYJ222V	Panasonic - ECG	RES 2.2K OHM 1/10W 5% 0603 SMD
69	R114,R115,R121, R148,R154,R221, R222,R281,R282, R305,R347,R384, R419	13	10K	R0603	-	CRCW060310K0F KEA	Vishay Dale	RES 10.0K OHM 1/10W 1% 0603 SMD
70	R118,R176	2	0.01	R2512	-	WSL2512R0100F EA18	Vishay Dale	RES .01 OHM 2W 1% 2512 SMD
71	R146	1	5.76K	R0603	-	ERJ-3EKF5761V	Panasonic Electronic Components	RES 5.76K OHM 1/10W 1% 0603 SMD
72	R147,R294	2	4.99k	R0603	-	ERJ-3EKF4991V	Panasonic Electronic Components	RES 4.99K OHM 1/10W 1% 0603 SMD
73	R149	1	3.83K	R0603	-	RC0603FR- 073K83L	Yageo	RES 3.83K OHM 1/10W 1% 0603 SMD
74	R151	1	63.4K	R0603	-	ERJ-3EKF6342V	Panasonic Electronic Components	RES 63.4K OHM 1/10W 1% 0603 SMD
75	R155	1	21.5K	R0603	-	ERJ-3EKF2152V	Panasonic Electronic Components	RES 21.5K OHM 1/10W 1% 0603 SMD
76	R156	1	30.1K	R0603	-	ERJ-3EKF3012V	Panasonic Electronic Components	RES 30.1K OHM 1/10W 1% 0603 SMD
77	R158	1	20K	R0603	-	ERJ-3EKF2002V	Panasonic Electronic Components	RES 20K OHM 1/10W 1% 0603 SMD
78	R159,R164,R169, R208	4	51K	R0603	-	ERJ-3EKF5102V	Panasonic Electronic Components	RES 51K OHM 1/10W 1% 0603 SMD
79	R163	1	34K	R0603	-	ERJ-3EKF3402V	Panasonic Electronic Components	RES 34K OHM 1/10W 1% 0603 SMD
80	R170	1	11.5K	R0603	-	ERJ-3EKF1152V	Panasonic Electronic Components	RES 11.5K OHM 1/10W 1% 0603 SMD
81	R171	1	35.7K	R0603	-	ERJ-3EKF3572V	Panasonic Electronic Components	RES 35.7K OHM 1/10W 1% 0603 SMD
82	R184	1	110K	R0603	-	RC0603FR- 07110KL	Yageo	RES 110K OHM 1/10W 1% 0603 SMD
83	R204,R205,R206, R207,R211,R344	6	100	R0402	DNI	ERJ-2RKF1000X	Panasonic Electronic Components	RES 100 OHM 1/10W 1% 0402 SMD
84	R220,R280	2	100k	R0603	-	ERJ-3GEYJ104V	Panasonic - ECG	RES 100K OHM 1/10W 5% 0603 SMD
85	R273	1	240	R0603	-	ERJ-3EKF2400V	Panasonic Electronic Components	RES 240 OHM 1/10W 1% 0603 SMD
86	R277,R306,R415	3	100	R0402	-	ERA-2AEB101X	Panasonic - ECG	RES 100 OHM 1/16W .1% 0402 SMD
87	R286,R287,R291, R292	4	50	R0402	-	ERJ-2RKF49R9X	Panasonic Electronic Components	RES 49.9 OHM 1/10W 1% 0402 SMD
88	R297	1	12k	R0603	-	ERA-3AEB123V	Panasonic - ECG	RES 12K OHM 1/10W .1% 0603 SMD
89	R324,R373,R389, R418	4	1.8K	R1206	-	ERJ-8ENF1801V	Panasonic Electronic Components	RES 1.8K OHM 1/4W 1% 1206 SMD
90	R379,R382,R387, R391,R395,R399, R403,R406,R412, R413	10	316	R0603	-	ERJ-3EKF3160V	Panasonic Electronic Components	RES 316 OHM 1/10W 1% 0603 SMD
91	R424,R425,R426, R443,R444,R445	6	1k	R0402	-	ERJ-2RKF1001X	Panasonic Electronic Components	RES 1K OHM 1/10W 1% 0402 SMD
92	SW4,SW5,SW7	3	SW DIP-8	CTS_208-8	-	194-8MST	CTS Corporation Electrocompo- nents	x8 DIP Switch Piano
93	SW6	1	SW DIP-4	CTS_204-4	-	195-4MST	CTS Electrocompo- nents	SWITCH SIDE ACTUATED 4 SEC
94	S1,S2	2	GlobalReset	SMT_SW	-	EVQ-Q2K03W	Panasonic - ECG	SWITCH LT 6MM 130GF H=3.1MM SMD
95	TH1,TH2,TH3, TH4,TH5	5	ThruHole	MTG125	DNI	-	-	-

Item	Reference	Qty	Part	PCB Footprint	Comments	PART_NUMBER	Manufacturer	Description
96	TP3,TP4,TP5,TP7,TP8,TP9,TP10,TP11,TP12,TP13,TP14,TP15,TP16,TP17,TP18,TP19,TP20,TP21,TP22,TP23,TP24,TP25,TP26,TP27,TP28,TP29,TP30,TP31,TP32,TP33,TP34,TP35,TP36,TP37,TP38,TP39,TP40,TP41,TP42,TP43,TP44,TP45,TP46,TP47,TP48,TP49,TP50,TP51,TP52,TP53,TP54,TP55,TP56,TP57,TP58,TP59,TP60,TP61,TP62	59	TestPoint	TP50	DNI	-	-	-
97	U1	1	LFE5M-85F-BG756	756fpBGA	CUSTOMER SUP-PLIED	ECP5 85 756 fpBGA	Lattice	ECP5
98	U4	1	ispCLOCK5304S	TQFP_48	CUSTOMER SUP-PLIED	ispPAC-CLK5304S-01T48C	Lattice	ispClock 5300S
99	U11	1	88E1512_56QFN	56-QFN	-	88E1512-XX-NNP2C000	Marvell	Ethernet Transceiver
100	U13	1	FT2232HL	tqfp64_0p5_12p2x12p2_h1p6	CUSTOMER SUP-PLIED	FT2232HL	Future	USB UART/FIFO
101	U14	1	LCMXO2-256/640-MG132	MG132	CUSTOMER SUP-PLIED	LCMXO2-640HC-4MG132C	Lattice	Lattice MachXO2
102	U15	1	M25P40-VMN3PB	SO8	CUSTOMER SUP-PLIED	M25P40-VMN3PB	Micron	4Mb, 2.5V, M25P40 Serial Flash Embedded Memory
103	U20,U21	2	LT3508EUF	LT3508EUF	CUSTOMER SUP-PLIED	LT3508EUF#PBF	Linear Technology	IC REG BUCK ADJ 1.4A DL 24QFN
104	U22	1	LT3029EDE	LT3209EDE	CUSTOMER SUP-PLIED	LT3029EDE#PBF	Linear Technology	IC REG LDO ADJ 0.5A 16DFN
105	U23,U24,U25,U26	4	R0_1-3	3PIN_0402	Populate pin 1-3	ERJ-2GE0R00X	Panasonic ECG	RES 0.0 OHM 1/10W 0402 SMD
106	U27,U28,U29,U30	4	R0_1-3	3PIN_0402P	Populate pin 1-3	ERJ-2GE0R00X	Panasonic ECG	RES 0.0 OHM 1/10W 0402 SMD
107	U32	1	SIT9120AC-2B1-25E100.000000	Diff_OSC_Sit9120AC	CUSTOMER SUP-PLIED	SIT9120AC-2B1-25E100.000000	SiTime	OSC 100.000 MHZ LVDS SMD 3.2x2.5
108	U33	1	M93C46-WMN6TP	SOIC-8	-	M93C46-WMN6TP	STMicroelectronics	IC 1K EEPROM 8-SOIC
109	U34,U35,U36,U37	4	R0_1-3	3PINTX_0402	Populate pin 1-3	ERJ-2GE0R00X	Panasonic ECG	RES 0.0 OHM 1/10W 0402 SMD
110	U38,U39,U40,U41	4	R0_1-3	3PINTX_0402P	Populate pin 1-3	ERJ-2GE0R00X	Panasonic ECG	RES 0.0 OHM 1/10W 0402 SMD
111	U42	1	R0_1-4	4PIN_0402_1	Populate pin 1-4	ERJ-2GE0R00X	Panasonic ECG	RES 0.0 OHM 1/10W 0402 SMD
112	U43	1	R0_1-4	4PIN_0402	Populate pin 1-4	ERJ-2GE0R00X	Panasonic ECG	RES 0.0 OHM 1/10W 0402 SMD
113	U44	1	R0_1-3	3PIN_0603	Populate pin 1-3	ERJ-3GEY0R00V	Panasonic ECG	Resistor 0.0 SMD 0603
114	U49	1	EDF8132A1MC-GD-F	178FBGA	CUSTOMER SUP-PLIED	EDF8132A1MC-GD-F	ELPIDA	8Gb DDR3 Mobile RAM, DDP
115	U50	1	TPSS51200DRCR	10-VDFDN	-	TPSS51200DRCT	Texas Instruments	IC REG SINK/SOURCE DDR 10-SON
116	U51	1	LT1761ES5-1.8	TSOT-23-5	CUSTOMER SUP-PLIED	LT1761ES5-1.8#TRMPBF	Linear Technology	IC REG LDO 1.8V 0.1A TSOT23-5
117	U52	1	N25QxxxA13xSF	SO16W	CUSTOMER SUP-PLIED	N25Q128A13ESF40G	Micron	128Mb, 3V, Multiple I/O Serial Flash Memory
118	U53	1	LT3085	8MSOP	CUSTOMER SUP-PLIED	LT3085EMS8E#PBF	Linear Technology	IC REG LDO ADJ 0.5A 8MSOP
119	X1	1	SIT1602AC-11-25E-54.000000	OSC_Sit1602AC	CUSTOMER SUP-PLIED	SIT1602AC-11-25E-54.000000	SiTime	OSC 54.000 MHZ CMOS SMD 2.5x2.0
120	X2	1	12 MHZ	crystal_4p_3p2x2p5	-	7M-12.000MAAJ-T	TXC CORPORATION	CRYSTAL 12.000 MHZ 18PF SMD
121	Y1	1	25 MHZ CRYSTAL	HC49US	-	HC49US-25.000MAJ-UB	Citizen Finetech Miyota	CRYSTAL 25.000MHZ 18PF THRU
122	ECP5 PCI EXPRESS BOARD PCB	1	-	-	-	305-PD-14-0XXX	PACTRON	-

**Appendix B. Schematic**

<h1>ECP5 PCI Express Board</h1> <h2>June 2014</h2> <h3>Revision: B</h3>		 Lattice Semiconductor Applications Email: techsupport@lattice.com	
Title		Cover Page	
Size	Project	Sheet	Schematic Rev. B
B	ECP5 PCI Express Board	1	Rev. 1.0
DATE:	NOV. 2012	Sheet	1 of 1

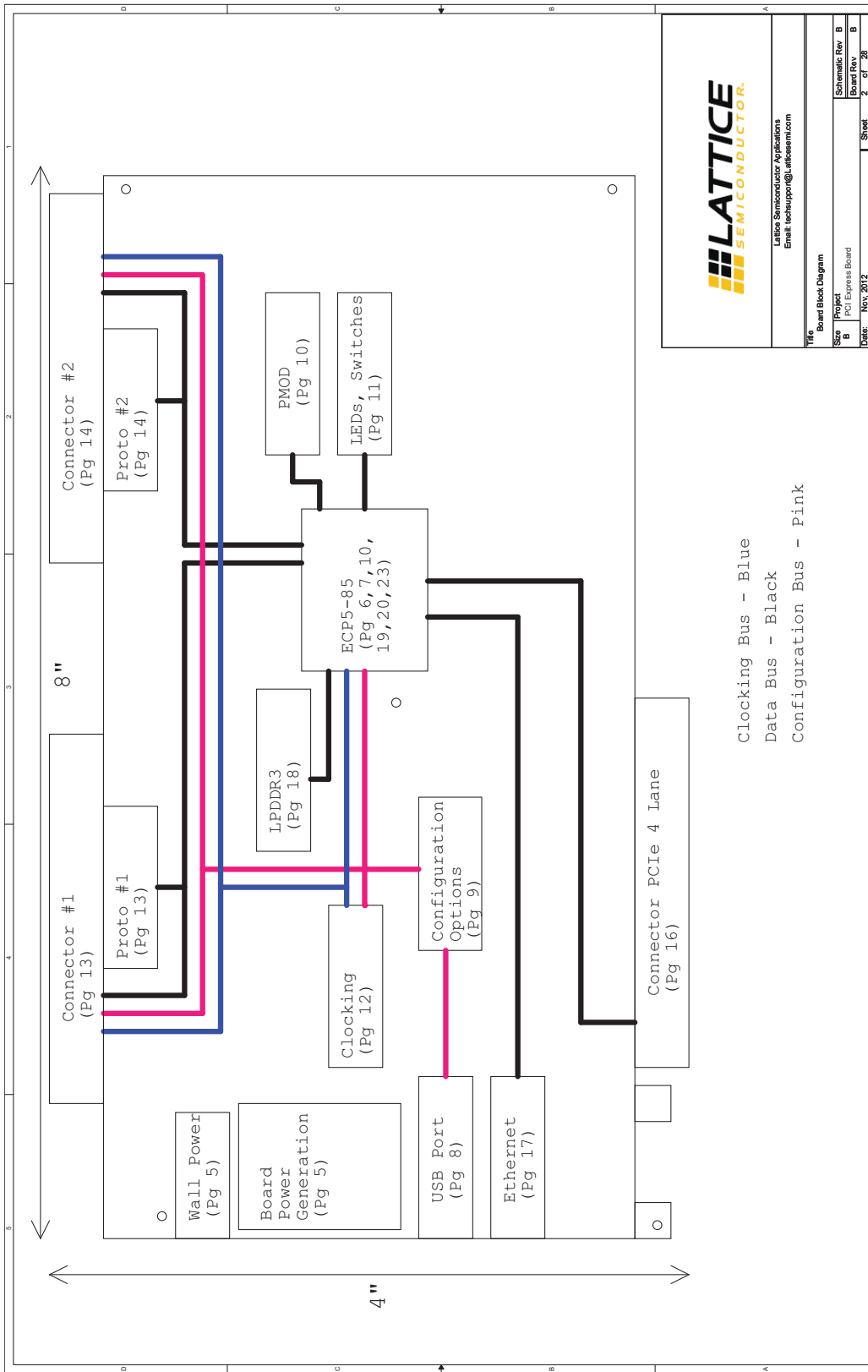

**LATTICE SEMICONDUCTOR.**

Lattice Semiconductor Applications  
Email: techsupport@lattice.com

Title	
Board Block Diagram	
Project	PCI Express Board
Size	Schematic Rev. B
Board Rev.	Board Rev. B
Date	Nov. 2012
Sheet	2 of 28

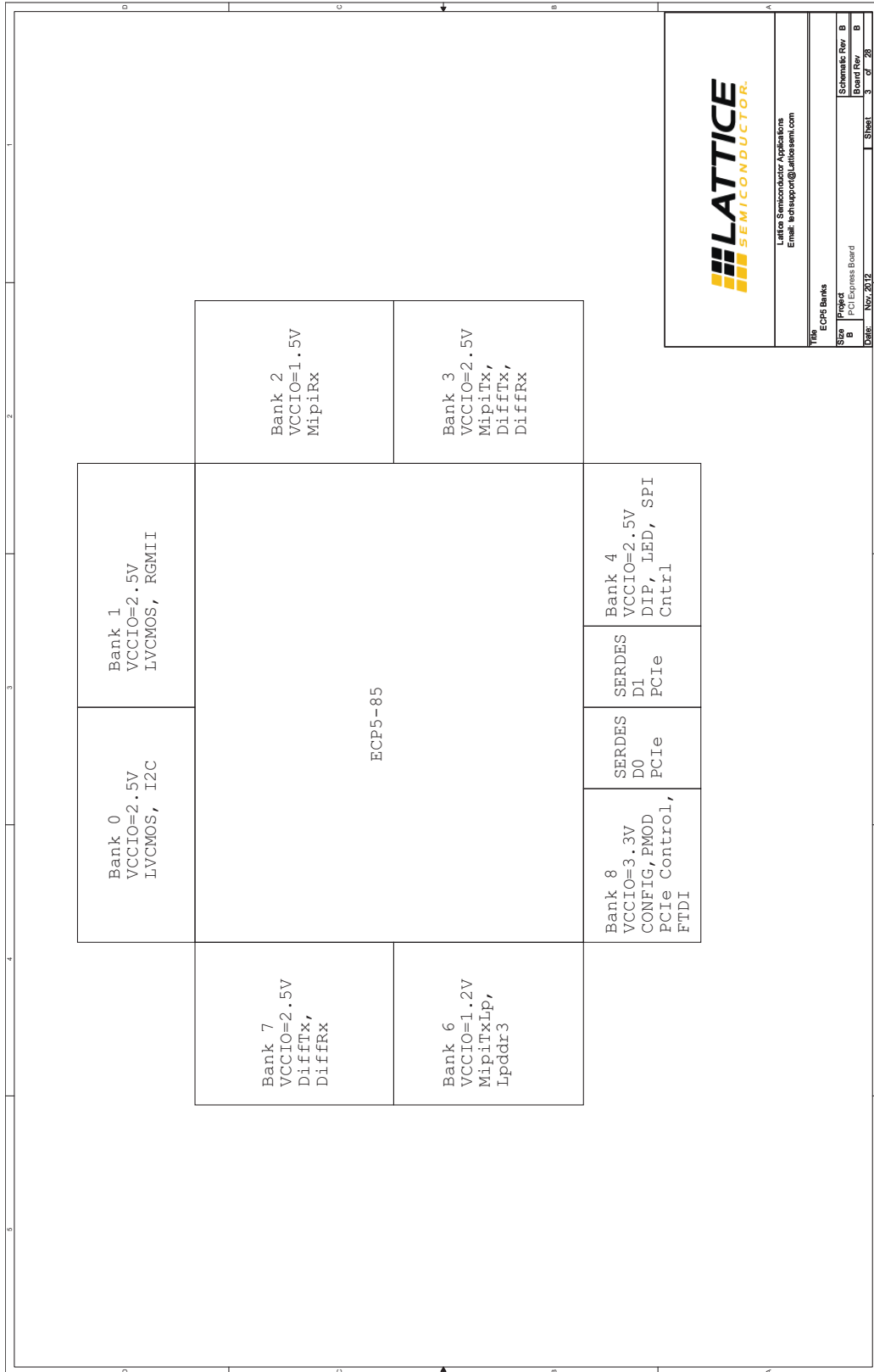

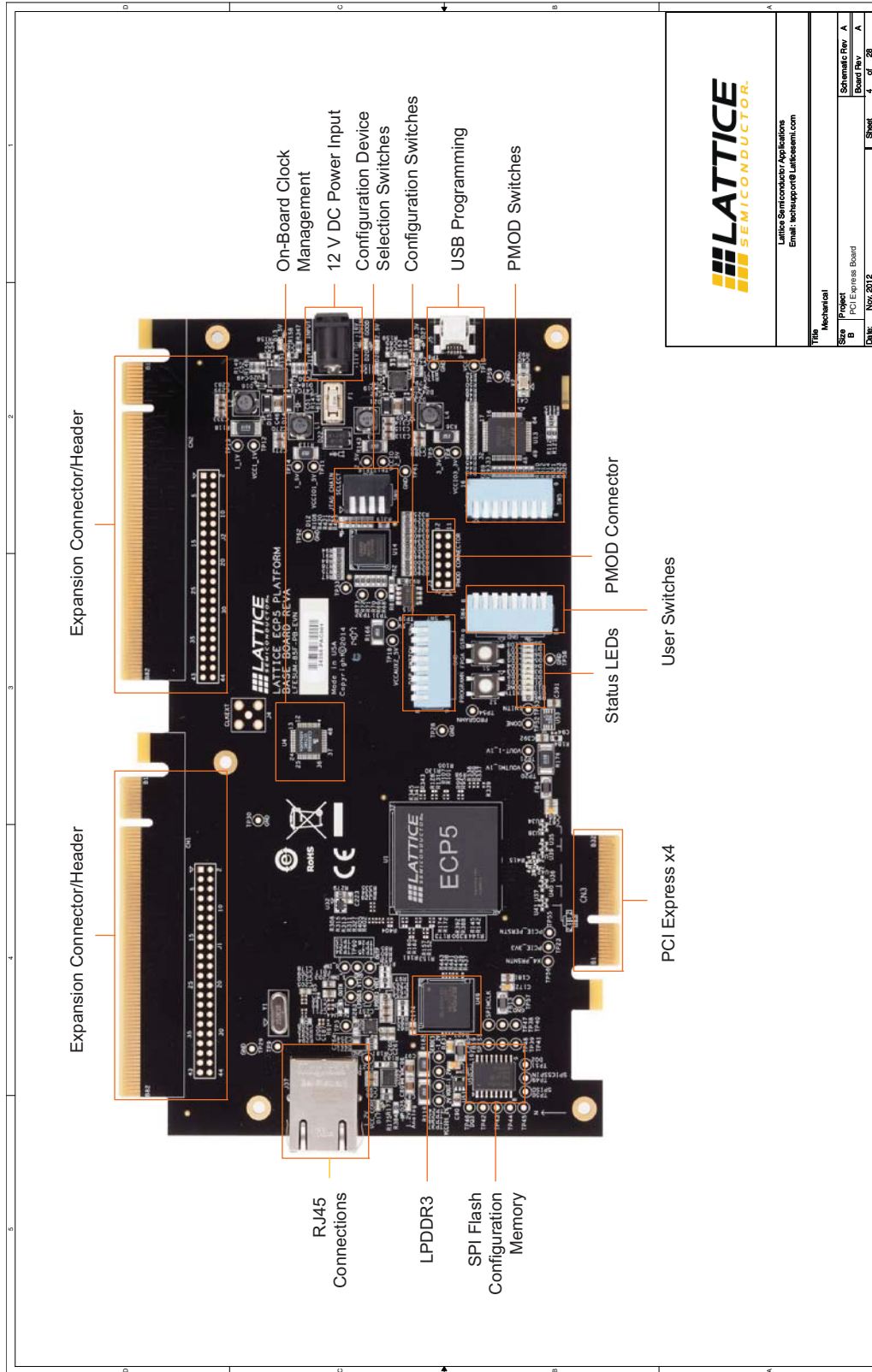

**LATTICE**  
SEMICONDUCTOR.

Lattice Semiconductor Applications  
Email: techsupport@lattice.com

TYPE	Mechanical
SIZE	Project
SIZE	B
DATE	Nov 2012
SCHEMATIC REV.	A
BOARD REV.	A
SHEET	4 of 28

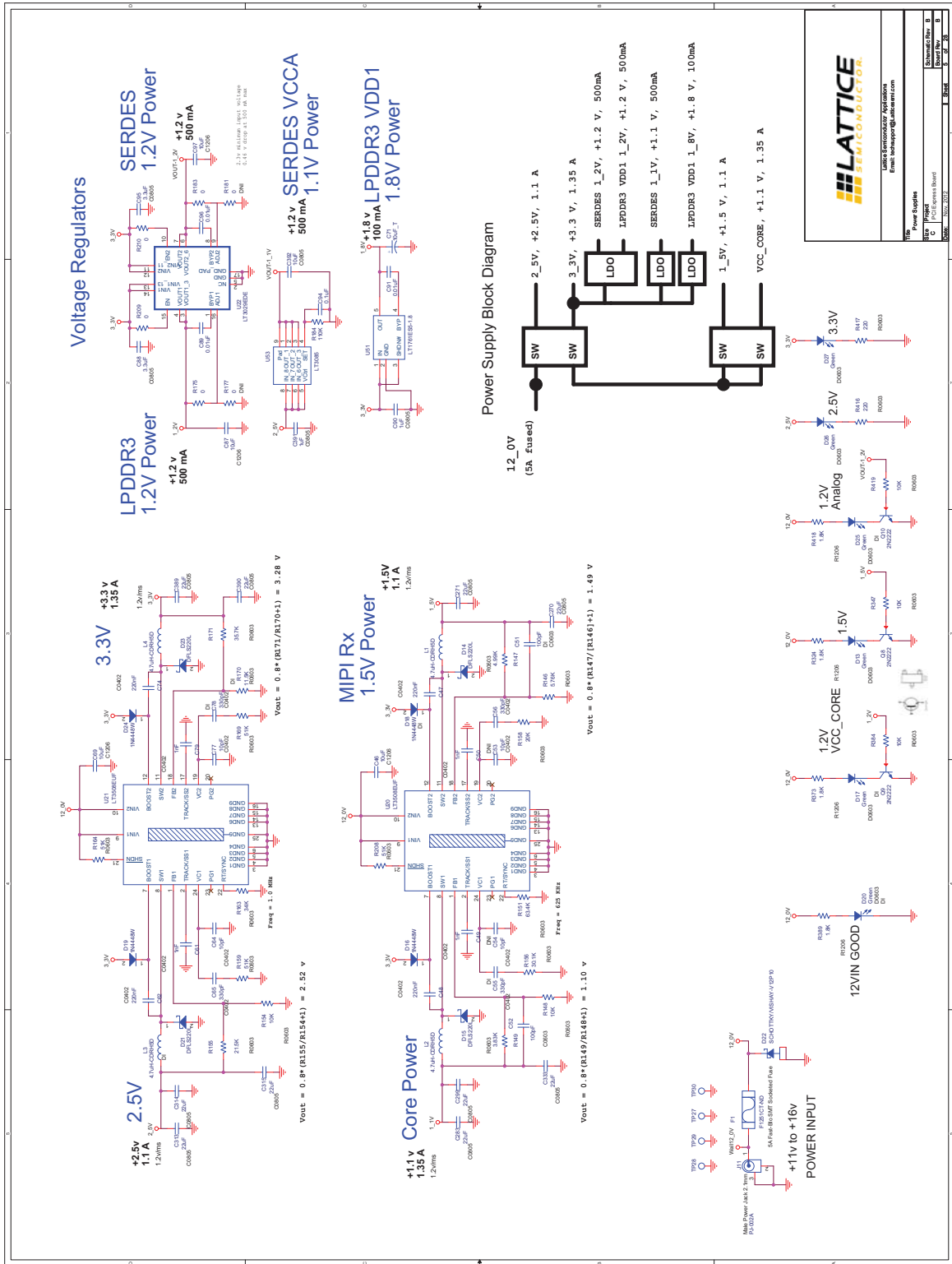





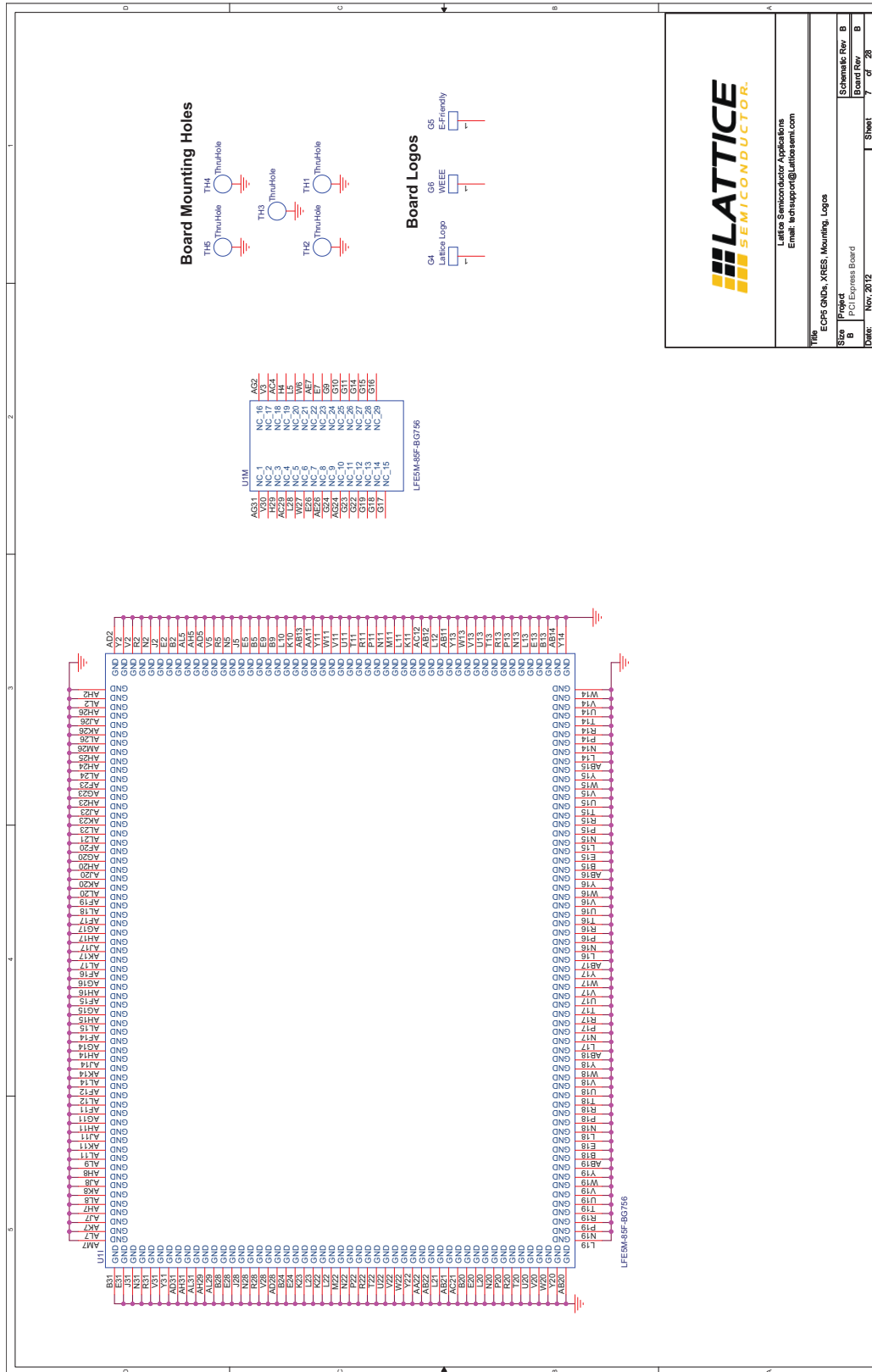

Lattice Semiconductor Applications  
Email: [apps@lattice.com](mailto:apps@lattice.com)

**Title:** ECP5 GNDx\_XRES\_Mounting\_Logos

<b>Size:</b> B	<b>Project:</b> PCI Express Board	<b>Schema Rev:</b> B
<b>Board Rev:</b> B		

**Date:** Nov, 2012 **Sheet:** 7 of 28

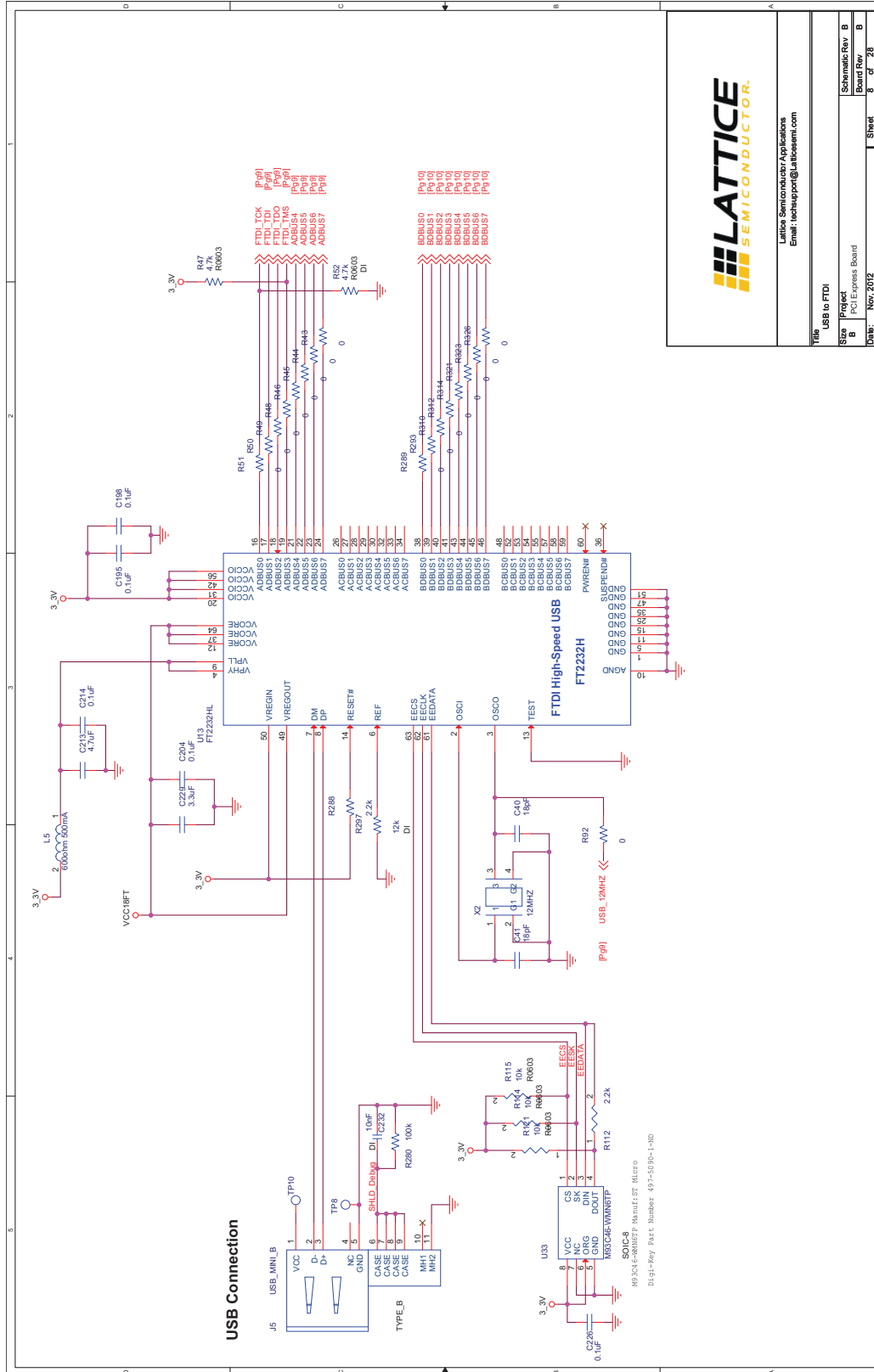

Lattice Semiconductor Applications  
Email: techapp@lattice.com

Title		USB to FTDI
Size	Project	B
Board Rev	Board Rev	B
Drawn	Sheet	8 of 28





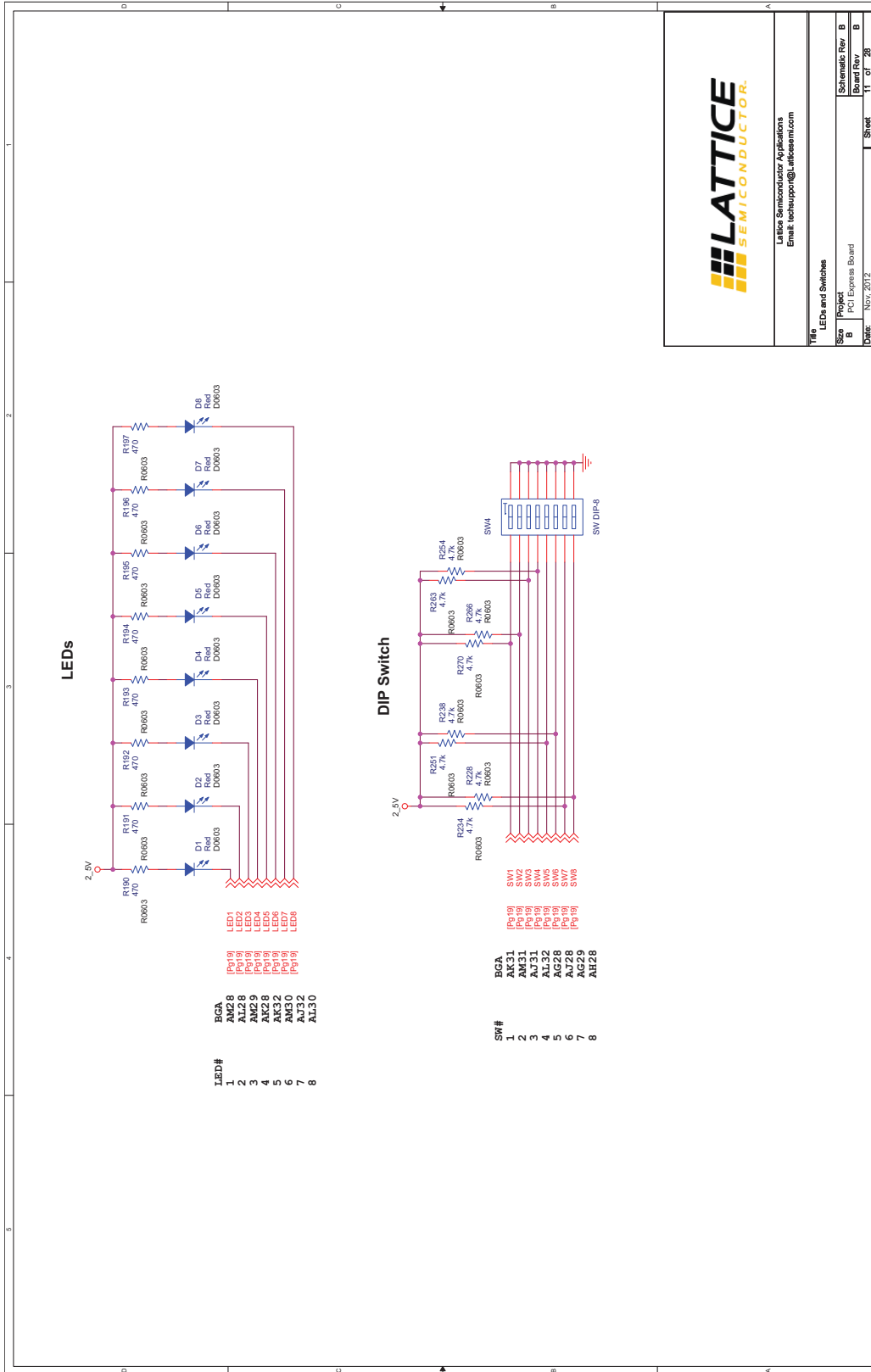

Lattice Semiconductors Applications  
Email: techsupport@lattice.com

Title		LEDS and Switches	
Size	Project	Schematic Rev	B
B	PCI Express Board	Board Rev	B
DATE	Nov, 2012	Sheet	11 of 28



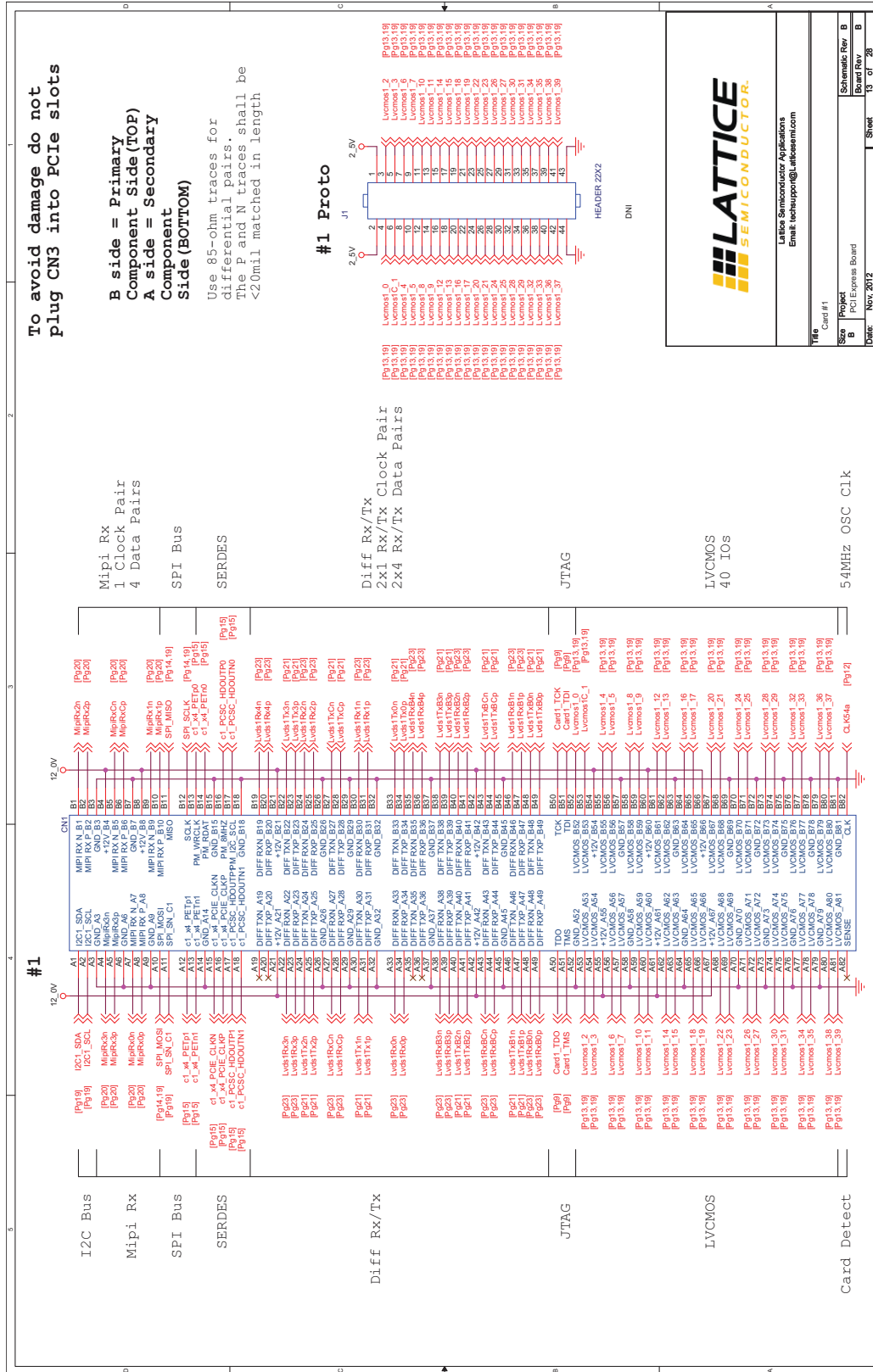

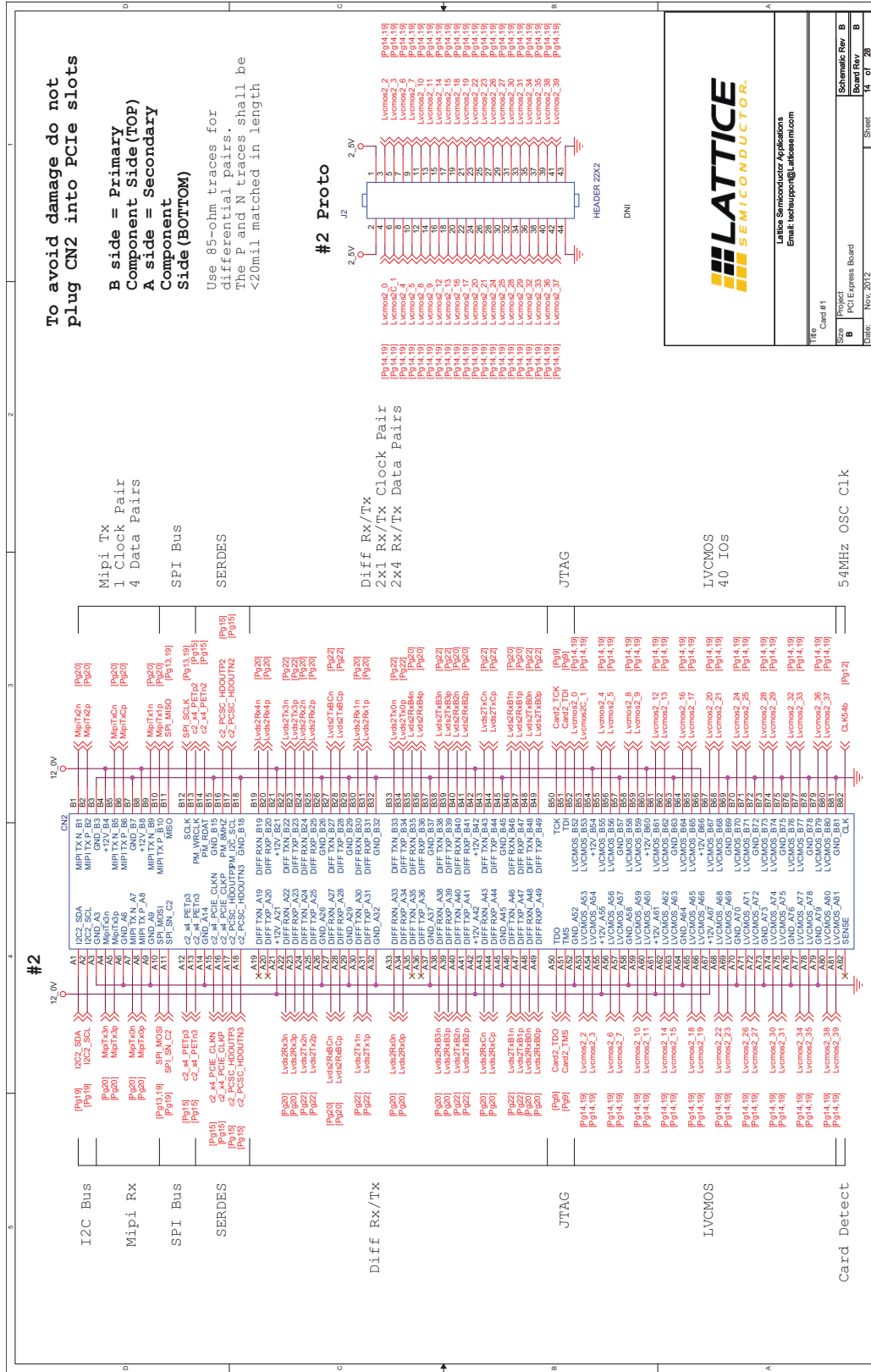





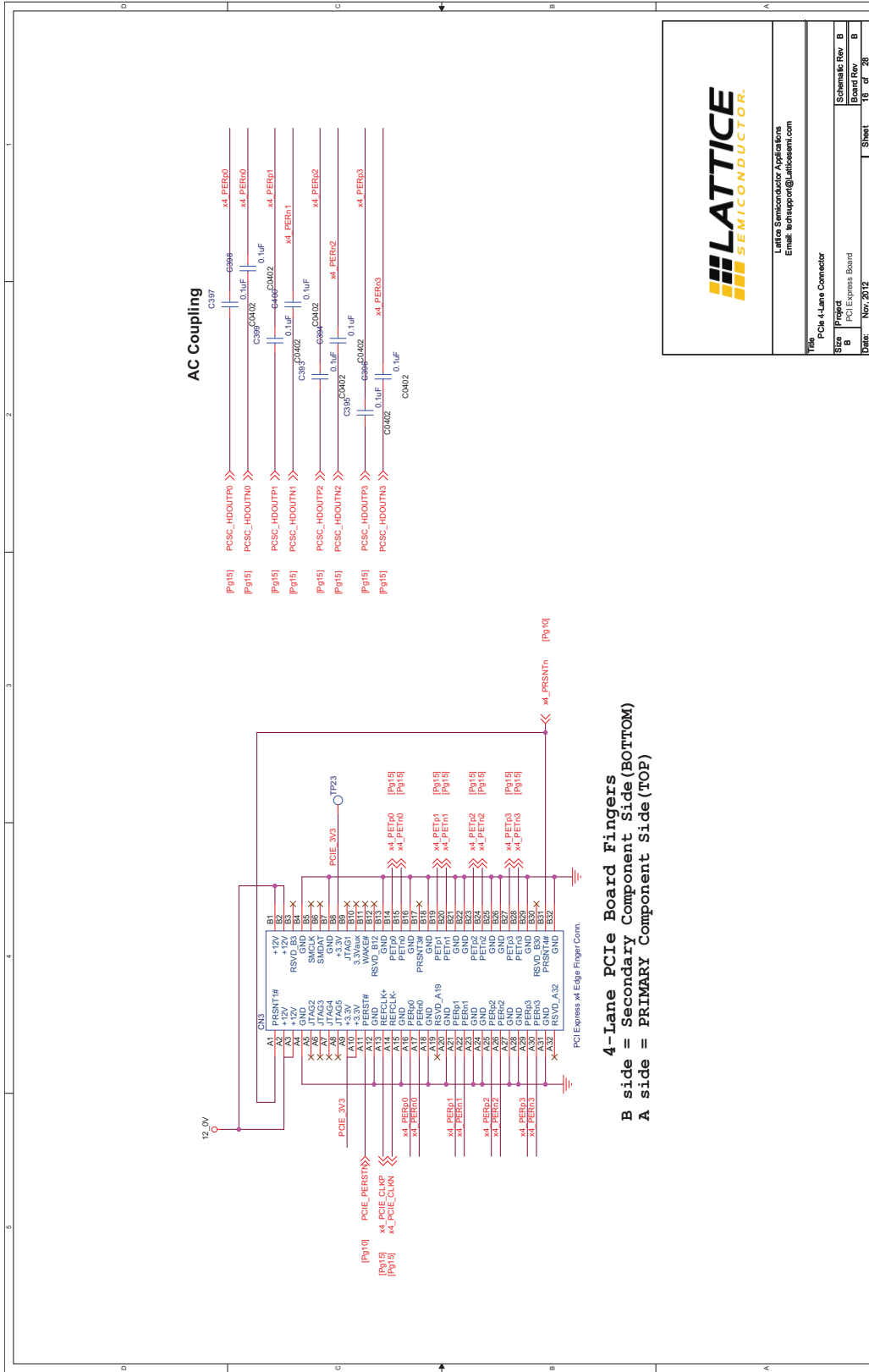

**4-Lane PCIe Board Fingers**  
 B side = Secondary Component Side (BOTTOM)  
 A side = PRIMARY Component Side (TOP)

Lattice Semiconductors Applications  
 Email: [lsupport@lattice.com](mailto:lsupport@lattice.com)

Title: PCIe 4-Lane Connector  
 Size: Project B  
 Board: PCI Express Board B  
 Date: Nov. 2017 Sheet 18 of 28

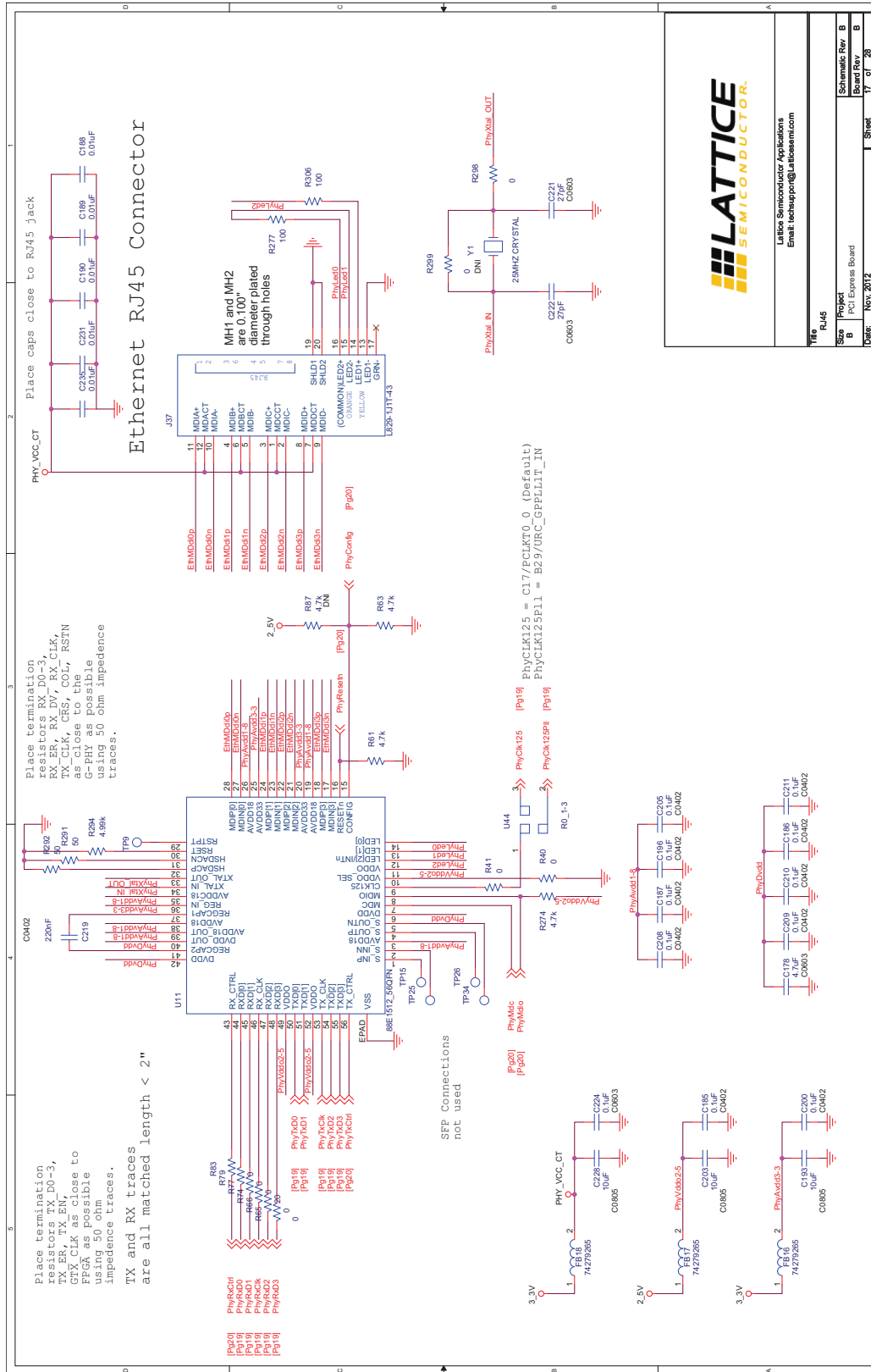

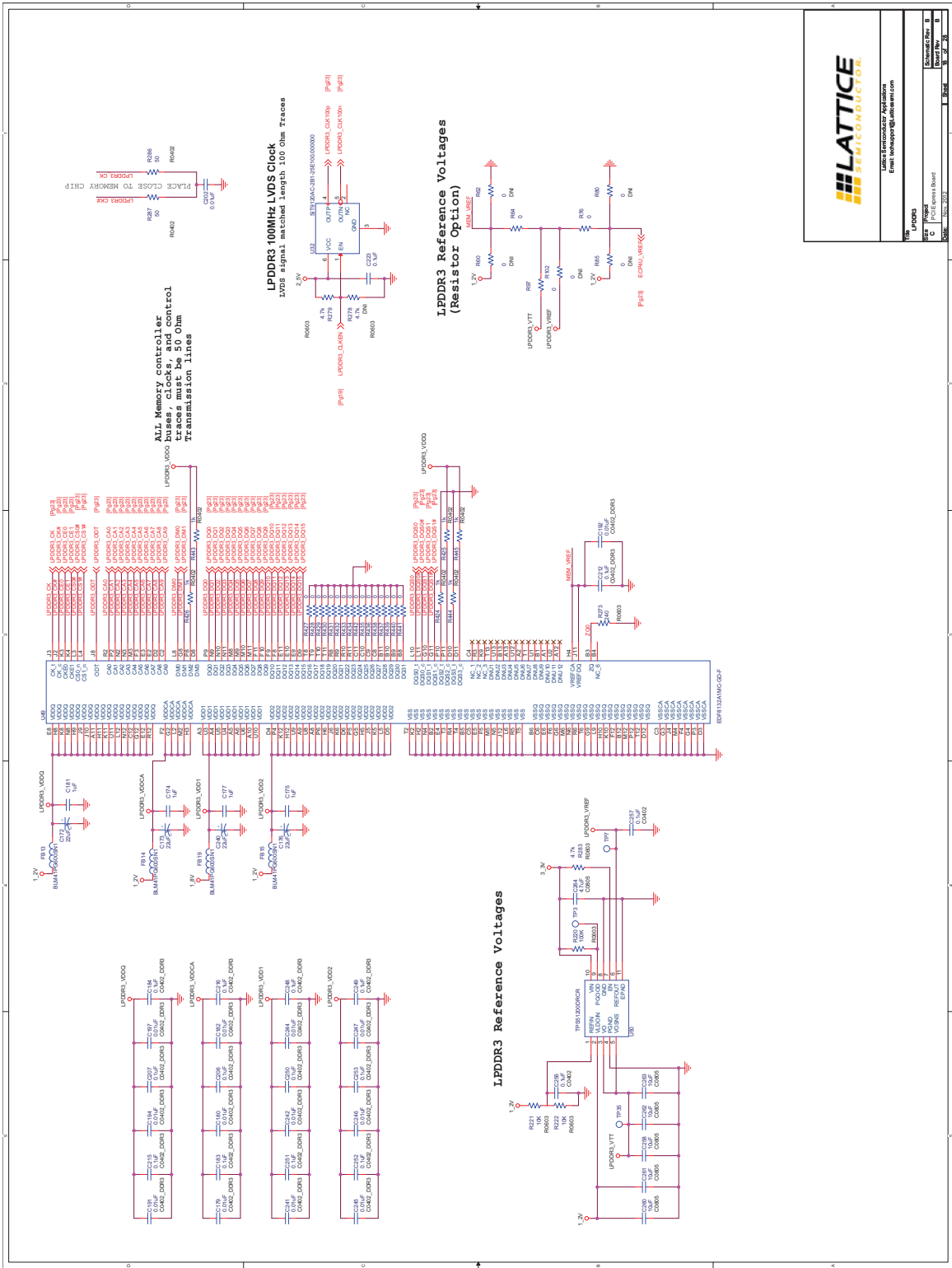

**LATTICE**  
SEMICONDUCTOR

Lattice ECP5 PCI Express Board Application  
Email: techsupport@lattice.com

Rev: 1.0  
Date: 01/15/2014  
Part Number: ECP5-PCI-EXPRESS-BOARD  
Revision: 1.0  
Date: 01/15/2014



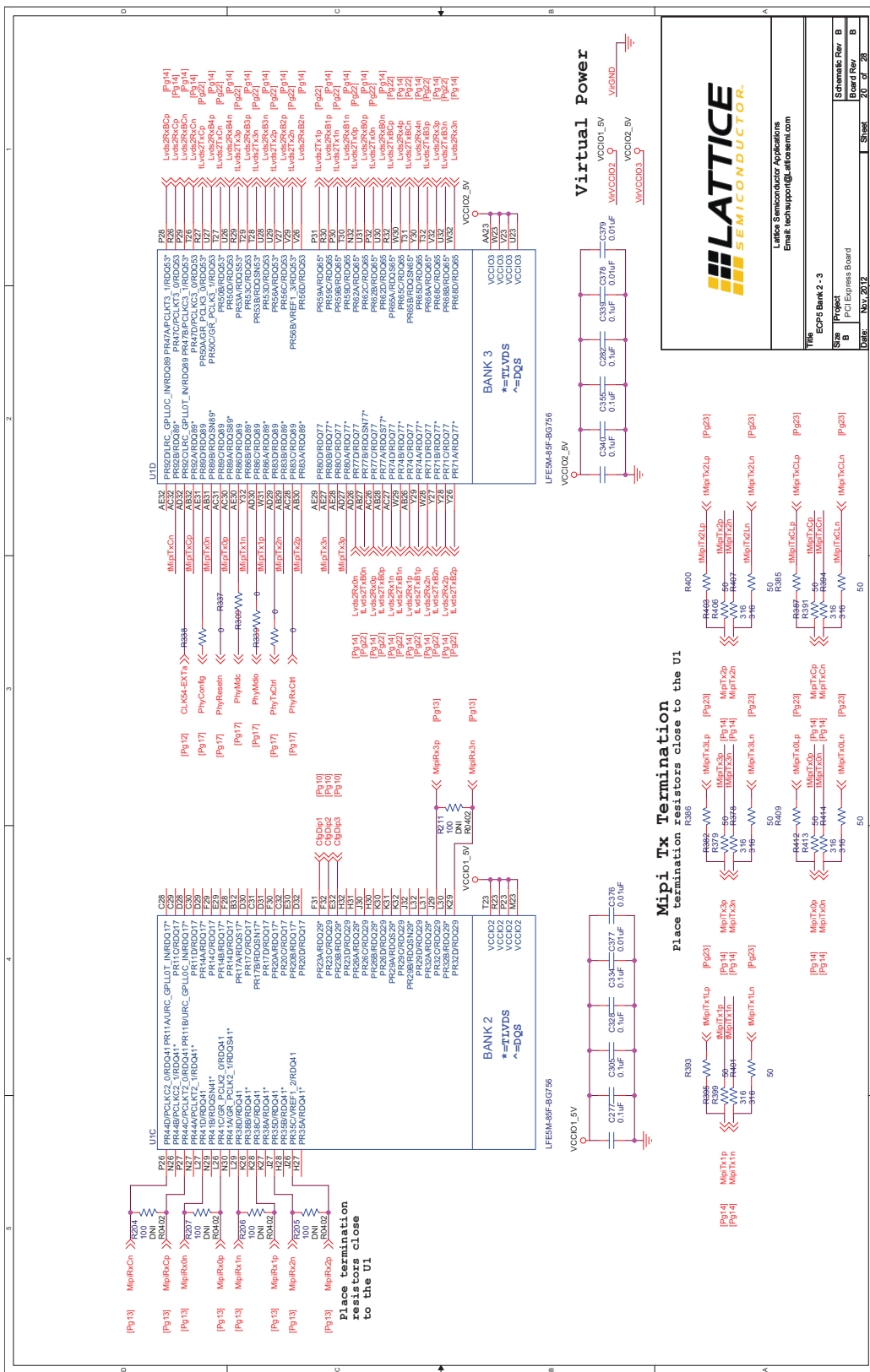

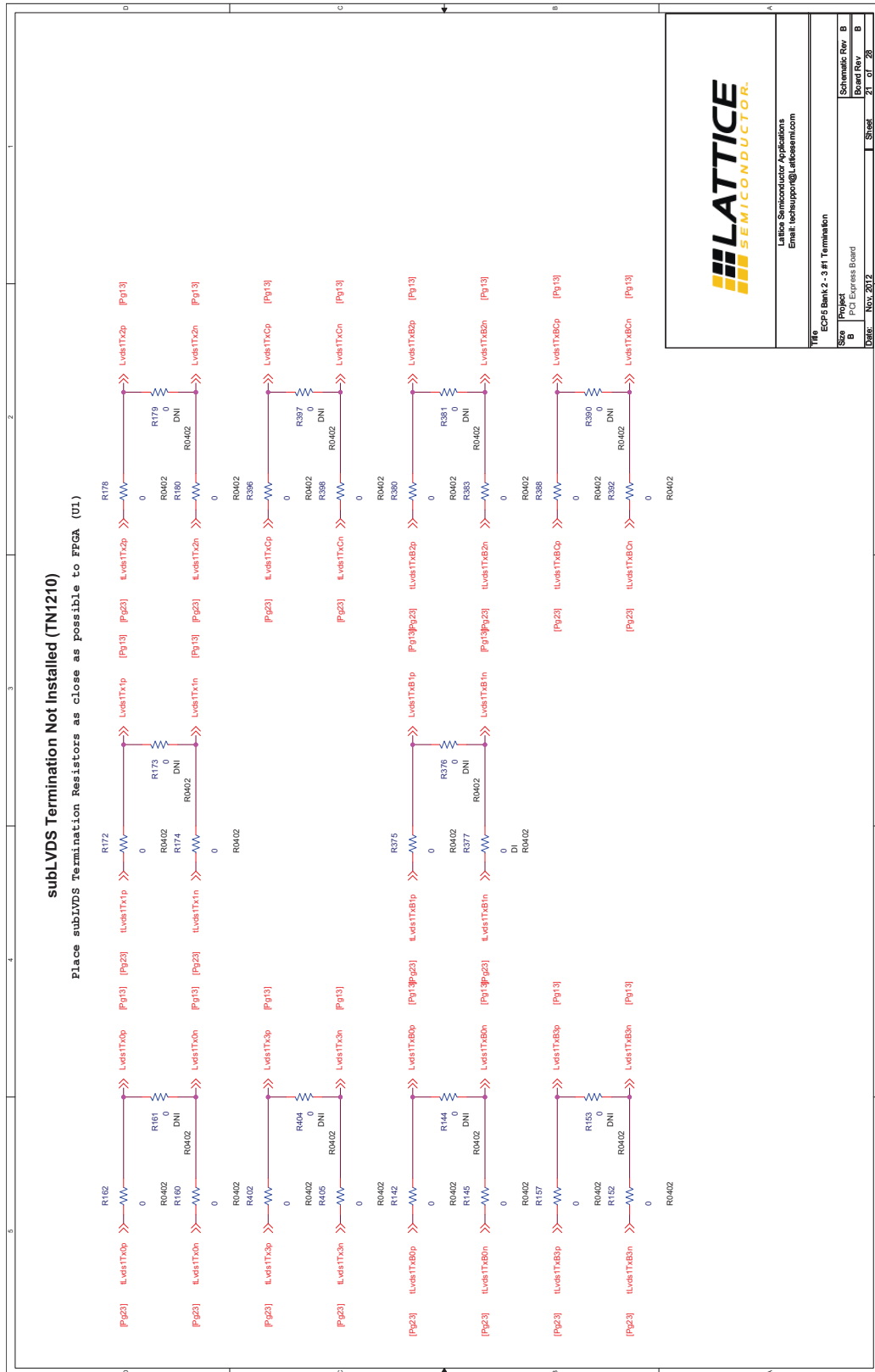

Lattice Semiconductor Applications  
Email: techsupport@latticesemi.com

Title		ECP5 Bank 2 - 3 #1 Termination	
Proj	Project	PCI Express Board	
Rev	Revision	Schematic Rev. B	
Date	Date	Nov 2012	
Sheet	Sheet	21 of 28	

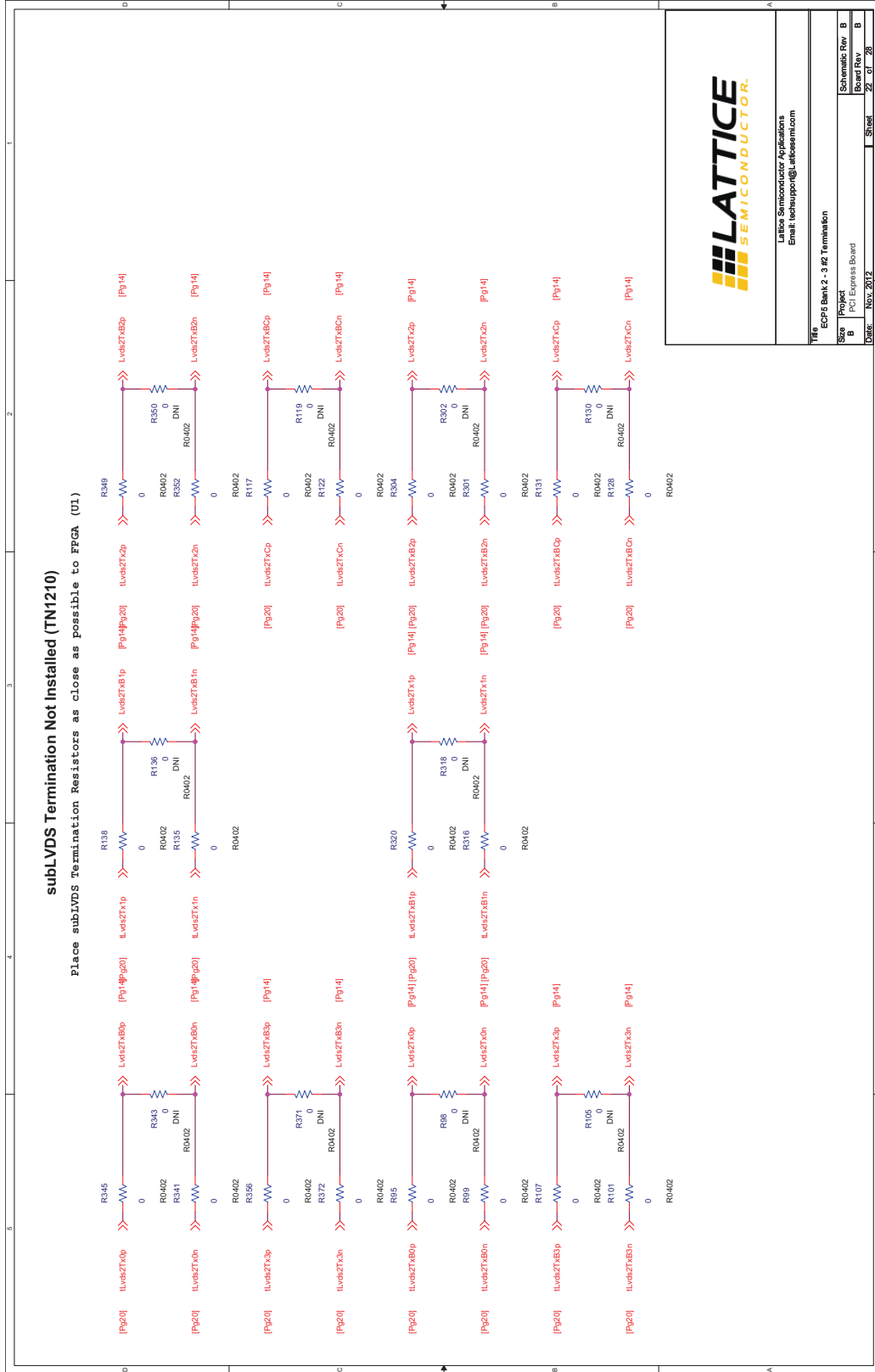

**LATTICE**  
SEMICONDUCTOR.

Lattice Semiconductor Applications  
Email: techsupport@lattice.com

Title	ECP5 Bank 2 - 3 #2 Termination
Project	PCI Express Board
Sheet	22 of 28
Date	Nov 2012
Schematic Rev	B
Board Rev	B



