

REV
B DT06-12S*-EP20

REVISIONS			
SYM	DESCRIPTION	DATE	APPROVED
NC	NEW RELEASE PER E.O. P18803	2/28/05	R.D.R.
A	RELEASE PER E.O. P20698	12/23/10	R.D.R.
B	REVISED PER E.O. P20848	3-25-11	<i>ADL</i>

DATE CODE: MONTH REPRESENTED
BY SEQUENTIAL ALPHA CHARACTERS.
EX. A = JANUARY

DATE CODE: YEAR IS REPRESENTED
BY LAST NUMERICAL DIGIT.
EX. 5 = 2005

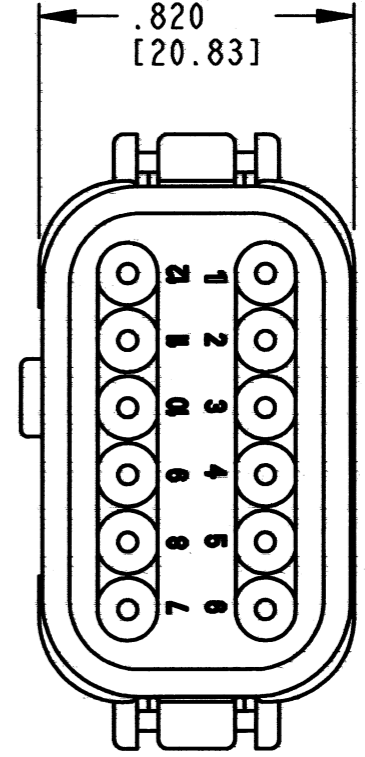
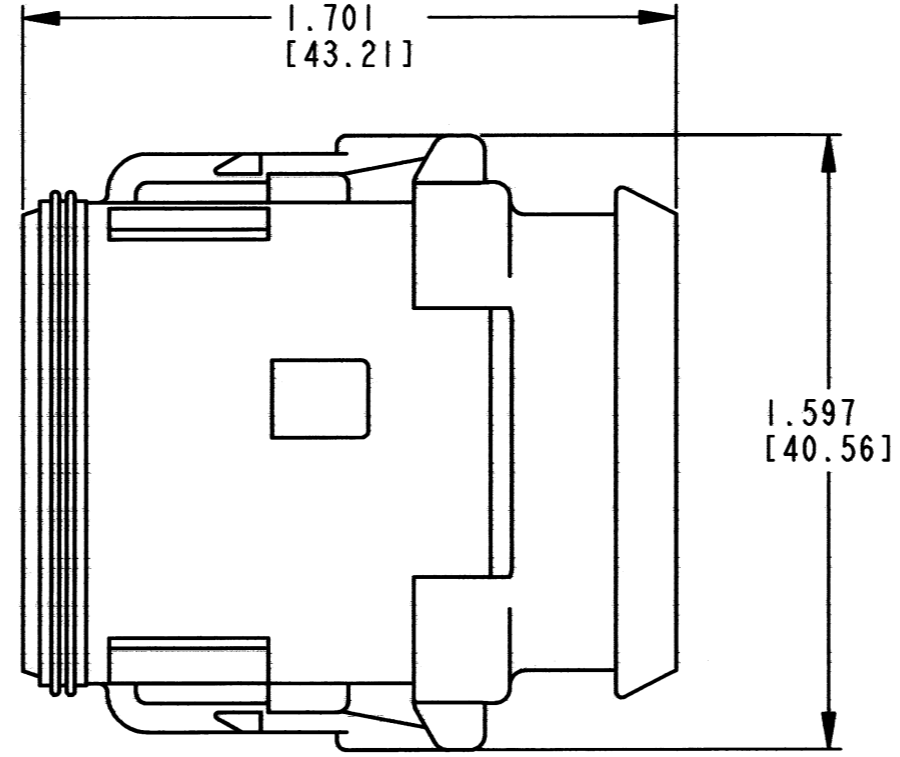
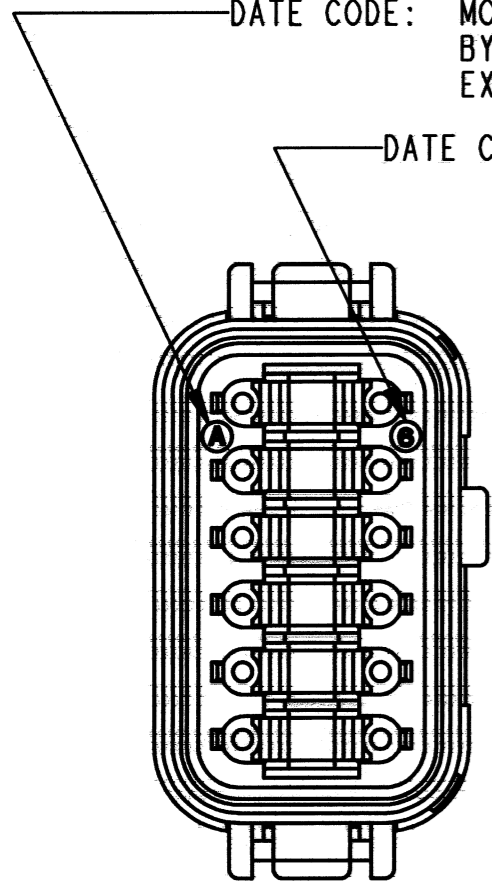

- 5. SHELL MATERIAL: PLASTIC;
SEAL MATERIAL: RUBBER.
- 4. THIS PLUG MATES WITH DT04-12P*-**** RECEPTACLE.
(**** = ALL MODIFICATIONS). CONSULT FACTORY FOR ALL MODIFICATIONS.
- 3. FOR CONTACTS AND WIRE PERFORMANCE AND APPLICATION CHARACTERISTICS,
SEE ENVELOPE DRAWINGS 0425-015-0000 AND 0425-017-0000.
- 2. DIMENSIONS ARE ±.025[.64] UNLESS OTHERWISE SPECIFIED.

NOTES: 1. ALL DIMENSIONS ARE INCHES (MILLIMETERS).

CONTACT SIZE	MIN. INSUL O.D.	MAX. INSUL O.D.	WIRE RANGE [mm ²] REF. ONLY ³
16	.088 [2.24]	.145 [3.68]	14-20 AWG [2.0-0.5]

SIGNATURE & DATE	
DR	X. SANCHEZ 03MAY04
CHK	<i>B. P. Ford</i> 3/23/2011
PE	<i>R. Messinger</i> 3/15/11
APPD	<i>S. Beard</i> 3/12/11
SCALE	NONE WT

12 WAY PLUG
-EP20 MOD.
D.T. SERIES

ENVELOPE

EP	MATL. CODE
 3850 INDUSTRIAL AVE. HEMET, CA 92545 DEUTSCH INDUSTRIAL	
B	DT06-12S*-EP20
DWG SIZE	CODE 11139 SHEET 1 OF 2

REV
B DT06-12S*-EP20

REVISIONS			
SYM	DESCRIPTION	DATE	APPROVED
B	SEE SHEET ONE	3-25-11	ADR

PART NO: DT06-12SA-EP20
 KEY ARR. -A-
 COLOR: GRAY

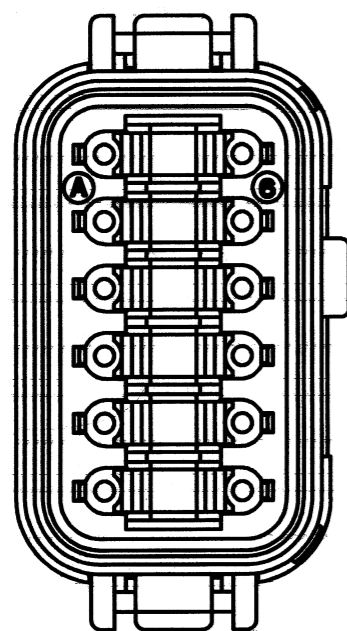

PART NO: DT06-12SB-EP20
 KEY ARR. -B-
 COLOR: BLACK

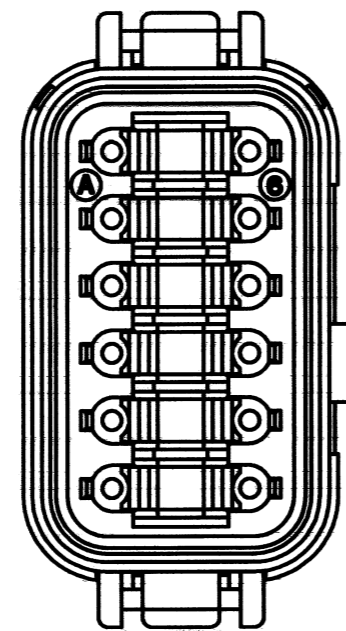

PART NO: DT06-12SC-EP20
 KEY ARR. -C-
 COLOR: GREEN

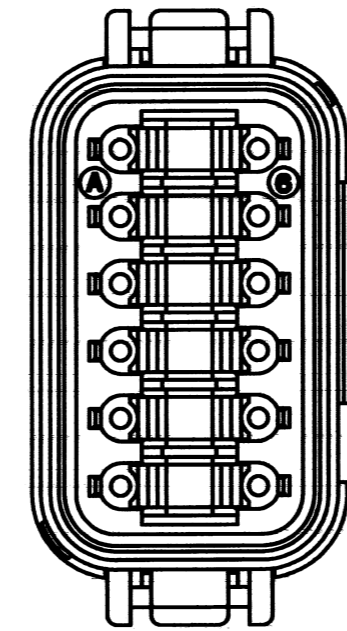

PART NO: DT06-12SD-EP20
 KEY ARR. -D-
 COLOR: BROWN

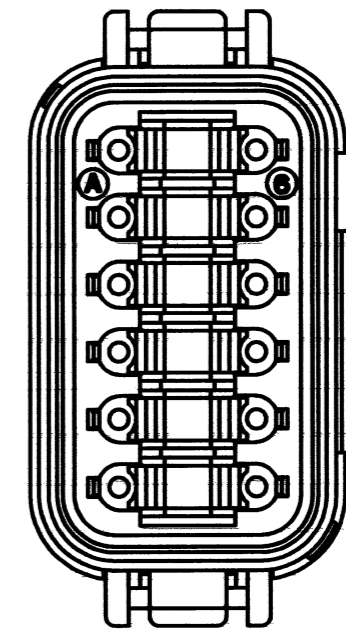

NOTES: SEE SHEET ONE

SIGNATURE & DATE	
DR	X. SANCHEZ 03MAY04
CHK	<i>[Signature]</i> 3/23/2011
PE	<i>[Signature]</i> 3/15/11
APPD	<i>[Signature]</i> 3/18/11
SCALE	NONE WT

12 WAY PLUG
 -EP20 MOD.
 D.T. SERIES

ENVELOPE

EP	MATL. CODE
 3850 INDUSTRIAL AVE. HEMET, CA 92545	
B	DT06-12S*-EP20
DWG SIZE	CODE 11139 SHEET 2 OF 2