

Brad[®] AUTOMATION > INDUSTRIAL IO DESIGNER GUIDE

European Core Program

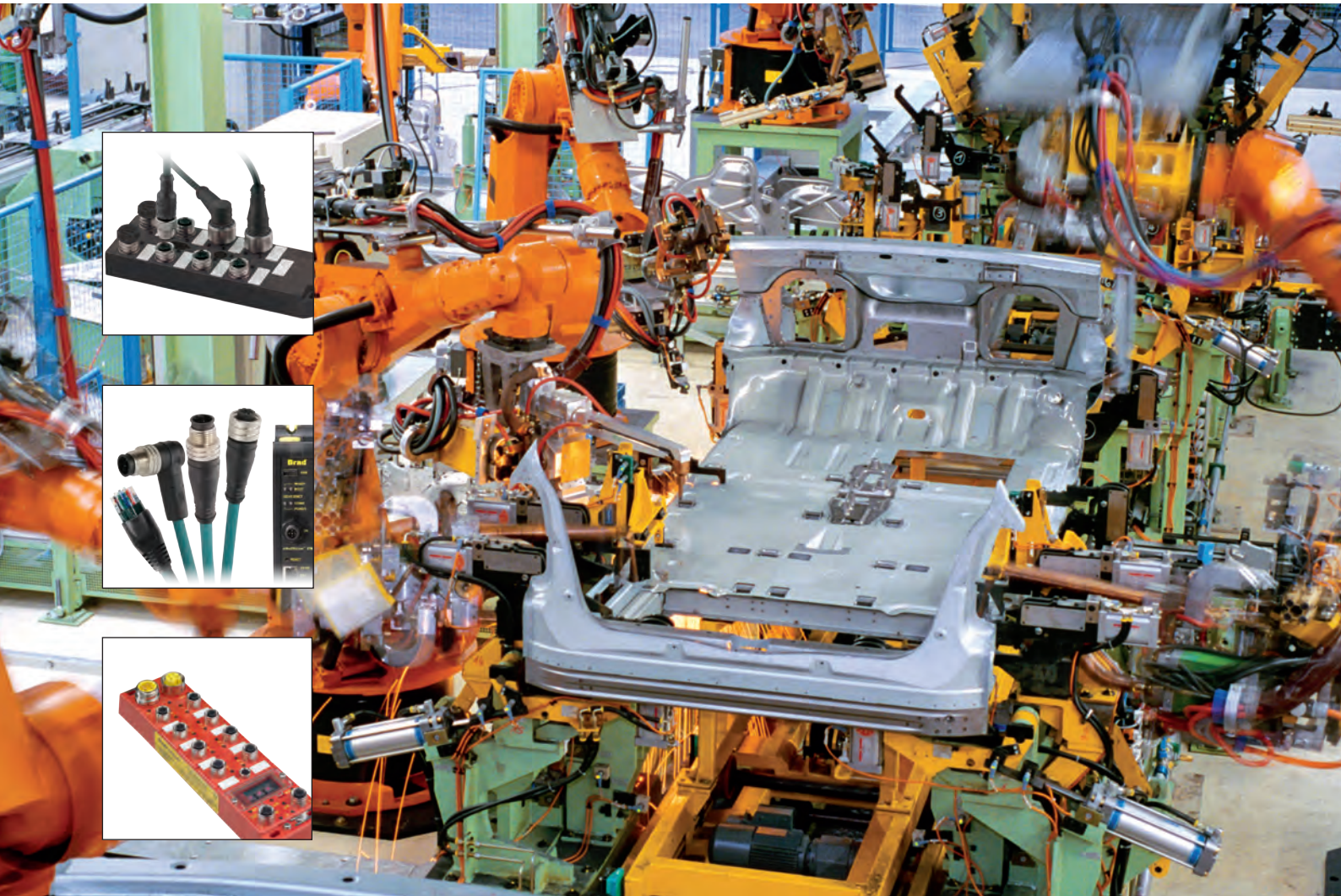

molex[®]

Find the Latest Innovations and Information **at molex.com**

For the most in-depth and up-to-date information on all our products, visit molex.com. It's designed to help you get more done in less time with advanced search capabilities, 3D models, product specifications, easy sample ordering and more.



Mobile App for Anytime, Anywhere Access to Molex Connector Solutions.

The Molex App gives apple and android tablet and smartphone users ready-access to information on over 90 different Molex product families. Users can visually compare product ranges, access product information and view datasheets offline. App users with an internet connection can directly link to Molex.com for more detailed part number information and product videos. Download the free app now at the App Store and GooglePlay.

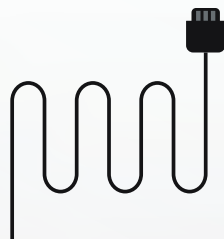
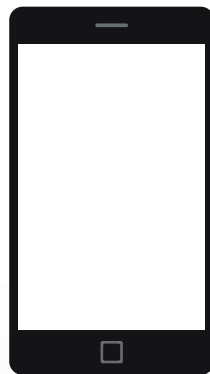

TABLE OF CONTENTS

Molex Infrastructure Advantages and Benefits

6

ETHERNET Infrastructure Components

Brad® PROFINET HarshIO Modules	16
Brad® EtherNet/IP HarshIO Modules	19
Brad® O-Link HarshIO devices	23
Brad® IP67 MODBUS TCP Digital Classic HarshIO Modules	24
Brad® Harsh-Duty Ethernet Switches	25
Brad® PROFINET Infrastructure Components	26
Brad® EtherNet/IP Infrastructure Components	28
Brad® Ethernet X-Code and M8 Infrastructure components	30
Brad® Ethernet Infrastructure Accessories	31

PROFIBUS Infrastructure Components

Brad® PROFIBUS Digital Classic HarshIO Modules	34
Brad® PROFIBUS Digital Compact HarshIO Modules	35
Brad® PROFIBUS Infrastructure Components	36

POWER Distribution Components

Brad® Mini-Change® 7/8" Auxiliary Power Infrastructure Components	40
Brad® M12 A-Code Auxiliary Power Infrastructure Components	42
Brad® M12 T-Code Auxiliary Infrastructure Components	44

Sensors and Actuator Wiring

Brad® MPIS® Sensor/Actuator Distribution Boxes	48
Brad® Micro-Change® M12 Sensor/Actuator Connectivity	50
Brad® Micro-Change® M12 with LED	52
Brad® Micro-Change® M12 Shielded Cable	53
Brad® Micro-Change® M12 Sensor/Actuator Connectivity	54
Brad® Nano-Change® M8 Sensor/Actuator Connectivity	57
Brad® mPm® DIN Valve Connectors	57

Complete Solution For Automation Infrastructures In Harsh Environments

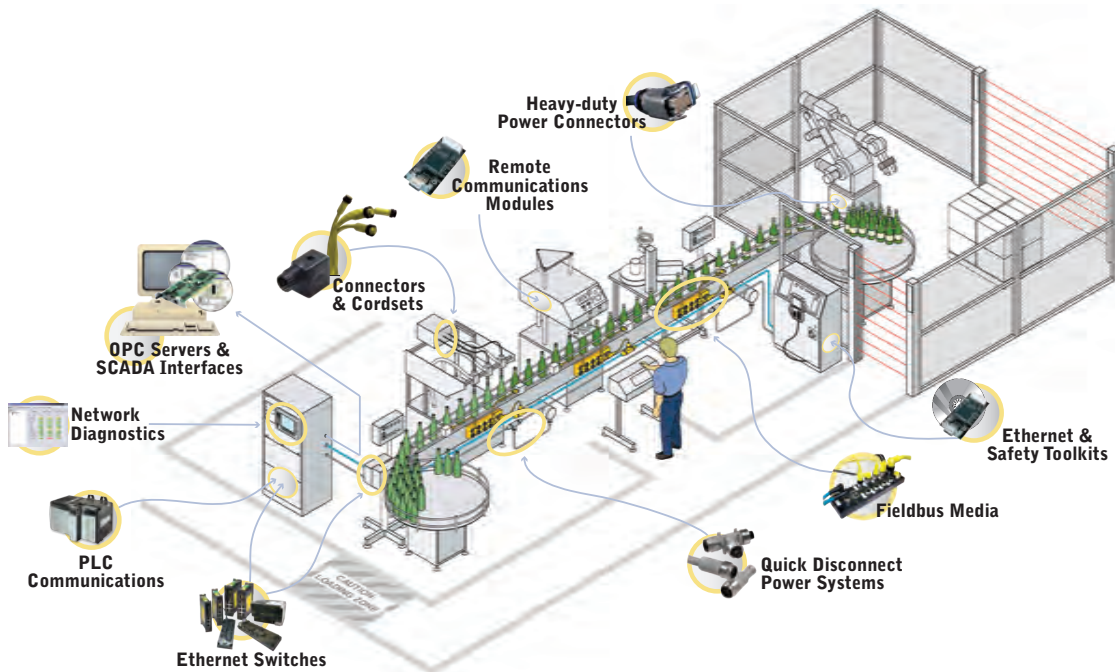

All trademarks used herein are the property of their respective owners. Reference to any non-Molex trademarks is not intended to claim any endorsement or association between Molex and the respective trademark owners, and should not be construed.

molex®

- **Molex Market Segments**

Brad® products have been the standard for harsh duty connectivity systems in the industry since the invention of the Mini-Change® connector in the early 1970s. Our team of highly-skilled experts is focused on designing innovative product solutions for reliable communication, power distribution, and control aimed at reducing capital equipment costs and downtime and increasing worker safety for various markets.

- **Automotive Automation**

Molex products are specified and widely in use for automotive applications across the world in areas as Body in White, Powetrain or painting & stamping productions. This success is based on the strong withstand against the taffest requirements of such production plants like the resistance to weld slag or high flexibility for use in robots arms.

The Molex expertise in Ethernet based communication protocols allows to provide innovative I/O infrastructure solutions with quick startup for robot tool changing applications as well as for the integration of safety equipments enabling to consolidate all type of signals in one network.

- **Material Handlin**

Molex focuses on a large connectivity portfolio with the round sealed connector standards for I/O signals as well as dedicated power solutions. Combining this large expertise in the molex modular Heavy Duty Connectors allows to consolidate the various types of signals required in material handling applications into one interface, standardizing and simplifying the wiring and installation.

Roller drives devices can be integrated to Ethernet based networks through Molex HarshIO modules for thigh control of conveying logic.

- **Food and Beverage**

Molex IP9K UltraLock M12 connectors are completing the IP68 threaded M12 connectors and are best suitable for the dry or wet areas of the food and beverage industry. UltraLock as fast locking system is available through the complete HarshIO program allowing as well to safe tremendous installation time.



The products you need... when and where you need them.

The Brad® Core Program

- Molex® supports one of **the largest portfolios of connectivity and wiring solutions** in the industrial market for automotive manufacturing, automated machine tools, food and beverage, material handling and packaging, commercial vehicles and solar applications.
- The core program is part of this portfolio that is **focused on the standard requirements** related to automation in the European market and highlights the active and passive IO modules and the related connectivity products for installation in harsh environments.
- Molex® commits to timely availability of all parts listed here in this core program and can propose dedicated delivery process to adapt the timings or the package of the solution chosen by our customers.
- Molex® commits to **supporting its customers** by helping them choose the right network as well as the most optimized infrastructure solution for their application. The Molex® tech support team also supports its customers in selecting corresponding parts from the complete portfolio or designing customer-dedicated solutions and prototyping.
- Beyond all part numbers available in this catalog dedicated to the standard IO interconnectivity, Molex offers custom part availability (length, labeling, further connector variations...) as well as a huge range of complementary products that would cover all aspects of the automation infrastructures.

Molex® has the right solution for your automation application!

Complete Solutions from Molex

Molex is focused on offering added value solutions to the targeted markets by having long years of expertise and technology in communication protocols and interconnectivity solution as well as various plants for in house production worldwide.

Competitive Advantages:

- **Molex is a recognized Industrial Communication Competence Center**
Active in Automation and industrial committee boards like PNO, ODVA, CLPA, IEC, etc.
- **Molex design and market its own Industrial communication technology**
PROFINET, EtherNet/IP and safety stacks widely in use by many the major automation manufacturers
- **Support of large fieldbus communication Safe and non Safe**
 - Non-Safe: PROFIBUS, PROFINET, DeviceNet, EtherNet/IP, CC-Link, CC-Link IE, CanOpen, Modbus, EtherCAT, IO-Link.
 - Safe: CIP Safety, PROFI-safe, CC-Link IE Safety
- **Product design and Manufacturing Integration Capabilities**
 - Product development and customization
 - Product testing
 - Total Quality Process
- **Fully Integrated Capabilities**
Stamping, plating, moulding, assembly, electronic population and assembly, potting and overmolding

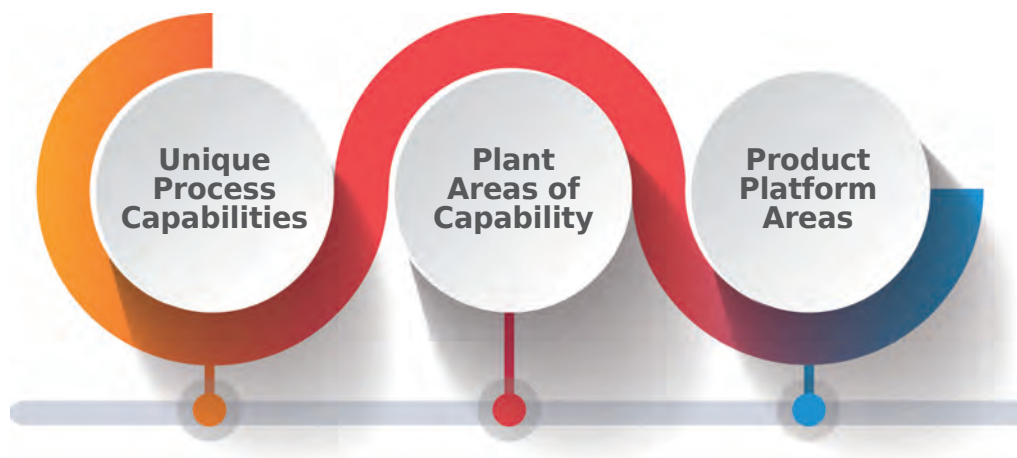



Ethernet IO reliable connections in harsh environments

Worldwide Unique Feature: Quicker Setups and More Uptime through Secure Connections Using the Brad® Ultra-Lock® Patented Connection System

- One simple push delivers a secure, consistent seal each and every time
- Eliminates connector-related intermittent signals that lead to costly production downtime
- Quick change-overs can now be a reality

React to Problems Sooner Using Easy-to-Read Diagnostics

- Visible LEDs provide maintenance personnel with ability to easily determine I/O, module and network status
- Scrolling 4-character display for IP addressing and module status
- Built-in web server for remote monitoring, configuration and diagnostics

Reduce Infrastructure Costs with Built-in 2-Port Ethernet Switch

- 10/100 Mbps auto-sensing
- Supports straight or crossover Ethernet cable

Reduce Inventory Costs Using Configurable I/O

- User configurable – 16 points of digital I/O can be set as either an Input or Output (also available in fixed I/O configurations)

Save Time Configuring or Replacing I/O Modules

- On PROFINET or EtherNet/IP, configuration setup can be downloaded on the HarshIO directly from the Master, IO-Controller or Scanner
- With simple-to-use push buttons, quickly adjust the last three octets of the IP address

Save Energy by Minimizing Power Supply

- On PROFINET, HarshIO supports PROFIenergy service, allowing the IO-Controller to minimize power supply to the connected HarshIO Module(s)

Built-in Web Server

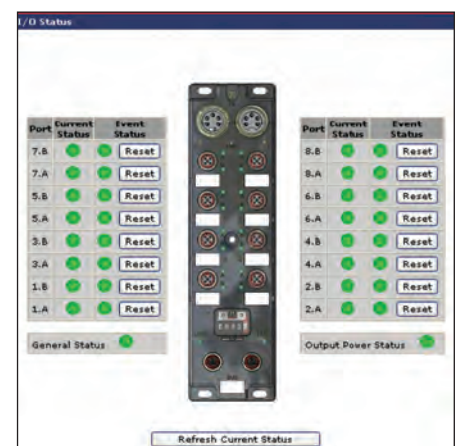

Push Buttons

Two push buttons located above the display window are used to:

1. Quickly adjust the last octet or last 3 characters of the module's IP address

2. Scroll through and view the Ethernet configuration mode

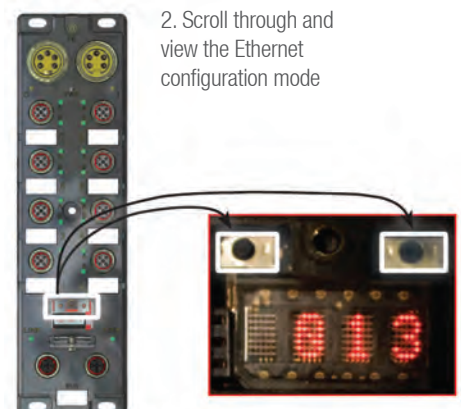

Brad® HarshIO IO-Link Solutions



Brad® HarshIO modules supports the IO-Link Master communication standard to extend the digital link down at the sensor and actuator level. The capabilities and modularity of the IP67 solution are strongly enhanced in combination with the Brad® IO-Link digital IO Hubs and analog adapters.



IO-Link, the Sensor/Actuator communication standard

- Increase up to 32 bytes the data amount with field devices
- Flexible production through online sensor parametrization
- Reduced maintenance and downtime through improved diagnostic capabilities

Infrastructure simplification and savings

The IO-Link technology allows significant infrastructure cost reductions compared to traditional shielded wiring required for analog signals or for networks and additional power supply cordsets as IO-Link requires only standard unshielded 3-pole cordsets and includes also the power supply for equipment.

Extreme modularity in IP67 protection

Each of the 8 IO-Link Master ports of the HarshIO module can be configured to manage standard digital I/O signals, high diversity of IO-Link devices or combined with Brad® Analog Adapters any kind of Input or Output analog signals.

Molex IO-Link infrastructure devices are listed in the Ethernet Section following the description of the IO-Link HarshIO module.

Digital I/O concentrator

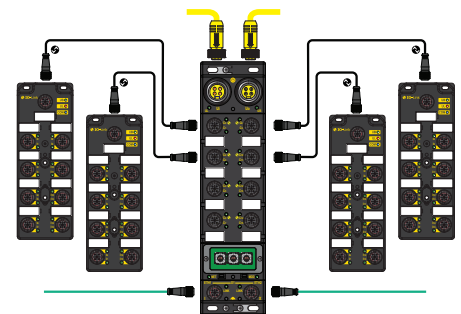

IO-Link allows to connect up to 8 IO-Link digital IO Hubs to extend the total count of digital I/O manageable by a single HarshIO IO-Link module up to 136 points, reducing the overall cost of I/O points.

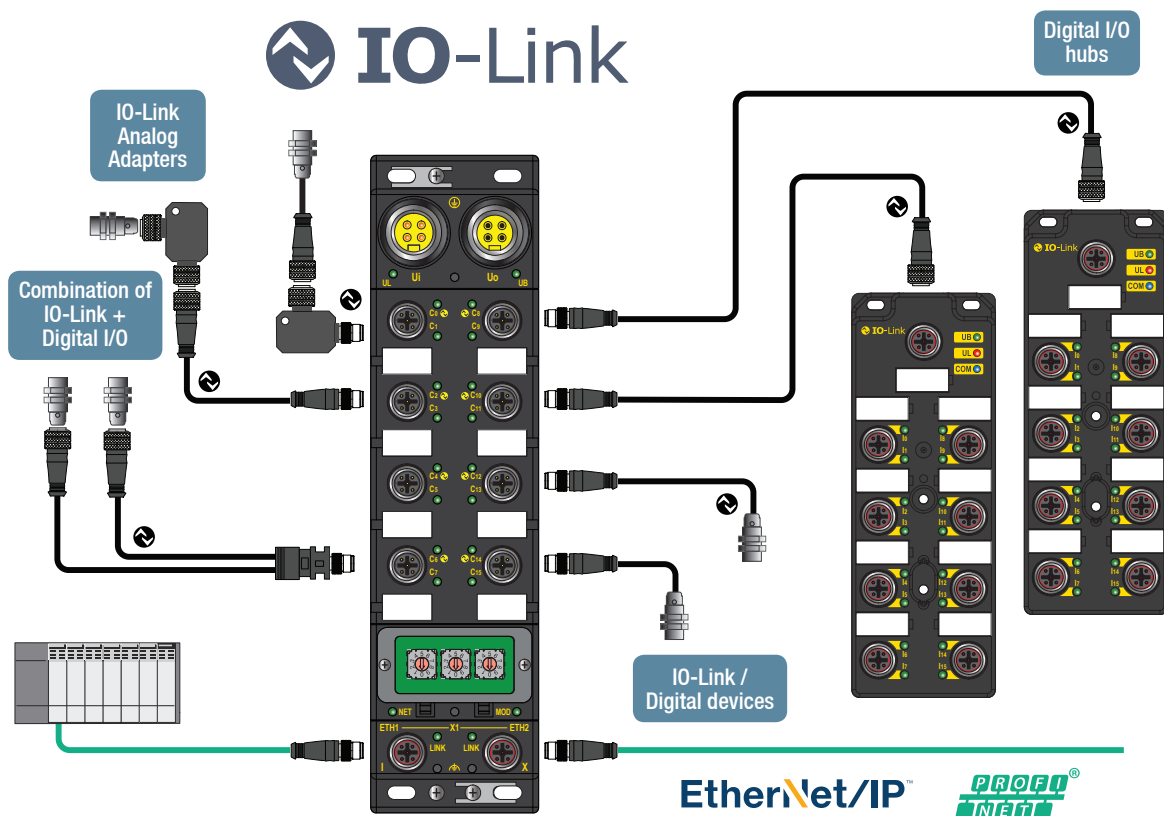

Brad® Ethernet/IP MDR Conveyor Classic Harsh IO Modules

molex®

Brad® MDR Conveyor Classic HarshIO Modules provide a reliable solution for designing industrial Motor Driver Roller (MDR) applications in harsh duty environments. Each module can connect 4† drives and enables, through EtherNet/IP* network, the control from a PLC of the start/stop and set 15 different speeds.



HarshIO Modules Benefits

- Simplifies systems by enabling up to 4 motor drive rollers to connect to one module
- Reduces the total number of power and network cables
- Achieve complete module and harness modularity with an optional hybrid 24V DC Power and Industrial Ethernet cable harness available in various lengths
- Eliminates the requirement to use a proprietary system from an MDR manufacturer‡
- Brad® Ultra-Lock® M12 technology delivers reliable and fast connection
- EDS files can be uploaded from the module for an easy integration in Rockwell Automation Studio 5000 Logix Designer™ software or any other EtherNet/IP* PLC engineering tool
- I/O diagnostics and LEDs: quickly identifies problems and helps reducing machine downtime



Typical Conveying Application

Ideally suited for many material handling applications such as postal distribution centers, airport baggage handling and conveying systems for production plants.

Combining Brad connectivity (power, I/O and network corsets) and IP67 HarshI/O modules (digital, IO-Link and safety) , Molex is able to deliver ready-to-use solutions to design conveying applications.

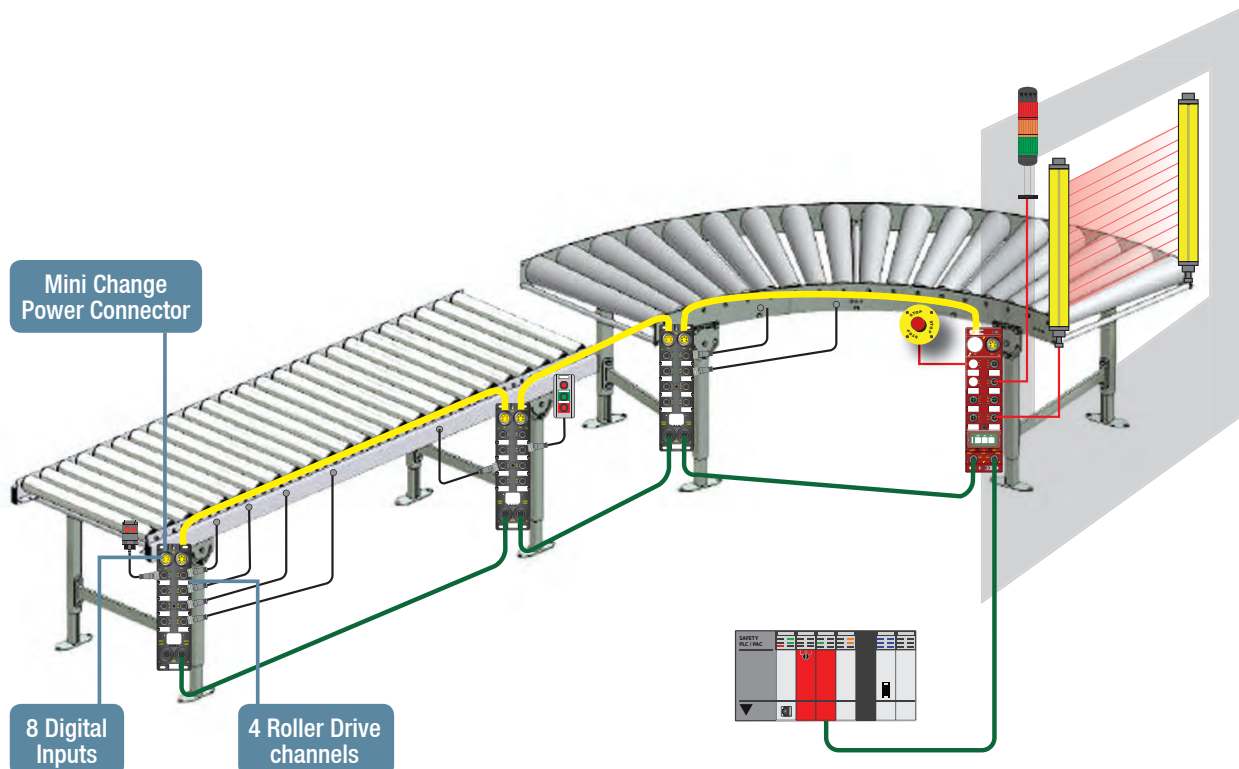

* Ethernet/IP is a trademark of the Open DeviceNet Vendor Association (ODVA).

† One 9A external fuse is required in front of the module input power supply. In the case of daisy-chained modules, the external fuse shall still be located in front of every module.

‡ Depending on the application and configuration requirements.

Brad® HarshIO Safety Modules provide a reliable solution for developing safety applications in harsh duty environments up to EN 61508 SIL3, PLe according to ISO 13849-1.

HarshIO modules provide inputs and outputs connectivity to safety sensors and actuators – ideal for automotive applications controlling robots into cells as well as complex machine builders.



HarshIO Modules Benefits

- Rugged housing – Module is potted with resin and use metallic connectors
- Compactness design delivers enhanced space savings and simplify retrofit applications
- Extend temperature range from -20° up to +70°C with no electrical derating
- 4-pole and 5-pole power connector versions
- Overmolded memory key - Stores the module's configuration. Speeds up module replacement while eliminating special tools or recommissioning
- Ethernet Media Redundancy (DLR) and daisy-chaining
- USB stick – including safety manual, configuration software, EDS ... - with product package

EtherNet/IP



SNCT - Configuration Software



HarshIO I/O safe capabilities

- TÜV certified: for use in safety applications, up to SIL3 and PLe
- Flexibility: supports connection of single and dual channel safety devices on inputs and outputs
- Individual Test Outputs: each test output can be assigned to a safety input device, allowing for optimized cable installations
- Safe sourcing outputs (1A) or safe bipolar outputs (2A) module versions
- Versatility: can connect to both standard and safety-rated sensors
- Advanced capabilities: reuse Test Outputs for added diagnostics, panel lamps, standard actuators, etc. and connect standard proximity switches, sensors and pushbuttons to unused safety inputs

Fast and easy solution for your HarshIO Safety module commissioning and diagnostic.

Advanced features like online device discovery, copy and paste SNN, Signature to and from RSLogix 5000, safety lock, password protection. SNCT is delivered with the product package.

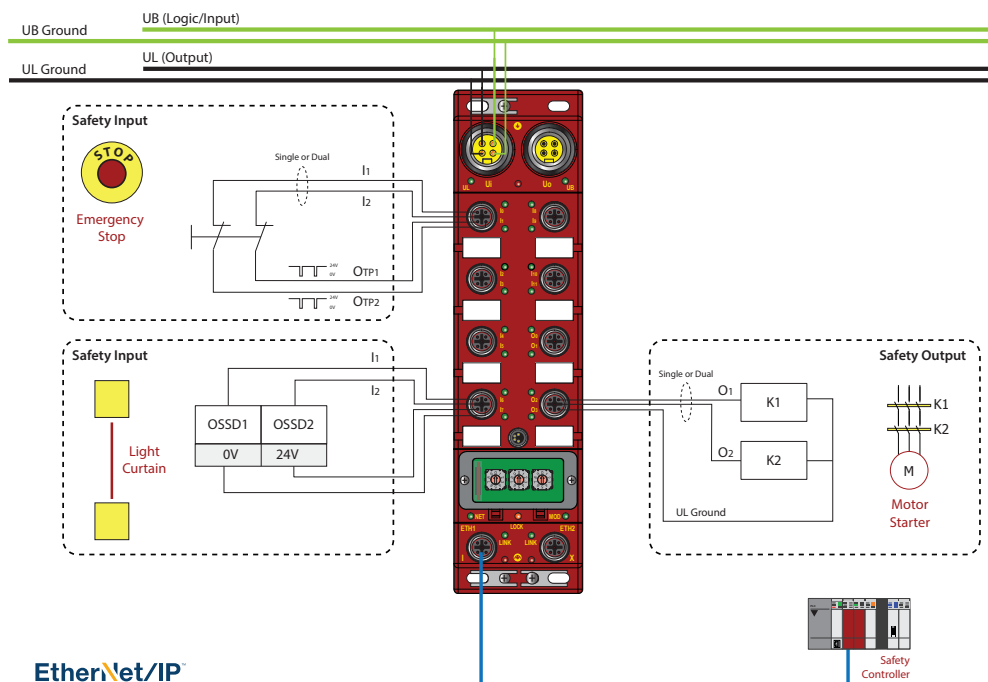

Safety Plug and Play infrastructure solution

To simplify the integration of a high diversity of safety devices, Molex provides a range of Safety Passive components as adapters and splitters, for dedicated manufacturer and wiring standards.

An overview of the solutions available is listed in the Safety Integration Manual of our IO module or can be found on the Molex web site: www.molex.com/link/brad_support.html

Adapters and splitters for dedicated interconnection

Adapter cordsets convert different pinout to the standard Safety HarshIO port configuration through wire crossing or wire bridging.

Splitter cordsets allows to dispatch different signals from sensors to multiple ports or distribute power in case of light curtains.

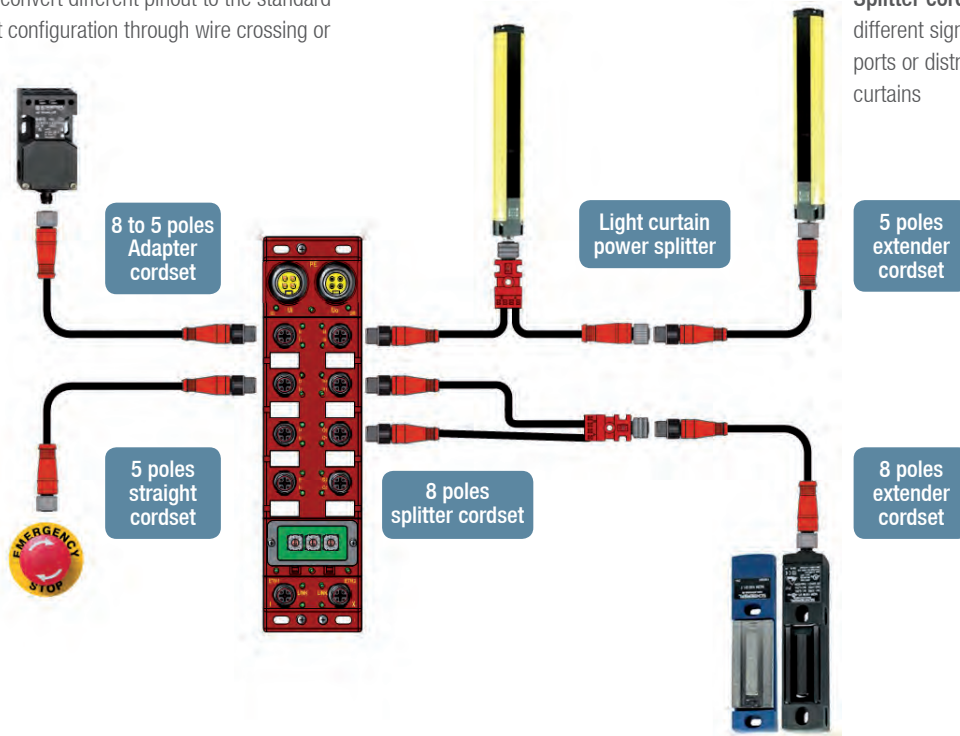

Increase input sensors by serialisation

Safety Tee and **Safety MPIS (Multiport Passive Interconnection Systems)** allow to integrate several sensors in a single safety loop. Different wiring are available according to the safety signals (N.O., N.C., OSSD,...)

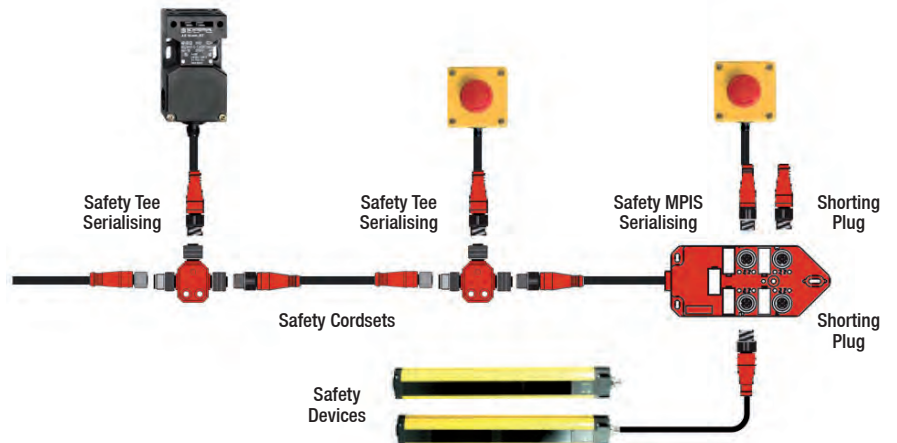

Safe control of multiple output signals

Power supply cordset adapters supply with power further automation equipment or digital outputs signals through one single Safe Output.



Flamar Cable Solutions for industrial automation applications

molex®

Selecting the right cable for your application is very important to ensure a reliable and problem-free installation.

Careful consideration of mechanical abrasion, fluid/chemical exposure, flexibility (C-track, torsion), temperature resistance and flame retardancy requirements is required to select the cable that will provide performance and reliability in service.

Flamar from Molex

Flamar, a Molex company since 2014, proposes a brand new set of cables designed to cover the broadest range of applications for machine builders and system integrators:



- **Signal & Control:** to connect sensors, actuators, valves and distribution boxes
- **Servo Motor:** for power and encoder/resolver connection
- **Network:** for I/O modules and connection to PLC
- **Hybrid:** composite multicore cables whenever extremely compact solution is required

Jacket choice for most demanding industrial application

- **PVC:** The most cost-effective solution for flexible and static installation.
- **WSOR:** Weld-Slag and Oil-Resistant Cable, a single-cable solution designed to withstand the severe environments found in automotive and industrial factory floors. Suitable for drag chain applications.
- **PUR (Polyurethane):** Ensures top mechanical performance, withstands harsh environments, abrasion resistant. PUR Jacket are halogen free. Suitable for drag chain applications
- **TPE:** Cables defined according to the US/Canadian market requirements (UL «PLTC»). Suitable for drag chain application.

3 Packaging Sizes

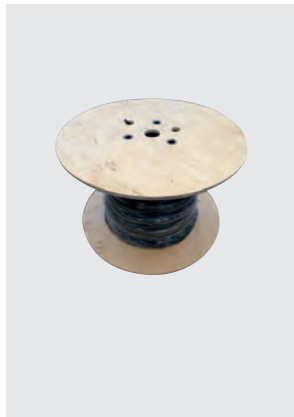
Each application section of the Designer Guide includes the ordering number in Small, Medium and Large cable spool corresponding to the cable code from the Brad® cordset engineering numbers. More cable choice on www.molex.com/link/flamar

Small	Medium	Large
3x100m - 3x200m*	250m - 800m*	500m - 1500m*
3 cardboard reels inside one box	1 plywood reel	1 wooden drum
		

* Depending on cable diameter

Signal & Control



Servo Motor



Network



Hybrid



Weld-Slag and Oil-Resistant (WSOR) – **molex**[®] the single-cable solution



Extended characteristics and resistance

- **Withstands severe conditions in harsh environments:** Weld-slag and oil-resistant outer jacket cable. Meets UL 758/1581 and VDE 472-803/B specifications for harsh environment applications. Hydrolysis resistant (EN50396); UV resistant (UL1581-300h); tear resistant (EN50396)
- **Multiple design options in drag-chain applications:** Highly flexible cables with bend radius specifications of 5x outside diameter for static and 7.5x outside diameter for dynamic and drag chain conditions
- **Wide temperature ranges:** static -40 to +90°C, dynamic -25 to +80°C and drag-chain -5 to +60°C
- **Ensures safety for out-of-the-cabinet use:** Certified flame retardant according to IEC 60332-1, CSA FT1, UL Vertical Flame Test UL21215, UL AWM Style 21215 / CSA
- **ECOLAB compatible** (resistant to detergents, disinfectants and wash down water-jet used in Food & Beverage).



One solution for various applications

- **Available in a large cross-section offering:** 0.25, 0.34, 0.50, 0.75, 1.00, 1.50 and 2,50mm² for use in a variety of applications, from sensors and valves to servo motors and networks.
- **Suitable to a variety of industry-standard connectors:** available over molded with M8, M12, MiniChange(7/8"), M23 standard connectors for quick and reliable installation in the field or to be combined with Molex Field attachable connectors for increased flexibility.
- **Designed for use in multiple markets:** in the automotive and robotic area, from welding to cutting-oil environments, conveying and most machine applications.



Optimized and cost effective connectivity solution

As manufacturer of this cable range, Molex can control quality and cost at every steps of the cordsets production to provide price effective cordsets. Choosing this polyvalent WSOR cable helps also to reduce inventory costs. The WSOR cable can also be purchased raw by Molex for the termination on site.

Flamar Standard Cables for Industrial Automation Brochure



Englisch
987651-3992
Chinese
987651-4141

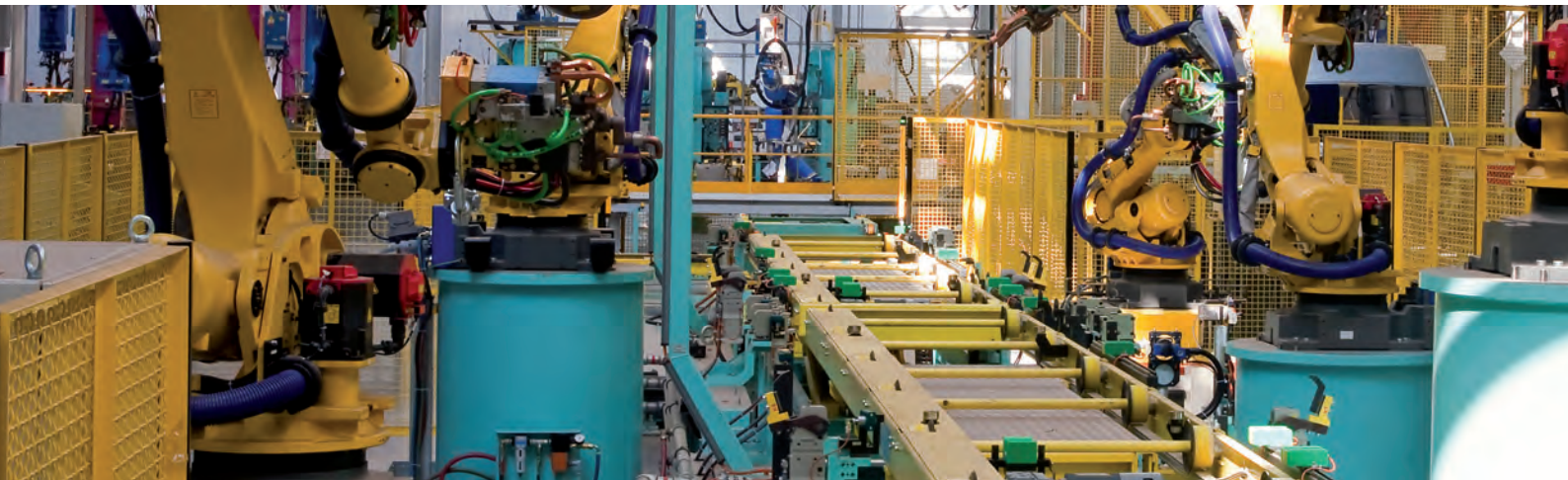

Ethernet and 7/8" Power Distribution Architecture

EtherNet/IP™

PROFI
NET

Modbus
TCP

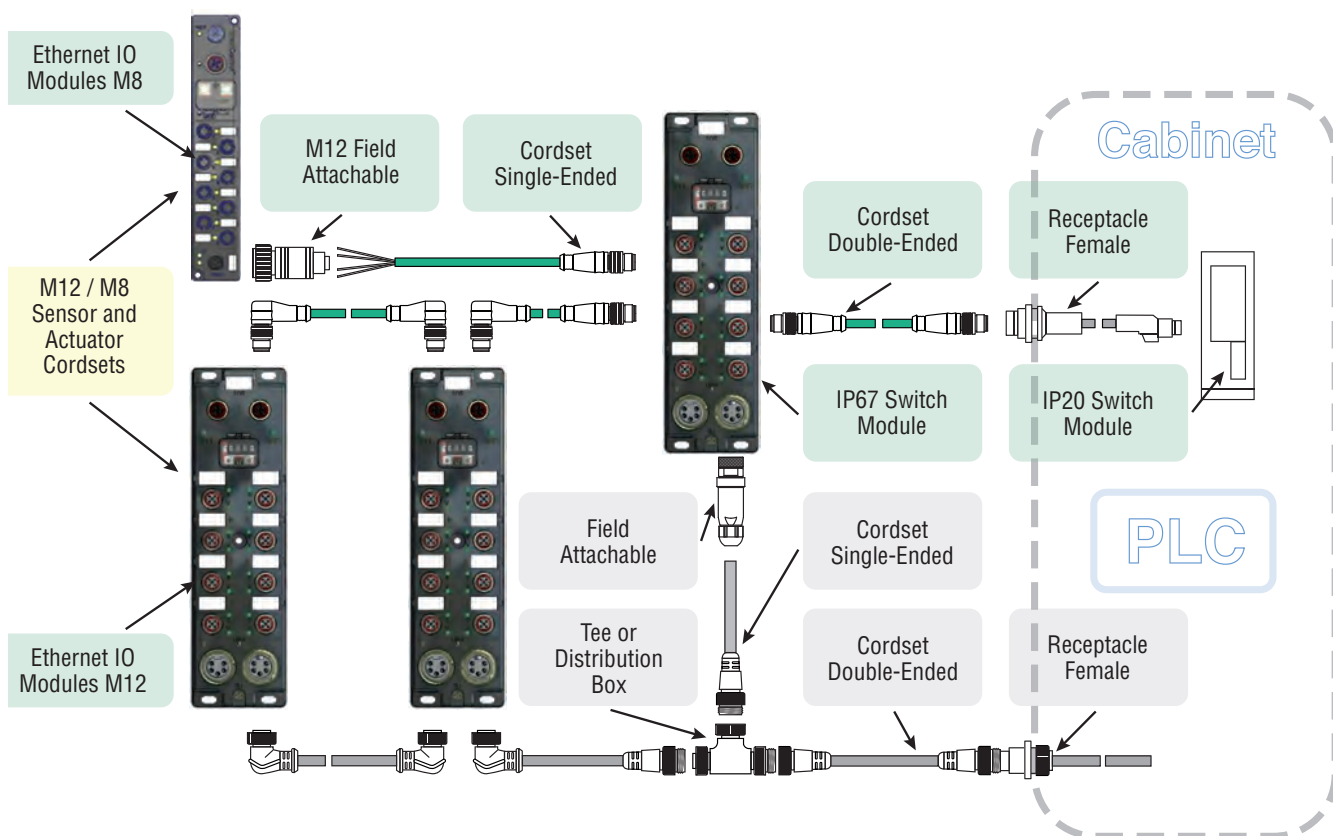



Ethernet Infrastructure components

Ethernet in combination with the industrial protocols like PROFINET or EtherNet/IP provide deterministic behavior for machine and process control applications with only COTS components.

The transition from the fieldbus to the Ethernet communication technologies helps to simplify the industrial infrastructures and enhance the management and maintenance of the devices providing a significant cost saving and performance improvement.

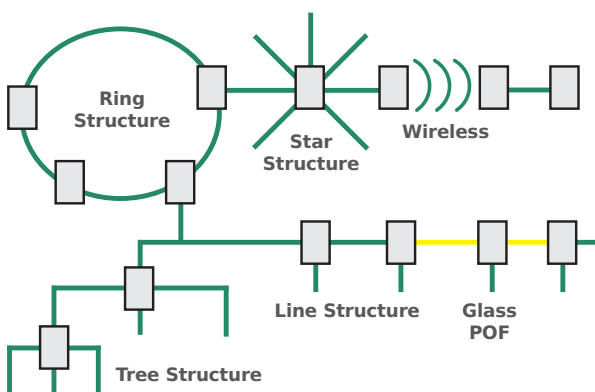

Type of Network

Multi station network
CSMA/CD – Carrier Sense Multiple Access with Collision Detection

Physical Media

Shielded 2 or 4 twisted pairs, AWG22 (PROFINET)
RJ45 or M12 D-Code Connectivity

Network topology

Point to point communication
Star topology with switches
Daisy chain through device integrated
3 ports switches
Ring and redundancy topology protocol dedicated functionalities

Maximum distance

100m between two devices
4 interconnection between 2 devices allowed
No termination required

Power and Communication

Power is supplied separately from network communication

Brad® PROFINET Digital Classic HarshIO Modules

molex®

IP67 rated digital IO modules for harsh environments are designed for direct machine mount applications with PROFINET IO communication capabilities.

Specifications

PROFINET IO-Device, Conformance class B
 IP addressing: DCP or static
 Real-Time I/O update, up to 1 ms
 Services: PROFINergy, SNMP V1/V2/V3, LLDP Send/Rec, MRP, I&M, Easy Device replacement, Fast Start-Up (FSU) < 500ms
 GSDML configuration file (downloadable via integrated Web server)
 Embedded display for diagnostic
 Grounding isolation between Input/logic and Output Power(1)
 Operating Temperature: -25 to 70°C
 Storage Temperature: -40 to +90°C
 Approvals: CE, UL, cUL, Rohs, REACH, PNO Certified

User manual and description files to download under:
www.molex.com/link/brad_support.html



Brad® HarshIO IP67 PROFINET Module 60mm M12

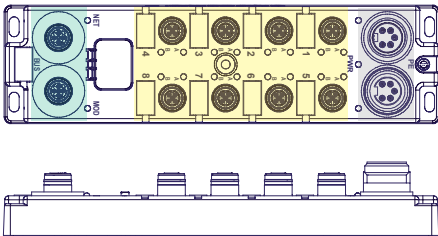

Connectivity

Ethernet:

2x Female M12 4P D-code
 Built-in 2 port switch Ultra-Lock® compatible

Inputs/Outputs:

8x Female M12
 5P A-code Dual IO signal per port Inputs 24V max.
 140mA Outputs 24V max. 2A
 Ultra-Lock® compatible

Power:

1x Male 7/8" 4 or 5 Pole
 1x Fem. 7/8" 4 or 5 Pole
 Voltage: 24V Input 8 Amps

Power Type	Input/Output (PNP)	Engineering No.	Standard Order No.
7/8" 5 Pole	16I	TCDEP-8D0P-D1U-G	112095-5048
	8I/8O	TCDEP-888P-D1U-G	112095-5050
	12I/4O	TCDEP-8B4P-D1U-G	112095-5051
	16O	TCDEP-80DP-D1U-G	112095-5049
	User Config.	TCDEP-8YYX-D1U-01	112095-5115
7/8" 4 Pole ⁽²⁾	16I	TCDEP-8D0P-DYU-G	112095-5052
	8I/8O	TCDEP-888P-DYU-G	112095-5053
	12I/4O	TCDEP-8B4P-DYU-G	112095-5054
	16O	TCDEP-8YYX-DYU-01	112095-5114

(1) Not available on User Configurable IO model

(2) 4 Poles Mini-Change® (7/8") cordsets are not listed in this brochure.
 For more information consult our web page or industrial automation catalog.

Brad® PROFINET Digital Compact HarshIO Modules

molex®

The compact 30mm wide version is designed to be installed in narrow areas, and is perfect for packaging and pick-and-place applications. The lower port count of this model provides a cost-effective module.



Specifications

PROFINET IO-Device, Conformance class B
 IP addressing: DCP or static
 Real-Time I/O update, up to 1 ms
 Services: SNMP V1/V2/V3, LLDP Send/Rec, I&M, Easy Device replacement,
 Fast Start-Up (FSU) < 500ms
 Grounding isolation (1) between Input/logic and Output Power
 Operating Temperature: -25 to 70°C
 Storage Temperature: -40 to +90°C
 Approvals: CE, UL, cUL, Rohs, REACH, PNO Certified



User manual and description files to download under:
www.molex.com/link/brad_support.html

Brad® HarshIO IP67 PROFINET Module – 30mm M8

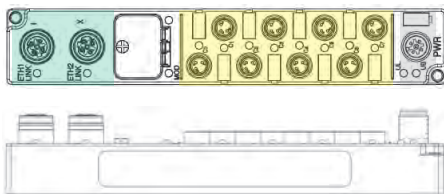

Connectivity

Ethernet: 2x Female M12 4P D-Code Built-in 2 port switch Ultra-Lock® compatible	Inputs/Outputs: 8x Female M8 3 Poles Single IO signal per port Inputs 24V max. 140mA Outputs 24V max. 1,4A	Power: 1x Male M12 5 Pole A-Code Voltage: 24V Input & Output, max. 4 Amps
---	--	--

Power Type	Input/Output (PNP)	Engineering No.	Standard Order No.
M12 5 Pole	8I	TBDEP-880P-D84-G	112095-5064
	4I/4O	TBDEP-844P-D84-G	112095-5065
	8O	TBDEP-808P-D84-G	112095-5066
	User Config.	TBDEP-8YYP-D84	112095-5067

Brad® HarshIO IP67 PROFINET Module – 30mm M12

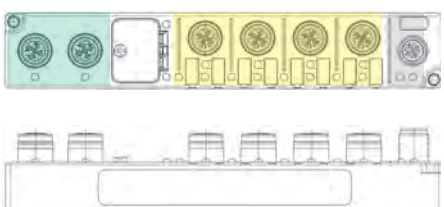

Connectivity

Ethernet: 2x Female M12 4P D-Code Built-in 2 port switch Ultra-Lock® compatible	Inputs/Outputs: 4x Female M12 5P A-Code Dual IO signal per port Inputs 24V max. 140mA Outputs 24V max. 1,4A Ultra-Lock compatible	Power: 1x Male M12 5 Pole A-Code Voltage: 24V Input & Output, max. 4 Amps
---	--	--

Power Type	Input/Output (PNP)	Engineering No.	Standard Order No.
M12 5 Pole	8I	TBDEP-480P-D8U-G	112095-5076
	4I/4O	TBDEP-440P-D8U-G	112095-5077
	8O	TBDEP-408P-D8U-G	112095-5078
	User Config.	TBDEP-4YYP-D8U	112095-5079

(1) Not available on User Configurable IO models.

Brad® PROFINET IO-Link Classic HarshIO Modules



Brad® HarshIO IP67 IO-Link modules brings versatility and cost saving when designing complex machines in harsh environments.

Specifications

- PROFINET IO-Device v2.3 Conformance class B
- 8x IO-Link Master: Port Class A, v1.1 and v1.0 compatible
- 8x IO User Configurable
- IP addressing: DCP or static
- Real-Time I/O update, up to 1ms
- Services: SNMP V1/V2/V3, LLDP Send/Rec, MRP, I&M, Easy Device replacement, Netload: Class 1
- Web server including IO-Link diagnostic
- Inverter input setting per channel (DI)
- Fallback output behavior setting per channel (DO)
- Power supply monitoring (under and over voltage)
- General Diagnostic bit for quick health monitoring
- Operating Temperature: -25 to 70°C
- Storage Temperature: -40 to +85°C
- Approvals: CE, RoHS, REACH, cULus / CSA 22.2, PI Certified



User manual and description files to download under:
www.molex.com/link/brad_support.html

Brad® HarshIO IP67 PROFINET – Module 60mm M12

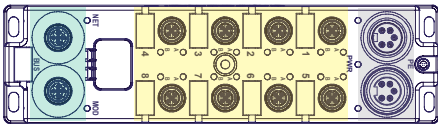

Power Type	Input/Output (PNP)	Engineering No.	Standard Order No.
7/8" 5 Pole	8 IO-Link / 8 User Config.	TCIEP-888P-D1U	112095-5119
7/8" 4 Pole	8 IO-Link / 8 User Config.	TCIEP-888P-DYU	112095-5120

Connectivity

Ethernet: 2x Female M12 4P D-code Built-in 2 port switch Ultra-Lock® compatible	Inputs/Outputs: 8x Female M12 5P A-code Dual IO_Link (Pin4) and IO signal (Pin2) per port Inputs 24V max. 1.6A Outputs 24V max. 2A Ultra-Lock® compatible	Power: 1x Male 7/8" 4 or 5 Pole 1x Fem. 7/8" 4 or 5 Pole Voltage: 24V Input & Output, max. 8 Amps
--	--	---

Brad® EtherNet/IP Digital Classic HarshIO Modules

molex®

IP67 rated digital IO modules for harsh environments are designed for direct machine mount applications with EtherNet/IP communication capabilities.



EtherNet/IP

Specifications

EtherNet/IP Adapter
 IP address: DHCP, Static Address, and 0xF5/0xF6 objects
 Real-Time I/O update, up to 1 ms
 Services: Automatic Conflict Detection (ACD), QuickConnect < 500ms (QC Class A device)
 EDS configuration file (downloadable via CIP File Service)
 Embedded display for diagnostic
 Grounding isolation (1) between Input/logic and Output Power
 Operating Temperature: -25 to +70°C
 Storage Temperature: -40 to +90°C
 Approvals: CE, UL, cUL, Rohs, REACH, ODVA Certified

User manual and description files to download under:
www.molex.com/link/brad_support.html

Brad® HarshIO IP67 EtherNet/IP Module – 60mm M12

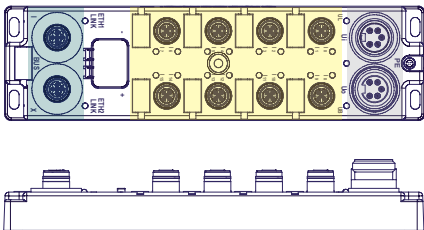

Connectivity

Ethernet:

2x Female M12 4P D-Code
 Built-in 2 port switch
 Ultra-Lock® compatible

Inputs/Outputs:

8x Female M12 5P A-Code
 Dual IO signal per port
 Inputs 24V max. 140mA
 Outputs 24V max. 2A
 Ultra-Lock® compatible

Power:

1x Male 7/8" 4 or 5 Pole
 1x Fem. 7/8" 4 or 5 Pole
 Voltage: 24V Input & Output,
 max. 8 Amps

Power Type	Input/Output (PNP)	Engineering No.	Standard Order No.
7/8" 5 Pole	16I	TCDEI-8D0P-D1U-G	112095-5060
	8I/8O	TCDEI-888P-D1U-G	112095-5061
	12I/4O	TCDEI-8B4P-D1U-G	112095-5063
	16O	TCDEI-80DP-D1U-G	112095-5062
	User Config.	TCDEI-8YYX-D1U-02	112095-5117
7/8" 4 Pole ⁽²⁾	16I	TCDEI-8D0P-DYU-G	112095-5040
	8I/8O	TCDEI-888P-DYU-G	112095-5041
	12I/4O	TCDEI-8B4P-DYU-G	112095-5043
	16O	TCDEI-80DP-DYU-G	112095-5042
	User Config.	TCDEI-8YYX-DYU-02	112095-5116

(1) Not available on User Configurable IO model.

(2) 4 Poles Mini-Change® (7/8") cordsets are not listed in this brochure.
 For more information consult our web page or industrial automation catalog.

Brad® EtherNet/IP CIP Safety Classic HarshIO Modules

molex®

Brad® HarshIO IP67 Modules for EtherNet/IP featuring CIP Safety technology deliver significant operational advantages of protection and versatility for industrial safety applications.

Specifications

EtherNet/IP CIP Safety IO Adapter
 For use in safety applications, up to SIL3 and PLe; Mission time > 20 years
 Real-Time I/O update, up to 10 ms
 Output Bipolar version: max. 2A per dual channel
 Support ODVA CIP Safety I/O generic profiles
 Services: Automatic Conflict Detection (ACD), DLR Client
 EDS upload file (downloadable via CIP File Service)
 Integrated Web server for diagnostics
 IP address: DHCP, Static Address and EtherNet/IP 0xF5/0xF6 objects
 Grounding isolation between Input/logic and Output Power
 Easy commissioning thanks to Molex SNCT software and RA RSLogix™ 5000
 Memory Key for configuration storage: External (M8) or Internal (Window)
 Operating Temperature: -25 to +70°C
 Storage Temperature: -40 to +90°C
 Approvals: CE, UL, cUL, Rohs, REACH, TUV(2), ODVA Certified



EtherNet/IP®



User manual and description files to download under:
www.molex.com/link/brad_support.html

Brad® HarshIO IP67 EtherNet/IP CIP Safety

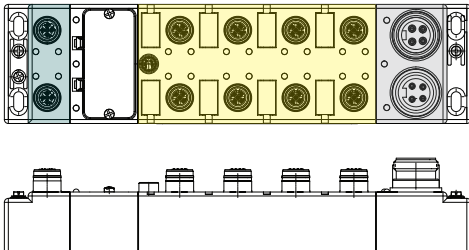

Connectivity

Ethernet:	Inputs/Outputs:	Power:
2x Female M12 4P D-code Built-in 2 port switch Ultra-Lock® compatible	8x Female M12 5P A-Code Dual IO signal per port Inputs 24V max. 140mA Outputs 24V max. 2A Ultra-Lock® compatible	1x Male 7/8" 4 or 5 Pole 1x Fem. 7/8" 4 or 5 Pole Voltage: 24V Input & Output, max. 8 Amps

Power Type	Input/Output (PNP)	Engineering No.	Standard Order No.
with external M8 configuration memory			
7/8" 5 Pole	12I/4O	TCDEC-8B4P-D1U-G8	112095-5129
	12I/4O (Bipolar)	TCDEC-8B4B-D1U-G8	112095-5130
7/8" 4 Pole (1)	12I/4O	TCDEC-8B4P-DYU-G8	112095-5127
	12I/4O (Bipolar)	TCDEC-8B4B-DYU-G8	112095-5128
with internal window configuration memory			
7/8" 5 Pole	12I/4O	TCDEC-8B4P-D1U-GW	112095-5111
	12I/4O (Bipolar)	TCDEC-8B4B-D1U-GW	112095-5112
7/8" 4 Pole (1)	12I/4O	TCDEC-8B4P-DYU-GW	112095-5107
	12I/4O (Bipolar)	TCDEC-8B4B-DYU-GW	112095-5108

(1) 4 Poles Mini-Change® (7/8") cordsets are not listed in this brochure. For more information consult our web page or industrial automation catalog.

Brad® EtherNet/IP MDR Conveyor Classic HarshIO Modules

molex®

Brad™ HarshIO module for roller drives is a unique IP67 solution with on IO ports, dedicated signal interfaces to control out of the cabinet, roller drive behaviors.



Specifications

EtherNet/IP Adapter
 8x Digital Inputs
 4x Digital Outputs (max. 2 Amps)
 4x Analog Outputs (Motor Drive Roller Port)
 IP address: DHCP, Static Address, and 0xF5/0xF6 objects
 Real-Time I/O update, up to 1 ms
 Services: Automatic Conflict Detection (ACD), QuickConnect < 500ms (QC Class A device)
 EDS configuration file (downloadable via CIP File Service)
 Embedded display for diagnostic
 Grounding isolation¹ between Input/logic and Output Power
 Operating Temperature: -25 to +70°C
 Storage Temperature: -40 to +90°C
 Approvals: CE, UL, cUL, Rohs, REACH, ODVA Certified

EtherNet/IP

User manual and description files to download under:
www.molex.com/link/brad_support.html

Brad® HarshIO IP67 EtherNet/IP Module – 60mm M12

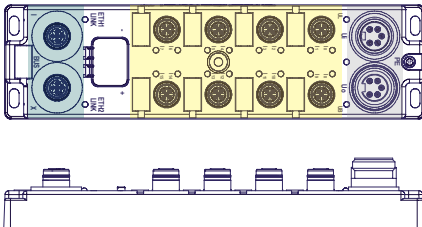

Power Type	Input/Output (PNP)	Engineering No.	Standard Order No.
7/8" 5 Pole	8I/4O/ 4 Motor Drive	TCDEI-88MP-D1U-G	112095-5118

Connectivity

Ethernet: 2x Female, M12, 4P, D-code, Ultra-Lock® compatible Built-in 2 port switch	Inputs/Outputs: 8x Female M12 5P A-code Inputs 24V max. 140mA Outputs 24V max. 2A Ultra-Lock® compatible	Power: 1x Male 7/8" 5 Pole 1x Fem. 7/8" 5 Pole Voltage: 24V Input & Output, max. 9 Amps
--	--	---

Brad® EtherNet/IP IO-Link Classic HarshIO Modules



Brad® HarshIO IP67 IO-Link modules brings versatility and cost saving when designing complex machines in harsh environments.



Specifications

- EtherNet/IP Adapter
- 8x I/O-Link Master: Port Class A, v1.1 and v1.0 compatible
- 8x I/O User Configurable
- IP address via rotary: DHCP, Static Address, and 0xF5/0xF6 objects
- Real-Time I/O update, up to 1ms
- Services: Automatic Conflict Detection (ACD), QuickConnect < 500ms (QC Class A device)
- Web server including IO-Link diagnostic
- Inverter input setting per channel (DI)
- Fallback output behavior setting per channel (DO)
- Power supply monitoring (under and over voltage)
- General Diagnostic bit for quick health monitoring
- Operating Temperature: -25 to 70°C
- Storage Temperature: -40 to +85°C
- Approvals: CE, RoHS, REACH, cULus / CSA 22.2, ODVA Certified



User manual and description files to download under:
www.molex.com/link/brad_support.html

Brad® HarshIO IP67 EtherNet/IP Module – 60mm M12

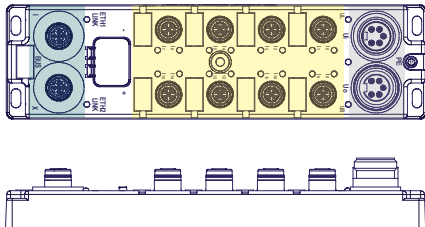

Power Type	Input/Output (PNP)	Engineering No.	Standard Order No.
7/8" 5 Pole	8 IO-Link / 8 User Config.	TCIEI-888P-D1U	112095-5121
7/8" 4 Pole	8 IO-Link / 8 User Config.	TCIEI-888P-DYU	112095-5122

Connectivity

Ethernet:

2x Female M12 4P D-code
 Built-in 2 port switch Ultra-Lock® compatible

Inputs/Outputs:

8x Female M12 5P A-code
 Dual IO_Link (Pin4) and IO signal (Pin2) per port
 Inputs 24V max. 1.6A
 Outputs 24V max. 2A Ultra-Lock® compatible

Power:

1x Male 7/8" 4 or 5 Pole
 1x Fem. 7/8" 4 or 5 Pole
 Voltage: 24V Input & Output,
 max. 8 Amps

Brad® IO-Link HarshIO Devices

molex®

Brad® IO-Link infrastructure accessories are enhancing the I/O count capabilities and the modularity of the Brad® IO-Link HarshIO module.



Specifications

Brad® IO-Link Digital I/O Hubs – 60 mm M12

IO-Link COM3 communication Version 1.1
 Max. Cycle Time: 1ms
 IO-Link process Data length
 Module Current consumption: 40mA
 Max Input current load 100mA (port)
 Max Output current load 0.5A
 UB - Pin 1/3: Power supply for electronics and Inputs
 UL - Pin 2/3: Extended Power supply for outputs or optionally for inputs (configurable)
 Operating temperature: -25 to + 70°C
 Storage temperature: -40 to +90°C
 Approvals: CE, UL, cUL, RohS, REACH



To connect IO-Link Digital I/O Hubs to IO-Link Master HarshIO use standard M12 Sensor/Actuator 4 pole cordsets

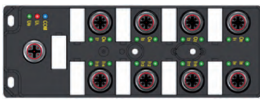

Connectivity

IO-Link: 1x Male M12 5P A-Code Pin4: IO-Link device comm Pin2: Extended power supply	Inputs/Outputs: 8x Female M12 5P A-Code Dual IO signal per port. Inputs 24v, max 100mA Outputs 24V, max 2A
--	---

Input/Output (PNP)	Engineering No.	Standard Order No.
16I	TEDIO-8D0P-808	112103-5000
12I/4O	TEDIO-8B4P-808	112103-5001

Brad® IP67 MODBUS TCP Digital Classic HarshIO Modules

molex®

IP67 rated digital IO modules for harsh environments are designed for direct machine mount applications with Modbus TCP communication capabilities.



Specifications

Modbus TCP server
 Speed: 10/100 Mbps. (auto-negotiation, full duplex)
 Data Access: I/O data
 IP address: DHCP, Static Address
 Embedded display for diagnostic
 Operating Temperature: -25 to +70°C
 Storage Temperature: -40 to +90°C
 Approvals: CE, UL, cUL, Rohs, REACH, Schneider Certified



User manual and description files to download under:
www.molex.com/link/brad_support.html

Brad® HarshIO IP67 Modbus TCP/IP Module – 60mm M12

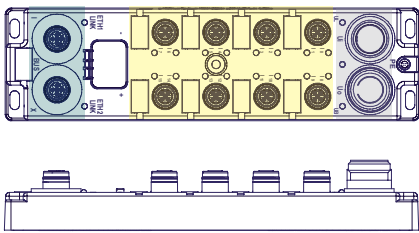

Power Type	Input/ Output	Engineering No.	Standard Order No.
7/8" 5 Pole	User Config.	TCDEM-8YYX-D1U	112095-0009
7/8" 4 Pole ⁽¹⁾	User Config.	TCDEM-8YYX-DYU	112095-5038

(1) 4 Poles Mini-Change® (7/8") cordsets are not listed in this brochure. For more information consult our web page or industrial automation catalog.

Connectivity

Ethernet:

2x Female M12 4P D-Code
 Built-in 2 port switch
 Ultra-Lock® compatible

Inputs/Outputs:

8x Female M12 5P A-Code
 Dual IO signal per port
 Inputs 24V max. 140mA
 Outputs
 24V max. 2A Ultra-Lock®
 compatible

Power:

1x Male 7/8" 4 or 5 Pole
 1x Fem. 7/8" 4 or 5 Pole
 Voltage: 24V Input & Output,
 max. 8 Amps

Brad® Harsh-Duty Ethernet Switches

IP67 rated fast Ethernet switches for harsh environments are designed for direct machine mount applications.

Specifications

Unmanaged IP67 switches
 Speed 10/100Mbps auto negotiation, full or half duplex
 Auto-learning with no software or configuration required
 Operating Temperature: -40 to +75°C
 Storage Temperature: -40 to +90°C
 Approvals: CE, UL, cUL



Brad® Harsh-Duty Unmanaged IP67 Ethernet Switch – 60mm M12

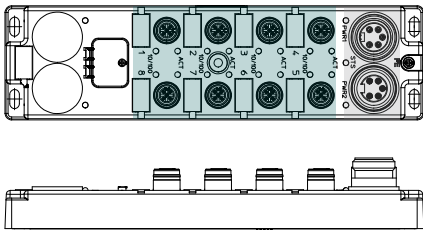

Connectivity

<p>Ethernet: 8x Female M12 4P D-Code Ultra-Lock® compatible</p>	<p>Power: 1x Male 7/8" or 1x Male M12 4 or 5 Pole 1x Fem. 7/8" or 1x Fem. M12 4 or 5 Pole Dual power supply entry, 9-36VDC</p>
--	---

Power Type	Engineering No.	Standard Order No.
7/8" 5 Pole	DRL-780	112105-5002
7/8" 4 Pole	DRL-781	112105-5004
M12 5 Pole	DRL-782	112105-5006

Brad® Harsh-Duty Unmanaged IP67 Ethernet Switch – 30mm M12

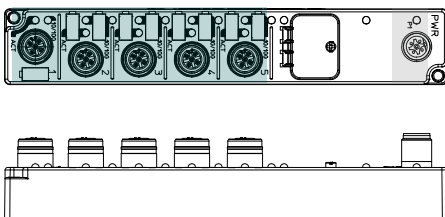

Connectivity

<p>Ethernet: 5x Female M12 4P D-Code</p>	<p>Power: 1x Male M12 5 Pole 9-36VDC</p>
--	---

Power Type	Engineering No.	Standard Order No.
M12 5 Pole	DRL-750	112111-5001

Brad® PROFINET Infrastructure Components



Plug & Play infrastructure to interconnect Ethernet IP67 devices based on D-Code M12 standard connectors.

Brad® PROFINET Single-Ended M12 Cordsets



PROFINET WSOR Cable 12				
	Male Straight		Male 90°	
Length	Engineering No.	Standard Order No.	Engineering No.	Standard Order No.
2m	E10A00612M020	130048-0313	E10A00712M020	130048-0312
5m	E10A00612M050	130048-0295	E10A00712M050	130048-0300
10m	E10A00612M100	130048-0296	E10A00712M100	130048-0301
20m	E10A00612M200	130048-0297	E10A00712M200	130048-0302
30m	E10A00612M300	130048-0298	—	—

PROFINET Type C WSOR Cable 12 Specification

22AWG Shielded PROFINET Cat5e cable

Conductors: 2x2x0,34mm²

(White, Yellow, Blue, Orange)

Jacket material: WSOR Green, flame retardant, oil, UV & Weld Slag resistant, silicone & FCKW free

Diameter: 6,8 +/- 0,2mm

Static Operating Temp: -40 to +80°C

Dynamic Operating Temp: -10 to +70°C

Drag Chain (>2 Mio Cycles)

Approvals: UL AWM Style 21215 / CSA

Brad® PROFINET Double-Ended M12 Cordsets



PROFINET WSOR Cable 12				
	Male to Male Straight		Male to Male 90°	
Length	Engineering No.	Standard Order No.	Engineering No.	Standard Order No.
1m	E11A06012M010	120108-8304	E11A06312M010	120108-0508
2m	E11A06012M020	120108-8305	E11A06312M020	120108-0509
5m	E11A06012M050	120108-8308	E11A06312M050	120108-0510
10m	E11A06012M100	120108-8311	E11A06312M100	120108-0511
15m	E11A06012M150	120108-8313	—	—
20m	E11A06012M200	120108-8315	—	—
30m	E11A06012M300	120108-8317	—	—

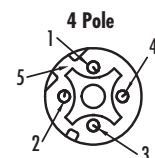

- 1 - Yellow (TD+)
- 2 - White (RD+)
- 3 - Orange (TD-)
- 4 - Blue (RD-)
- 5 - D-Code

Brad® PROFINET M12 Female Receptacle to RJ45



PROFINET WSOR Cable 12		
Length	Engineering No.	Standard Order No.
1m	ERWPAU7012M010	120108-0519
2m	ERWPAU7012M020	120108-0520

Brad® PROFINET Infrastructure Components

molex®



Brad® PROFINET M12 Male to RJ45 adapter cable



PROFINET WSOR Cable 12		
Length	Engineering No.	Standard Order No.
1m	E16A06012M010	120108-0521
2m	E16A06012M020	120108-0522
5m	E16A06012M050	120108-0523
10m	E16A06012M100	120108-0524

Brad® PROFINET RJ45 to RJ45 cable



PROFINET WSOR Cable 12		
Length	Engineering No.	Standard Order No.
0,3	E66A06012M003	120108-8554
0,6	E66A06012M006	120108-8555
1	E66A06012M010	120108-8353
2	E66A06012M020	120108-8354
3	E66A06012M030	120108-8355
5	E66A06012M050	120108-8357
10	E66A06012M100	120108-8361

PROFINET WSOR Cable 12
Raw cable ordering information

Size	Standard Order No.
3x100m	155421-5001
1x500m	155421-5002
1x1000m	155421-5003

This cable can also be used for any other Ethernet communication protocol

ETHERNET
POWERLINK

Ether**CAT**®

MODBUS
TCP

Build-A-Part Number Configuration Code



Brad® EtherNet/IP Infrastructure Components



Plug & Play infrastructure to interconnect Ethernet IP67 devices based on D-Code M12 standard connectors.

EtherNet/IP™

Brad® EtherNet/IP Single-Ended M12 Cordsets



EtherNet/IP WSOR cable 16				
	Male Straight		Male 90°	
Length	Engineering No.	Standard Order No.	Engineering No.	Standard Order No.
2m	E10A00616M020	120108-8542	E10A00716M020	120108-8538
5m	E10A00616M050	120108-8543	E10A00716M050	120108-8539
10m	E10A00616M100	120108-8544	E10A00716M100	120108-8540
20m	E10A00616M200	120108-8545	E10A00716M200	120108-8541
30m	E10A00616M300	120108-8546	-	-

Ethernet WSOR Cable 16 Specification

24AWG Shielded EtherNet/IP Cat5e cable
 Conductors: 2x2x0,25mm²
 (Orange, Orange/White, Green, Green/White)
 Jacket material: WSOR Teal,
 flame retardant, oil, UV & Weld Slag
 resistant, silicone & FCKW free
 Diameter: 7,0 +/-0,2mm
 Static Operating Temp: -40 to +80°C
 Dynamic Operating Temp: -10 to +60°C
 Drag Chain (>2 Mio Cycles)
 Approvals: UL AWM Style 21215 / CSA

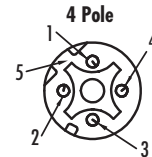

- 1 - White/Orange
- 2 - White/Green
- 3 - Orange
- 4 - Green
- 5 - D-Code

Brad® EtherNet/IP Double-Ended M12 Cordsets



EtherNet/IP WSOR cable 16				
	Male to Male Straight		Male to Male 90°	
Length	Engineering No.	Standard Order No.	Engineering No.	Standard Order No.
1	E11A06016M010	120108-8420	E11A06316M010	120108-8548
2	E11A06016M020	120108-8421	E11A06316M020	120108-8549
5	E11A06016M050	120108-8424	E11A06316M050	120108-8550
10	E11A06016M100	120108-8427	E11A06316M100	120108-8551
15	E11A06016M150	120108-8429	-	-
20	E11A06016M200	120108-8431	-	-
30	E11A06016M300	120108-8435	-	-

Note:

Further technical information, datasheet or drawing can be downloaded from the Molex® website using the ordering part number.

Brad® EtherNet/IP M12 Female Receptacle to RJ45

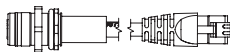

EtherNet/IP WSOR cable 16		
Length	Engineering No.	Standard Order No.
1m	ERWPAU7016M010	120108-8499
2m	ERWPAU7016M020	120108-8500

Brad® EtherNet/IP M12 Male to RJ45 adapter cable



EtherNet/IP WSOR Cable 16		
Length	Engineering No.	Standard Order No.
1m	E16A06016M010	120108-8450
2m	E16A06016M020	120108-8451
5m	E16A06016M050	120108-8454
10m	E16A06016M100	120108-8458



EtherNet/IP WSOR Cable 16
Raw cable ordering information

Size	Standard Order No.
3x100m	155421-6007
1x500m	155421-6008
1x1000m	155421-6009

Brad EtherNet/IP RJ45 to RJ45 cable



EtherNet/IP WSOR Cable 16		
Length	Engineering No.	Standard Order No.
0,3	E66A06016M003	120108-8556
0,6	E66A06016M006	120108-8557
1	E66A06016M010	120108-8474
2	E66A06016M020	120108-8475
3	E66A06016M030	120108-8476
5	E66A06016M050	120108-8478
10	E66A06016M100	120108-8482

Brad® Ethernet M12 X-Code and M8 Infrastructure components



Brad® EtherNet M12 X-Code Cordsets



Length	M12 X-Code to M12 X-Code		M12 X-Code to RJ45	
	Engineering No.	Standard Order No.	Engineering No.	Standard Order No.
1	E22E06020M010	120341-0301	E26E06020M010	1203410501
2	E22E06020M020	120341-0302	E26E06020M020	1203410502
5	E22E06020M050	120341-0305	E26E06020M050	1203410505
10	E22E06020M100	120341-0306	E26E06020M100	1203410506
15	E22E06020M150	120341-0307	-	-
20	E22E06020M200	120341-0308	-	-

Ethernet M12 X-Code cable specification

Shielded CAT6 cable.
 Conductors: 8 conductors 4x2x26AWG
 Jacket material: Green PUR
 Operating Temperature: -40°C to +70°C
 Low halogen Status according IEC60754-1/-2

Brad® EtherNet M12 Female X-Code Receptacle to RJ45



Ethernet RJ45 Adapters		
Length	Engineering No.	Standard Order No.
1	E2RWPAU7021M010	120341-0751
2	E2RWPAU7021M020	120341-0752

Brad® EtherNet M8 Cordsets



M8 Male to Male straight		
Length	Engineering No.	Standard Order No.
1	E44A06020M010	120359-1001
2	E44A06020M020	120359-1002
5	E44A06020M050	120359-1004
10	E44A06020M100	120359-1006
15	E44A06020M150	120359-1008
20	E44A06020M200	120359-1009



Ethernet M8 Connector Pinout

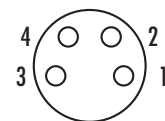

Shielded 4x26AWG Green PUR cable
 Pair1: Pin 1/Pin 4
 Pair2: Pin 2/Pin 3

Brad® Ethernet Infrastructure Accessories

molex

Brad® Ethernet Bulkhead Adapter (M12 Female to RJ45)

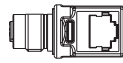
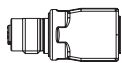

**PROFI[®]
NET**

EtherNet/IP

**MODBUS
TCP**

EtherCAT

**ETHERNET
POWERLINK**

Straight		90°	
Engineering No.	Standard Order No.	Engineering No.	Standard Order No.
ER1PADAPTER	130054-0009	ER1PADAPTER90	130054-0010

Brad® Ethernet Bulkhead Adapter (M12 Female to M12 Female)



M12 to M12 Bulkhead	
Poles	Standard Order No.
4	120084-8170

Brad® Ethernet M12 Field Attachable

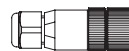
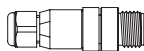

Poles	Cable Size	Wire Gage	Male Straight		Female Straight	
			Engineering No.	Standard Order No.	Engineering No.	Standard Order No.
PROFINET D-Code - Shielded & Screw termination						
4	6.0-8.0	<AWG 18	E1AS06-32	130047-0035	E1AS00-32	130047-0037
PROFINET D-Code - Shielded & IDC termination						
4	4.0-8.0	AWG26-22	E1AS06-53	130047-0039	E1AS00-53	130047-0040
EtherNet X-Code - Shielded & IPC termination						
8	6.5-8.5	<AWG 18	E2AS06-52	120341-0806	-	-

Brad® Ethernet RJ45 Field Attachable



Poles	Cable Size	Wire Gage	Male Straight		Male 90°	
			Engineering No.	Standard Order No.	Engineering No.	Standard Order No.
8	5.5-9.0	AWG24/22	E6AS06-5	130047-8008	E6AS07-5	130047-8009
8	5.5-9.0	AWG26/24	E6AS06-6	130047-8010	E6AS07-6	130047-8011



PROFIBUS and M12 Power Distribution Architecture

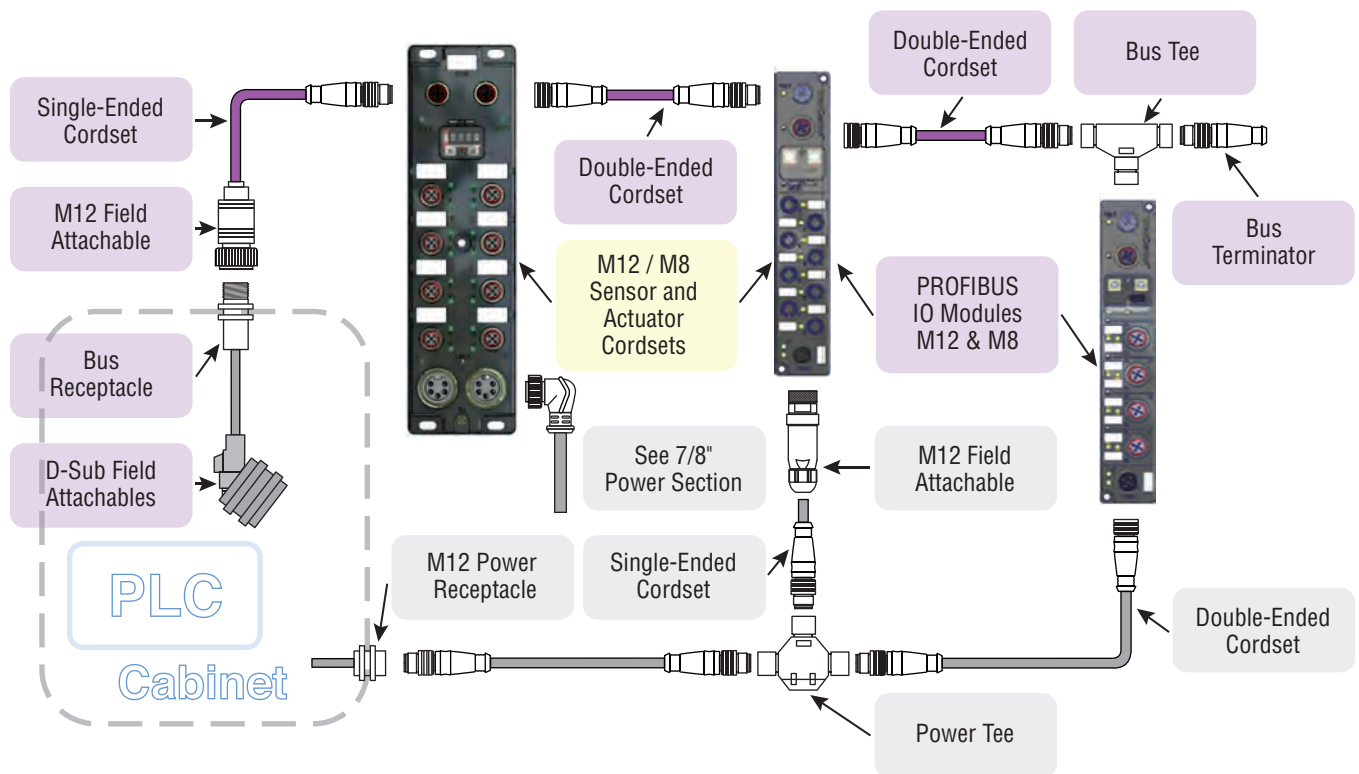



PROFIBUS Infrastructure components

PROFIBUS-DP (Decentralized Periphery) is a device level bus that supports both analog and discrete signals. It permits Mono-master or Multi-master systems, which provides a high degree of flexibility during system configurations.

PROFIBUS allows all automation devices, sensors, actuators, PLC's, etc. to communicate at speeds from 9.6 Kbps to 12 Mbps over distances from 100 to 1,200 meters.

Type of Network

Serial Device Bus – RS485
Cyclic master-slave communication (uses token passing sequence)

Physical Media

Shielded twisted pair, AWG 22.
D-Sub9, M12 B-Code connectivity

Network topology

Bus Topology, no drop line allowed

Maximum Devices

Max. 32 Stations per PROFIBUS segment that can be extended with repeaters to 126 Stations on one bus (maximum of 244 Bytes input and output possible for each slave)

Maximum distance

93.75Kbps and less – 1200 meters
500Kbps – 400 meters
1.5Mbps – 200 meters
12Mbps – 100 meters

Power and Communication

Power is supplied separately from communications bus.

Communication Methods

Peer-to-peer, multicast or cyclic master-slave (uses token passing sequence).

Termination

Terminating resistor on both ends of a segment via the D-Sub integrated resistor or the M12 terminating resistor.

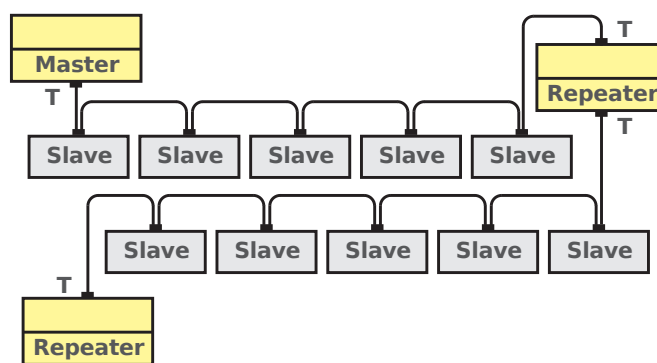

Brad® PROFIBUS Digital Classic HarshIO Modules

molex®

IP67 rated digital IO modules for harsh environments are designed for direct machine mount applications.

Specifications

PROFIBUS DP-V0 Slave according EN 50170
 Auto baud: all baud rates up to 12M Baud
 Address Settings: 1 – 99 by 2 rotary switches
 Operating Temperature: -25 to +70°C
 Storage Temperature: -25 to +90°C
 Approvals: CE, UL, PNO Certification

User manual and description files to download under:
www.molex.com/link/brad_support.html



Brad® HarshIO IP67 PROFIBUS Module – 60mm M12

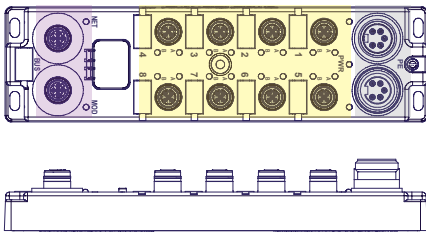

Connectivity

PROFIBUS:

1x Male M12 5P B-Code
 1x Fem. M12 5P B-Code

Inputs/Outputs:

8x Female M12 5P
 A-CodeDual IO signal per port
 Inputs 24V max. 140mA
 Outputs
 24V max. 2A Ultra-Lock® compatible

Power:

1x Male 7/8" 5 Poles
 1x Female 7/8" 5 Poles
 Voltage: 24V Input & Output,
 max. 8 Amps

All Brad® IP67 HarshIO Modules with Micro-Change® (M12) ports accept both threaded cordsets and the new Brad® Ultra-Lock® Connection System, the fastest, easiest and most secure connection ever.



Ultra-Lock® technology is designed for higher performance and reliability to eliminate downtime, increase productivity and lower costs.

Power Type	Input/ Output	Engineering No.	Standard Order No.	
7/8" 5 Pole	NPN	16I	TCDPB-8DON-B1U	112038-0030
		14I/20	TCDPB-8C2N-B1U	112038-0028
		12I/40	TCDPB-8B4N-B1U	112038-0026
		8I/80	TCDPB-888N-B1U	112038-0024
	User Config.	TCDPB-8YYX-B1U	112038-5005	
	PNP	16I	TCDPB-8DOP-B1U	112038-0031
		14I/20	TCDPB-8C2P-B1U	112038-0029
		12I/40	TCDPB-8B4P-B1U	112038-0027
8I/80		TCDPB-888P-B1U	112038-0025	

Brad® PROFIBUS Digital Compact HarshIO Modules

molex®

The compact 30mm wide version is designed to be installed in narrow areas, and is perfect for packaging and pick-and-place applications. The lower port count of this model provides a cost-effective module.



Brad® HarshIO IP67 PROFIBUS Module – 30mm M8

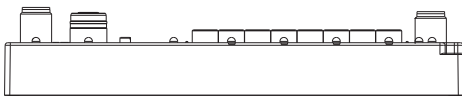
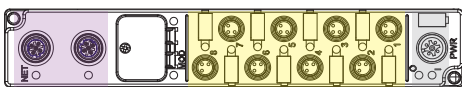

Connectivity

PROFIBUS:

1x Male M12 5 Pole B-Code
1x Fem. M12 5 Pole B-Code

Inputs/Outputs:

8x Female M8
3 Poles
Single IO signal per port
Inputs 24V max. 140mA
Outputs 24V max. 1.4A

Power:

1x Male M12 5 Pole A-Code
Voltage: 24V Input & Output, max. 4 Ampere

Power Type	Input/Output	Engineering No.	Standard Order No.	
M12 5 Pole	NPN	8I	TBDPB-880N-B84	112038-0019
		6I/2O	TBDPB-862N-B84	112038-0017
		4I/4O	TBDPB-844N-B84	112038-0015
	PNP	8I	TBDPB-880P-B84	112038-0021
		6I/2O	TBDPB-862P-B84	112038-0018
		4I/4O	TBDPB-844P-B84	112038-0016
	8O	TBDPB-808P-B84	112038-0014	

Brad® HarshIO IP67 PROFIBUS Module – 30mm M12

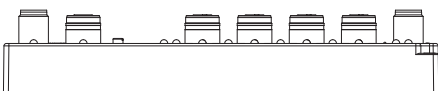
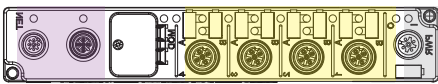

Connectivity

PROFIBUS:

1x Male M12 5 Pole B-Code
1x Fem. M12 5 Pole B-Code

Inputs/Outputs:

4x Female M12 5P A-Code
Dual IO signal per port
Inputs 24V max. 140mA
Outputs 24V max. 1.4A
Ultra-Lock® compatible

Power:

1x Male M12 5 Pole A-Code
Voltage: 24V Input & Output, max. 4 Ampere

Power Type	Input/Output	Engineering No.	Standard Order No.	
M12 5 Pole	NPN	8I	TBDPB-480N-B8U	112038-0009
		6I/2O	TBDPB-462N-B8U	112038-0007
		4I/4O	TBDPB-444N-B8U	112038-0005
	PNP	8I	TBDPB-480P-B8U	112038-0011
		6I/2O	TBDPB-462P-B8U	112038-0008
		4I/4O	TBDPB-444P-B8U	112038-0006
	8O	TBDPB-408P-B8U	112038-0003	

Brad® PROFIBUS Infrastructure Components



Plug & Play PROFIBUS infrastructure to interconnect IP67 devices based on B-Code M12 standard connectors. Designed with PUR jacket material for better chemical and oil resistance, low-resistance contact design and 360° shielded head design to reduce RFI/EMI.



Brad® PROFIBUS Single-Ended M12 Cordsets



PROFIBUS Shielded PUR Cable				
	Male Straight		Male 90°	
Length	Engineering No.	Standard Order No.	Engineering No.	Standard Order No.
2m	B05S06PP4M020	120098-0102	B05S07PP4M020	120098-0109
5m	B05S06PP4M050	120098-0104	B05S07PP4M050	120098-0111
10m	B05S06PP4M100	120098-0107	B05S07PP4M100	120098-0112
20m	B05S06PP4M200	120098-8053	B05S07PP4M200	120098-8054



PROFIBUS Shielded PUR Cable				
	Female Straight		Female 90°	
Length	Engineering No.	Standard Order No.	Engineering No.	Standard Order No.
2m	B05S00PP4M020	120098-0085	B05S01PP4M050	120098-0095
5m	B05S00PP4M050	120098-0087	B05S01PP4M100	120039-0136
10m	B05S00PP4M100	120098-0089	B05S01PP4M200	120098-8056
20m	B05S00PP4M200	120039-0122	B05S01PP4M300	120098-8057

Brad® PROFIBUS Double-Ended M12 Cordsets



PROFIBUS Shielded PUR Cable				
	Female to Male Straight		Female to Male 90°	
Length	Engineering No.	Standard Order No.	Engineering No.	Standard Order No.
1m	BB5S30PP4M010	120098-0006	BB5S33PP4M010	120098-0029
2m	BB5S30PP4M020	120098-0007	BB5S33PP4M020	120098-0031
5m	BB5S30PP4M050	120098-0010	BB5S33PP4M050	120098-0033
10m	BB5S30PP4M100	120098-0014	BB5S33PP4M100	120098-0035
15m	BB5S30PP4M150	120098-0160	BB5S33PP4M150	120098-8050
20m	BB5S30PP4M200	120098-0017	BB5S33PP4M200	120098-8051
30m	BB5S30PP4M300	120098-0019	BB5S33PP4M300	120098-8052

PROFIBUS Cable Specification

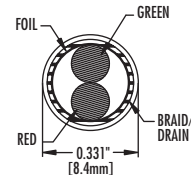

PROFIBUS Twisted Pair AWG22 (0,34mm²) cable

Conductors: 2x Red and Green

Jacket Material: Purple PUR

Voltage Rating: 300V

Operating Temperature: -40 to +60°C

C-Track compatible (3M cycles)

Bend radius: 10x cable diameter

Approvals: UL, CSA

PROFIBUS M12 B-Code Connector Pinout

(front view)

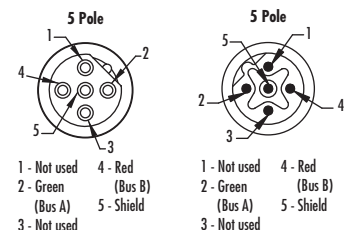

Brad® PROFIBUS Infrastructure Components



Brad® PROFIBUS M12 Receptacles

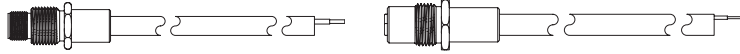

PROFIBUS Shielded PUR Cable				
	Male		Female	
Length	Engineering No.	Standard Order No.	Engineering No.	Standard Order No.
2m	BR5U76PP4M0203	120099-0015	BR5U70PP4M0203	120099-0007
4m	BR5U76PP4M0403	120099-0016	BR5U70PP4M0403	120099-0009



Brad® PROFIBUS M12 Field Attachables



Male		Female	
Engineering No.	Standard Order No.	Engineering No.	Standard Order No.
BA5S06-32	120100-0002	BA5S00-32	120100-0001

Brad® PROFIBUS IP20 Bus Terminators



	With Diagnostic		Without Diagnostic	
Desc.	Engineering No.	Standard Order No.	Engineering No.	Standard Order No.
Straight	MA9D00-42	120103-5001	—	—
90°	PA9D01-42	120103-0001	PA9S01-42	120103-0005
45°	PA9D0B-42	120103-0003	—	—

Brad® PROFIBUS Accessories

PROFIBUS M12 Male Terminator	
Engineering No.	Standard Order No.
B05S06*	120102-0002*



PROFIBUS M12 Bus Tee	
Engineering No.	Standard Order No.
PDTS01*	120101-0002*

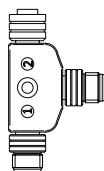

PROFIBUS Terminator Resistor Wiring

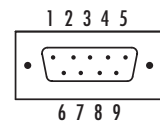

- 1 - Not used
- 2 - Not used
- 3 - Red (Bus B)
- 4 - Not used
- 5 - Not used
- 6 - Not used
- 7 - Not used
- 8 - Green (Bus A)
- 9 - Not used

PROFIBUS Terminator Resistor Wiring

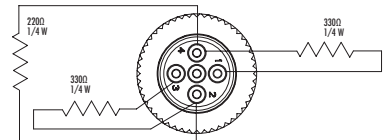

PROFIBUS Tee Wiring

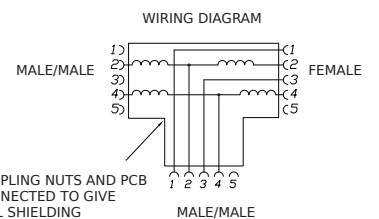

COUPLING NUTS AND PCB CONNECTED TO GIVE FULL SHIELDING

PROFIBUS Max drop lengths

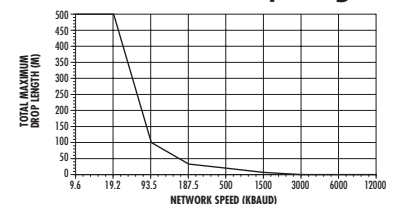



Brad Mini-Change 7/8" for power distribution

Dedicated +24VDC power supply for 60mm HarshIO modules.

- Up to 8 Amps UL per contacts
- 16 AWG Wires (1.5mm²) for low voltage drop
- 5 Poles version

Solution also available as 4 Pole for +24VDC as well as alternative current supply or as 3 Poles for 230VAC + GND.



Brad Micro-Change M12 A-Code for power distribution

Dedicated +24VDC power supply for 30mm HarshIO modules.

- Up to 4 Amps UL per contacts
- 22 AWG Wires (0.34mm²) with 5th wire GR/YE
- 5 Poles version

Take care about voltage drop, available also in larger wire gage.



Brad Micro-Change M12 Power T-Code for power distribution

Dedicated +24VDC power supply.

- Up to 12 Amps UL per contacts
- 16 AWG Wires (1.5mm²)
- 4 Poles version

Solution also available as L-Code or F-Code. Conductors and 16 Amps per contacts.





Power Distribution Components

Further Industrial power connectors from Molex

Brad Power

Dedicated for power distribution and motor control.
Up to 32 Amps per contacts compliant to NFPA-79



Brad M23 / M40

Round and compact IP67 connector mixing Power and signal distribution.
Up to 28 Amps (M23) or 55 Amps (M40)



GWconnect Heavy Duty Connector

Rectangular connector for high density and modular connectivity applications
Up to 100 Amps according to inserts and contacts used.

For more information about these additional connectors from Molex consult our web page.



A graphic for a 'Fast check fold out' featuring a QR code, a phone number, and the Molex logo. The graphic includes the text 'HEAVY DUTY CONNECTORS 3 FOR INDUSTRIAL APPLICATIONS FAST CHECK' and 'GWconnect molex'.

Fast check fold out

987651-4521



Brad® Mini-Change® 7/8" Auxiliary Power Infrastructure Components

molex

Plug & Play 5 Pole power distribution infrastructure to interconnect IP67 devices based on the 7/8" standard connectors also called Mini-Change®.

Brad® Mini-Change® Single-Ended 5 Pole Cordsets

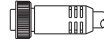

B35 WSOR Cable				
	Male Straight		Female Straight	
Length	Engineering No.	Standard Order No.	Engineering No.	Standard Order No.
2m	105006B35M020	130006-8159	105000B35M020	130006-8164
5m	105006B35M050	130006-8160	105000B35M050	130006-8165
10m	105006B35M100	130006-8161	105000B35M100	130006-8166
20m	105006B35M200	130006-8162	105000B35M200	130006-8167
30m	105006B35M300	130006-8163	105000B35M300	130006-8168

B35 WSOR Cable Specification*

Conductors: 5 x 16 AWG (1.5mm²)
 Brown, White, Blue, Black, Yellow/Green
 Jacket Material: WSOR, Light grey, not halogen free, flame retardant, oil resistant
 Voltage Rating: 600V
 Static Operating Temp: -40 to +90°C
 Dynamic Operating Temp: -25 to +80°C
 C-Track and Torsion Flex Rated
 (>5Mio Cycles)
 Approvals: UL AWM Style 21215 / CSA

Brad® Mini-Change® Double-Ended 5 Pole Cordsets

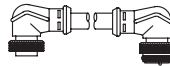
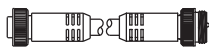

B35 WSOR Cable				
	Female to Male Straight		Female to Male 90°	
Length	Engineering No.	Standard Order No.	Engineering No.	Standard Order No.
1m	115030B35M010	130010-8044	115033B35M010	130010-8051
2m	115030B35M020	130010-8045	115033B35M020	130010-8052
3m	115030B35M030	130010-8046	115033B35M030	130010-8053
5m	115030B35M050	130010-8047	115033B35M050	130010-8054
10m	115030B35M100	130010-8048	115033B35M100	130010-8055
15m	115030B35M150	130010-8049	115033B35M150	130010-8056
20m	115030B35M200	130010-8050	115033B35M200	130010-8057



Raw cable ordering information

Size	Standard Order No.
1x200m	155220-0238
1x500m	155220-0239
1x1000m	155220-0240

* Also available with PVC (A01) or PUR (B21) jacket

Brad® Mini-Change® 5 Pole Receptacles

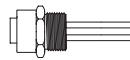
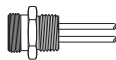

PVC Wires				
	Male Receptacle		Female Receptacle	
Length	Engineering No.	Standard Order No.	Engineering No.	Standard Order No.
1m	1R5006A80M010	130013-8078	1R5000A80M010	130013-8076
2m	1R5006A80M020	130013-8079	1R5000A80M020	130013-8077

Description	Engineering No.	Standard Order No.
Gasket for Receptacle, 1/2"	00-5087	130180-0059
Locknut for Receptacle, 1/2" 14NPT	30-1100	130184-0031

Brad® Mini-Change® 7/8" Auxiliary Power Infrastructure Components

molex®



Brad® Mini-Change® 5 Pole Field Attachable Connector

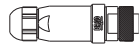

Male		Female	
Engineering No.	Standard Order No.	Engineering No.	Standard Order No.
1A5006-34	130017-0029	1A5000-34	130017-0023

Brad® Mini-Change® 5 Pole Tees

Mini-Change® Tee	
Engineering No.	Standard Order No.
DN3020	130035-0057

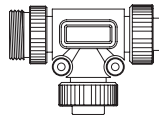

Mini-Change® Y-Splitter	
Engineering No.	Standard Order No.
DN3200	130035-0071

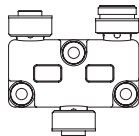

Mini-Change® Tee w/M12 Drop	
Engineering No.	Standard Order No.
DND3020	130039-0341

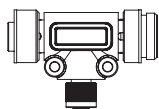

Mini-Change® Distribution Box		
Description	Engineering No.	Standard Order No.
4 Ports	DN4000	130036-0005
6 Ports	DN6000	130036-0008

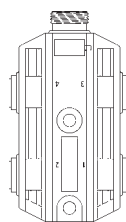

Brad® Mini-Change® Accessories

Mini-Change® Caps		
Description	Engineering No.	Standard Order No.
Int. Thread	65-0086	130201-1111
Ext. Thread	65-0085	130201-1109

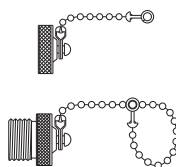

Mini-Change® 5 Pole Female Connector Pinout

(Front view)

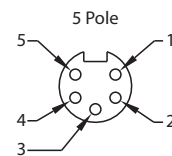

- 1. Black – Output Power V-
- 2. Blue – Bus Power V-
- 3. Green/Yellow – Ground
- 4. Brown – Bus Power V+
- 5. White – Output Power V+

5 Pole Mini-Change® Tee, Y-Splitter and Distribution Box Wiring

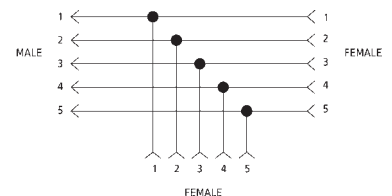

Note:

Further technical information, datasheet or drawing can be downloaded from the Molex® website using the Standard Order part number listed.

Brad® M12 A-Code Auxiliary Power Infrastructure Components

molex

Plug & Play 5 Pole power distribution infrastructure to interconnect IP67 devices based on the A-Code M12 standard connectors.

Brad® Micro-Change® M12 Single-Ended 5 Pole Cordsets



B42 WSOR Cable				
	Male Straight		Male 90°	
Length	Engineering No.	Standard Order No.	Engineering No.	Standard Order No.
2m	805006B42M020	120065-2280	805007B42M020	120065-2292
5m	805006B42M050	120065-2281	805007B42M050	120065-2293
10m	805006B42M100	120065-2282	805007B42M100	120065-2294
20m	805006B42M200	120065-9546	805007B42M200	120065-9545
30m	805006B42M300	120065-9547	—	—



B42 WSOR Cable				
	Female Straight		Female 90°	
Length	Engineering No.	Standard Order No.	Engineering No.	Standard Order No.
2m	805000B42M020	120065-2256	805001B42M020	120065-2268
5m	805000B42M050	120065-2257	805001B42M050	120065-2269
10m	805000B42M100	120065-2258	805001B42M100	120065-2270
20m	805000B42M200	120065-9543	805001B42M200	120065-9542
30m	805000B42M300	120065-9544	—	—

Brad® Micro-Change® M12 Auxiliary Power 5 Pole Receptacles



PVC Wires				
	Male		Female	
Length	Engineering No.	Standard Order No.	Engineering No.	Standard Order No.
2m	8R5E36E03M020	120070-8173	8R5E30E03M020	120070-8171
3m	8R5E36E03M030	120070-8174	8R5E30E03M030	120070-8172

B42 WSOR cable Specification*

Conductors: 5x0,34 mm²
 (Brown, White, Blue, Black, Green/Yellow)
 Jacket material: WSOR Black, flame retardant, oil, UV & Weld Slag resistant, silicone & FCKW free
 Diameter 5 Pole: 5,5 +-0,2mm
 Voltage Rating: 600V, max 4 Amps
 Static Operating Temp: -40 to +90°C
 Dynamic Operating Temp: -25 to +80°C
 Drag Chain (>5 Mio Cycles) & torsion suitable
 Approvals: UL AWM Style 21215 / CSA



Raw cable ordering information

Size	Standard Order No.
3x200m	155220-0088
1x800m	155220-0089
1x1500m	155220-0090

* Detailed cable specification attached to bulk cable drawings

Brad® M12 A-Code Auxiliary Power Infrastructure Components



Brad® Micro-Change® M12 Auxiliary Power Double-Ended 5 Pole Cordsets



B42 WSOR Cable				
	Female to Male Straight		Female to Male 90°	
Length	Engineering No.	Standard Order No.	Engineering No.	Standard Order No.
1m	885030B42M010	120066-8824	885033B42M010	120066-8955
2m	885030B42M020	120066-8825	885033B42M020	120066-8956
3m	885030B42M030	120066-8826	885033B42M030	120066-8957
5m	885030B42M050	120066-8827	885033B42M050	120066-8958
10m	885030B42M100	120066-8828	885033B42M100	120066-8959
15m	885030B42M150	120065-9548	—	—
20m	885030B42M200	120065-9549	—	—

Brad® Micro-Change® M12 5 Pole Field Attachable



	Male		Female	
Max. Wire Size	Engineering No.	Standard Order No.	Engineering No.	Standard Order No.
3.3-6.6	8A5006-31	120071-0045	8A5000-31	120071-0041
4.1-8.1	8A5006-32	120071-0047	8A5000-32	120071-0043

Brad® Micro-Change® M12 5 Pole Accessories

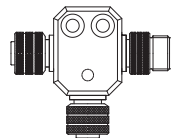
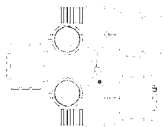

5 Poles M12 Y-Splitter	
Engineering No.	Standard Order No.
0812-05EFJ-0000A	120068-5107

5 Poles M12 Tee	
Engineering No.	Standard Order No.
0812-051FJ-00000	120068-8009

Micro-Change® A-Code M12 5 Pole Auxiliary Power Connector on the IO modules. Female Pinout

(Front view):

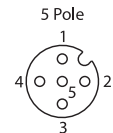

1. Brown – Module Power V+
2. White – Output Power V+
3. Blue – Ground
4. Black – Ground
5. Green/Yellow – Protective Earth

Micro-Change® M12 5 Pole Tee and Y-Splitter Wiring

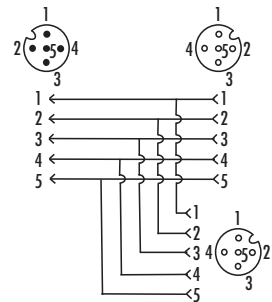

Brad® Micro-Change® M12 Power T-Code Infrastructure Components



Plug & Play 4 Pole power distribution infrastructure based on the T-Code M12 standard connectors for up to 12 Amps per contacts.

Brad® Micro-Change® M12 Power T-Code, Single Ended Cordsets



B43 WSOR Cable				
	Male Straight		Female Straight	
Length	Engineering No.	Standard Order No.	Engineering No.	Standard Order No.
1m	TOP4006B43M010	120500-0017	TOP4000B43M010	120500-0021
2m	TOP4006B43M020	120500-0018	TOP4000B43M020	120500-0022
5m	TOP4006B43M050	120500-0019	TOP4000B43M050	120500-0023
10m	TOP4006B43M100	120500-0020	TOP4000B43M100	120500-0024

Brad® Micro-Change® M12 Power T-Code, Double Ended Cordsets



B43 WSOR Cable		
	Female to Male Straight	
Length	Engineering No.	Standard Order No.
1m	TTP4030B43M010	120501-0009
2m	TTP4030B43M020	120501-0010
5m	TTP4030B43M050	120501-0011
10m	TTP4030B43M100	120501-0012

Brad® Micro-Change® M12 Power T-Code, Receptacles



PVC Wires				
	Male		Female	
Length	Engineering No.	Standard Order No.	Engineering No.	Standard Order No.
0,5m	-	120502-0010	-	120502-0008
1m	-	120502-0011	-	120502-0009

B43 WSOR Cable Specification

Conductors: 4 x 16 AWG (1.5mm²)
 Brown, White, Blue, Black
 Jacket Material: WSOR, Black, not halogen free, flame retardant, oil resistant
 Voltage Rating: 600V
 Static Operating Temp: -40 to +90°C
 Dynamic Operating Temp: -25 to +80°C
 C-Track and Torsion Flex Rated (>5Mio Cycles)
 Approvals: UL AWM Style 21215 / CSA



Raw cable ordering information

Size	Standard Order No.
3x100m	155220-0223
1x500m	155220-0224
1x1000m	155220-0225

Brad® M12 T-Code Auxiliary Power Infrastructure Components



Brad® Micro-Change® M12 Power T-Code, Field Attachable connectors



Male		Female	
Engineering No.	Standard Order No.	Engineering No.	Standard Order No.
TAP4006-33	120503-0002	TAP4000-33	120503-0001

Brad® Micro-Change® M12 Power T-Code, Y-Splitter

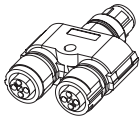

5 Poles M12 Y-Splitter	
Engineering No.	Standard Order No.
TVP4-YMF-000	120504-0001

Micro-Change® M12 T-Code Female connector pinout

(Front view):



- 1. Brown
- 2. White
- 3. Blue
- 4. Black

M12 T-Code Splitter wiring

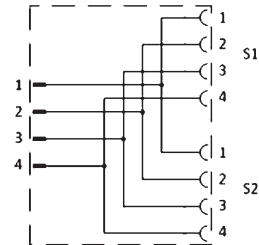



M12 Sensor Actuator Interconnection

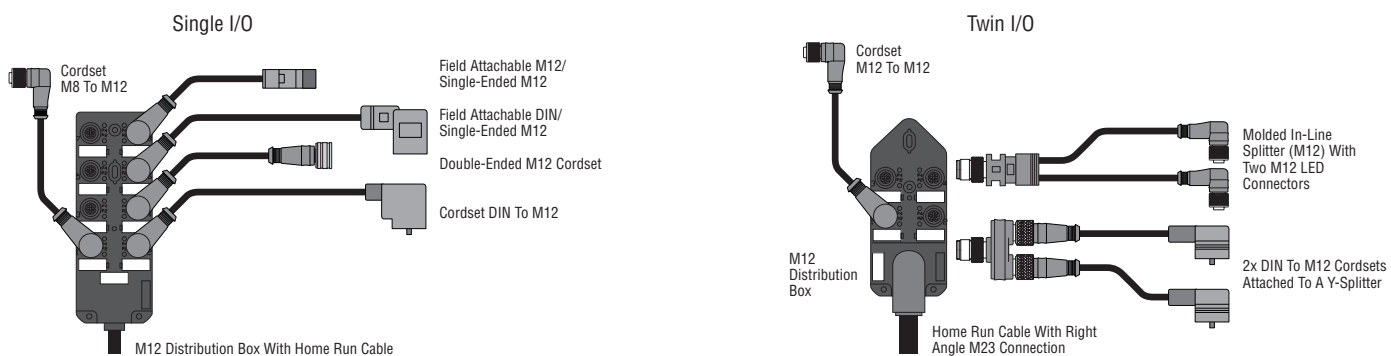

M8 Sensor Actuator Interconnection

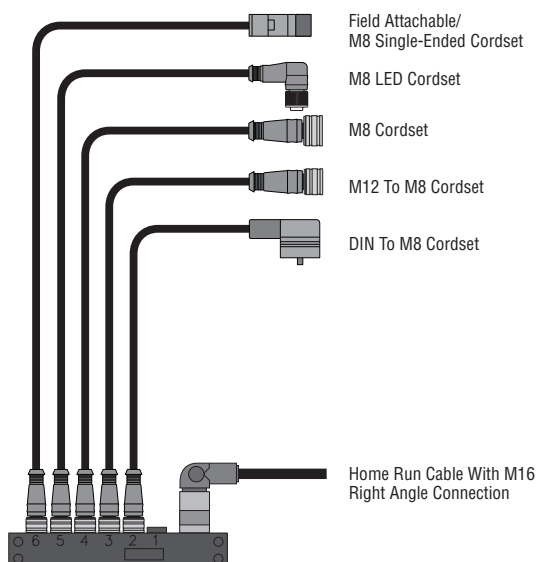



Sensors and Actuators Wiring

Further Industrial power connectors from Molex

Brad® Multi-Port Interconnection Systems (MPIS)

Solution to reduce Installation time and costs through:

- IP67 protection can be installed directly on the machine, close to the automation devices keeping single wiring distances low.
- Concentrate sensor and actuator signals and distribute the Power supply reducing homerun cable dimensions.
- Signal diagnostic information to quickly detect machine states and failures on devices.
- Home run cable termination via an M16/M23 connector, via field terminated screw terminal for installation flexibility or for cost savings directly mounted on the module.

MPIS Applications

MPIS solutions are ideal in case of small or mid size machines. Larger Machines or higher IO counts may prefer the active networked HarshIO modules.

Single and Dual signal ports

Brad MPIS and Active HarshIO I/O Ports can manage up to 2 signals per ports (Twin I/O).

Signals are concentrate on Twin I/O ports:

- By using Splitter cordsets
 - By using Yies or Tees
- as shown in above draft.

Primary signal (from device A) will be on Pin 4
Secondary signal (from device B) will be on Pin 2
As displayed bellow.



Brad® MPIS® Sensor/Actuator Distribution Boxes



IP67 rated passive IO module for harsh environments are designed to concentrate the sensor/actuator signals into one unique home run cable for a better mechanical infrastructure wiring on the machine.

Specifications

IP67 Molded PBT Housing, color Black
 Single or Dual Input/Output signal per port
 Indicating LED for Power and sensor trigger
 PNP Version (available also in NPN version)
 Electrical: 10-30V DC max. & 12.0A max. (4.0A max. per port) Approvals: UL, CSA, IP67, NEMA 6



Brad® M12 Distribution Boxes with PUR Home Run Cable

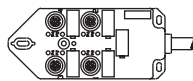

IO Type	Length	4 Ports		8 Ports	
		Engineering No.	Standard Order No.	Engineering No.	Standard Order No.
Single IO	5m	BTB400P-FBW-05	120248-0004	BTB800P-FBW-05	120248-0022
	10m	BTB400P-FBW-10	120248-0005	BTB800P-FBW-10	120248-0023
Dual IO	5m	BTB405P-FBW-05	120248-0031	BTB805P-FBW-05	120248-0049
	10m	BTB405P-FBW-10	120248-0032	BTB805P-FBW-10	120248-0050

Brad® M12 Distribution Boxes with Field Attachable Terminals

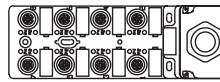
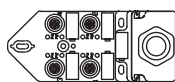

IO Type	4 Ports		8 Ports	
	Engineering No.	Standard Order No.	Engineering No.	Standard Order No.
Dual IO	BTB403P-FBA	120248-0085	BTB803P-FBA	120248-0087

Brad® M12 Distribution Boxes with M23 Connector and Home Run Cable

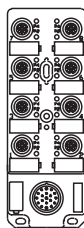
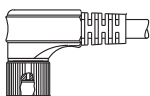

IO Type	8 Ports	
	Engineering No.	Standard Order No.
Single IO	BTB801P-FBC	120248-0060
Dual IO	BTB803P-FBC	120248-0066

Length	Single IO Home Run Cable (12p/11 wires)		Dual IO Home Run Cable (19p/19 wires)	
	Engineering No.	Standard Order No.	Engineering No.	Standard Order No.
10m	K02101B80M100*	120094-8150	K03001B80M100*	120094-8163

*Home run cable also available in 1m, 5m, 15m, 20m, 30m and also with m23 straight connector.

Micro-Change® M12 Single IO Connector Wiring

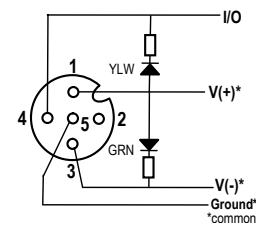

Micro-Change® M12 Dual IO Connector Wiring

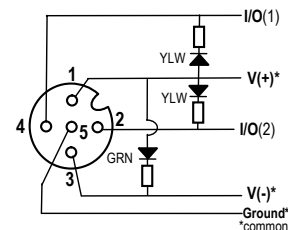

Brad® MPIS® Sensor/Actuator Distribution Boxes

molex®

Brad® M8 Distribution Boxes with Side Mount PUR Home Run Cable



IO Type	Length	4 Ports		6 Ports	
		Engineering No.	Standard Order No.	Engineering No.	Standard Order No.
Single IO	5m	BEB401P-FBW-05	120247-0001	BEB601P-FBW-05	120247-0040
	10m	BEB401P-FBW-10	120247-0002	BEB601P-FBW-10	120247-0041

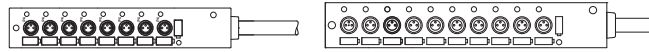

IO Type	Length	8 Ports		10 Ports	
		Engineering No.	Standard Order No.	Engineering No.	Standard Order No.
Single IO	5m	BEB801P-FBW-05	120247-0012	BEBA01P-FBW-05	120247-0006
	10m	BEB801P-FBW-10	120247-0013	BEBA01P-FBW-10	120247-0007

Brad® M8 Distribution Boxes with M16 Connector and Home Run Cable

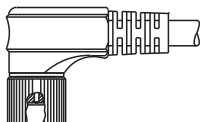
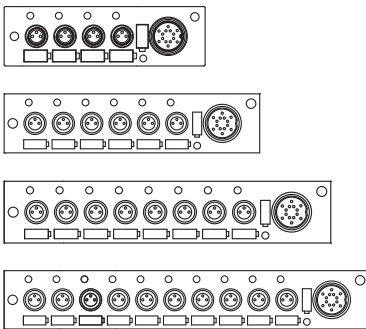

Single IO Distribution Box with M16 connector		
Ports	Engineering No.	Standard Order No.
4	BNB401P-FBC	120247-0059
6	BNB601P-FBC	120247-0061
8	BNB801P-FBC	120247-0063
10	BNBA01P-FBC	120247-0065

M16 Single IO Home Run Cable 10 Meter		
Block	Engineering No.	Standard Order No.
4 Ports	L04301B78M100*	130023-8011
6 Ports	L04201B78M100*	130023-8017
8 Ports	L04101B78M100*	130023-8023
10 Ports	L04A01B78M100*	130023-8029

*Home run cable also available in 5m and 15m length.



Nano-Change® M8 Single IO Connector Wiring

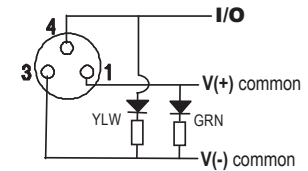

WSOR raw cable ordering information

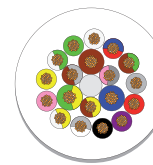

Black
Pink
Yellow
Green
White
Gray
Red
Violet
Blue
Brown

Gray / White
Yellow / White
Green / White Gray
Blue / Red
Brown / Green
Yellow / Brown
Yellow / Green
Gray / Brown
Gray / Pink

Wires	Size	Standard Order No.
3xAWG19 + 16xAWG22	1x100m	155220-9019
	1x500m	155220-9020
	1x1000m	155220-9021

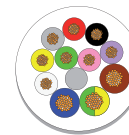

White
Yellow
Gray
Red
Black
Violet

Brown
Yellow / Green
Blue
Green
Pink

Wires	Size	Standard Order No.
3xAWG19 + 8xAWG22	1x100m	155220-9013
	1x500m	155220-9014
	1x1000m	155220-9015

Note:

Further technical information, datasheet or drawing can be downloaded from the Molex® website using the ordering part number.

Brad® Micro-Change® M12 Sensor/Actuator Connectivity



Brad® Micro-Change® M12 connectivity is a ready-to-use solution based on the A-Code M12 standard with IP67/68 rating to wire a wide range of sensors and actuators from proximity switches to rotary encoders in harsh environments.



Brad® Micro-Change® M12 Single-Ended Cordsets



B30 WSOR Cable									
		Female Straight		Female 90°		Male Straight		Male 90°	
Poles	Length	Engineering No.	Standard Order No.	Engineering No.	Standard Order No.	Engineering No.	Standard Order No.	Engineering No.	Standard Order No.
3	1m	803000B30M010	120065-2247	803001B30M010	120065-2259	803006B30M010	120065-2271	803007B30M010	120065-2283
	2m	803000B30M020	120065-2248	803001B30M020	120065-2260	803006B30M020	120065-2272	803007B30M020	120065-2284
	5m	803000B30M050	120065-2249	803001B30M050	120065-2261	803006B30M050	120065-2273	803007B30M050	120065-2285
	10m	803000B30M100	120065-2250	803001B30M100	120065-2262	803006B30M100	120065-2274	803007B30M100	120065-2286
4	1m	804000B30M010	120065-2251	804001B30M010	120065-2263	804006B30M010	120065-2275	804007B30M010	120065-2287
	2m	804000B30M020	120065-2252	804001B30M020	120065-2264	804006B30M020	120065-2276	804007B30M020	120065-2288
	5m	804000B30M050	120065-2253	804001B30M050	120065-2265	804006B30M050	120065-2277	804007B30M050	120065-2289
	10m	804000B30M100	120065-2254	804001B30M100	120065-2266	804006B30M100	120065-2278	804007B30M100	120065-2290
5	1m	805000B30M010	120065-9518	805001B30M010	120065-9522	805006B30M010	120065-9526	805007B30M010	120065-9530
	2m	805000B30M020	120065-9519	805001B30M020	120065-9523	805006B30M020	120065-9527	805007B30M020	120065-9531
	5m	805000B30M050	120065-9520	805001B30M050	120065-9524	805006B30M050	120065-9528	805007B30M050	120065-9532
	10m	805000B30M100	120065-9521	805001B30M100	120065-9525	805006B30M100	120065-9529	805007B30M100	120065-9533
8	1m	808000B41M010	120065-2306	808001B41M010	120065-2310	808006B41M010	120065-2302	808007B41M010	120065-2314
	2m	808000B41M020	120065-9458	808001B41M020	120065-2311	808006B41M020	120065-9453	808007B41M020	120065-2315
	5m	808000B41M050	120065-2308	808001B41M050	120065-2312	808006B41M050	120065-2304	808007B41M050	120065-2316
	10m	808000B41M100	120065-9463	808001B41M100	120065-2313	808006B41M100	120065-2305	808007B41M100	120065-2317

Build-A-Part Number Configuration Code

	Poles	Cable	Code
0.34mm ²	3, 4, 5	PVC	E03
		WSOR	B30
		PUR	H09
0.25mm ²	8	PVC	E02
		WSOR	B41
		PUR	H08

803000

B30

M020

H

ID Tag Option

↑

↓

Cable Length

M020 for 2m

Brad® Micro-Change® M12 Sensor/Actuator Connectivity



Brad® Micro-Change® M12 Double-Ended Cordsets



B30 WSOR Cable					
Poles	Length	Female To Male Straight		Female 90° To Male Straight	
		Engineering No.	Standard Order No.	Engineering No.	Standard Order No.
3	0.6m	883030B30M006	120066-8889	883031B30M006	120066-8877
	1m	883030B30M010	120066-8890	883031B30M010	120066-8878
	2m	883030B30M020	120066-8891	883031B30M020	120066-8879
	3m	883030B30M030	120066-8892	883031B30M030	120066-8880
	5m	883030B30M050	120066-8893	883031B30M050	120066-8881
	10m	883030B30M100	120066-8894	883031B30M100	120066-8882
4	0.6m	884030B30M006	120066-8817	884031B30M006	120066-8829
	1m	884030B30M010	120066-8818	884031B30M010	120066-8830
	2m	884030B30M020	120066-8819	884031B30M020	120066-8831
	3m	884030B30M030	120066-8820	884031B30M030	120066-8832
	5m	884030B30M050	120066-8821	884031B30M050	120066-8833
	10m	884030B30M100	120066-8822	884031B30M100	120066-8834
5	0.6m	885030B30M006	120066-8991	885031B30M006	120066-8997
	1m	885030B30M010	120066-8992	885031B30M010	120066-8998
	2m	885030B30M020	120066-8993	885031B30M020	120066-8999
	3m	885030B30M030	120066-8994	885031B30M030	120066-9000
	5m	885030B30M050	120066-8995	885031B30M050	120066-9001
	10m	885030B30M100	120066-8996	885031B30M100	120066-9002
8	0.6m	888030B41M006	120066-8895	888031B41M006	120066-8883
	1m	888030B41M010	120066-8896	888031B41M010	120066-8884
	2m	888030B41M020	120066-8897	888031B41M020	120066-8885
	3m	888030B41M030	120066-8898	888031B41M030	120066-8886
	5m	888030B41M050	120066-8899	888031B41M050	120066-8887
	10m	888030B41M100	120066-8900	888031B41M100	120066-8888

B30 WSOR Cable Specification*

Conductors: 3x0,34 mm², 4x0,34 mm² or 5x0,34 mm² **

(Brown, White, Blue, Black, Grey)

Jacket material: Black WSOR, flame retardant, oil, UV & Weld Slag resistant, silicone & FCKW free

Diameter 3 Pole: 4,8 +-0,2mm

Diameter 4 Pole: 5,1 +-0,2mm

Diameter 5 Pole: 5,5 +-0,2mm

Voltage Rating: 600V

Static Operating Temp: -40 to +90°C

Dynamic Operating Temp: -25 to +80°C

Drag Chain (>5 Mio Cycles) & torsion suitable

Approvals: UL AWM Style 21215 / CSA

* Detailed cable specification attached to bulk cable drawings
 ** 8 pole cable specification: see B41 description in M8 section

Brad® Micro-Change® M12 Front Mount Receptacles



Wires with PVC Jacket					
Poles	Mount Thread	Male		Female	
		Engineering No.	Standard Order No.	Engineering No.	Standard Order No.
4	PG9	8R4J36E03C3003	120070-0156	8R4J30E03C3003	120070-0395
	M14x1	8R4E36E03C3003	120011-0017	8R4E30E03C3003	120011-0013
5	PG9	8R5J36E03C3003	120070-0231	8R5J30E03C3003	120070-0229
	M14x1	8R5E36E03C3003	120011-0035	8R5E30E03C3003	120011-0033

Brad® Micro-Change® M12 with LED

molex®

Brad® Micro-Change® M12 Single-Ended Cordsets with LED Wiring



B30 WSOR Cable					
		Female Straight		Female 90°	
Poles	Length	Engineering No.	Standard Order No.	Engineering No.	Standard Order No.
3	1m	8030P0B30M010	120067-8454	8030P1B30M010	120067-8450
	2m	8030P0B30M020	120067-8455	8030P1B30M020	120067-8451
	3m	8030P0B30M030	120067-8456	8030P1B30M030	120067-8452
	5m	8030P0B30M050	120067-8431	8030P1B30M050	120067-8432
	10m	8030P0B30M100	120067-8457	8030P1B30M100	120067-8453
4	1m	8040P0B30M010	120067-8463	8040P1B30M010	120067-8458
	2m	8040P0B30M020	120067-8464	8040P1B30M020	120067-8459
	3m	8040P0B30M030	120067-8465	8040P1B30M030	120067-8460
	5m	8040P0B30M050	120067-8430	8040P1B30M050	120067-8461
	10m	8040P0B30M100	120067-8466	8040P1B30M100	120067-8462

Brad® Micro-Change® M12 Double-Ended Cordsets with LED Wiring



B30 WSOR Cable					
		Female to Male Straight		Female 90° to Male Straight	
Poles	Length	Engineering No.	Standard Order No.	Engineering No.	Standard Order No.
3	1m	8830P6B30M010	120067-8472	8830P7B30M010	120067-8467
	2m	8830P6B30M020	120067-8473	8830P7B30M020	120067-8468
	3m	8830P6B30M030	120067-8474	8830P7B30M030	120067-8469
	5m	8830P6B30M050	120067-8475	8830P7B30M050	120067-8470
	10m	8830P6B30M100	120067-8476	8830P7B30M100	120067-8471
4	1m	8840P6B30M010	120067-8423	8840P7B30M010	120067-8420
	2m	8840P6B30M020	120067-8424	8840P7B30M020	120067-8421
	3m	8840P6B30M030	120067-8478	8840P7B30M030	120067-8477
	5m	8840P6B30M050	120067-8425	8840P7B30M050	120067-8422
	10m	8840P6B30M100	120067-8426	8840P7B30M100	120067-8427

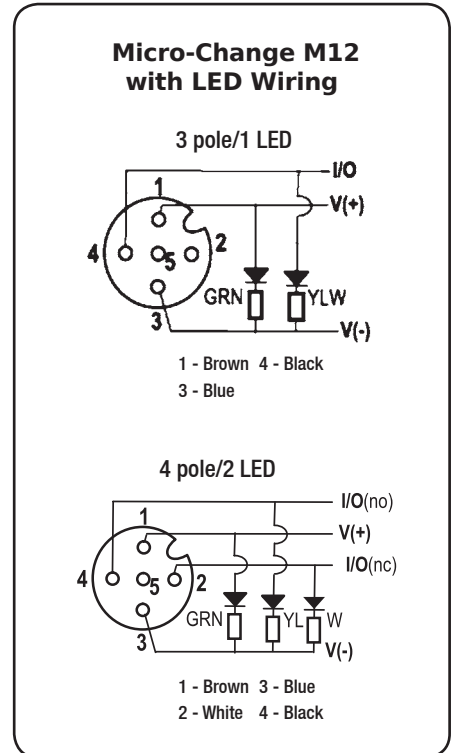

Brad® Micro-Change® M12 Shielded Cable



Brad® Micro-Change® M12 Single-Ended Shielded Cable



BS1 / BS2 WSOR Shielded Cable					
		Female Straight		Female 90°	
Poles	Length	Engineering No.	Standard Order No.	Engineering No.	Standard Order No.
4	1m	804S00BS1M010	120069-8595	804S01BS1M010	120069-8606
	2m	804S00BS1M020	120069-8596	804S01BS1M020	120069-8485
	5m	804S00BS1M050	120069-8487	804S01BS1M050	120069-8486
	10m	804S00BS1M100	120069-8556	804S01BS1M100	120069-8559
5	1m	805S00BS1M010	120069-8597	805S01BS1M010	120069-8607
	2m	805S00BS1M020	120069-8598	805S01BS1M020	120069-8608
	5m	805S00BS1M050	120069-8538	805S01BS1M050	120069-8542
	10m	805S00BS1M100	120069-8539	805S01BS1M100	120069-8543
8	1m	808S00BS2M010	120069-8599	808S01BS2M010	120069-8609
	2m	808S00BS2M020	120069-8600	808S01BS2M020	120069-8610
	5m	808S00BS2M050	120069-8601	808S01BS2M050	120069-8611
	10m	808S00BS2M100	120069-8540	808S01BS2M100	120069-8612

BS1 / BS2 Shielded WSOR Cable Specification*

BS1 Conductors: 0,34 mm² (Brown, White, Blue, Black, Grey)

BS2 Conductors: 0,25 mm² (Brown, White, Red, Blue, Pink, Grey, yellow, Green)

Jacket material: Black WSOR PUR, flame retardant, oil, UV & Weld

Slag resistant, silicone & FCKW free

Braid coverage > 80%

Diameter 4 Pole: 5,7 +/-0,2mm

Diameter 5 Pole: 6,1 +/-0,2mm

Diameter 8 Pole: 8,1 +/-0,2mm

Voltage Rating: 600V, max 4 Amps

Static Operating Temp: -40 to +90°C

Dynamic Operating Temp: -25 to +80°C

Drag Chain (>5 Mio Cycles) & torsion suitable

Approvals: UL AWM Style 21215 / CSA

Brad® Micro-Change® M12 Double-Ended Shielded Cable



BS1 / BS2 WSOR Shielded Cable					
		Female to Male Straight		Female 90° to Male Straight	
Poles	Length	Engineering No.	Standard Order No.	Engineering No.	Standard Order No.
4	1m	884S30BS1M010	120069-8649	884S31BS1M010	120069-8689
	2m	884S30BS1M020	120069-8650	884S31BS1M020	120069-8690
	5m	884S30BS1M050	120069-8652	884S31BS1M050	120069-8692
	10m	884S30BS1M100	120069-8653	884S31BS1M100	120069-8693
5	1m	885S30BS1M010	120069-8654	885S31BS1M010	120069-8694
	2m	885S30BS1M020	120069-8655	885S31BS1M020	120069-8695
	5m	885S30BS1M050	120069-8657	885S31BS1M050	120069-8697
	10m	885S30BS1M100	120069-8658	885S31BS1M100	120069-8698
8	1m	888S30BS2M010	120069-8659	888S31BS2M010	120069-8699
	2m	888S30BS2M020	120069-8660	888S31BS2M020	120069-8700
	5m	888S30BS2M050	120069-8662	888S31BS2M050	120069-8702
	10m	888S30BS2M100	120069-8663	888S31BS2M100	120069-8703

Brad® Micro-Change® M12 Sensor/Actuator Connectivity



Brad® M12 Cable Splitters

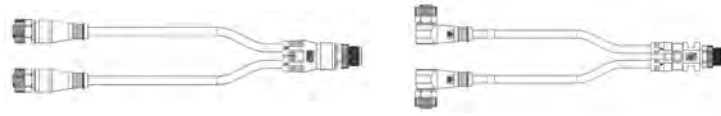

B30 WSOR Cable					
		2x Female to Male Straight		2x Female 90° to Male Straight	
Poles	Length	Engineering No.	Standard Order No.	Engineering No.	Standard Order No.
4	.6m	884A30B30M006	120068-8193	884A31B30M006	120068-8189
	1m	884A30B30M010	120068-8194	884A31B30M010	120068-8190
	2m	884A30B30M020	120068-8195	884A31B30M020	120068-8191
	5m	884A30B30M050	120068-8196	884A31B30M050	120068-8192

Brad® Micro-Change® M12 Y-Splitters & Adapters

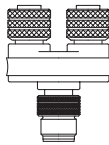

Y-Splitter M12 to M12		
1x M12 Male to 2x M12 Female		
Poles	Engineering No.	Standard Order No.
4	081204EMF00000	120068-0294
5	081205EMF00000	120068-0139

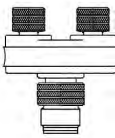

Y-Splitter M12 to M8		
1x M12 Male to 2x M8 Female		
Poles	Engineering No.	Standard Order No.
4	080804EMF00000	120089-0031

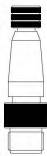

Adapter Connector		
1xM12 Male to 1xM8 Female		
Poles	Engineering No.	Standard Order No.
3	483030	120033-0002
4	484030	120033-0001

M12 Cable Splitter Wiring

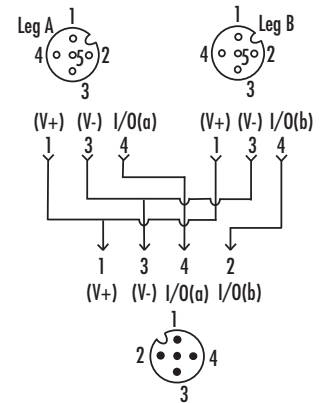

Y-Splitter Wiring Schematic

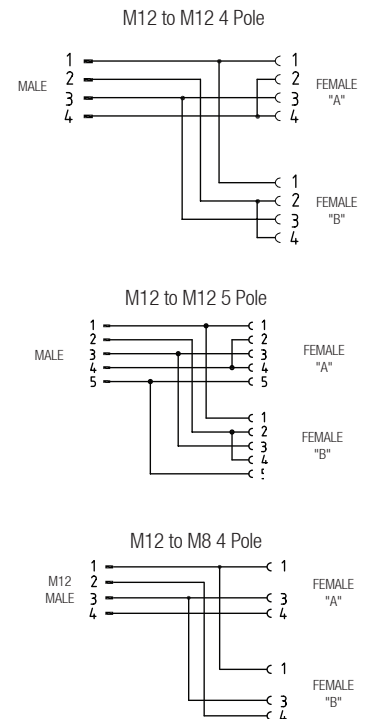

Brad® Micro-Change® M12 Sensor/Actuator Connectivity



Brad® Micro-Change® M12 Field Attachable for Sensors and Actuators

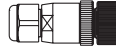
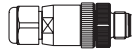

			Male Straight		Female Straight	
Poles	Cable Size	Wire Gage	Engineering No.	Standard Order No.	Engineering No.	Standard Order No.
Unshielded & Screw termination						
4	3.3-6.6	<AWG 18	8A4006-31	120071-0038	8A4000-31	120071-0035
	4.1-8.1	<AWG 18	8A4006-32	120071-0039	8A4000-32	120071-0036
5	3.3-6.6	<AWG 18	8A5006-31	120071-0045	8A5000-31	120071-0041
	4.1-8.1	<AWG 18	8A5006-32	120071-0047	8A5000-32	120071-0043
8	6.0-8.0	<AWG 20	8A8006-32	120071-0030	8A8000-32	120071-0031
Unshielded & IDC termination						
4	3.5-6.0	AWG26-22	8A4006-51	120071-0086	8A4000-51	120071-0087
	4.0-8.0	AWG22-18	8A4006-52	120071-0088	8A4000-52	120071-0089
Shielded & Screw termination						
4	6.0-8.0	<AWG 18	8A4S06-32	120071-0032	8A4S00-32	120071-0033
5	6.0-8.0	<AWG 18	8A5S06-32	120071-0034	8A5S00-32	120071-0081
8	6.0-8.0	<AWG 20	8A8S06-32	120071-0082	8A8S00-32	120071-0083



			Male 90°		Female 90°	
Poles	Cable Size	Wire Gage	Engineering No.	Standard Order No.	Engineering No.	Standard Order No.
Unshielded & Screw termination						
4	3.3-6.6	<AWG 18	8A4007-31	120071-0040	8A4001-31	120071-0037
	4.1-8.1	<AWG 18	8A4007-32	120071-5011	8A4001-32	120071-5010
5	3.3-6.6	<AWG 18	8A5007-31	120071-0049	8A5001-31	120071-0044
	4.1-8.1	<AWG 18	8A5007-32	120071-0071	8A5001-32	120071-0070

Brad® Micro-Change® M12 Bulkhead



M12 Bulkhead	
Poles	Engineering No.
5	120084-8168
8	120084-8169

Micro-Change® M12 Connector Pinout

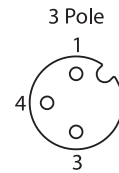

1 - Brown 4 - Black
3 - Blue

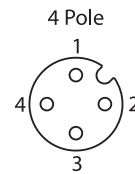

1 - Brown 3 - Blue
2 - White 4 - Black

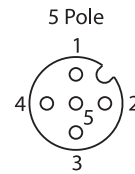

1 - Brown 4 - Black
2 - White 5 - Grey
3 - Blue

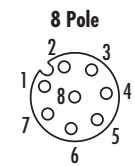

1 - White 5 - Grey
2 - Brown 6 - Pink
3 - Green 7 - Blue
4 - Yellow 8 - Red

Brad® Micro-Change® M12 Sensor/Actuator Connectivity

molex®

Flamar® Unshielded Signal & Control Cable Reels

Cross Section		Cable Code - Material	No. of Circuits	Cable Diameter in mm	Packaging		
mm ²	AWG				3x200m	1x800m	1x1500m
0.34	22	WSOR	3	4.8	155220-0052	155220-0053	155220-0054
			4	5.1	155220-0064	155220-0065	155220-0066
			5	5.5	155220-0076	155220-0077	155220-0078
		PVC	3	4.8	155210-0052	155210-0053	155210-0054
			4	5.1	155210-0064	155210-0065	155210-0066
			5	5.5	155210-0076	155210-0077	155210-0078
		PUR	3	4.8	155230-0052	155230-0053	155230-0054
			4	5.1	155230-0064	155230-0065	155230-0066
			5	5.5	155230-0076	155230-0077	155230-0078



Cross Section		Cable Code - Material	No. of Circuits	Cable Diameter in mm	3x100m	1x500m	1x1000m
mm ²	AWG				3x100m	1x500m	1x1000m
0.25	24	WSOR	8	6.4	155220-0034	155220-0035	155220-0036
		PVC			155210-0034	155210-0035	155210-0036
		PUR			155230-0034	155230-0035	155230-0036

Flamar® Shielded Signal & Control Cable Reels

Cross Section		Cable Code - Material	No. of Circuits	Cable Diameter in mm	Packaging		
mm ²	AWG				3x200m	1x800m	1x1500m
0.34	22	WSOR	3	5.4	155221-0001	155221-0002	155221-0003
			4	5.7	155221-0013*	155221-0015*	155221-0014*
			5	6.1	155221-0025*	155221-0026*	155221-0027*
		PVC	3	5.4	155211-0001	155211-0002	155211-0003
			4	5.7	155211-0013*	155211-0014*	155211-0015*
			5	6.1	155211-0025*	155211-0026*	155211-0027*
		PUR	3	5.4	155231-0001	155231-0002	155231-0003
			4	5.7	155231-0013*	155231-0014*	155231-0015*
			5	6.1	155231-0025*	155231-0026*	155231-0027*

Knurled/Hex Nut for WSOR cordsets



All WSOR M12 and M8 cordsets have a knurled/hex coupling nut to use with dynamometric torque tools to make sure that your connection is perfectly tight.



M8 Torque tool (wrench size 9)

Standard Order No.

1203035017

M12 Torque tool (wrench size 13)

Standard Order No.

1203035018

Brad® Micro-Change® M12 Closure Caps

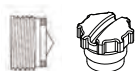

Plastic Closure Cap

To Cover Male		To Cover Female	
Engineering No.	Standard Order No.	Engineering No.	Standard Order No.
—	120308-0680	—	120358-0007



Rubber Closure Cap with Leash

To Cover Male		To Cover Female	
Engineering No.	Standard Order No.	Engineering No.	Standard Order No.
—	120076-5046	—	120076-5047

Brad® Nano-Change® M8 Sensor/Actuator Connectivity



Brad® Nano-Change® M8 connectivity provides a rugged and space-saving solution to wire a wide range of sensors and actuators from proximity switches to rotary encoders in harsh environments.



Brad® Nano-Change® M8 Single-Ended Cordsets



B41 WSOR Cable									
		Female Straight		Female 90°		Male Straight		Male 90°	
Poles	Length	Engineering No.	Standard Order No.	Engineering No.	Standard Order No.	Engineering No.	Standard Order No.	Engineering No.	Standard Order No.
3	1m	403000B41M010	120086-8655	403001B41M010	120086-8667	403006B41M010	120086-8631	403007B41M010	120086-8643
	2m	403000B41M020	120086-8656	403001B41M020	120086-8668	403006B41M020	120086-8632	403007B41M020	120086-8644
	5m	403000B41M050	120086-8657	403001B41M050	120086-8669	403006B41M050	120086-8633	403007B41M050	120086-8645
	10m	403000B41M100	120086-8658	403001B41M100	120086-8670	403006B41M100	120086-8634	403007B41M100	120086-8646
4	1m	404000B41M010	120086-8659	404001B41M010	120086-8671	404006B41M010	120086-8635	404007B41M010	120086-8647
	2m	404000B41M020	120086-8660	404001B41M020	120086-8672	404006B41M020	120086-8636	404007B41M020	120086-8648
	5m	404000B41M050	120086-8661	404001B41M050	120086-8673	404006B41M050	120086-8637	404007B41M050	120086-8649
	10m	404000B41M100	120086-8662	404001B41M100	120086-8674	404006B41M100	120086-8638	404007B41M100	120086-8650
5	1m	405000B41M010	120086-8663	405001B41M010	120086-8675	405006B41M010	120086-8639	405007B41M010	120086-8651
	2m	405000B41M020	120086-8664	405001B41M020	120086-8676	405006B41M020	120086-8640	405007B41M020	120086-8652
	5m	405000B41M050	120086-8665	405001B41M050	120086-8677	405006B41M050	120086-8641	405007B41M050	120086-8653
	10m	405000B41M100	120086-8666	405001B41M100	120086-8678	405006B41M100	120086-8642	405007B41M100	120086-8654

Build-A-Part Number Configuration Code

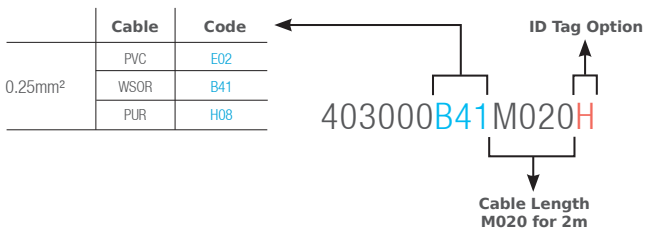

Brad® Nano-Change® M8 Sensor/Actuator Connectivity



Brad® Nano-Change® M8 Double-Ended Cordsets



B41 WSOR Cable					
Poles	Length	Female to Male Straight		Female 90° to Male Straight	
		Engineering No.	Standard Order No.	Engineering No.	Standard Order No.
3	.6m	443030B41M006	120087-8703	443031B41M006	120087-8721
	1m	443030B41M010	120087-8704	443031B41M010	120087-8722
	2m	443030B41M020	120087-8705	443031B41M020	120087-8723
	3m	443030B41M030	120087-8706	443031B41M030	120087-8724
	5m	443030B41M050	120087-8707	443031B41M050	120087-8725
4	.6m	444030B41M006	120087-8709	444031B41M006	120087-8727
	1m	444030B41M010	120087-8710	444031B41M010	120087-8728
	2m	444030B41M020	120087-8711	444031B41M020	120087-8729
	3m	444030B41M030	120087-8712	444031B41M030	120087-8730
	5m	444030B41M050	120087-8713	444031B41M050	120087-8731
5	.6m	445030B41M006	120087-8715	445031B41M006	120087-8733
	1m	445030B41M010	120087-8716	445031B41M010	120087-8734
	2m	445030B41M020	120087-8717	445031B41M020	120087-8735
	3m	445030B41M030	120087-8718	445031B41M030	120087-8736
	5m	445030B41M050	120087-8719	445031B41M050	120087-8737

B41 WSOR Cable Specification*

Conductors: 3x0,25 mm², 4x0,25 mm² 5x0,25 mm², 8x0,25 mm²

(Brown, White, Blue, Black, Grey)

(BN, WH, BE, RD, GY, GN, YE, PK)

Jacket material: Black WSOR PUR, flame retardant, oil, UV & Weld Slag resistant, silicone & FCKW free

Diameter 3 Pole: 4,5 +-0,2mm

Diameter 4 Pole: 4,8 +-0,2mm

Diameter 5 Pole: 5,3 +-0,2mm

Diameter 8 Pole: 6,4 +-0,2mm

Voltage Rating: 600V

Static Operating Temp: -40 to +90°C

Dynamic Operating Temp: -25 to +80°C

Drag Chain (>5 Mio Cycles) & torsion suitable

Approvals: UL AWM Style 21215 / CSA

Brad® Nano-Change® M8 Receptacles



Poles	Mount Thread	Male		Female	
		Engineering No.	Standard Order No.	Engineering No.	Standard Order No.
3	M8x0.5 Front	4R3F06E02C3003	120031-0004	4R3F30E02C3003	120031-0015
	M8x1 Back	4R3F46E02C200	120090-5073	4R3L40E02C200	120090-5104
4	M8x0.5 Front	4R4F06E02C3003	120031-0006	4R4F30E02C3003	120031-0049
	M8x1 Back	4R4F46E02C200	120090-5078	4R4L40E02C200	120090-8037
5	M8x0.5 Front	4R5F06E02C3003	120031-0027	4R5F46E02C200	120031-0028
	M8x1 Back	4R5F30E02C3003	120031-0028	4R5L40E02C200	120090-8056

Brad® Nano-Change® M8 Sensor/Actuator Connectivity

Brad® Nano-Change® M8 Single-Ended Cordsets w/LED

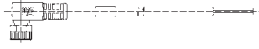

Female 90°			
Poles	Length	Engineering No.	Standard Order No.
3	1m	4030P1B41M010	120086-8687
	2m	4030P1B41M020	120086-8688
	5m	4030P1B41M050	120086-8689
	10m	4030P1B41M100	120086-8690

Brad® Nano-Change® M8 Double-Ended Cordsets w/LED

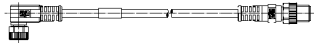

Female 90° to Male Straight			
Poles	Length	Engineering No.	Standard Order No.
3	1m	4430P7B41M006	120087-8779
	2m	4430P7B41M010	120087-8780
	5m	4430P7B41M020	120087-8781
	10m	4430P7B41M050	120087-8782

Brad® Nano-Change® M8 Y-Splitters & Adapters

Y-Splitter		
1x M8 Male to 2x M8 Female		
Poles	Engineering No.	Standard Order No.
4	080804LMF00000	120089-0033

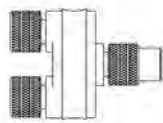

Adapter Connector		
1x M8 Male to 1x M12 Female		
Poles	Engineering No.	Standard Order No.
3	853030	120017-0004
4	854030	120017-0003

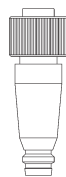

Note:
M8 male connector thread is fixed.

Nano-Change® M8 LED Connector Wiring

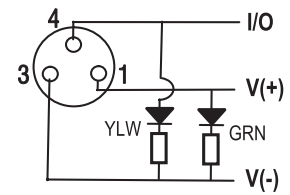

1 - Brown 4 - Black
3 - Blue

Y-Splitter Wiring Schematic

M8 to M8 4 Pole

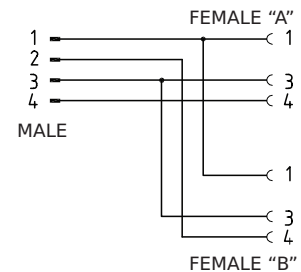

Brad® Nano-Change® M8 Sensor/Actuator Connectivity



Brad® Nano-Change® M8 Field Attachable Connectors

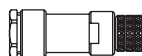
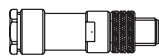

Poles	Cable Size	Wire Gage	Male Straight		Female Straight	
			Engineering No.	Standard Order No.	Engineering No.	Standard Order No.
Unshielded & soldering termination						
3	3.5-5.0	AWG 24	N03MA03124	120091-0004	N03FA03124	120091-0001
4	3.5-5.0	AWG 24	N04MA03124	120091-0010	N04FA03124	120091-0007
Unshielded & Screw termination						
3	3.5-5.0	AWG26-20	N03MA03134	120091-0023	N03FA03134	120091-0024
4	3.5-5.0	AWG26-20	N04MA03134	120091-0025	N04FA03134	120091-0026
Unshielded & IDC termination						
3	2.5-5.2	AWG24-20	N03MA03144	120091-0027	N03FA03144	120091-0028
4	2.5-5.2	AWG24-20	N04MA03144	120091-0029	N04FA03144	120091-0030

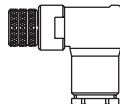
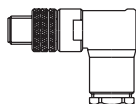

Poles	Cable Size	Wire Gage	Male 90°		Female 90°	
			Engineering No.	Standard Order No.	Engineering No.	Standard Order No.
Unshielded & soldering termination						
3	3.5-5.0	AWG 24	N03MA04124	120091-0002	N03FA04124	120091-0003
4	3.5-5.0	AWG 24	N04MA04124	120091-0012	N04FA04124	120091-0009

Nano-Change® M8 Connector Pinout

(front view)

3 Pole

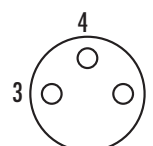

1 - Brown 4 - Black
3 - Blue

4 Pole

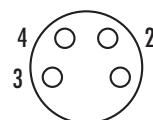

1 - Brown 3 - Blue
2 - White 4 - Black

5 Pole

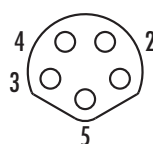

1 - Brown 4 - Black
2 - White 5 - Grey
3 - Blue

Brad® Nano-Change® M8 Sensor/Actuator Connectivity

molex®

Flamar® Unshielded Signal & Control Cable Reels



Cross Section		Cable Code - Material	No. of Circuits	Cable Diameter in mm	Packaging		
mm ²	AWG				3x200m	1x800m	1x1500m
0.25	24	WSOR	3	4.5	155220-0001	155220-0002	155220-0003
			4	4.8	155220-0013	155220-0014	155220-0015
			5	5.3	155220-0025	155220-0026	155220-0027
		PVC	3	4.5	155210-0001	155210-0002	155210-0003
			4	4.8	155210-0013	155210-0014	155210-0015
			5	5.3	155210-0025	155210-0026	155210-0027
		PUR	3	4.5	155230-0001	155230-0002	155230-0003
			4	4.8	155230-0013	155230-0014	155230-0015
			5	5.3	155230-0025	155230-0026	155230-0027

Brad® Nano-Change® M8 Closure Caps

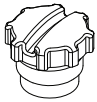

Plastic Closure Cap

To Cover Female	
Engineering No.	Standard Order No.
—	120308-0677

Brad® mPm® DIN Valve Connectors



The mPm® DIN valve connectors conform to the industry standard of electrical connectors EN 175301-803, which are commonly used with solenoid valves. The new generation of Molex® DIN connectors provides unsurpassed sealing performance, easier assembly and mounting and lower applied costs.



Brad® mPm® Field Attachable DIN Valve Connectors

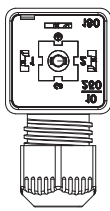

Form A External Thread		
Description	Engineering No.	Standard Order No.
Non-Electronic	C28200N2RSN	121201-0034
With Electronic	S28200TC422RSN	121207-0358



Form B External Thread		
Description	Engineering No.	Standard Order No.
Non-Electronic	C22200N2RSN	121202-0012
With Electronic	S22200TC422RSN	121208-0230

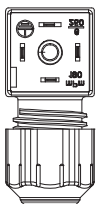

Form C External Thread		
Description	Engineering No.	Standard Order No.
Non-Electronic	C92200N2TSN	121203-0009
With Electronic	S92200TC422TSN	121209-0197



Form Micro External Thread		
Description	Engineering No.	Standard Order No.
Non-Electronic	C25200N2TSN	121204-0010
With Electronic	S25200TC422TSN	121210-0332

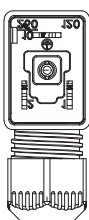

Form Industrial External Thread		
Description	Engineering No.	Standard Order No.
Non-Electronic	C29200N2TSN	121205-0012
With Electronic	S29200TC422TSN	121211-0332

Circuit C4 Schematics

Bipolar yellow LED and VDR to protect supply and switch.

Available voltage rating on C4 circuit:

12, 24, 48, 115 and 230 V AC-DC

12, 24 and 115V AC-DC

(for type 192 only)

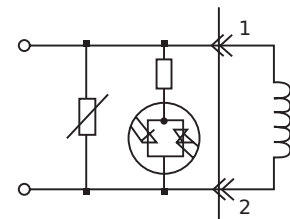

Note:

The mPm® DIN valve connectors are available in various version, Pole count, housing and electronics. For further information consult our website or automation catalog or your local sales support.

Further technical information, datasheet or drawing can be downloaded from the Molex® website using the ordering part number.

Brad® mPm® DIN Valve Connectors



The mPm® connectors with molded-in cable are suitable for use with most types of solenoid. They offer a fast and efficient method of connection resulting in greatly reduced installation time and costs.



Brad® mPm® DIN Valve Connectors Over Molded to M12 Male Connector

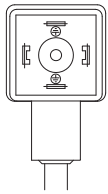

DIN Valve Connector, FORM A, C4 Circuit, Ground Pos H6/H12				
Length	Male Straight		Male 90°	
	Engineering No.	Standard Order No.	Engineering No.	Standard Order No.
.6m	E850B0P12M006	121036-0192	E850B2P12M006	121036-0208
1m	E850B0P12M010	121036-0193	E850B2P12M010	121036-0209
1.5m	E850B0P12M015	121036-0194	E850B2P12M015	121036-0821
3m	E850B0P12M030	121036-0356	E850B2P12M030	121036-0211



DIN Valve Connector, FORM Industrial, C4 Circuit, Ground Pos H6				
.6m	F850B0P12M006	121036-0352	F850B2P12M006	121036-0505
1m	F850B0P12M010	121036-0255	F850B2P12M010	121036-0506
1.5m	F850B0P12M015	121036-0822	F850B2P12M015	121036-0823
3m	F850B0P12M030	121036-0257	F850B2P12M030	121036-0824



DIN Valve Connector, FORM B, C4 Circuit, Ground Pos H6				
.6m	D850B0P12M006	121036-0056	D850B2P12M006	121036-0828
1m	D850B0P12M010	121036-0825	D850B2P12M010	121036-0829
1.5m	D850B0P12M015	121036-0826	D850B2P12M015	121036-0830
3m	D850B0P12M030	121036-0827	D850B2P12M030	121036-0831



DIN Valve Connector, FORM C, C4 Circuit, Ground Pos H6/H12				
.6m	H850B0P12M006	121036-0295	H850B2P12M006	121036-0832
1m	H850B0P12M010	121036-0296	H850B2P12M010	121036-0305
1.5m	H850B0P12M015	121036-0471	H850B2P12M015	121036-0833
3m	H850B0P12M030	121036-0440	H850B2P12M030	121036-0834



DIN Valve Connector, FORM Micro, C4 Circuit, Ground Pos H6/H12				
.6m	G850B0P12M006	121036-0406	G850B2P12M006	121036-0836
1m	G850B0P12M010	121036-0277	G850B2P12M010	121036-0621
1.5m	G850B0P12M015	121036-0835	G850B2P12M015	121036-0837
3m	G850B0P12M030	121036-0481	G850B2P12M030	121035-0270

DIN PUR/PVC Cable Specification

Conductors: 3x0,5mm² PVC

(Brown, Blue, Green/Yellow)

Jacket Material: Black PUR

Voltage Rating: 300V

Operating Temperature:

-5 to +90°C (flexing)

-30 to +90°C (static)

Diameter: 5,5 ± 0,3 mm

Note:

The mPm® DIN valve over molded cordsets are available in various versions, Pole count, housing, cable, lengths and electronics. For further information consult our website or automation catalog or your local sales support.

Further technical information, datasheet or drawing can be downloaded from the Molex® website using the ordering part number.

Get more insights at: molex.com/industry/industrial.html

molex[®]
one company › a world of innovation