

A

B

C

D

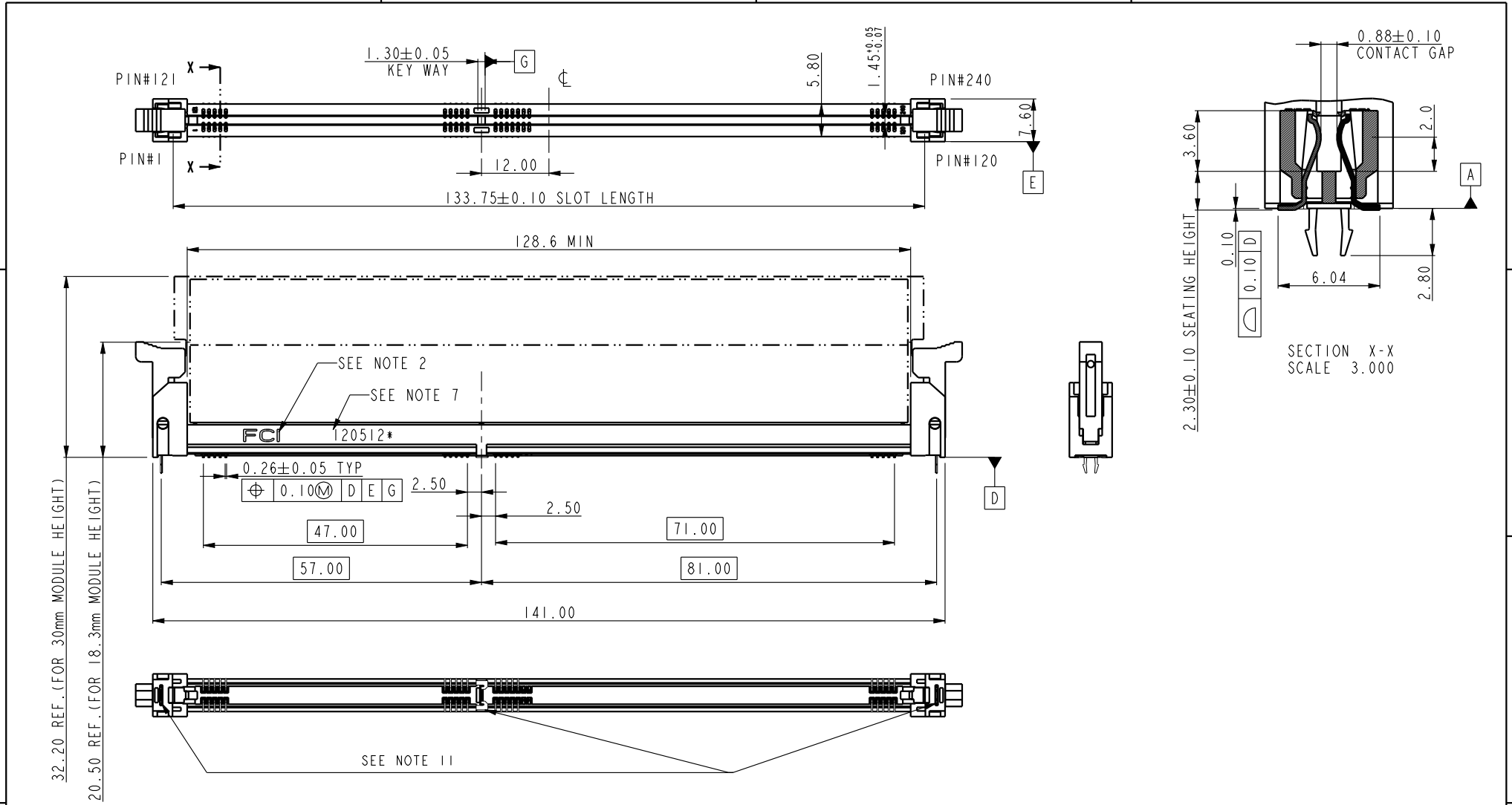

| | | | | | | | | | | |
|---------------|---------------------------------------|-------|------------|--|---|------------------------|--------------------|----------------|----------|-------|
| spec ref | * | dr | Rick Bian | 2010/07/04 | projection | MM | size | A4 | scale | 1.000 |
| tolerance std | TOLERANCES UNLESS OTHERWISE SPECIFIED | eng | Jeny Ren | 2017/12/28 | | | ecn no | ELX-DG-28885-1 | | |
| surface | | chr | - | - | | | product family | rel level | Released | |
| | | appr | Nickor Zuo | 2018/02/09 | | | | | | |
| | linear | 0.X | ±0.5 | Amphenol FCi www.fci.com | title DDR III SMT SOCKET ASS'Y (WITH LCP HOUSING) | | dwg no 10104389 | rev F | | |
| | | 0.XX | ±0.30 | | | | | | | |
| | | 0.XXX | ±0.15 | | | | | | | |
| | angular | 0° | ±2° | cat. no. | * | Product - Customer Drw | | sheet 1 of 4 | | |

A

B

C

D

A

B

C

D

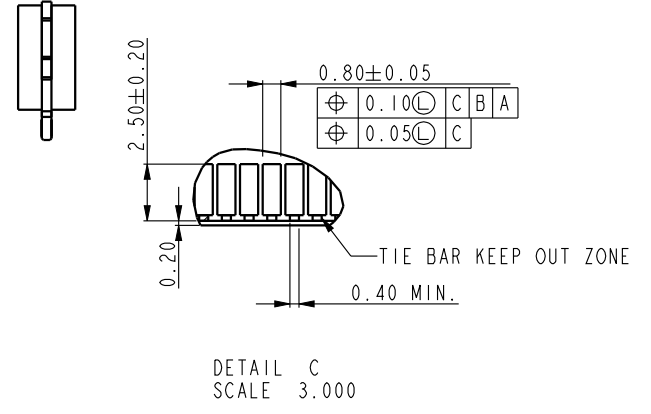
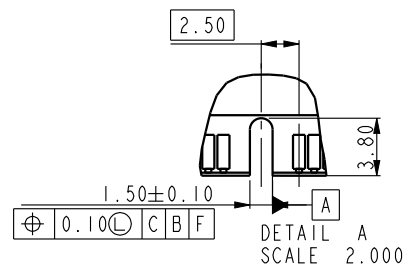
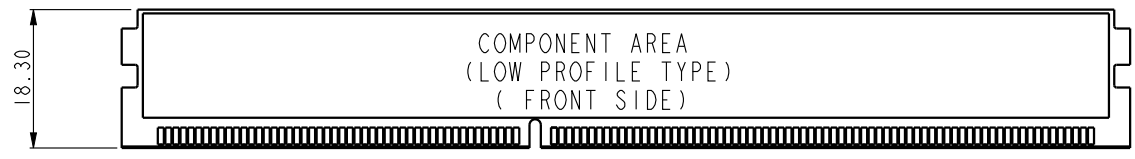
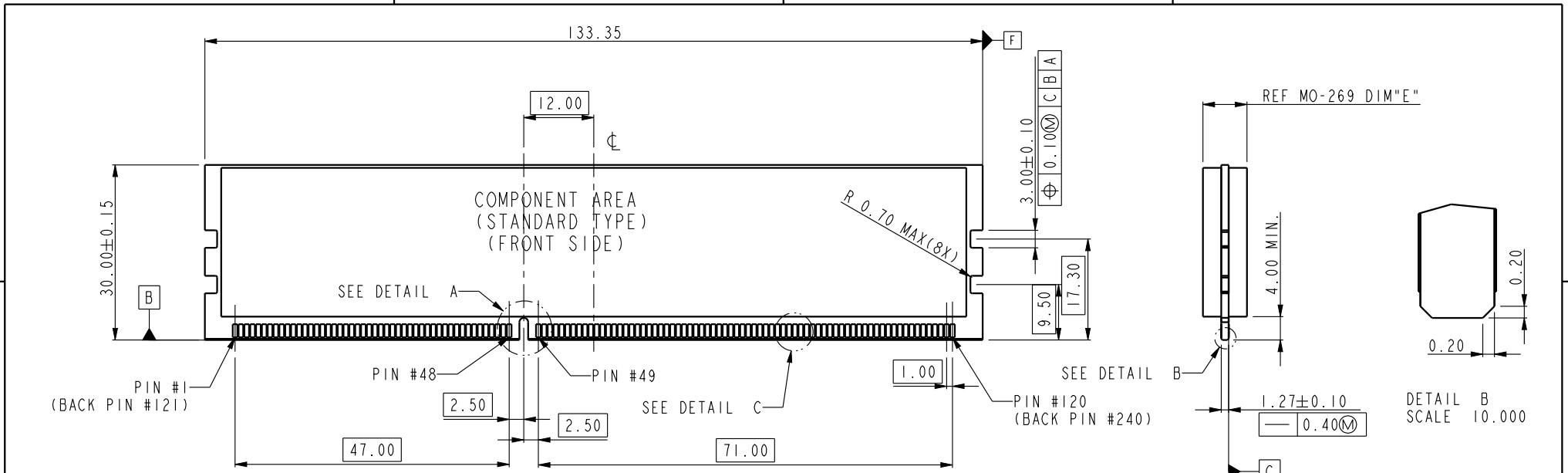

| | | | | | | | | |
|---------------------|------------|------------|----------------|--------------------------|------------------------|----------------|-------|-------|
| dr | Rick Bian | 2010/07/04 | projection | MM | size | A4 | scale | 1.000 |
| eng | Jeny Ren | 2017/12/28 | | | ecn no | ELX-DG-28885-1 | | |
| chr | - | - | | | rel level | Released | | |
| appr | Nickor Zuo | 2018/02/09 | product family | | | | | |
| Amphenol FCI | title | | | DDR III SMT SOCKET ASS'Y | dwg no | 10104389 | | rev |
| www.fci.com | cat. no. | | | * | Product - Customer Drw | sheet 2 of 4 | | F |



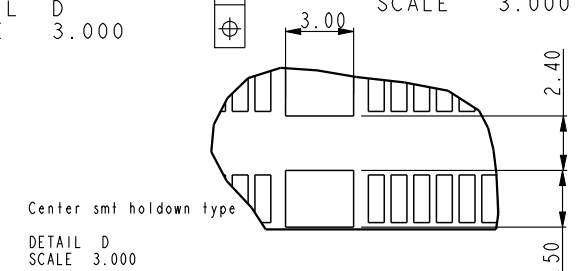
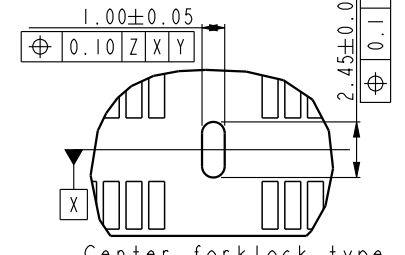
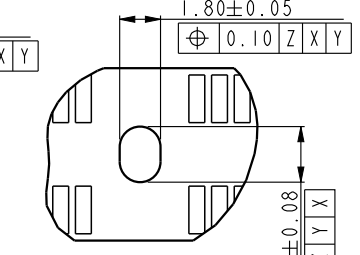
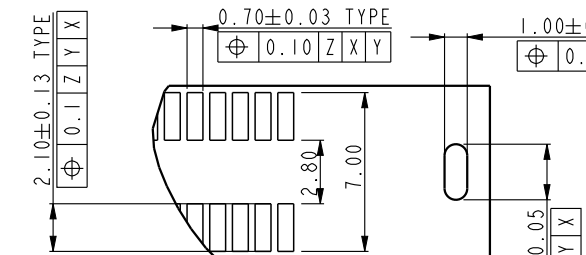
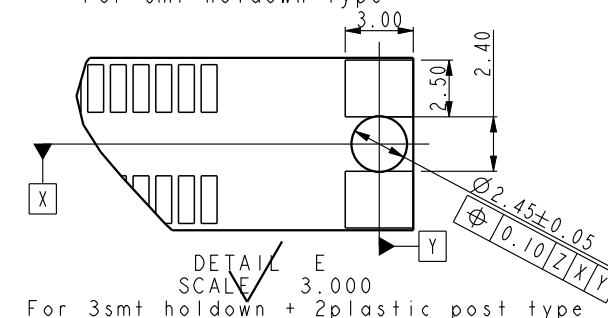
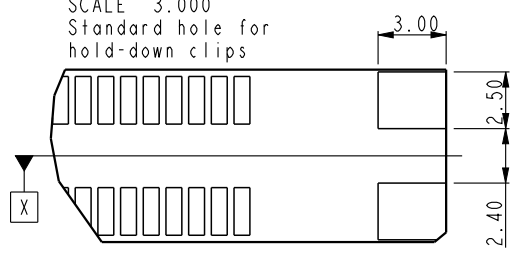
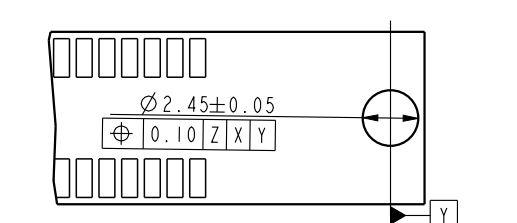
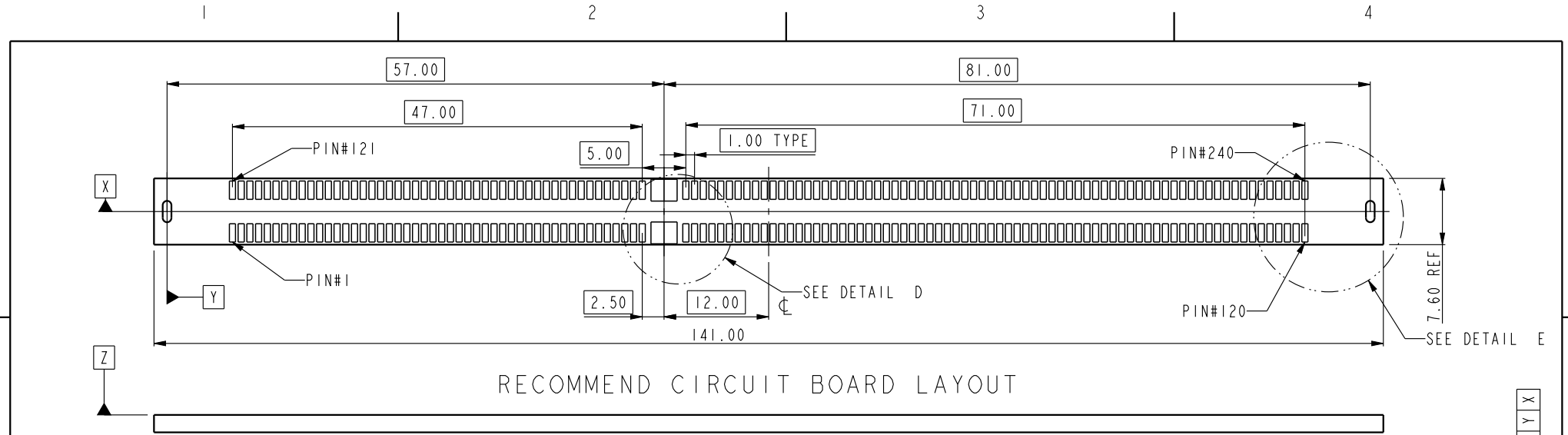

| | | | | | | | | | |
|--------------|------------|------------|----------------|----------|--|----------------|--------------|-------|----------|
| dr | Rick Bian | 2010/07/04 | projection | MM ←→ | size | A4 | scale | 1.000 | |
| eng | Jeny Ren | 2017/12/28 | | | ecn no | ELX-DG-28885-1 | | | |
| chr | - | - | | | rel level | Released | | | |
| appr | Nickor Zuo | 2018/02/09 | product family | | rev | F | | | |
| Amphenol FCI | | | title | | DDR III SMT SOCKET ASS'Y (WITH LCP HOUSING) | | dwg no | | 10104389 |
| www.fci.com | | | cat. no. | | Product - Customer Drw | | sheet 3 of 4 | | |

A

B

C

D

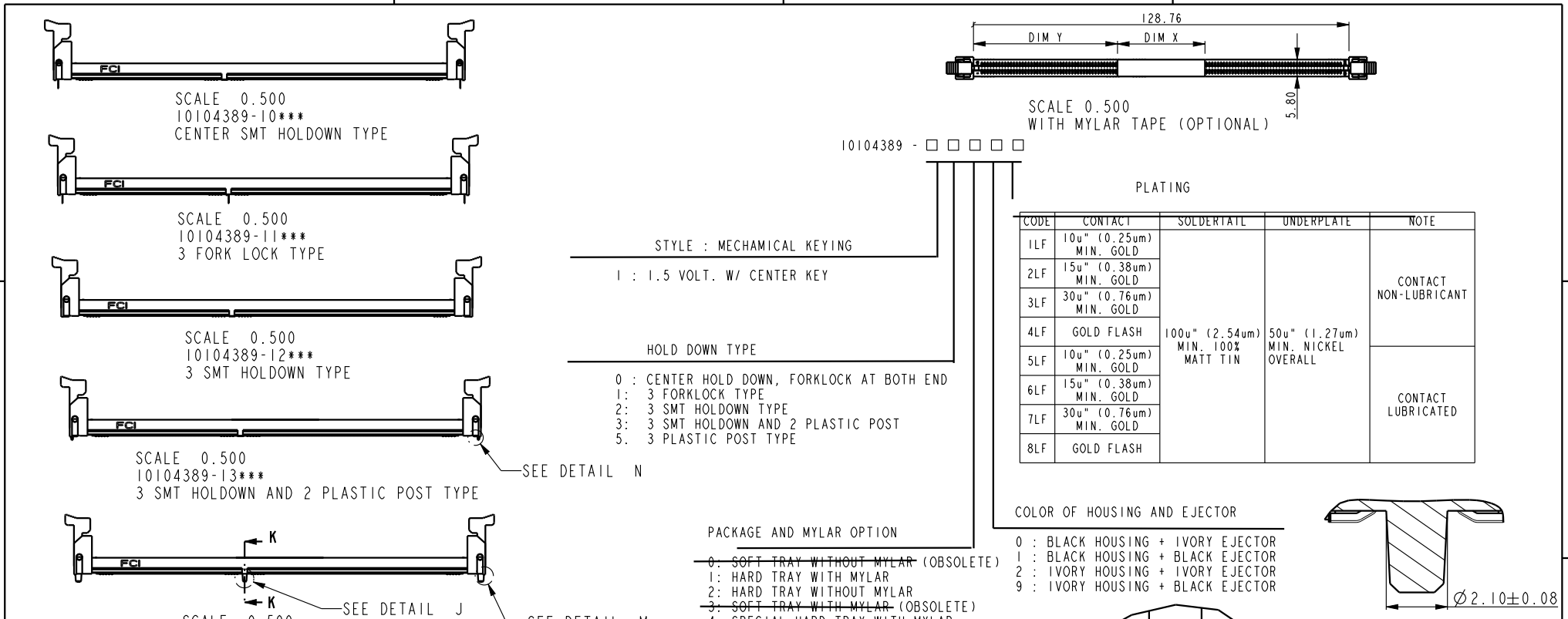

- NOTES:
- MATERIAL:
HOUSING: HIGH PERFORMANCE RESINS, GLASS FILLED UL94V-0 RATED.
EJECTOR: HIGH PERFORMANCE RESINS, GLASS FILLED UL94V-0 RATED.
TERMINAL: HIGH PERFORMANCE COPPER ALLOY
METAL CLIP: COPPER ALLOY.
 - FCI LOGO TO BE APPROXIMATELY LOCATED AS SHOWN ON PRINT.
 - PRODUCT SPECIFICATION: GS-12-486.
 - PACKAGING SPECIFICATION: GS-14-899.
 - RECOMMENDED STENCIL THICKNESS NO LESS THAN 0.15 mm.
 - FOR OPTIMUM PERFORMANCE. THE TIE BAR IS TO BE ON AN INTERNAL LAYER SO THAT THE REMNANT CANNOT CAUSE CONTACT DAMAGE.
 - THE DATE CODE IS SHOWN "MMDDYY*.". "*" MEANS PRODUCTION LINE.
 - THIS PRODUCT MEETS EUROPEAN UNION DIRECTIVES AND OTHER COUNTRY REGULATIONS AS DESCRIBED IN GS-22-008.
 - THE HOUSING WILL WITH STAND EXPOSURE TO 260°C PEAK TEMPERATURE FOR 10 SECONDS IN AN IR REFLOW SOLDERING APPLICATION.
 - PRODUCT APPLICATION SPEC GS-20-089.
 - THE HOLDOWN TYPES ARE OPTION FOR HOLDOWN OR FORKLOCK.

- PACKAGE AND MYLAR OPTION
- 0: SOFT TRAY WITHOUT MYLAR (OBSOLETE)
1: HARD TRAY WITH MYLAR
2: HARD TRAY WITHOUT MYLAR
3: SOFT TRAY WITH MYLAR (OBSOLETE)
4: SPECIAL HARD TRAY WITH MYLAR
5: SPECIAL HARD TRAY WITHOUT MYLAR
6: SPECIAL HARD TRAY WITH MYLAR(24PCS/TRAY)

| | | | | | | | | |
|--------------|------------|--|----------------|----|-----------------------|----|-------|-------|
| dr | Rick Bian | 2010/07/04 | projection | MM | size | A4 | scale | 1.000 |
| eng | Jeny Ren | 2017/12/28 | | | ecn no ELX-DG-28885-1 | | | |
| chr | - | - | | | rel level Released | | | |
| appr | Nickor Zuo | 2018/02/09 | product family | | rev F | | | |
| Amphenol FCI | | title | | | dwg no | | rev | |
| www.fci.com | | DDR III SMT SOCKET ASS'Y (WITH LCP HOUSING) | | | 10104389 | | F | |
| cat. no. | | Product - Customer Drw | | | sheet 4 of 4 | | | |