

User Manual

PCE-5126

LGA1155

Intel[®] Core[™] i7/i5/i3/Pentium[®] /
Xeon[®] PICMG 1.3 Single Host
Board with (ECC) DDR3 / Dual
GbE LAN

ADVANTECH

Enabling an Intelligent Planet

Copyright

The documentation and the software included with this product are copyrighted 2011 by Advantech Co., Ltd. All rights are reserved. Advantech Co., Ltd. reserves the right to make improvements in the products described in this manual at any time without notice. No part of this manual may be reproduced, copied, translated or transmitted in any form or by any means without the prior written permission of Advantech Co., Ltd. Information provided in this manual is intended to be accurate and reliable. However, Advantech Co., Ltd. assumes no responsibility for its use, nor for any infringements of the rights of third parties, which may result from its use.

Acknowledgements

AMIBIOS is a trademark of American Megatrends Inc.

Intel[®], Core™i7/i5/i3, Pentium[®] Xeon[®] are trademarks of Intel[®] Corporation.

WinBond is a trademark of Winbond Corporation.

All other product names or trademarks are the properties of their respective owners.

Product Warranty (2 years)

Advantech warrants to you, the original purchaser, that each of its products will be free from defects in materials and workmanship for two years from the date of purchase.

This warranty does not apply to any products which have been repaired or altered by persons other than repair personnel authorized by Advantech, or which have been subject to misuse, abuse, accident or improper installation. Advantech assumes no liability under the terms of this warranty as a consequence of such events.

Because of Advantech's high quality-control standards and rigorous testing, most of our customers never need to use our repair service. If an Advantech product is defective, it will be repaired or replaced at no charge during the warranty period. For out-of-warranty repairs, you will be billed according to the cost of replacement materials, service time and freight. Please consult your dealer for more details.

If you think you have a defective product, follow these steps:

1. Collect all the information about the problem encountered. (For example, CPU speed, Advantech products used, other hardware and software used, etc.) Note anything abnormal and list any onscreen messages you get when the problem occurs.
2. Call your dealer and describe the problem. Please have your manual, product, and any helpful information readily available.
3. If your product is diagnosed as defective, obtain an RMA (return merchandise authorization) number from your dealer. This allows us to process your return more quickly.
4. Carefully pack the defective product, a fully-completed Repair and Replacement Order Card and a photocopy proof of purchase date (such as your sales receipt) in a shippable container. A product returned without proof of the purchase date is not eligible for warranty service.
5. Write the RMA number visibly on the outside of the package and ship it prepaid to your dealer.

Declaration of Conformity

FCC Class A

Note: This equipment has been tested and found to comply with the limits for a Class A digital device, pursuant to part 15 of the FCC Rules. These limits are designed to provide reasonable protection against harmful interference when the equipment is operated in a commercial environment. This equipment generates, uses, and can radiate radio frequency energy and, if not installed and used in accordance with the instruction manual, may cause harmful interference to radio communications. Operation of this equipment in a residential area is likely to cause harmful interference in which case the user will be required to correct the interference at his own expense.

Caution! *There is a danger of a new battery exploding if it is incorrectly installed. Do not attempt to recharge, force open, or heat the battery. Replace the battery only with the same or equivalent type recommended by the manufacturer. Discard used batteries according to the manufacturer's instructions.*



A Message to the Customer

Advantech Customer Services

Each and every Advantech product is built to the most exacting specifications to ensure reliable performance in the harsh and demanding conditions typical of industrial environments. Whether your new Advantech equipment is destined for the laboratory or the factory floor, you can be assured that your product will provide the reliability and ease of operation for which the name Advantech has come to be known.

Your satisfaction is our primary concern. Here is a guide to Advantech's customer services. To ensure you get the full benefit of our services, please follow the instructions below carefully.

Technical Support

We want you to get the maximum performance from your products. So if you run into technical difficulties, we are here to help. For the most frequently asked questions, you can easily find answers in your product documentation. These answers are normally a lot more detailed than the ones we can give over the phone.

So please consult this manual first. If you still cannot find the answer, gather all the information or questions that apply to your problem, and with the product close at hand, call your dealer. Our dealers are well trained and ready to give you the support you need to get the most from your Advantech products. In fact, most problems reported are minor and are able to be easily solved over the phone.

In addition, free technical support is available from Advantech engineers every business day. We are always ready to give advice on application requirements or specific information on the installation and operation of any of our products.

Memory Compatibility

PCE-5126 Memory Tested for Compatibility

Brand	Size	Speed	ECC	Vendor PN	Advantech PN	Memory
Transcend	1GB	DDR3 1066	N	TS128MLK64V1U / TS2KNU28100-1S	96D3-1G1066NN-TR	SEC K4B1G0846D-HCF8 (128x8)
	1GB	DDR3 1066	N	TS128MLK64V1U	96D3-1G1066NN-TR	SEC K4B1G0846D HCH9 ENJ038A3 (128x8)
	2GB	DDR3 1066	N	TS256MLK64V1U / TS5KNU28300-1S	96D3-2G1066NN-TR	SEC K4B1G0846D-HCF9(128x8)
	1GB	DDR3 1333	N	TS128MLK64V3U	96D3-1G-1333NN-TR	ELPIDA J1108BDBG-DJ-F(128x8)
	1GB	DDR3 1333	N	TS128MLK64V3U		Micron 9GF22 D9KPT (128x8)
	2GB	DDR3 1333	N	TS256MLK64V3U		SEC 907 HCH9 K4B1G08460(128x8)
Apacer	1GB	DDR3 1066	N	78.01GC3.420	96D3-1G1066NN-AP	ELPIDA J1108BDSE-DJ-F (128x8)
	2GB	DDR3 1066	N	78.A1GC3.421	96D3-2G1066NN-AP	ELPIDA J1108BDSE-DJ-F (128x8)
	4GB	DDR3 1066	N	78.B1GDJ.AF1	96D3-1G1066NN-AP	Hynix H5TQ2G83AFR H9C (256x8)
	1GB	DDR3 1333	N	78.A1GC6.421	96D3-1G1333NN-AP	ELPIDA J1108BDBG-DJ-F (128x8)
	2GB	DDR3 1333	N	78.A1GC6.421	96D3-2G1333NN-AP	ELPIDA J1108BDBG-DJ-F (128x8)
	2GB	DDR3 1333	N	78.A1GDE.AF00C	96D3-2G1333NN-AP1	Hynix H5TQ2G838FR(256x8)
	4GB	DDR3 1333	N	78.B1GDE.AF1		Hynix H5TQ2G83AFR H9C(256x8)
	2GB	DDR3 1066	Y	78.A1GC5.423		ELPIDA J1108BDBG-DJ-F (128x8)
	4GB	DDR3 1066	Y	78.B1GDK.AF3		Hynix H5TQ2G83AFR H9C (256x8)
	1GB	DDR3 1333	Y	78.01GC8.422	96D3-1G1333E-AP	ELPIDA J1108BDBG-DJ-F (128x8)
	2GB	DDR3 1333	Y	78.A1GC8.423	96D3-2G1333E-AP	ELPIDA J1108BDBG-DJ-F (128x8)
	4GB	DDR3 1333	Y	78.B1GDF.AF3		Hynix H5TQ2G83AFR H9C (256x8)
Kingston	1GB	DDR3 1333	N	KVR1333D3N9/1G		HYNIX H5TQ1G83BFR H9C 928AK (128x8)
	2GB	DDR3 1333	N	TS128MLK64V3U		ELPIDA J1108BDBG-DJ-F 093309DLK20 (256x8)
ATP	2GB	DDR3 1333	N	AQ56M72E8BJH9S		SEC 952 HCH9 K4B1G0846E (128x8)(128x8)
	4GB	DDR3 1333	N	AQ12M72E8BKH9S	96D3-4G1333E-AT	SAMSUNG 928 K4B2G0846B-HCH9 (256x8)

Specification Comparison

Model Name	Memory	LAN	VGA	USB	COM	Remote Management
PCE-5126QVG-00A1E	Non-ECC	1 GbE	Yes	10	2	SNMP-1000
PCE-5126QG2-00A1E	Non-ECC	2 GbE	Yes	13	2	SNMP-1000
PCE-5126WG2-00A1E	ECC/Non-ECC	2 GbE	Yes	13	2	SNMP-1000

Processor Support

Processor	PCE-5126QVG-00A1E	PCE-5126QG2-00A1E	PCE-5126WG2-00A1E
Core i7-2600	Yes	Yes	-
Core i5-2400	Yes	Yes	-
Core i3-2120	Yes	Yes	Yes
Pentium G850	Yes	Yes	Yes
XEONE3-1275	-	-	Yes
XEONE3-1225	-	-	Yes

Backplane Support Matrix Table

Model processor	Backplane	
	PCE-5XXX	PCE-7XXX
PCE-5126QVG-00A1E	Yes	-
PCE-5126QG2-00A1E	Yes	-
PCE-5126WG2-00A1E	Yes	Yes (Except PCE-7B10-04A1E)

Note!  If PCE-5126 is used on different backplanes which has different PCIe configuration. Below message would be showed on first time power on, and user has to turn off AC power and then turn on for PCIe re-configuration.

Caution!  PCIe configuration error! Please turn off AC power before re-configuration.

Initial Inspection

Before you begin installing your motherboard, please make sure that the following materials have been shipped:

- 1 PCE-5126 PICMG 1.3 Single Host Board
- 1 PCE-5126 startup manual
- 1 CD with utility
- 1 User note for full-sized CPU card P/N: 2002721020
- 2 Serial ATA HDD data cable P/N: 1700003194
- 2 Serial ATA HDD power cable P/N: 1703150102
- 1 COM + printer ports cable kit P/N: 1701260305
- 1 4-port USB cable kit P/N: 1700008461
- Keyboard and mouse Y cable P/N: 1700060202
- 1 jumper package P/N: 9689000068
- 1 warranty card

If any of these items are missing or damaged, contact your distributor or sales representative immediately. We have carefully inspected the PCE-5126 mechanically and electrically before shipment. It should be free of marks and scratches and in perfect working order upon receipt. As you unpack the PCE-5126, check it for signs of shipping damage. (For example, damaged box, scratches, dents, etc.) If it is damaged or it fails to meet the specifications, notify our service department or your local sales representative immediately. Also notify the carrier. Retain the shipping carton and packing material for inspection by the carrier. After inspection, we will make arrangements to repair or replace the unit.

Contents

Chapter 1	Hardware Configuration	1
1.1	Introduction	2
1.2	Features & Benefits	2
1.3	Specifications	3
1.3.1	System	3
1.3.2	Memory	3
1.3.3	Input/Output	4
1.3.4	Graphics	4
1.3.5	Ethernet LAN	4
1.3.6	Industrial features	4
1.3.7	Mechanical and environmental specifications	4
1.4	Jumpers and Connectors	5
	Table 1.1: Jumper list	5
	Table 1.2: Connector list	5
1.5	Board Layout: Jumper and Connector Locations	6
	Figure 1.1 Jumper and connector locations	6
1.6	PCE-5126 Block Diagram	7
	Figure 1.2 PCE-5126 block diagram	7
1.7	Safety Precautions	8
1.8	Jumper Settings	8
1.8.1	How to set jumpers	8
1.8.2	BIOS CMOS/ME data clear (JCMOS1/JMECLR1)	9
	Table 1.3: Clear BIOS CMOS/ME Data (JCMOS1/JMECLR1)	9
1.8.3	Watchdog timer output (JWDT1)	10
	Table 1.4: Watchdog timer output (JWDT1)	10
	Table 1.5: H/W monitor alarm (JOBS1)	10
1.9	System Memory	10
1.10	Memory Installation Procedures	11
1.11	Cache Memory	11
1.12	Processor Installation	11
1.13	Processor Cooler Installation	13
Chapter 2	Connecting Peripherals	15
2.1	Introduction	16
2.2	Parallel Port (LPT1)	16
2.3	USB Ports (USB12, USB34, USB56, USB78)	16
2.4	VGA Connectors (VGA1)	17
2.5	Serial Ports (COM1 & COM2)	17
2.6	PS/2 Keyboard and Mouse Connector (KBMS1/KBMS2)	18
2.7	CPU Fan Connector (CPUFAN1)	18
2.8	Front Panel Connectors (JFP1, JFP2 & JFP3)	19
2.8.1	Power LED and keyboard lock (JFP3)	19
	Table 2.1: PS/2 or ATX power supply LED status	19
2.8.2	External speaker (JFP2)	20
2.8.3	Reset connector (JFP1)	20
2.8.4	HDD LED connector (JFP2)	20
2.8.5	ATX soft power switch (JFP1)	20
2.9	H/W Monitor/Watchdog Timer/Infrared	21
2.9.1	H/W Monitor Alarm (JOBS1)	21
2.9.2	Watchdog Timer (JWDT1)	21
2.9.3	Infrared Interface (JIR1)	21
2.10	LAN Ports (LAN1 & LAN2)	22
	Table 2.2: LAN LED Indicators	22

2.11	High Definition Audio Module Interface (HDAUD1)	23
	Figure 2.1 Jumper and connector locations of PCA-AUDIO-HDA1E	24
2.12	GPIO Header (GPIO1).....	25
2.13	Case Open Connector (JCASE1)	25
2.14	Front Panel LAN Indicator Connector (LANLED1).....	26
	Table 2.3: LAN LED Indicators	26
2.15	Serial ATA Interface (SATA1~SATA6).....	27
2.16	LPC Extension Interface (LPC1).....	27

Chapter 3 AMI BIOS Setup..... 29

3.1	Introduction	30
	Figure 3.1 Setup program initial screen.....	30
3.2	Entering Setup	31
3.2.1	Main Setup.....	31
	Figure 3.2 Main setup screen	31
3.2.2	Advanced BIOS Features Setup.....	32
	Figure 3.3 Advanced BIOS features setup screen	32
	Figure 3.4 Advantech BIOS Update V1.2.....	33
	Figure 3.5 ACPI Settings	33
	Figure 3.6 TPM Configuration	34
	Figure 3.7 CPU Configuration	35
	Figure 3.8 Socket 0 CPU Information.....	35
	Figure 3.9 SATA Configuration.....	36
	Figure 3.10 Intel IGD SWSCI OpRegion Configuration	37
	Figure 3.11 Intel Trusted Execution Technology Configuration...	38
	Figure 3.12 USB Configuration.....	38
	Figure 3.13 AMT Configuration	39
	Figure 3.14 Super IO Configuration.....	40
	Figure 3.15 Serial Port 1 Configuration	40
	Figure 3.16 Serial Port 2 Configuration	41
	Figure 3.17 Parallel Configuration	41
	Figure 3.18 PC Health Status	42
3.2.3	Chipset.....	43
	Figure 3.19 Chipset	43
	Figure 3.20 North Bridge	43
	Figure 3.21 South Bridge.....	44
	Figure 3.22 USB Configuration.....	45
	Figure 3.23 ME Subsystem	46
	Figure 3.24 Chipset Reference Board	47
3.2.4	Boot	47
	Figure 3.25 Boot	47
3.2.5	Security.....	48
	Figure 3.26 Security	48
3.2.6	Save & Exit	49
	Figure 3.27 Save & Exit.....	49

Chapter 4 Value-Added Software Services 51

4.1	Value-Added Software Services	52
4.1.1	Software API.....	52
4.1.2	Software Utility.....	53

Chapter 5 Chipset Software Installation Utility 55

5.1	Before You Begin.....	56
5.2	Introduction	56

5.3	Windows® XP / Windows® 7 Driver Setup	57
Chapter 6	Integrated Graphic Device Setup	59
6.1	Introduction	60
6.2	Windows XP/Windows 7 Driver Setup	60
Chapter 7	LAN Configuration.....	61
7.1	Introduction	62
7.2	Installation	62
7.3	Win XP /Win 7 Driver Setup (LAN).....	62
Chapter 8	SATA RAID Setup	63
8.1	Introduction	64
8.2	SATA RAID Driver and Utility Setup	64
Appendix A	Programming the Watchdog Timer..	65
A.1	Introduction	66
A.1.1	Watchdog timer overview.....	66
A.1.2	Programming the watchdog timer	66
	Table A.1: Watchdog timer registers.....	67
A.1.3	Example program.....	68
Appendix B	I/O Pin Assignments.....	73
B.1	Parallel Port Connector (LPT1).....	74
	Table B.1: Parallel port connector (LPT1).....	74
B.2	VGA Connector (VGA1).....	74
	Table B.2: VGA connector (VGA1).....	74
B.3	RS 232 Serial Port (COM2).....	75
	Table B.3: RS-232 serial port (COM2).....	75
B.4	USB Header (USB12 ~ 78).....	75
	Table B.4: USB Header (USB12 ~ 78).....	75
B.5	PS/2 Keyboard/Mouse Connector (KBMS1).....	76
	Table B.5: PS/2 keyboard/mouse connector (KBMS1).....	76
B.6	External Keyboard Connector (KBMS2).....	76
	Table B.6: External keyboard connector (KBMS2).....	76
B.7	CPU Fan Power Connector (CPUFAN1).....	76
	Table B.7: CPU fan power connector (CPUFAN1).....	76
B.8	Power LED and Keyboard Lock Connector (JFP3 / PWR_LED & KEY LOCK).....	77
	Table B.8: Power LED and keyboard lock connector (JFP3 / PWR_LED & KEY LOCK).....	77
B.9	External Speaker Connector (JFP2 / SPEAKER).....	77
	Table B.9: External speaker connector (JFP2 / SPEAKER).....	77
B.10	Reset Connector (JFP1 / RESET).....	77
	Table B.10:Reset connector (JFP1 / RESET).....	77
B.11	HDD LED (JFP2 / HDDLED).....	78
	Table B.11:HDD LED (JFP2 / HDDLED).....	78
B.12	ATX Soft Power Switch (JFP1 / PWR_SW).....	78
	Table B.12:ATX soft power switch (JFP1 / PWR_SW).....	78
B.13	Hi-definition Audio Link Connector (HDAUD1).....	78
	Table B.13:Hi-definition audio link connector (HDAUD1).....	78

B.14	SM Bus Connector (JFP2 / SNMP).....	79
	Table B.14:SM bus connector (JFP2 / SNMP)	79
B.15	LAN1 and LAN2 LED Connector (LANLED1).....	79
	Table B.15:LAN1 and LAN2 LED connector (LANLED1)	79
B.16	GPIO Header (GPIO1).....	80
	Table B.16:GPIO header (GPIO1).....	80
B.17	System I/O Ports.....	81
	Table B.17:System I/O ports.....	81
B.18	DMA Channel Assignments	81
	Table B.18:DMA channel assignments.....	81
B.19	Interrupt Assignments	82
	Table B.19:Interrupt assignments	82
B.20	1st MB Memory Map	82
	Table B.20:1st MB memory map	82
B.21	PCI Bus Map.....	82
	Table B.21:PCI bus map.....	82

Appendix C Programming the GPIO 83

C.1	Supported GPIO Register	84
C.2	GPIO registers	84
C.3	GPIO example program-1	84

Chapter 1

Hardware
Configuration

1.1 Introduction

PCE-5126 is a PICMG 1.3 form-factor single host board which is designed with Intel®B65/Q67/C206 PCH for industrial applications that need high computing power and strong I/O capability. PCE-5126 supports 32nm manufacturing technology, LGA1155 socket Intel® Core™ i7/i5/i3, Pentium® and Xeon™ processors that integrate memory and graphic controllers and supports DDR3 1333 MHz SDRAM up to 16GB. By supporting advanced computing technology, PCE-5126 is suitable for computing power hungry industrial applications.

PCE-5126 performs excellent graphic processing capability by its processor integrated Intel® HD Graphics graphic core with shared memory up to 1GB when 2GB and above system memory installed. With this feature, PCE-5126 can provide strong 2D/3D graphic processing power without a discrete graphic card to save extra cost, power consumption and thermal design effort.

PCE-5126 also has rich I/O interfaces, and it can support Advantech PCE-5XXX and 7XXX backplanes to offer various expansion slots such as PCI, PCI-X and PCIe slots with its PCIe lanes that are configured as one x16 or two x8 and four x1. New SATA Gen3 (600MB/sec) ports meet high data transfer performance applications, like storage and DVR. Six SATA ports support software RAID 0, 1, 5, 10 to be a cost-effective data reliability solution, the two on-board RS-232 serial ports are for COM port based industrial control applications. With flexible I/O and graphic expandability, PCE-5126 can be an excellent, cost effective graphic or I/O oriented workstation class hardware platform.

With outstanding performance and exceptional features, PCE-5126 is the ideal computing platform for advanced industrial applications.

Note!  Only the workstation WG2 SKU Xeon® processors can support Advantech backplanes of PCE-5XXX series and 7XXX series that are with single or dual PCIe x 8 slot(s). WG2 SKU plus processors other than those mentioned above and QG2, QVG SKUs plus all kinds of processors can ONLY support PCE-5XXX series products. Please see table below for detailed information.

Note!  Only PCE-5126WG2-00A1E supports Xeon® E3-12XX processors.

1.2 Features & Benefits

Features	Benefits
Supports Intel's® next generation Core™ i7/i5/i3 Processors.	Intel's next generation Core i7/i5/i3/Pentium/Xeon processor cores with quad/dual-core computing power brings quantum-leap performance improvement.
Supports DDR3 1333MHz SDRAM Max 16GB.	To provide higher memory data transmitting and processing efficiency, bringing higher system performance.
WG2 SKU supports dual PCIe x 8 or one x 16 lane(s) for supporting both PCE-7XXX/5XXX series BPs.	WG2 SKU supports dual PCIe x 8 or one x 16 lane(s) for supporting Advantech backplanes of PCE-5XXX series and 7XXX series that are with single or dual PCIe x 8 slot(s).

WG2 SKU supports ECC DDR3 1333MHz SDRAM.	To provide higher memory data transmitting reliability, suitable for applications that are sensitive to system stability such as medical, industrial server applications.
Fully supports Advantech SUSI APIs and Utilities.	To reduce customer S/W development effort with more reliable S/W quality, also provides value-added utilities such as system monitor and Embedded Security ID.
SATA Gen3	To provide high performance storage interface. SATA Gen3 is 6Gb/s which is double bandwidth with SATA Gen2.

1.3 Specifications

1.3.1 System

- **CPU:** LGA1155-socket Core i7/i5/i3, Pentium and Xeon E3-12XX series processors
- **L2 Cache:** Core™ i7-2600: Maximum 8 MB
Core™ i5-2400: Maximum 6 MB
Core™ i3-2120: Maximum 3 MB
Pentium® G850: Maximum 3 MB
Xeon® E3-12XX: Maximum 8 MB (Only supported by WG2 version)
- **BIOS:** AMI SPI BIOS (64 Mb SPI)
- **System Chipset:** Intel B65/Q67/C206 platform control hub (PCH)
- **SATA hard disk drive interface:** Two SATA3 (600MB/s) are with blue connectors and four SATA2 (300MB/s) are with black connectors. These interfaces can be enabled/disabled in the BIOS.

Note! PCE-5126 does NOT support PATA(IDE) interface.



1.3.2 Memory

- **RAM:**
 - WG2 SKU: Up to 16 GB in two 240-pin DIMM sockets. Supports dual-channel DDR3 1066/1333 MHz SDRAM WITH or WITHOUT ECC function.
 - QVG and QG2 SKUs: Up to 16 GB in two 240-pin DIMM sockets. Supports dual-channel DDR3 1066/1333 MHz SDRAM WITHOUT ECC function.

Note! ONLY WG2 SKU support DDR3 memory module with ECC function, QVG and QG2 can ONLY support those with NO ECC. Wrong memory configuration may cause no boot or system instability problems.



1.3.3 Input/Output

- **Backplane Support:**
Backplane Support Matrix Table:

Model	Backplane
PCE-5126QVG-00A1E	PCE-5XXX
PCE-5126QG2-00A1E	PCE-5XXX
PCE-5126WG2-00A1E	PCE-5XXX and PCE-7XXX (Except PCE-7B10-04A1E)

- **PCI bus:** Four PCI masters to the backplane, 32-bit, 33 MHz PCI 2.2 compliant.
- **Enhanced parallel port:** This EPP/SPP/ECP port can be configured to LPT1, LPT2, LPT3 or disabled. A standard DB-25 female connector provided.
- **Serial ports:** Two RS-232 serial ports
- **PS/2 keyboard and mouse connector:** One 6-pin mini-DIN connectors is located on the mounting bracket for easy connection to a PS/2 keyboard and mouse via the Y-cable included in the package.
- **USB port:** Supports up to 13 USB 2.0 ports with transmission rate up to 480 Mbps. 9 ports are on the CPU card and 4 ports are on the backplane.

1.3.4 Graphics

- **Controller:** Intel® HD Graphics embedded in the processor.
- **Display memory:** Max. 1 GB shared video memory with system memory ≥ 2 GB.
- **CRT:** Up to 2048 x 1536 resolution, 400 MHz RAMDAC.
- **PCI express x16/x8 slot on the backplane:** An external graphic card can be installed in the PCI-E x 16/ x 8 slot for stronger 2D/3D graphic capability.

1.3.5 Ethernet LAN

- Supporting single/dual 10/100/1000 Mbps Ethernet port(s) via the dedicated PCI Express x1 bus which provides 500 MB/s data transmission rate.
- **Controller:**
 - LAN 1: Intel® 82579LM for all SKUs.
 - LAN 2: Intel® 82583V for QG2 SKU; Intel 82574L for WG2 SKU.

1.3.6 Industrial features

- **Watchdog timer:** Can generate a system reset. The watchdog timer is programmable, with each unit equal to one second or one minute (255 levels).

1.3.7 Mechanical and environmental specifications

- **Operating temperature:** 0 ~ 60° C (32 ~ 140° F, Depending on CPU)
- **Storage temperature:** -40 ~ 85° C (-40 ~ 185° F)
- **Humidity:** 20 ~ 95% non-condensing
- **Power supply voltage:** +3.3 V, +5 V, +12 V, +5 V_{SB}
- **Power consumption:** Processor: Intel Core i7-2600; Memory: 2 DDR3 1333 MHz 2 GB DIMMs

Voltage	+12 V	+5 V	+3.3 V	+5 V _{SB}
Current	6.65A	1.62A	1.98A	0.73A
- **Board size:** 338.58 mm (L) x 126.39 mm (W) (13.3" x 4.98")
- **Board weight:** 0.490 kg

1.4 Jumpers and Connectors

Connectors on the PCE-5126 single host board link it to external devices such as hard disk drives and a keyboard. In addition, the board has a number of jumpers used to configure your system for your application.

The tables below list the function of each of the board jumpers and connectors. Later sections in this chapter give instructions on setting jumpers. Chapter 2 gives instructions for connecting external devices to your motherboard.

Table 1.1: Jumper list

Label	Function
JCMOS1	CMOS clear
JMECLR1	ME setup clear
JWDT1	Watchdog Reset
JOBS1	HW Monitor Alarm

Table 1.2: Connector list

Label	Function
LPT1	Parallel port, Parallel port x 1, supports SPP/EPP/ECP mode
LAN1	Intel 82579LM for all SKUs
LAN2	LAN 2: Intel 82583V for QG2 SKU; Intel 82574L for WG2 SKU
VGA1	VGA connector
KBMS1	PS/2 keyboard and mouse connector
KBMS2	External keyboard/mouse connector
COM1	Serial port: COM1; RS-232 (Box Header)
COM2	Serial port: COM2; RS-232 (Box Header)
JIR1	Infrared connector
JFP1	Power Switch / Reset connector
JFP2	External speaker / SATA HDD LED connector
JFP3 (Keyboard Lock and Power LED)	Suspend: Fast flash (ATX/AT) System On: ON (ATX/AT) System Off: OFF (AT) System Off: Slow flash (ATX)
JCASE1	Case Open
CPUFAN1	CPU FAN connector (4-pin)
LANLED1	LAN1/2 LED extension connector
HDAUD1	Connector for HD audio extension module
USB12	USB port 1, 2
USB34	USB port 3, 4
USB56	USB port 5, 6
USB78	USB port 7, 8
USB9	USB port 9
SATA1	Serial ATA1
SATA2	Serial ATA2
SATA3	Serial ATA3
SATA4	Serial ATA4
SATA5	Serial ATA5
SATA6	Serial ATA6

Table 1.2: Connector list

Label	Function
CPU1	CPU Socket
DIMMA1	Memory connector channel A
DIMMB1	Memory connector channel B
GPIO1	GPIO pin header (SMD pitch-2.0 mm)
LPC1	COM port module expansion pin-header

1.5 Board Layout: Jumper and Connector Locations

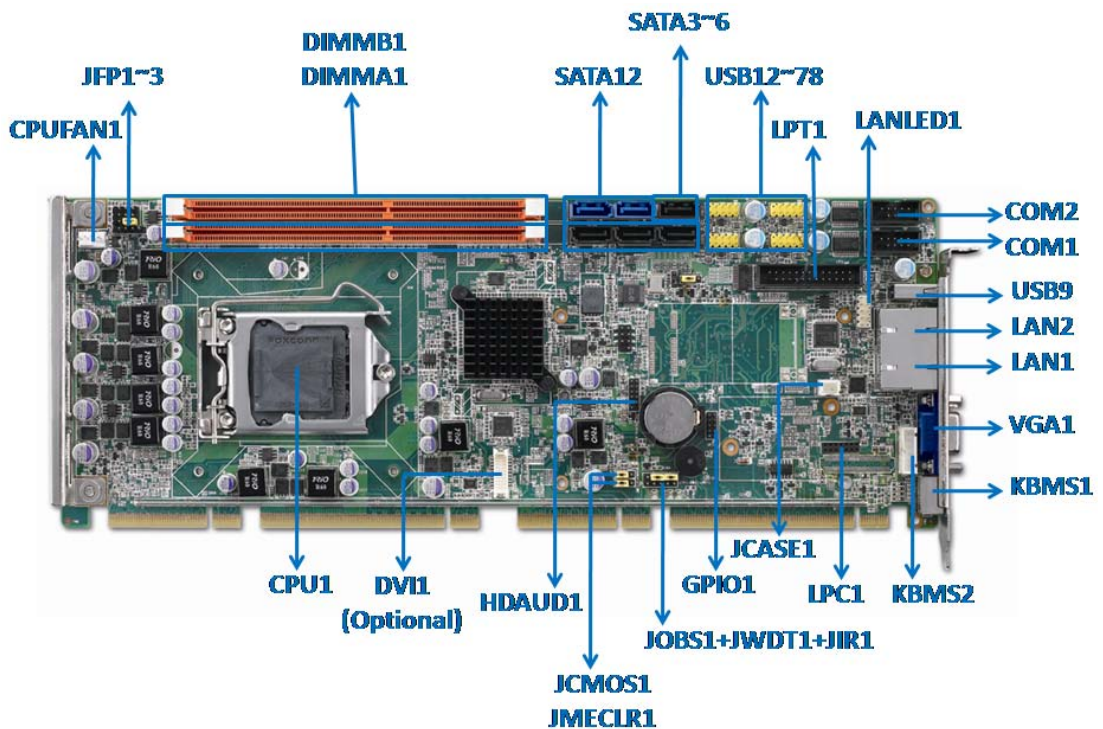

Figure 1.1 Jumper and connector locations

1.6 PCE-5126 Block Diagram

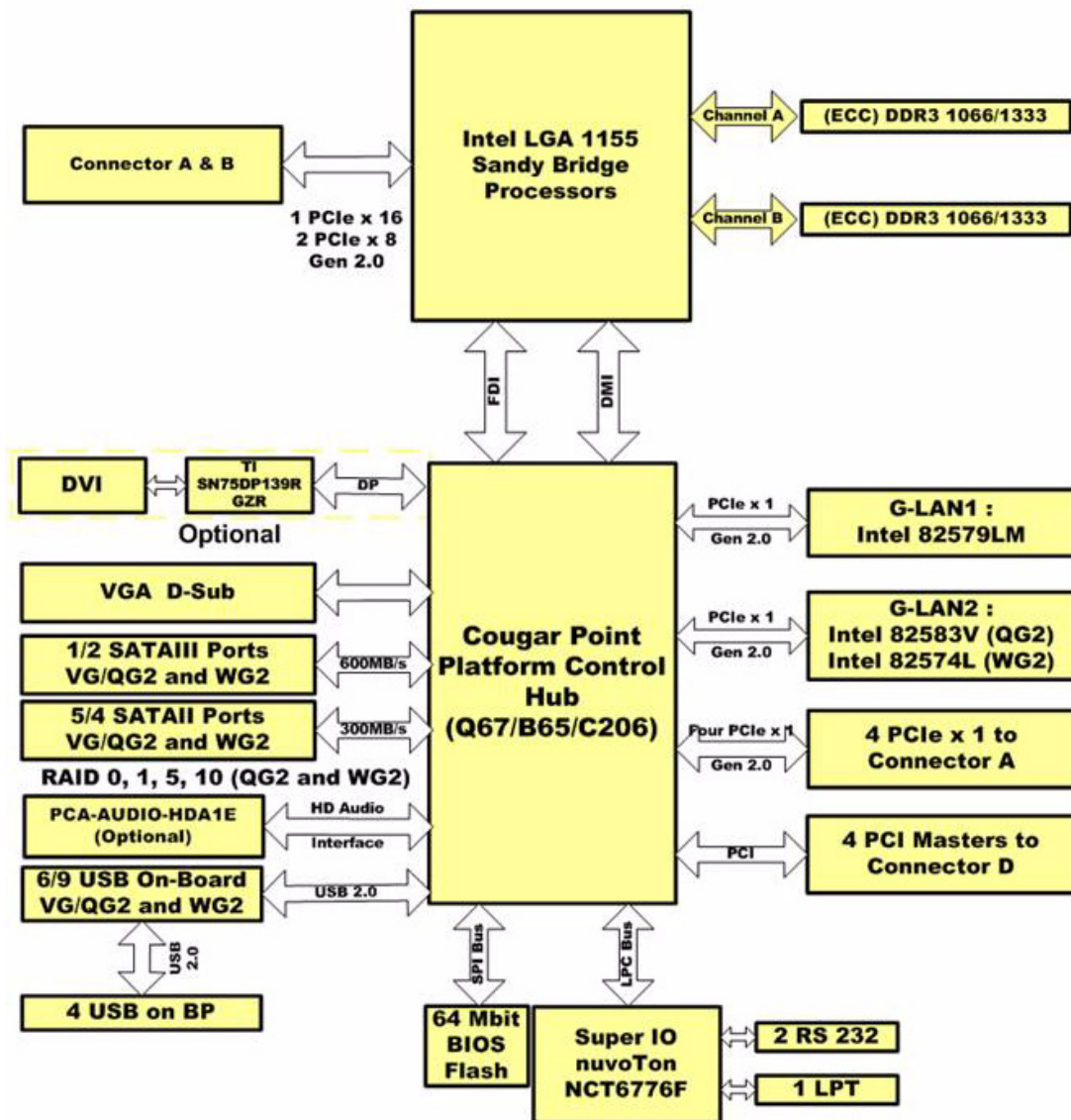

Figure 1.2 PCE-5126 block diagram

1.7 Safety Precautions

Warning! Always completely disconnect the power cord from your chassis whenever you work with the hardware. Do not make connections while the power is on. Sensitive electronic components can be damaged by sudden power surges. Only experienced electronics personnel should open the PC chassis.



Caution! Always ground yourself to remove any static charge before touching the motherboard. Modern electronic devices are very sensitive to static electrical discharges. As a safety precaution, use a grounding wrist strap at all times. Place all electronic components on a static-dissipative surface or in a static-shielded bag when they are not in the chassis.



Caution! The computer is provided with a battery-powered Real-time Clock. There is a danger of explosion if battery is incorrectly replaced. Replace only with same or equivalent type recommended by the manufacturer. Discard used batteries according to manufacturer's instructions.



Caution! There is a danger of a new battery exploding if it is incorrectly installed. Do not attempt to recharge, force open or heat the battery. Replace the battery only with the same or equivalent type recommended by the manufacturer. Discard used batteries according to the manufacturer's instructions.



1.8 Jumper Settings

This section provides instructions on how to configure your motherboard by setting the jumpers. It also includes the motherboard's default settings and your options for each jumper.



1.8.1 How to set jumpers

You can configure your motherboard to match the needs of your application by setting the jumpers. A jumper is a metal bridge that closes an electrical circuit. It consists of two metal pins and a small metal clip (often protected by a plastic cover) that slides over the pins to connect them. To “close” (or turn ON) a jumper, you connect the pins with the clip. To “open” (or turn OFF) a jumper, you remove the clip. Sometimes a jumper consists of a set of three pins, labeled 1, 2 and 3. In this case you connect either pins 1 and 2, or 2 and 3. A pair of needle-nose pliers may be useful when setting jumpers.

1.8.2 BIOS CMOS/ME data clear (JCMOS1/JMECLR1)

The PCE-5126 CPU card contains a jumper that can erase BIOS CMOS data and ME (Intel Management Engine) data and reset the system BIOS information. Normally this jumper should be set with pins 1-2 closed. If you want to reset those data, set JCMOS1/JMECLR1 to 2-3 closed for just a few seconds, and then move the jumper back to 1-2 closed. This procedure will reset the CMOS to its last status or default setting.

Table 1.3: Clear BIOS CMOS/ME Data (JCMOS1/JMECLR1)

Function	Jumper Setting
*Keep BIOS CMOS/ME data	<p>1</p>  1-2 closed
Clear BIOS CMOS/ME data	<p>1</p>  2-3 closed

* default setting

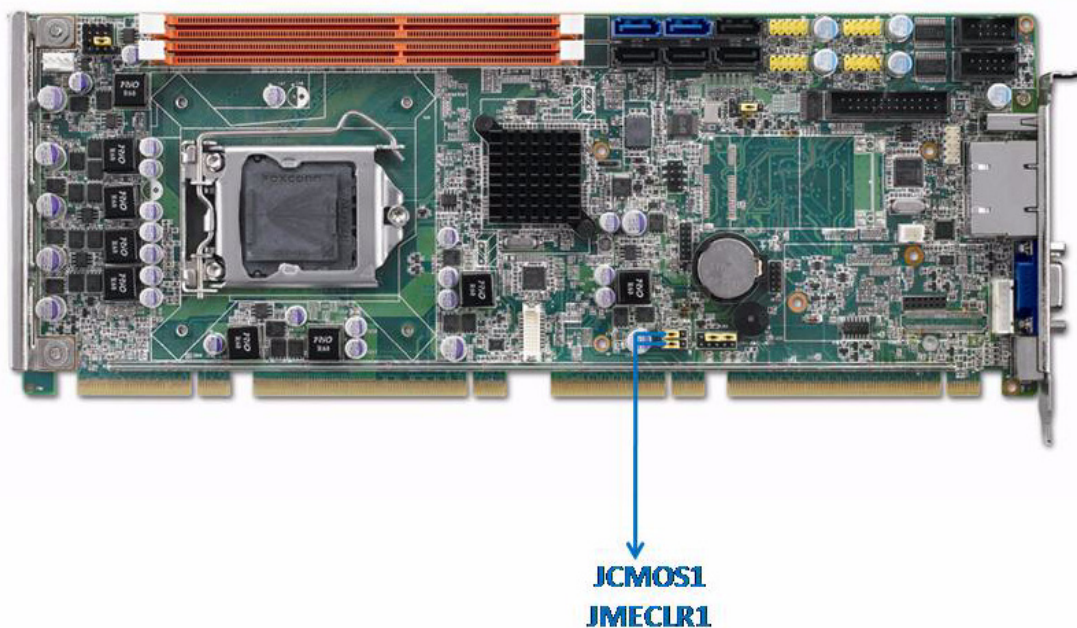

1.8.3 Watchdog timer output (JWDT1)

The PCE-5126 contains a watchdog timer that will reset the CPU in the event the CPU stops processing. This feature means the PCE-5126 will recover from a software failure or an EMI problem. The JWDT1 jumper settings control the outcome of what the computer will do in the event the watchdog timer is tripped.

Table 1.4: Watchdog timer output (JWDT1)

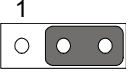
Function	Jumper Setting
* Reset	 1-2 closed
*default setting	

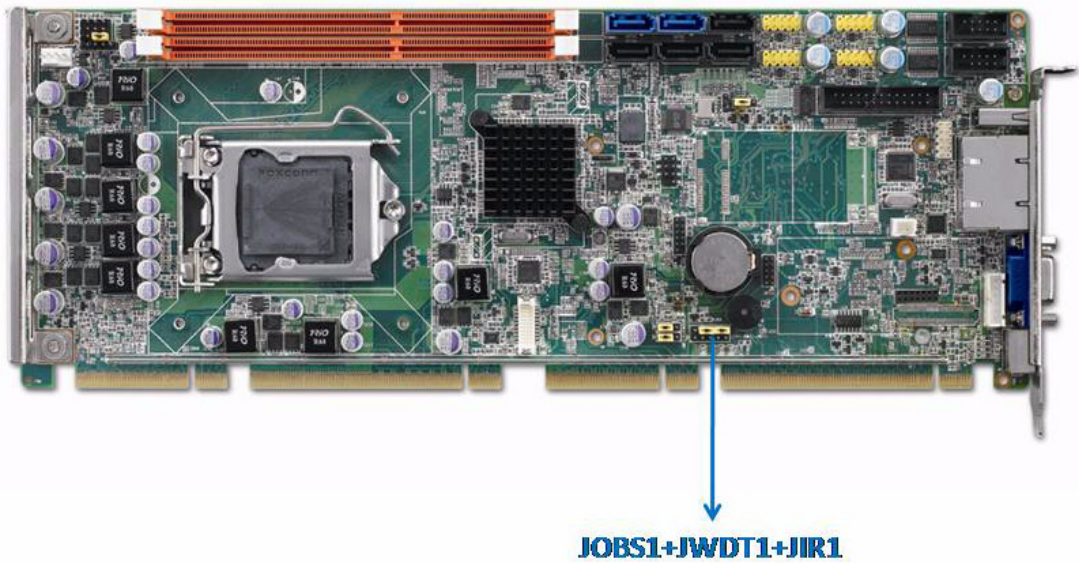



Table 1.5: H/W monitor alarm (JOBS1)

Function	Jumper Setting
Enabled	 1-2 closed
Disabled	 1-2 opened

(JOBS1) is a 2-pin connector for setting enable/disable alarm while the on-board security event acts.

1.9 System Memory

PCE-5126 has two 240-pin memory sockets for (ECC) DDR3 1066/1333 MHz memory modules with maximum capacity of 8GB. (Maximum 4GB for each DIMM)
 PCE-5126 QG2 and QVG SKUs support non-ECC DDR3 memory modules.
 PCE-5126 WG2 SKU supports ECC and non-ECC DDR3 memory modules.
 Please be noted that PCE-5126 does NOT support registered DIMMs (RDIMMs).

1.10 Memory Installation Procedures

To install DIMMs, first make sure the two handles of the DIMM socket are in the “open” position. i.e. the handles lean outward. Slowly slide the DIMM module along the plastic guides on both ends of the socket. Then press the DIMM module right down into the socket, until you hear a click. This is when the two handles have automatically locked the memory module into the correct position of the DIMM socket. To remove the memory module, just push both handles outward, and the memory module will be ejected by the mechanism in the socket.

Note! *Because PCE-5126 supports Intel Active Management Technology 7.0 (iAMT7.0) which utilizes some memory space of channel 0, it's suggested that the user should not leave channel 0 DIMM slots (DIMMA1) empty, or it may cause some system abnormality.*



1.11 Cache Memory

CPUs supported by PCE-5126 have 8 MB, 6 MB, 3 MB L2 cache memory sizes.

1.12 Processor Installation

Warning! *Without a fan or heat sink, the processor will overheat and cause damage to both the processor and the single board computer. To install a processor, first turn off your system.*



The PCE-5126 is designed for Intel® LGA 1155 socket processors.

1. Pull the bar beside the processor socket outward and lift it.

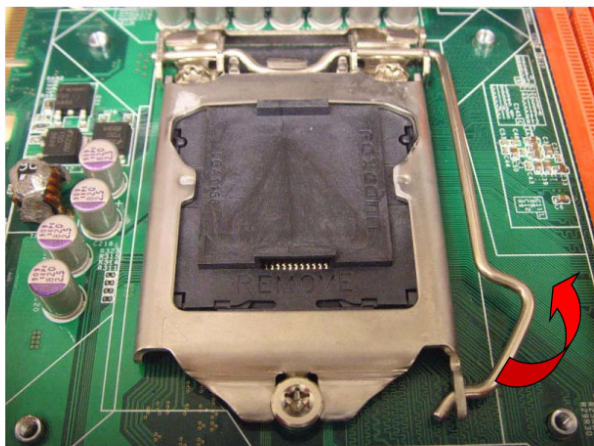

2. Remove the socket protection cap.

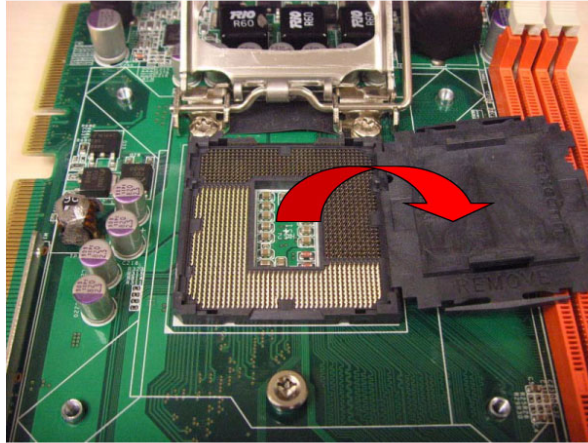

3. Align the cuts on the processor with the edges of the socket.

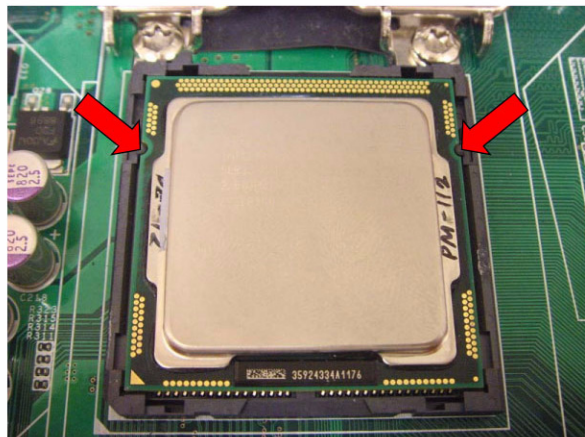

4. Replace the socket cap; lower the retainer bar and clip it shut.

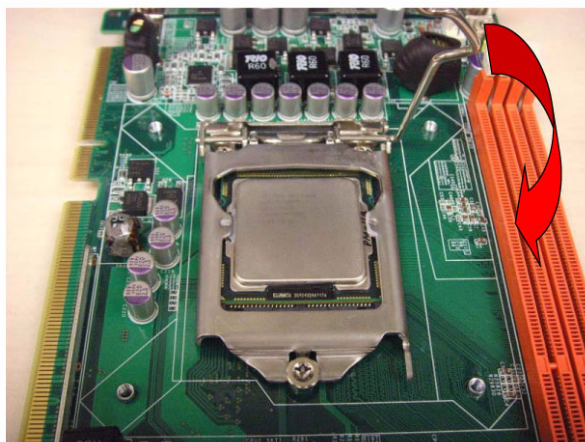

5. Finished processor installation.

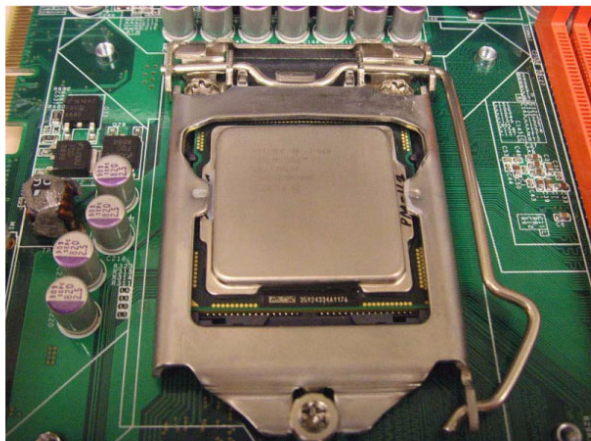

1.13 Processor Cooler Installation

Purchasing PCE-5126's proprietary CPU cooler (P/N: 1960047831N001) from Advantech is a must. Other brand CPU coolers are NOT compatible with PCE-5126.

Advantech offers a specially designed CPU cooler for PCE-5126 for better heat dissipation efficiency and enhancing rigidity of CPU card, part number 1960047831N001. Buy it for PCE-5126 CPU card since it is NOT compatible with other brand CPU coolers (neither is it compatible with Intel boxed CPU cooler).

Please install 1960047831N001 CPU cooler following these instructions:

Attach the CPU cooler on CPU card by fastening four screws of the CPU cooler into the steel back-plate on PCB.



Note the direction of CPU cooler; it must follow that shown above. Installing a CPU cooler in the wrong direction may cause poor heat dissipation that may damage the CPU card.

Chapter 2

Connecting
Peripherals

2.1 Introduction

You can access most of the connectors from the top of the board. If you have a number of cards installed, you may need to partially remove the card to make all the connections.

2.2 Parallel Port (LPT1)

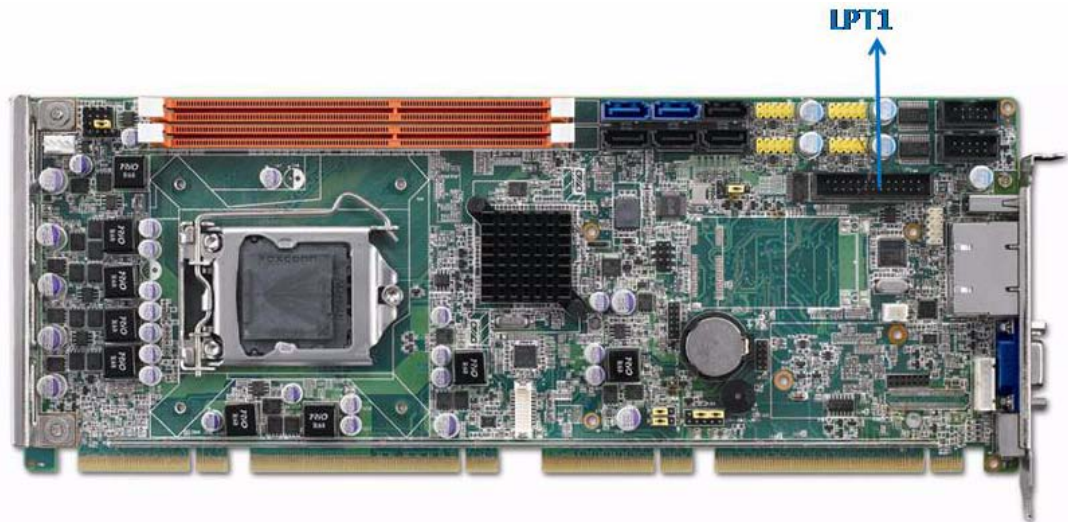

The parallel port is normally used to connect the motherboard to a printer. The PCE-5126 includes an onboard parallel port, accessed through a 26-pin flat-cable connector, LPT1.

2.3 USB Ports (USB12, USB34, USB56, USB78)

The PCE-5126 provides up to 9 USB (Universal Serial Bus) on-board ports with complete Plug & Play and hot swap support for up to 127 external devices. These USB ports comply with USB Specification Rev. 2.0, support transmission rates up to 480 Mbps and are fuse protected. The USB interface can be disabled in the system BIOS setup.

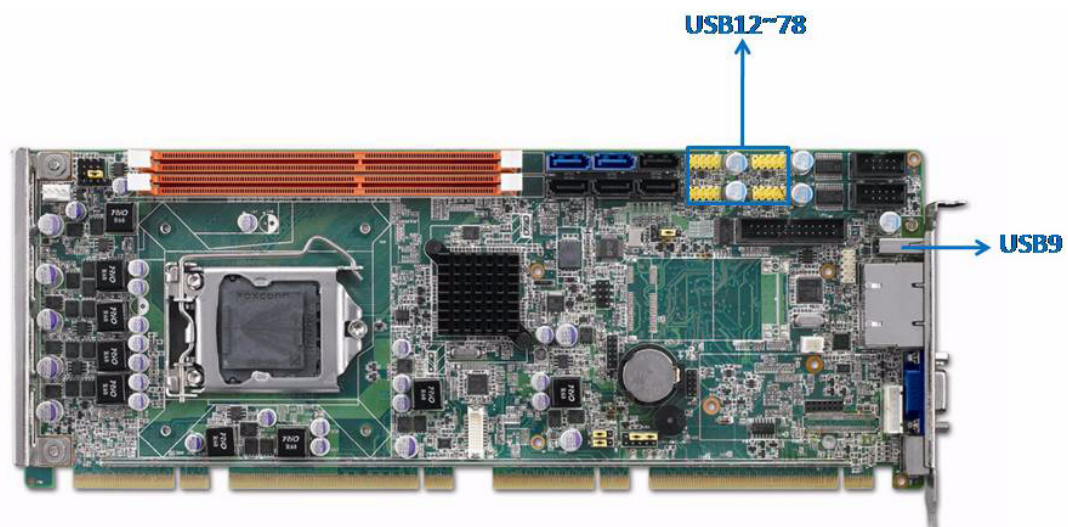

2.4 VGA Connectors (VGA1)

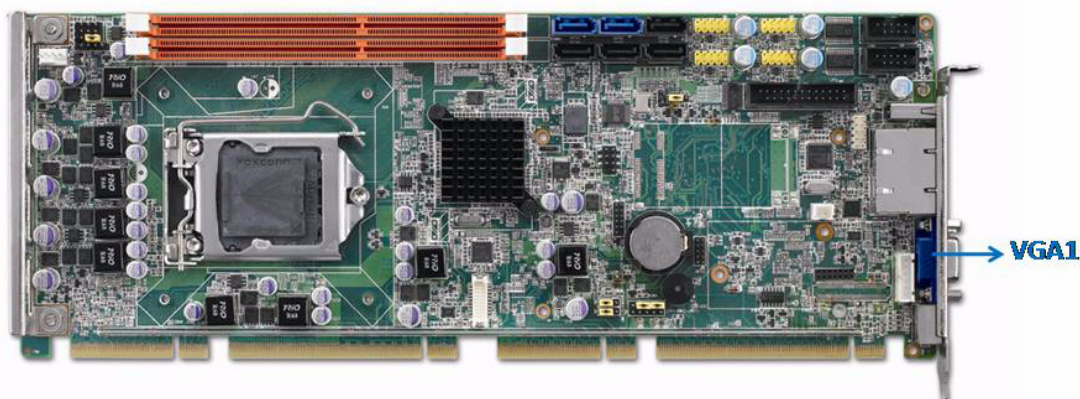

The PCE-5126 has VGA outputs that can drive conventional CRT displays. VGA1 is a standard 15-pin D-SUB connector commonly used for VGA.

2.5 Serial Ports (COM1 & COM2)

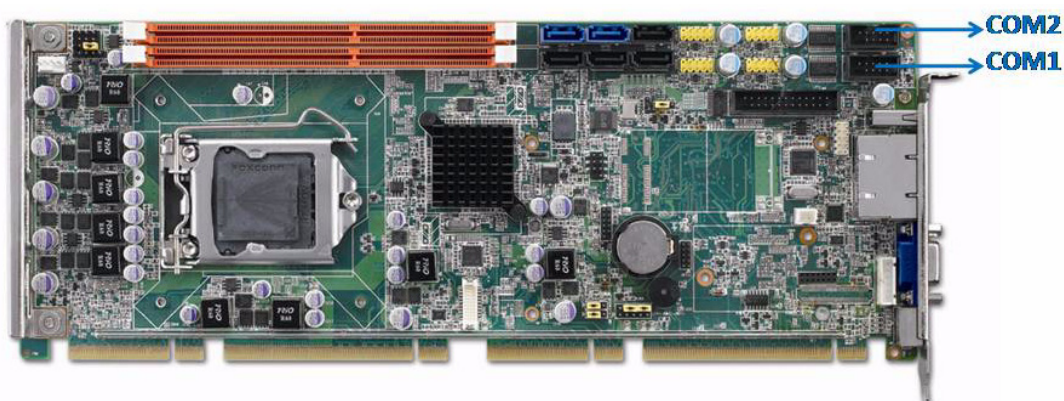

The PCE-5126 offers two serial ports. These ports can connect to serial devices, such as a mouse or a printer, or to a communications network.

The IRQ and address ranges for both ports are fixed. However, if you want to disable the port or change these parameters later, you can do this in the system BIOS setup. You can purchase dual COM cable kit if you are a QVG, QG2 or WG2 user and want to use dual COM ports. The P/N is 1701092300.

2.6 PS/2 Keyboard and Mouse Connector (KBMS1/KBMS2)

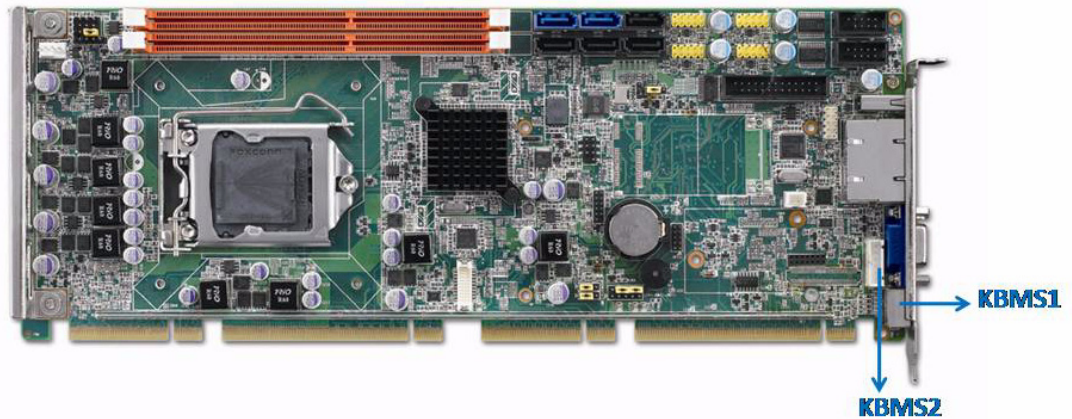

Two on-board 6-pin mini-DIN connectors (KBMS1) provide connection to PS/2 keyboard and mouse by the Y-cable (1700060202) in the package.

The on-board KBMS2 pin header provides connection the front panel PS/2 keyboard and mouse connector of the chassis.

2.7 CPU Fan Connector (CPUFAN1)

This connector supports cooling fans of 500 mA (6 W) or less, and it also supports smart fan control when using 4-pin cooler.

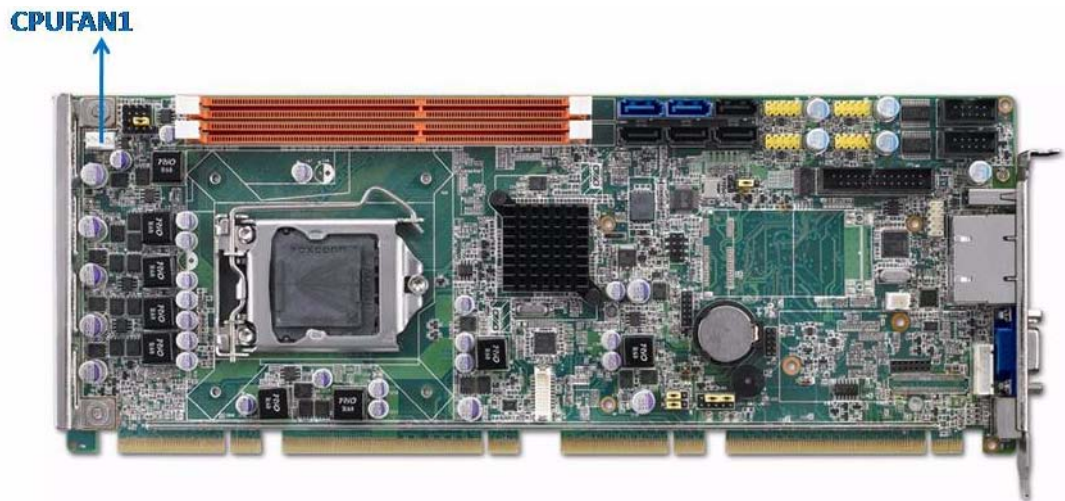

2.8 Front Panel Connectors (JFP1, JFP2 & JFP3)

There are several external switches to monitor and control the PCE-5126.

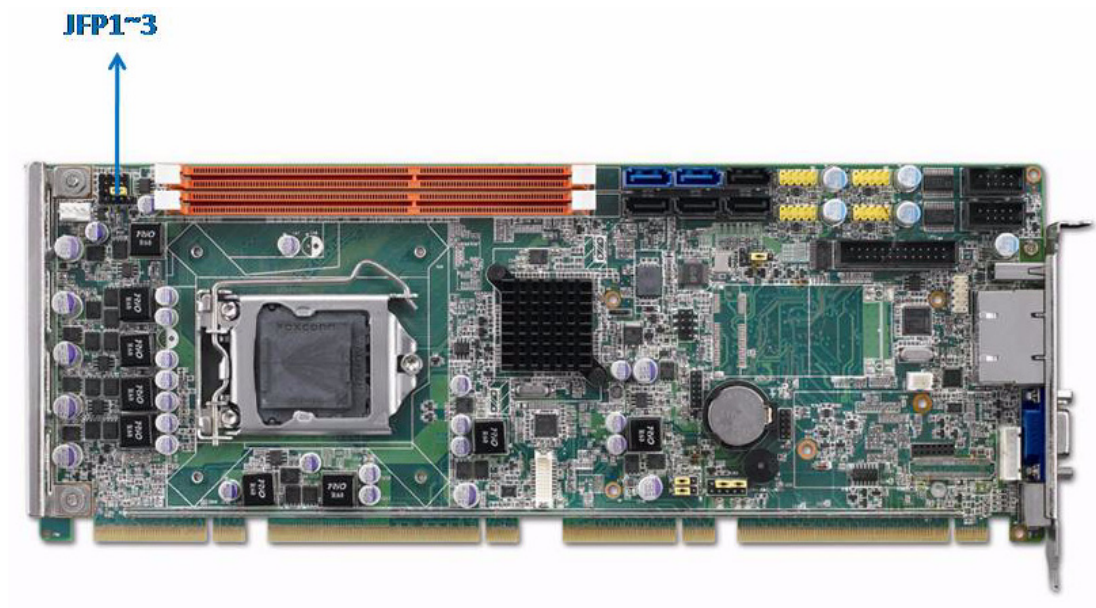

2.8.1 Power LED and keyboard lock (JFP3)

JFP3 is a 5-pin connector for the power LED. Refer to Appendix B for detailed information on the pin assignments. If a PS/2 or ATX power supply is used, the system's power LED status will be as indicated below:

Table 2.1: PS/2 or ATX power supply LED status

Power mode	LED (PS/2 power)	LED (ATX power)
System On	On	On
System Suspend	Flashes	Flashes
System Off	Off	Off



2.8.2 External speaker (JFP2)

JFP2 is a 4 -pin connector for an external speaker. The PCE-512 6 provides an onboard buzzer as an alternative to an external speaker. To enable the buzzer, set pins 3 and 4 as closed.

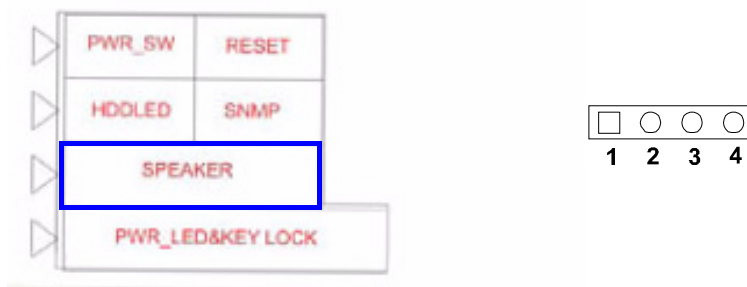

2.8.3 Reset connector (JFP1)

Many computer cases offer the convenience of a reset button. Connect the wire from the reset button.

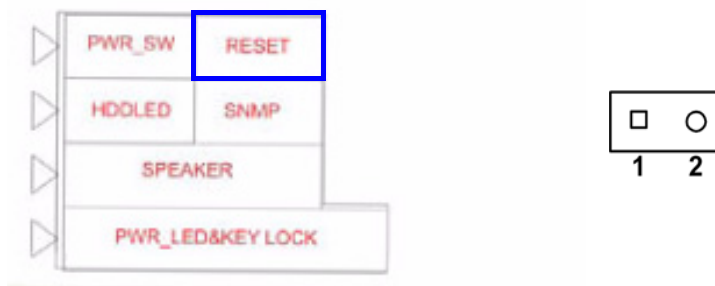

2.8.4 HDD LED connector (JFP2)

You can connect an LED to connector JFP2 to indicate when the HDD is active.

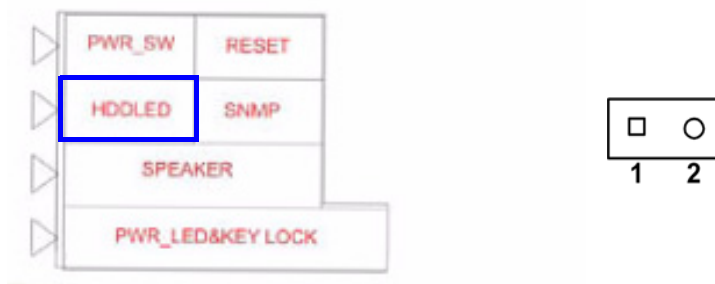

2.8.5 ATX soft power switch (JFP1)

If your computer case is equipped with an ATX power supply, you should connect the power on/off button on your computer case to JFP1. This connection enables you to turn your computer on and off.



2.9 H/W Monitor/Watchdog Timer/Infrared

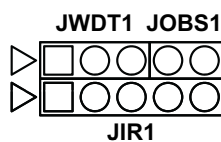
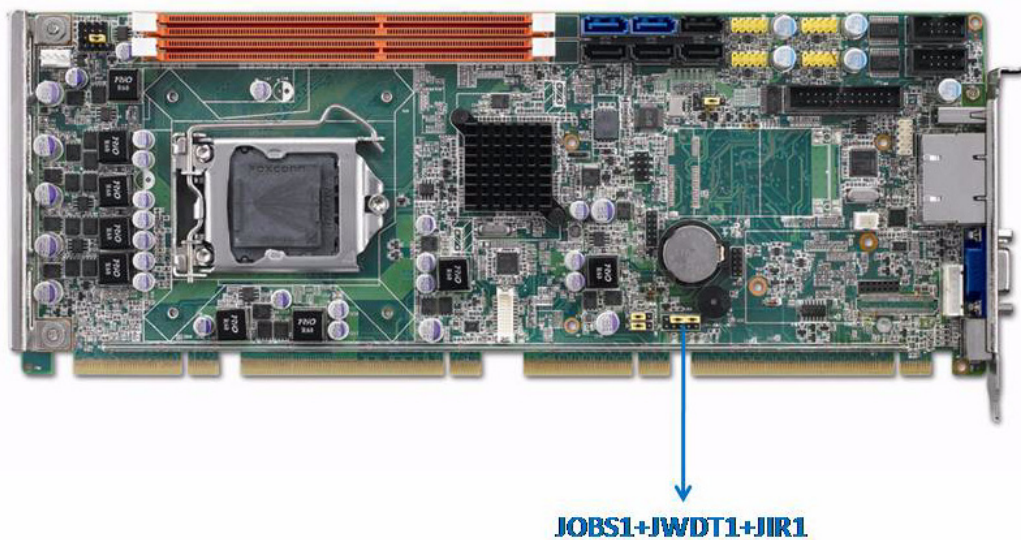

2.9.1 H/W Monitor Alarm (JOBS1)

This 2-pin header is for enabling/disabling H/W monitor alarm function.

Closed: Enables OBS Alarm

Open: Disables OBS Alarm

2.9.2 Watchdog Timer (JWDT1)

This is for setting action trigger by watchdog timer.

1-2 Pin Close: No Action

2-3 Pin Close: System Reset

2.9.3 Infrared Interface (JIR1)

This is a 5-pin header for an infrared device.

2.10 LAN Ports (LAN1 & LAN2)

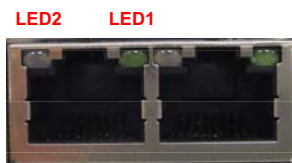
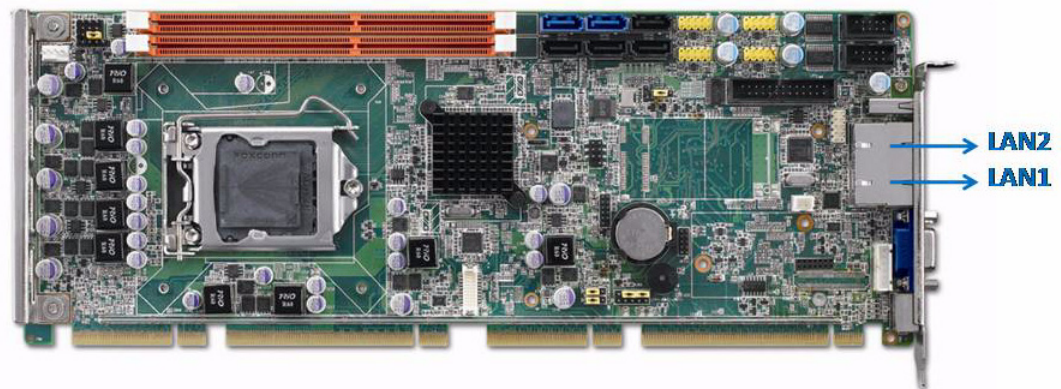

The PCE-5126 is equipped with one or two high-performance 1000 Mbps Ethernet LANs. They are supported by all major network operating systems. The RJ-45 jacks on the rear plate provide convenient connectivity.

Table 2.2: LAN LED Indicators

LAN Mode	LED1	LED2
1000Mbps Link On	Green On	On
1000Mbps Active	Green on	Flash
1000Mbps Link Off	Off	Off
100Mbps Link On	Orange On	On
100Mbps Active	Orange On	Flash
100Mbps Link Off	Off	Off
10Mbps Link On	Off	On
10Mbps Active	Off	Flash
10Mbps Link Off	Off	Off

2.11 High Definition Audio Module Interface (HDAUD1)

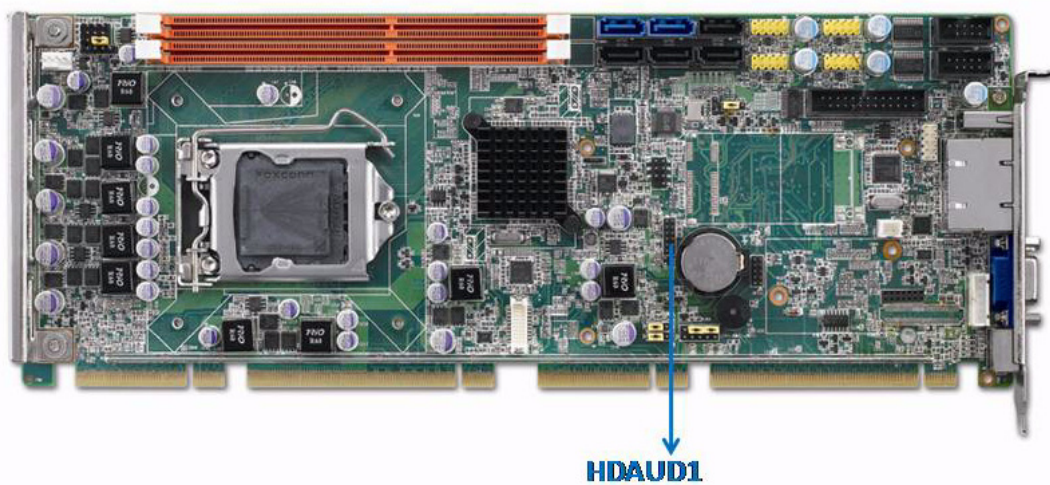

This HDAUD1 pin header is the connection interface to Advantech's 7.1 channel high definition audio module.

Note! Advantech 7.1 channel high definition audio module ordering information.



P/N: PCA-AUDIO-HDA1E

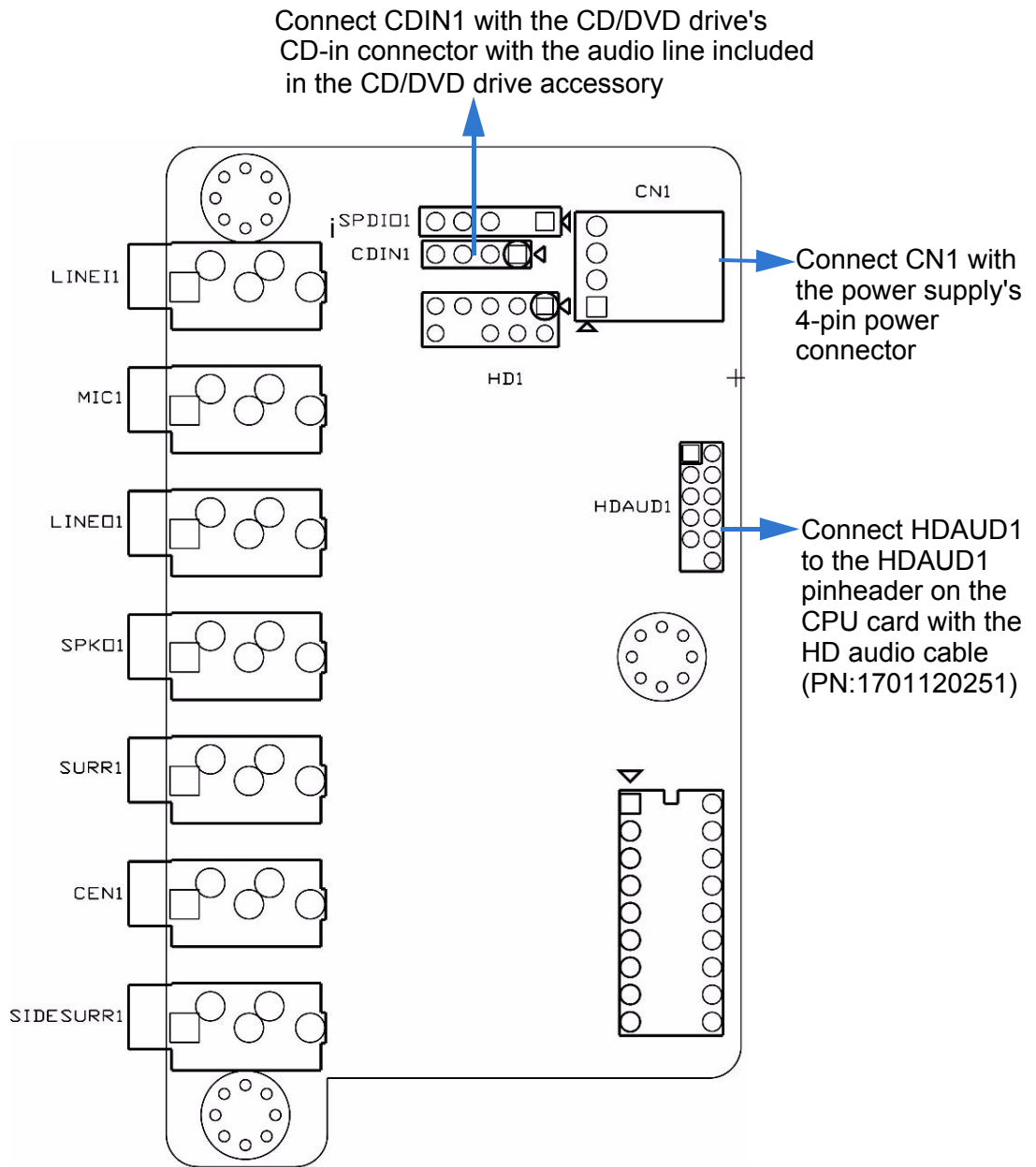
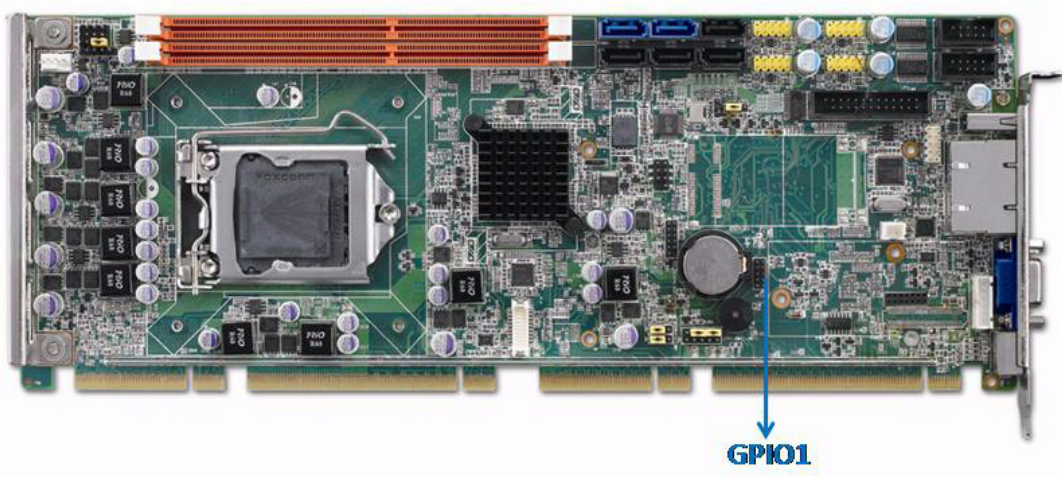

Figure 2.1 Jumper and connector locations of PCA-AUDIO-HDA1E

Note! Please remove the yellow jumper cap on the CPU card's HDAUD1 pinheader before connecting the HD audio cable to it.



2.12 GPIO Header (GPIO1)



Provides 14-Pin pin header for 8-bit Digital I/O usage. Refer to Appendix B for detailed information on the pin assignments and programming guide in Appendix C.

2.13 Case Open Connector (JCASE1)

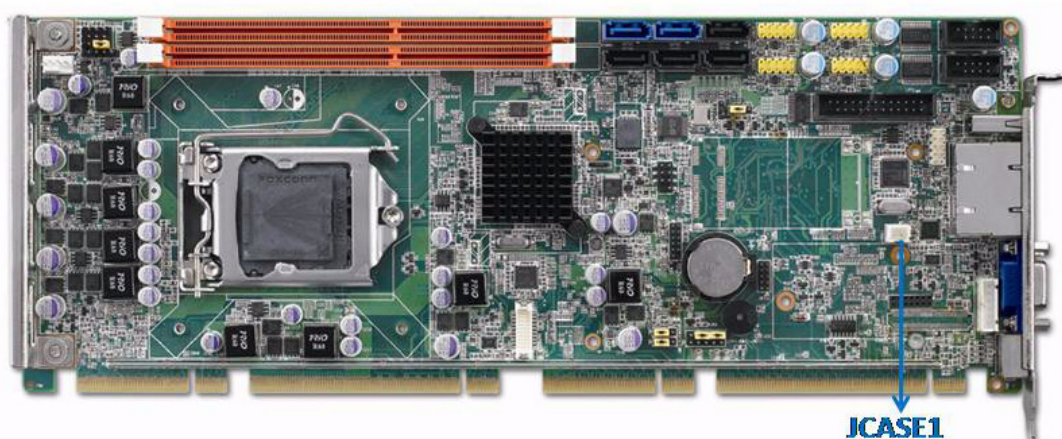

The 2-pin case open connector is for chassis with a case open sensor. When the case is open, the buzzer on motherboard will beep.

2.14 Front Panel LAN Indicator Connector (LANLED1)

Table 2.3: LAN LED Indicators

LAN Mode	LED1	LED2
1000Mbps Link On	Green On	On
1000Mbps Active	Green on	Flash
1000Mbps Link Off	Off	Off
100Mbps Link On	Orange On	On
100Mbps Active	Orange On	Flash
100Mbps Link Off	Off	Off
10Mbps Link On	Off	On
10Mbps Active	Off	Flash
10Mbps Link Off	Off	Off

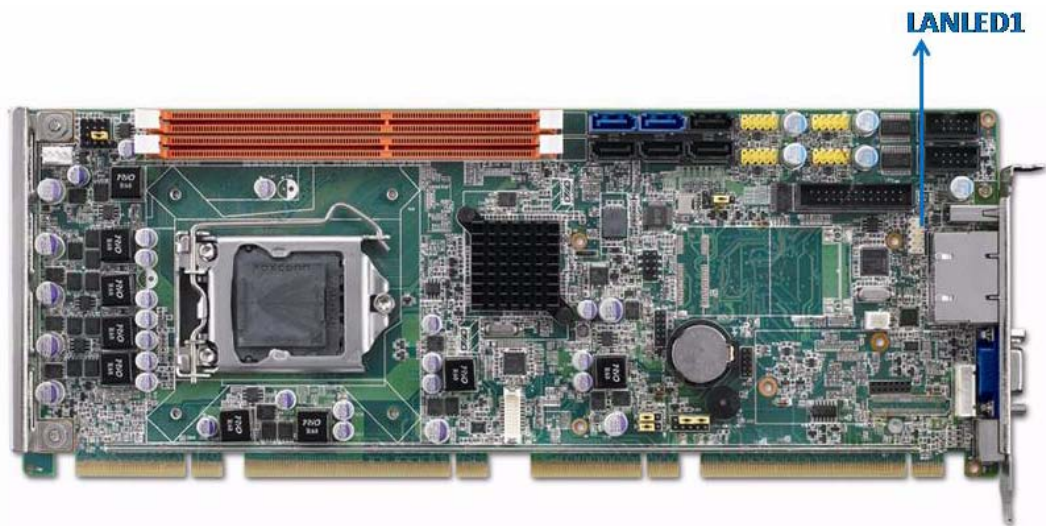

2.15 Serial ATA Interface (SATA1~SATA6)

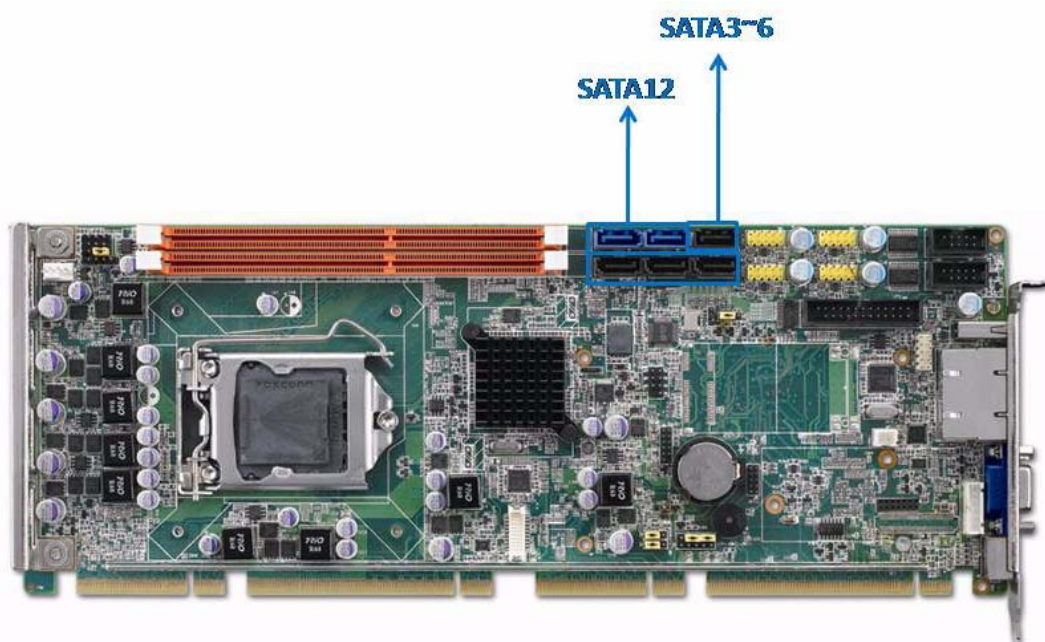

The PCE-5126 features high performance serial ATA interface (2* 600MB/s and 4* 300MB/s) which eases cabling to hard drivers or CD/DVD drivers with long cables.

These six on-board SATA ports can be configured as RAID 0, 1, 10, or 5. Please see the detailed BIOS setting instructions for this in Chapter 3.

Note! We recommend to plug CD/DVD drives on SATA3~6.



When you install Linux OS, we recommend you to set AHCI mode in BIOS setting. It may recognize no hard drives when you use IDE mode during Linux OS installation.

2.16 LPC Extension Interface (LPC1)

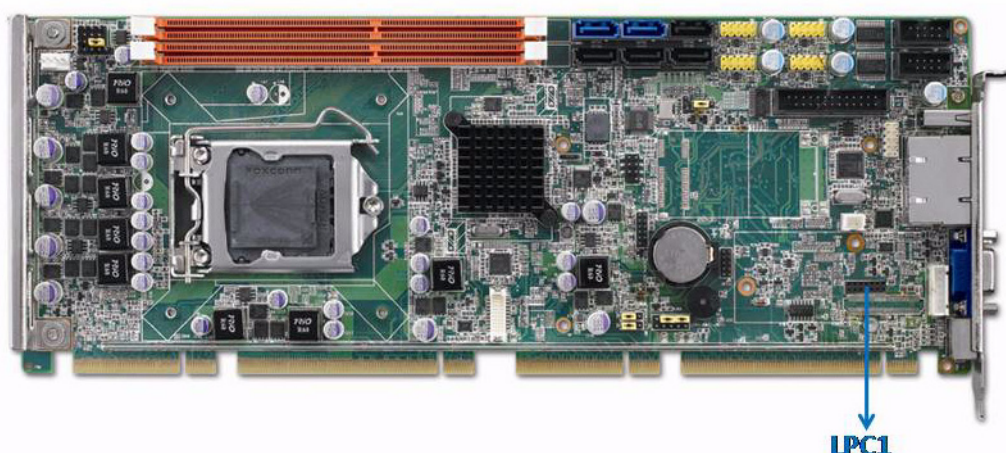

LPC1 is a 4 -pin female pinheader for adopting Advantech proprietary COM port extension module PCA-COM485-00A1E which features four extra COM ports (serial ports) supporting RS-422/485 with auto flow control function.

Chapter 3

AMI BIOS Setup

3.1 Introduction

AMIBIOS has been integrated into motherboards for over a decade. In the past, people often referred to the AMIBIOS setup menu as BIOS, BIOS setup or CMOS setup. With the AMIBIOS Setup program, you can modify BIOS settings and control the special features of your computer. The Setup program uses a number of menus for making changes and turning the special features on or off. This chapter describes the basic navigation of the PCE-5126 setup screens.

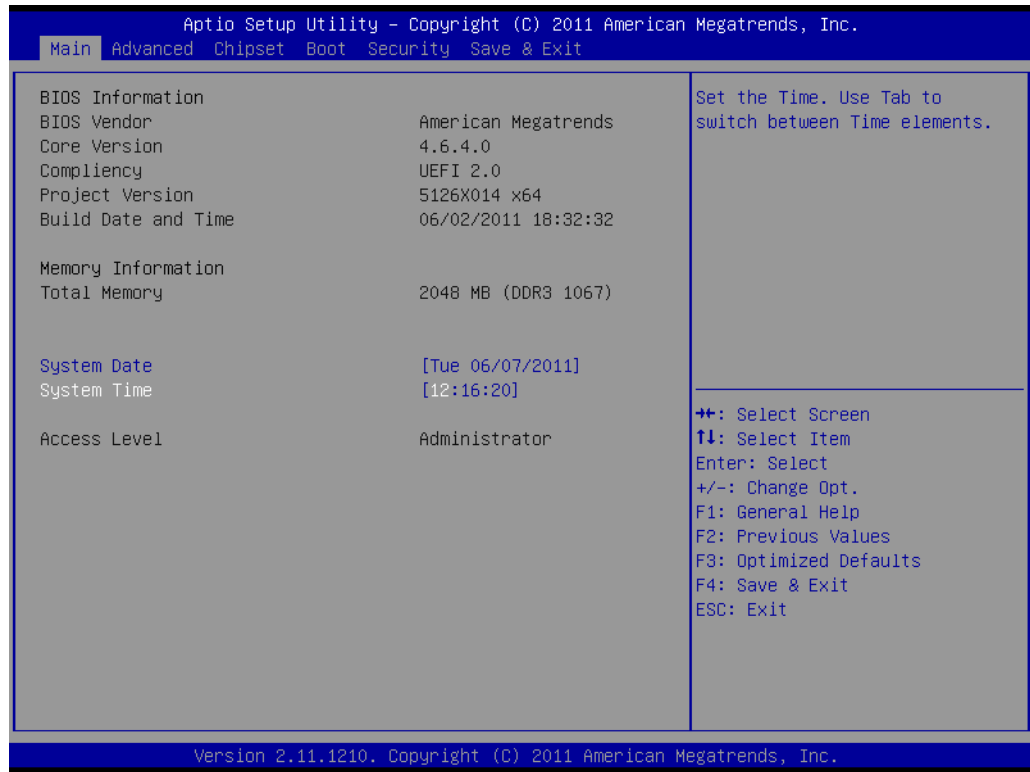

Figure 3.1 Setup program initial screen

AMI's BIOS ROM has a built-in Setup program that allows users to modify the basic system configuration. This type of information is stored in battery-backup CMOS so it retains the Setup information when the power is turned off.

3.2 Entering Setup

Turn on the computer and check for the “patch” code. If there is a number assigned to the patch code, it means that the BIOS supports your CPU. If there is no number assigned to the patch code, please contact an Advantech application engineer to obtain an up-to-date patch code file. This will ensure that your CPU’s system status is valid. After ensuring that you have a number assigned to the patch code, press and you will immediately be allowed to enter Setup.

3.2.1 Main Setup

When you first enter the BIOS Setup Utility, you will enter the Main setup screen. You can always return to the Main setup screen by selecting the Main tab. There are two Main Setup options. They are described in this section. The Main BIOS Setup screen is shown below.

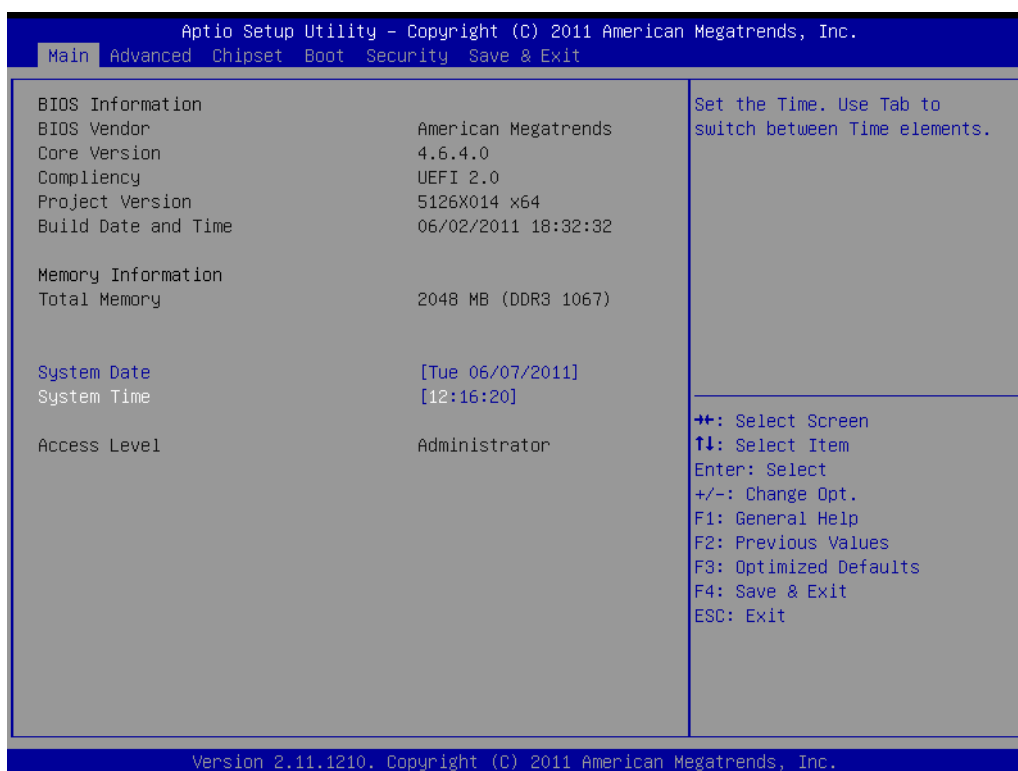

Figure 3.2 Main setup screen

The Main BIOS setup screen has two main frames. The left frame displays all the options that can be configured. Grayed-out options cannot be configured; options in blue can. The right frame displays the key legend.

Above the key legend is an area reserved for a text message. When an option is selected in the left frame, it is highlighted in white. Often a text message will accompany it.

3.2.1.1 System Time / System Date

Use this option to change the system time and date. Highlight System Time or System Date using the <Arrow> keys. Enter new values through the keyboard. Press the <Tab> key or the <Arrow> keys to move between fields. The date must be entered in MM/DD/YY format. The time must be entered in HH:MM:SS format.

3.2.2 Advanced BIOS Features Setup

Select the Advanced tab from the PCE-5126 setup screen to enter the Advanced BIOS Setup screen. You can select any of the items in the left frame of the screen, such as CPU Configuration, to go to the sub menu for that item. You can display an Advanced BIOS Setup option by highlighting it using the <Arrow> keys. All Advanced BIOS Setup options are described in this section. The Advanced BIOS Setup screen is shown below. The sub menus are described on the following pages.

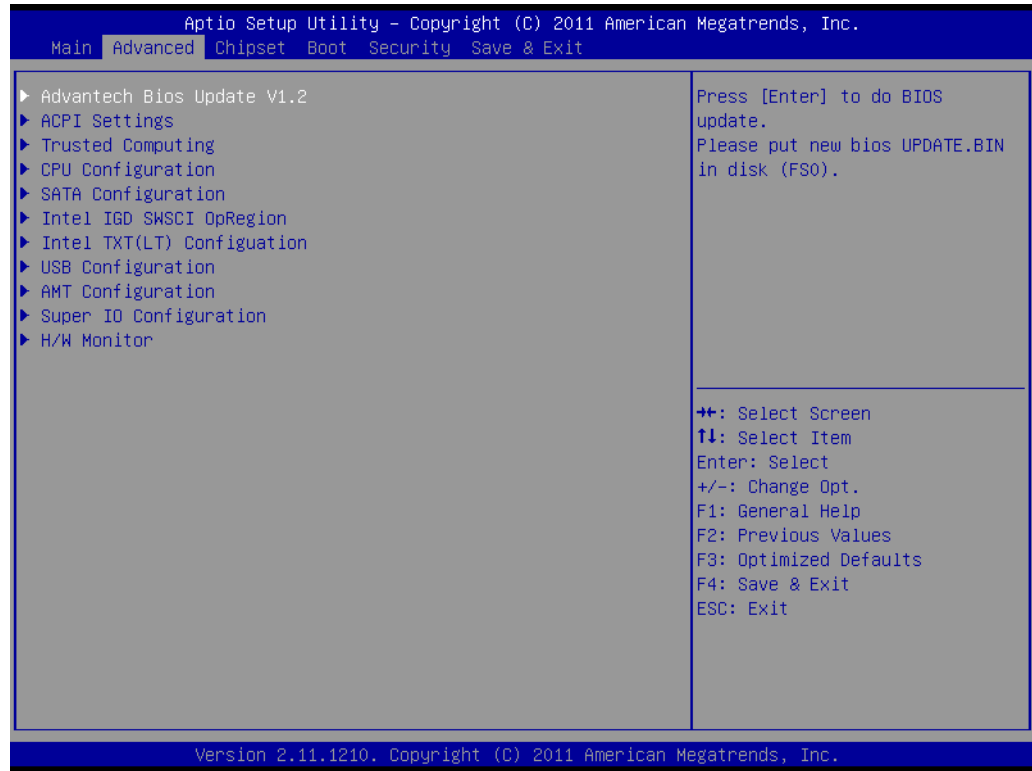

Figure 3.3 Advanced BIOS features setup screen

3.2.2.1 Advantech BIOS Update V1.2

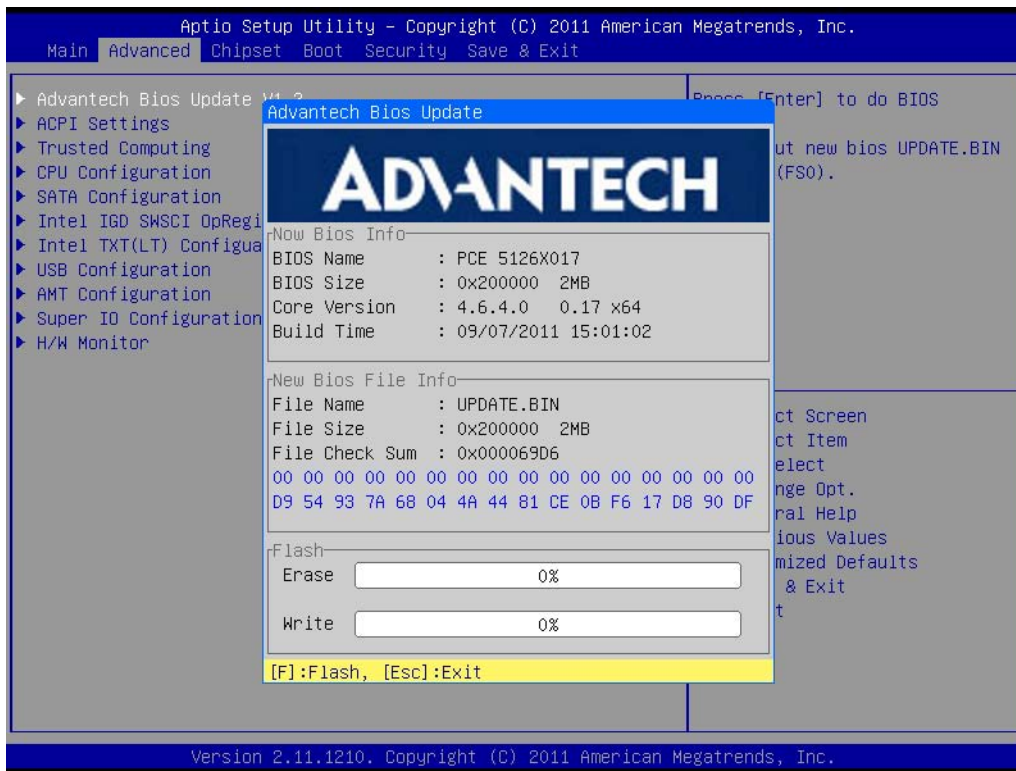

Figure 3.4 Advantech BIOS Update V1.2

You can update BIOS from UPDATE.BIN file in FAT32 storage device

3.2.2.2 ACPI Settings

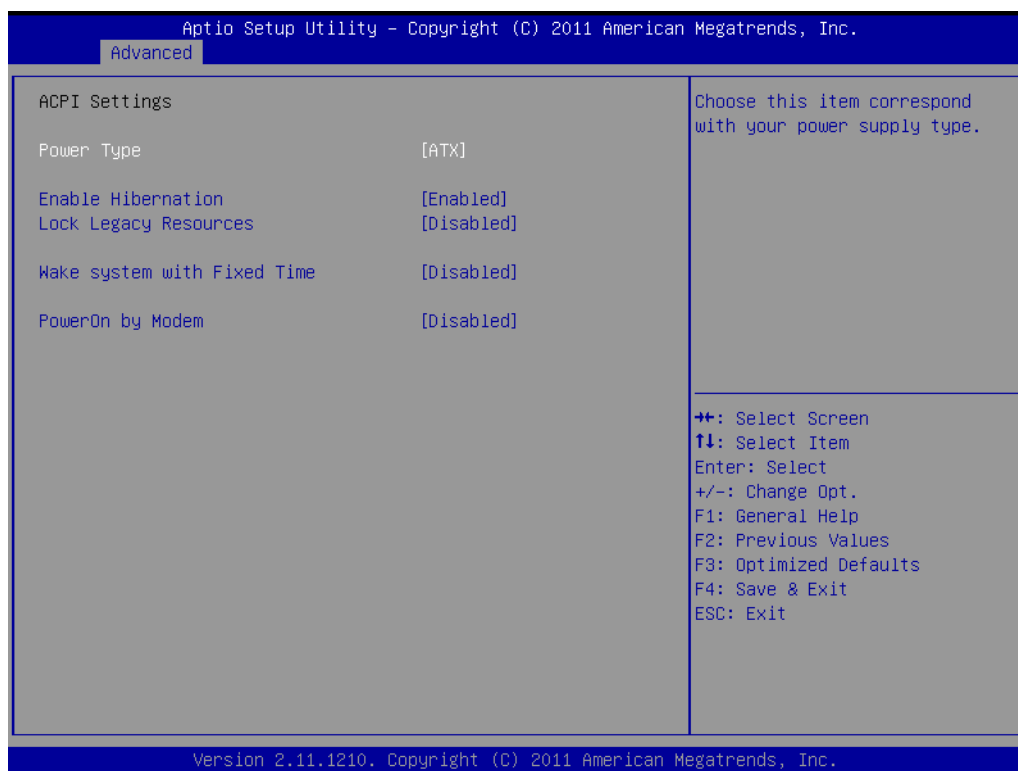

Figure 3.5 ACPI Settings

- **Power Type**
Choose this item correspond with your power supply type ATX or AT.

- **Enable Hibernation**
"Enable or disable" Hibernation (OS/S4 Sleep State). This option may not be effective with some OSs.
- **Lock Legacy Resources**
"Enabled" or "Disabled" Lock Legacy Resources.
- **Wake System with Fixed Time**
"Enabled" or "Disabled" Wake System with Fixed Time.
- **PowerOn by Modem**
"Enabled" or "Disabled" PowerOn by Modem

3.2.2.3 TPM Configuration

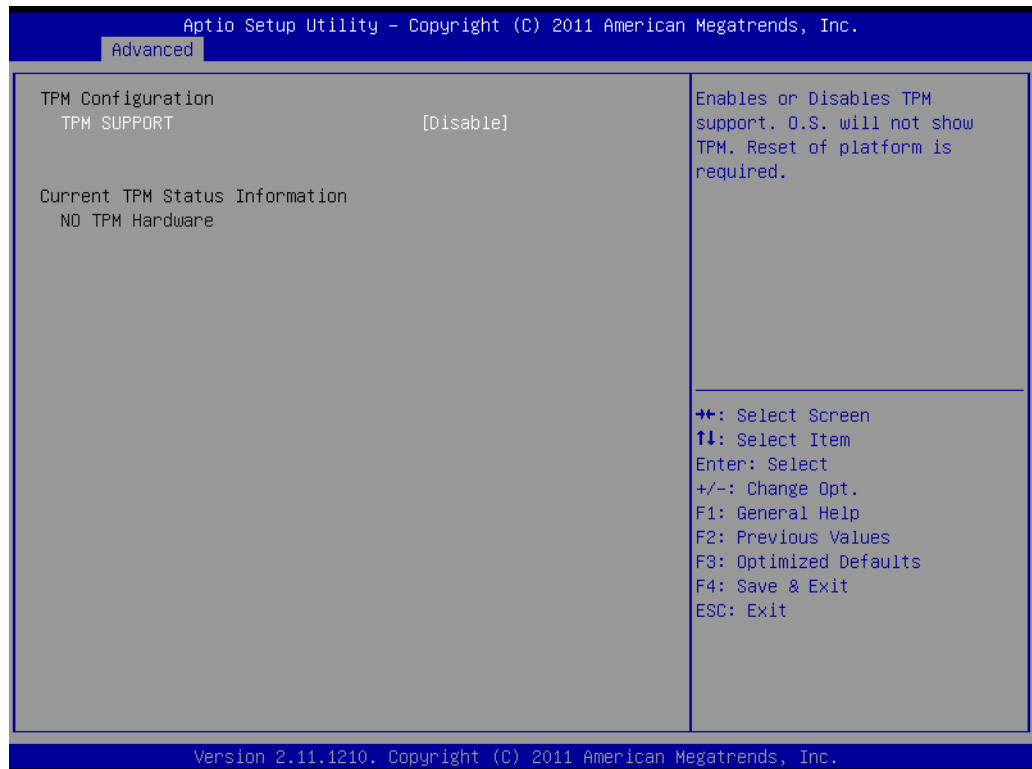

Figure 3.6 TPM Configuration

- **TPM Support**
"Enable or disable" TPM Support. You can purchase Advantech LPC TPM module to enable TPM function. P/N: PCA-TPM-00A1E

3.2.2.4 CPU Configuration

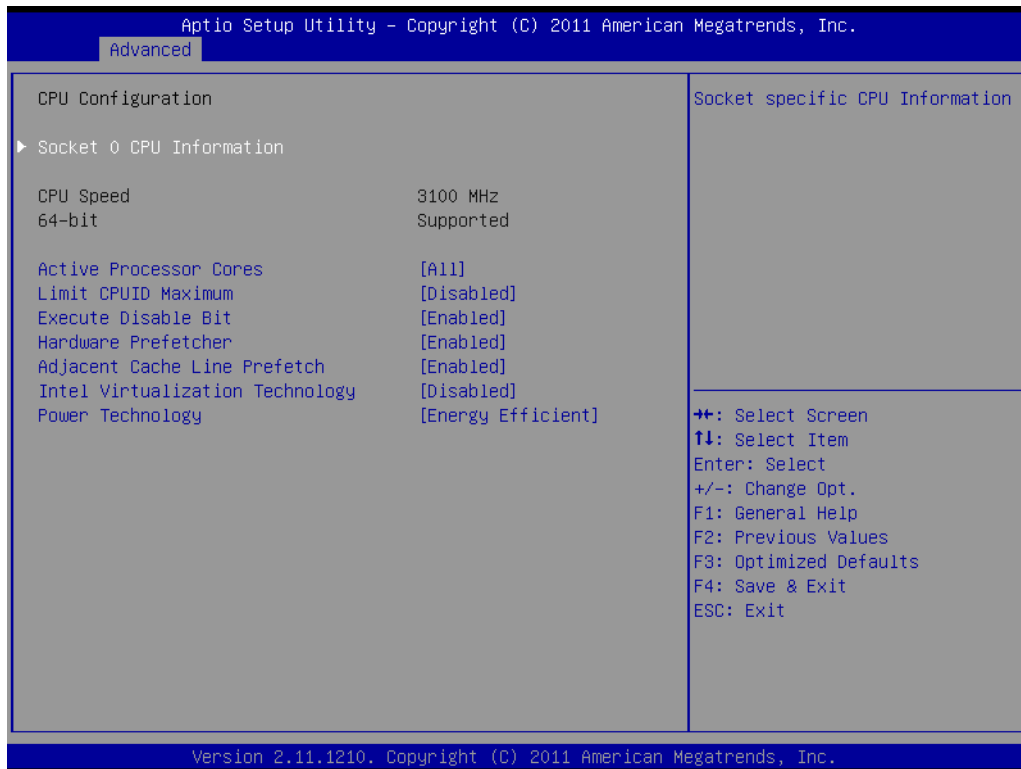

Figure 3.7 CPU Configuration

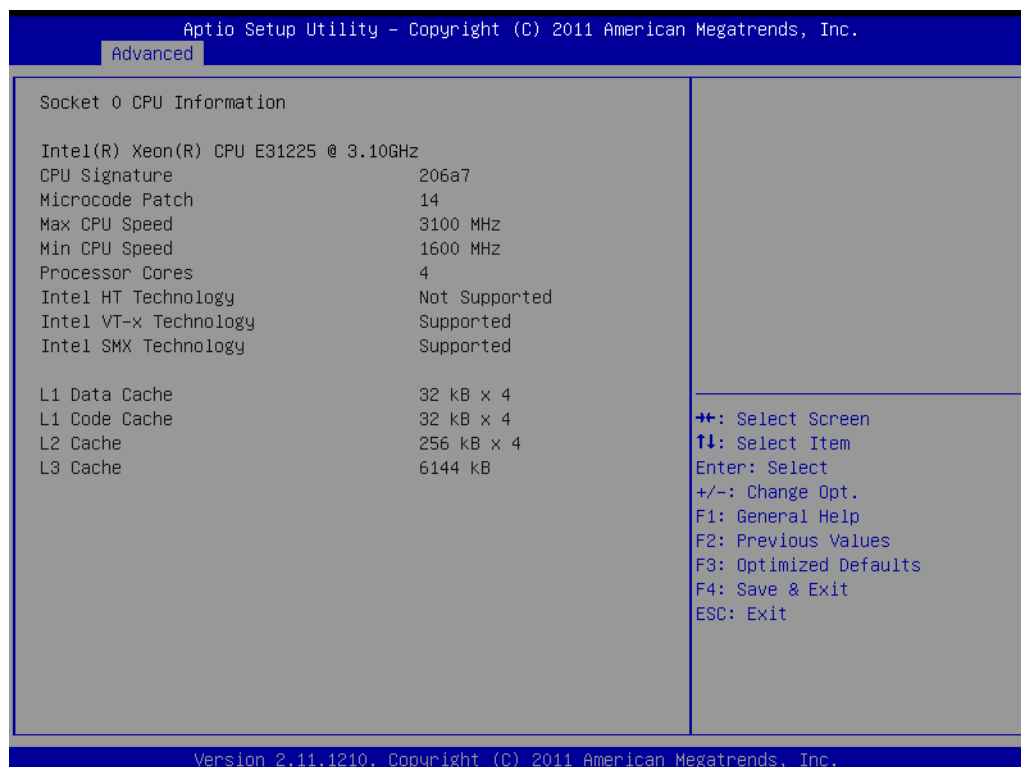

Figure 3.8 Socket 0 CPU Information

- **Active Processor Core**

Use this to select how many processor cores you want to activate when you are using a dual or quad core processor.

- **Limit CPUID Maximum**
Setting this item to [Enable] allows legacy operating systems to boot even without support for CPUs with extended CPUID functions.
- **Execute Disable Bit**
This item specifies the Execute Disable Bit Feature. The settings are Enabled and Disabled. The Optimal and Fail-Safe default setting is Enabled. If Disabled is selected, the BIOS forces the XD feature flag to always return to 0.
- **Hardware Prefetcher**
Hardware Prefetcher is a technique that fetches instructions and/or data from memory into the CPU cache memory well before the CPU needs it, so that it can improve the load-to-use latency. You may choose to enable or disable it.
- **Adjacent Cache Line Prefetch**
The Adjacent Cache-Line Prefetch mechanism, like automatic hardware prefetch, operates without programmer intervention. When enabled through the BIOS, two 64-byte cache lines are fetched into a 128-byte sector, regardless of whether the additional cache line has been requested or not. You may choose to enable or disable it.
- **Intel Virtualization Technology**
This feature is used to enable or disable the Intel Virtualization Technology (IVT) extension. It allows multiple operating systems to run simultaneously on the same system. It does this by creating virtual machines, each running its own x86 operating system.
- **Power Technology**
Default is "Energy Efficient". User can set "EIST", "Turbo Mode", "P-STATE", "C3", "C6" and "Package C State Limit" at "CUSTOM Mode"

3.2.2.5 SATA Configuration

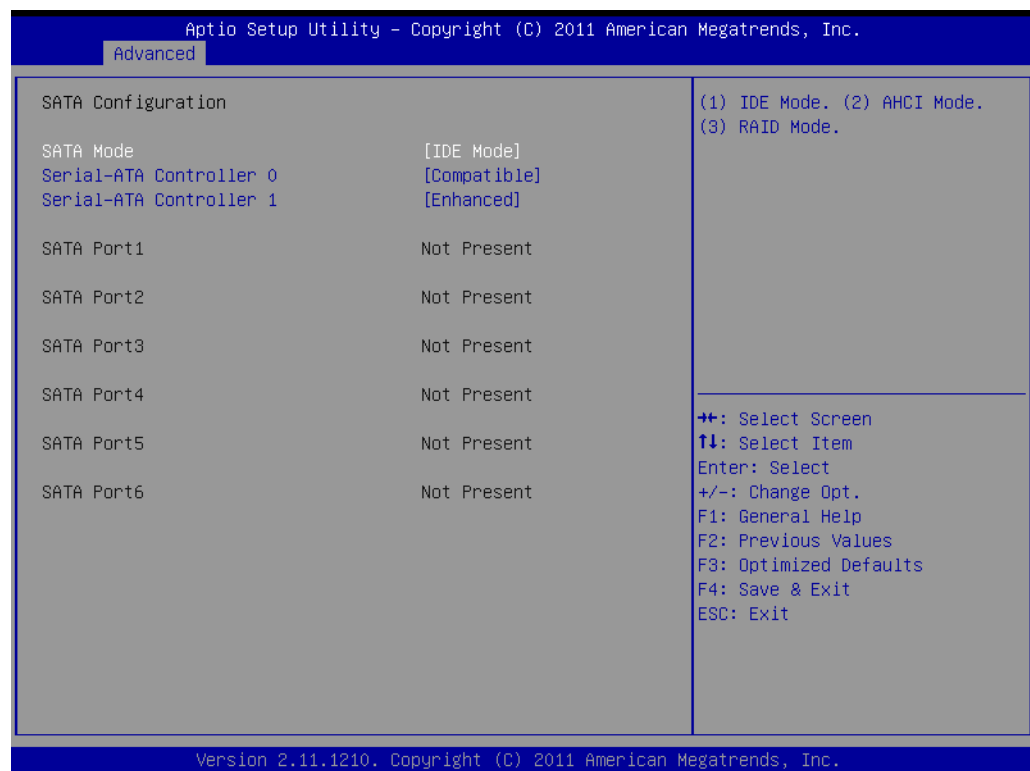

Figure 3.9 SATA Configuration

- **SATA Mode**
This can be configured as IDE, RAID, AHCI, or Disabled.

- **Serial-ATA Controller 0**

This item appears only when you set the SATA Mode item to [IDE Mode]. Set to [Enhanced] to support two SATA 6.0 Gb/s and two SATA 3.0 Gb/s devices. Set to [Compatible] when using Windows 98/NT/2000/MS-DOS. Up to four SATA devices are supported under these operating systems.

- **Serial-ATA Controller 1**

This item appears only when you set the SATA Mode item to [IDE Mode]. Set to [Enhanced] to support two SATA 3.0 Gb/s devices.

3.2.2.6 Intel IGD SWSCI OpRegion Configuration

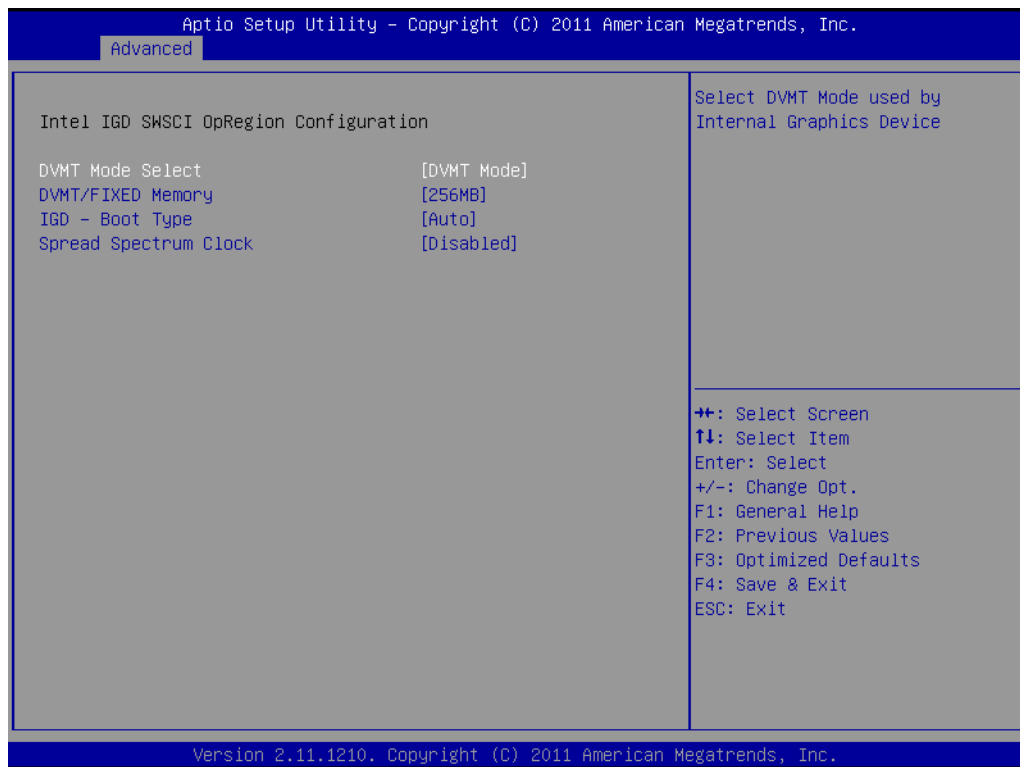

Figure 3.10 Intel IGD SWSCI OpRegion Configuration

- **DVMT/FIXED Memory**

This item allows user to set video memory. There are three options, [128MB]/[256MB]/[Maximum]

- **IGD - Boot Type**

Select the Video Device which will be activated during POST. This has no effect if external graphics present. There are three options, [Auto]/[CRT]/[DVI]. (DVI is optional).

- **Spread Spectrum Clock**

"Enable or Disable" Spread Spectrum Clock.

3.2.2.7 Intel Trusted Execution Technology Configuration

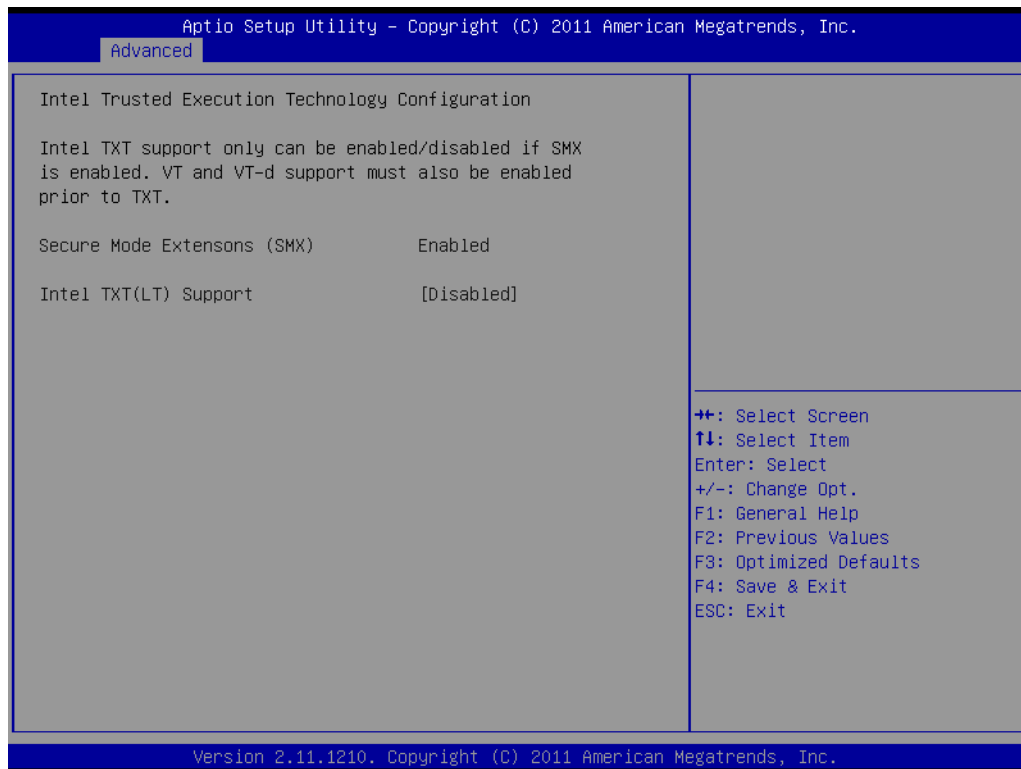

Figure 3.11 Intel Trusted Execution Technology Configuration

- **Intel Trusted Execution Technology Configuration**
This enables or disables Intel® Trusted Execution Technology

3.2.2.8 USB Configuration

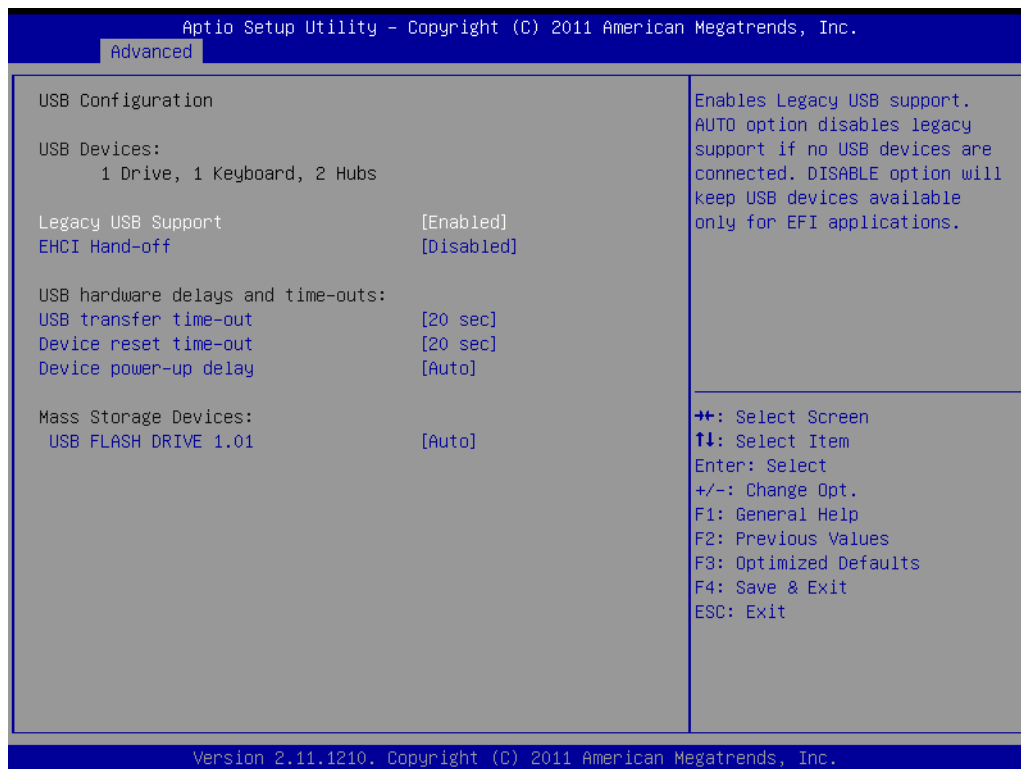

Figure 3.12 USB Configuration

- **Legacy USB Support**
This is for supporting USB device under legacy OS such as DOS. When choosing "AUTO", the system will automatically detect if any USB device is plugged into the computer and enable USB legacy mode when a USB device is plugged and disable USB legacy mode when no USB device is plugged.
 - **EHCI Hand-off**
This enables or disables supporting OS without EHCI hand-off feature.
 - **USB transfer time-out**
Allows you to select the USB transfer time-out value. [1,5,10,20sec]
 - **Device reset time-out**
Allows you to select the USB device reset time-out value. [1,5,10,20sec]
 - **Device power-up delay**
This item appears only when you set the Device power-up delay item to [manual].
 - **USB FLASH DRIVE 1.01***
This item only show when plugging a USB flash device. User can choose "Auto", "Floppy", "Forced FDD", "Hard Disk" and "CD-ROM" to simulate USB flash device.
- * This item will change wording which depends on what USB storage device you plug.

3.2.2.9 AMT Configuration

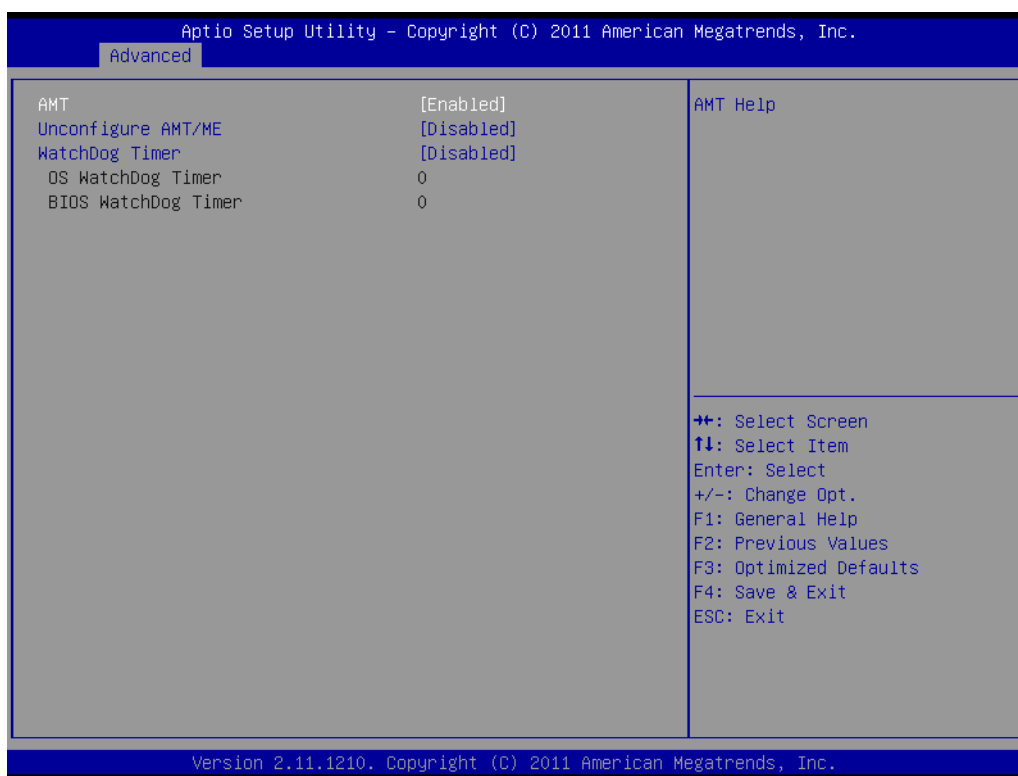

Figure 3.13 AMT Configuration

- **AMT**
"Enable or Disable" Intel Advance Management Technology
- **Unconfigure AMT/ME**
"Enable or Disable" Unconfigure AMT/ME
- **WatchDog Timer**
"Enable or Disable" Watchdog Timer

3.2.2.10 Super IO Configuration

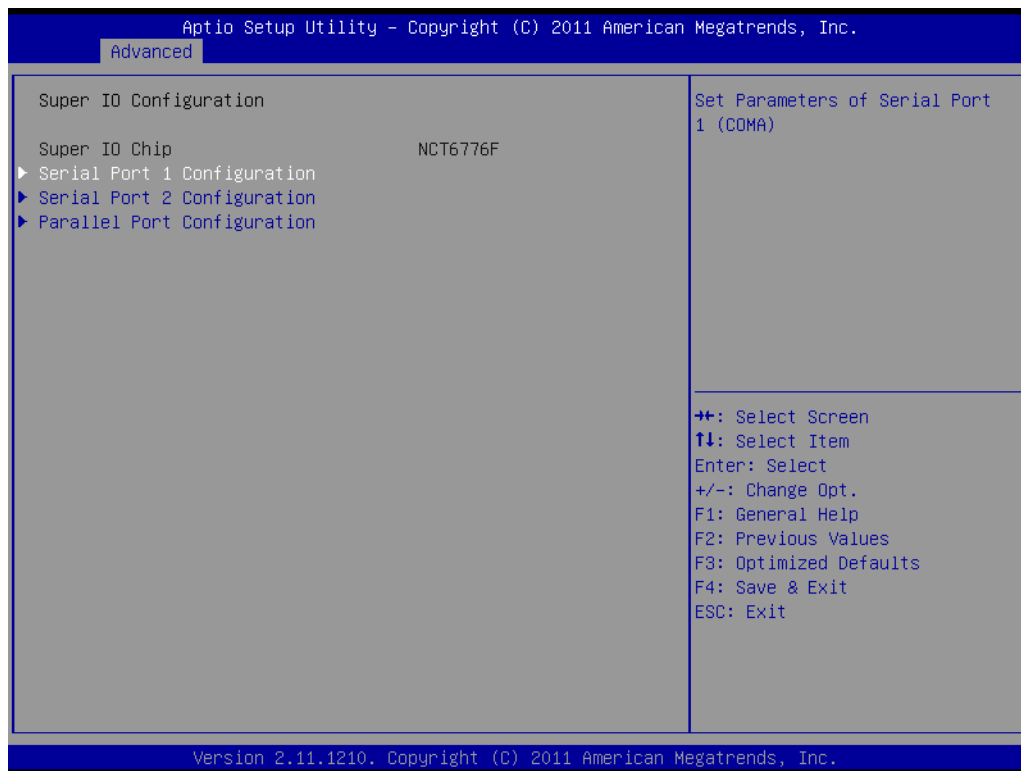

Figure 3.14 Super IO Configuration



Figure 3.15 Serial Port 1 Configuration

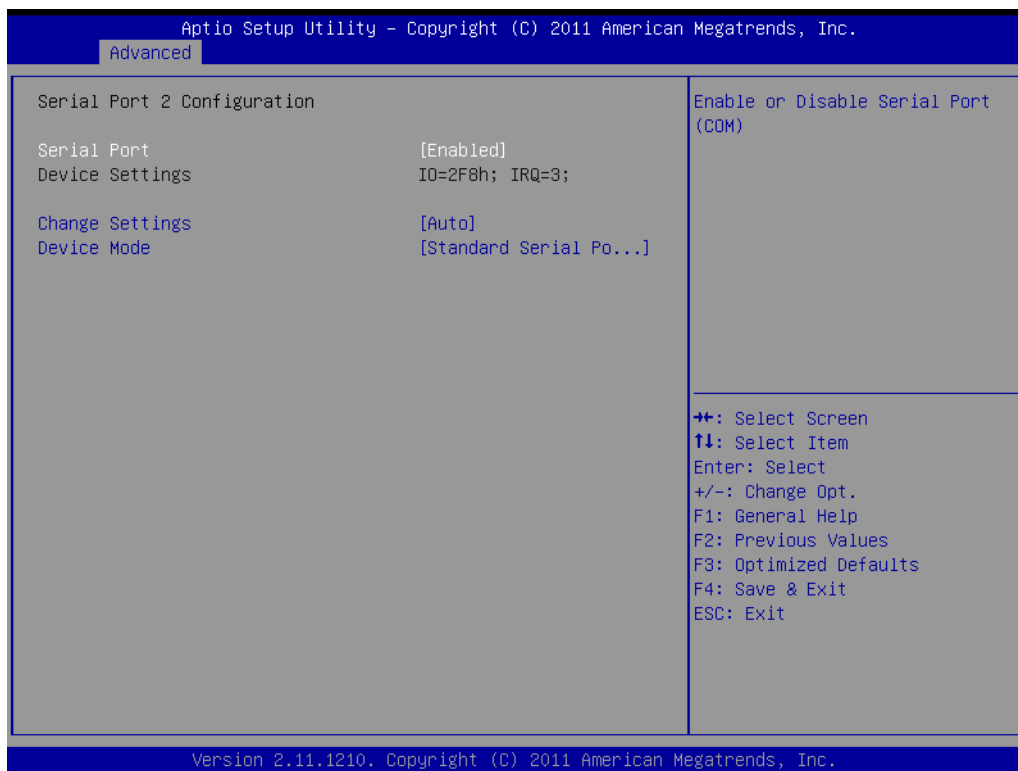

Figure 3.16 Serial Port 2 Configuration

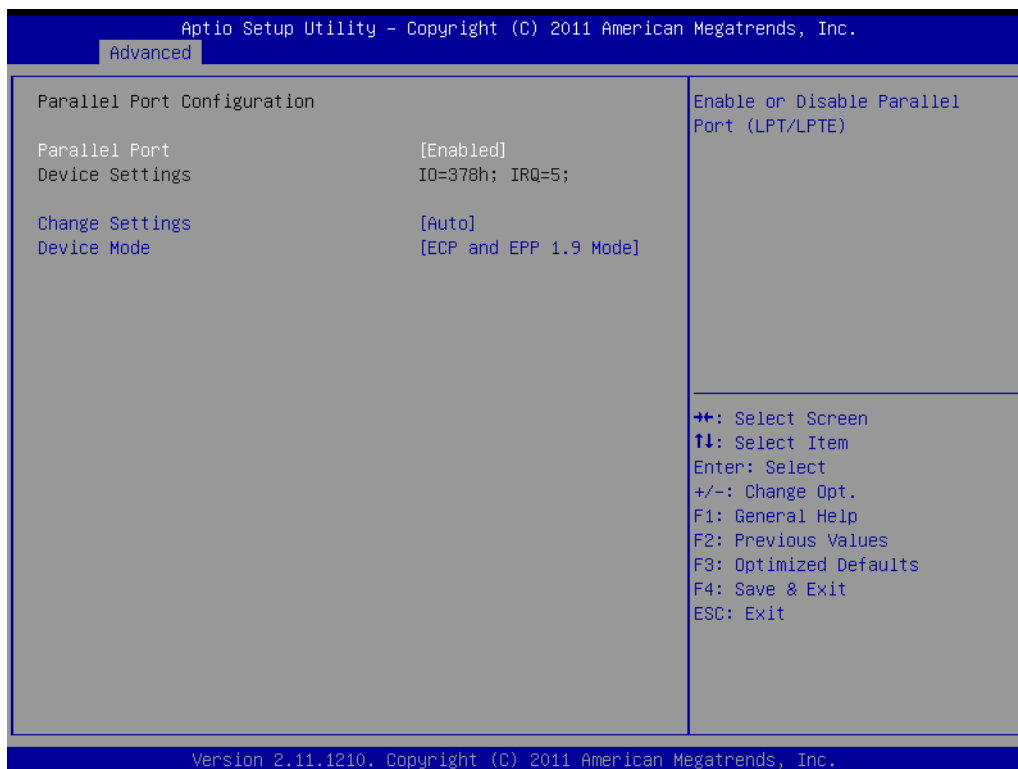

Figure 3.17 Parallel Configuration

- **Serial Port**
"Enable or Disable" Serial Port
- **Parallel Port**
"Enable or Disable" Parallel Port

3.2.2.11 PC Health Status

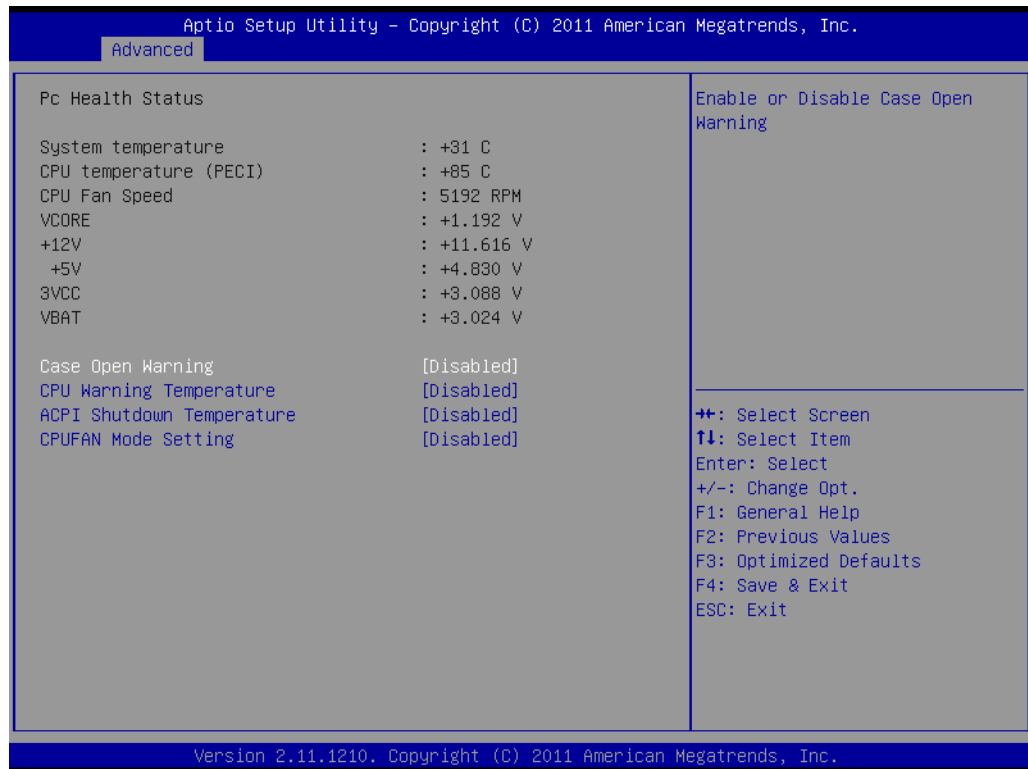

Figure 3.18 PC Health Status

- **Case Open Warning**
Enable/Disable the Chassis Intrusion monitoring function. When enabled and the case is opened, the speaker beeps.
- **CPU Warning Temperature**
Use this to set the CPU warning temperature threshold. When the system reaches the warning temperature, the speaker will beep.
- **ACPI Shutdown Temperature**
Use this to set the ACPI shutdown temperature threshold. When the system reaches the shutdown temperature, it will be automatically shut down by ACPI OS to protect the system from overheating damage.
- **CPUFAN Mode Setting**
"Enable or Disable" CPUFAN Mode to SMART FAN setting

3.2.3 Chipset

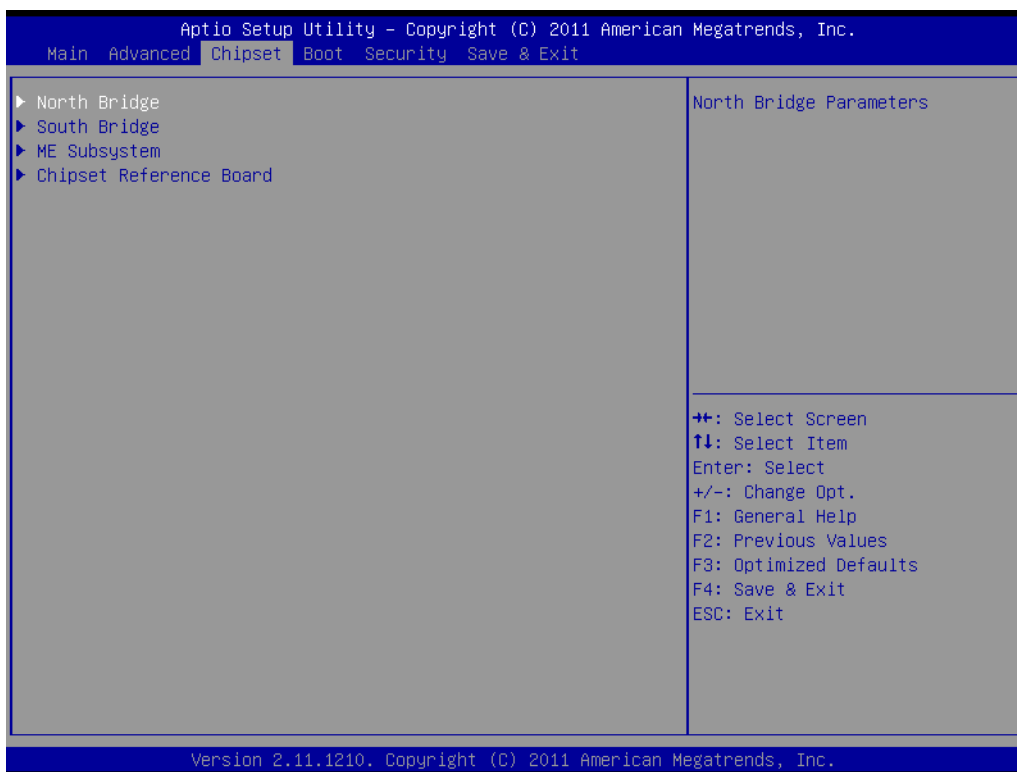

Figure 3.19 Chipset

3.2.3.1 North Bridge

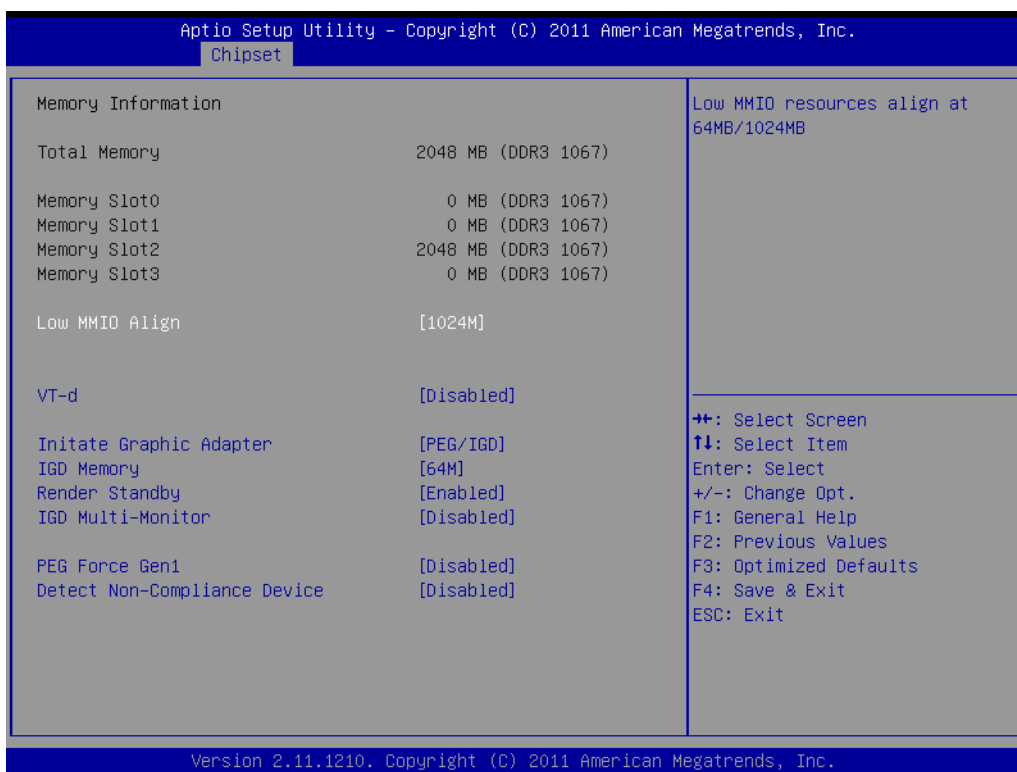

Figure 3.20 North Bridge

- **Low MMIO Align**
Low MMIO resources align at 64MB/1024MB.

- **VT-d**
To support Intel chipset virtualization technology for directed I/O.
- **Initiate Graphic Adapter**
This setting allows users to select which graphics controller to be the primary graphic device when booting up.
- **IGD Memory**
Allows users to select integrated graphic memory.
- **Render Standby**
"Enable, Disable" Render Standby by Internal Graphics Device
- **IGD Multi-Monitor**
"Enable, Disable" IGD Multi-monitor by Internal Graphics Internal Device
- **PEG Force Gen1**
Allows users to force PEG port downgrade to Gen1.
- **Detect Non-Compliance Device**
"Enable, Disable" Detect Non-Compliance Device

3.2.3.2 South Bridge

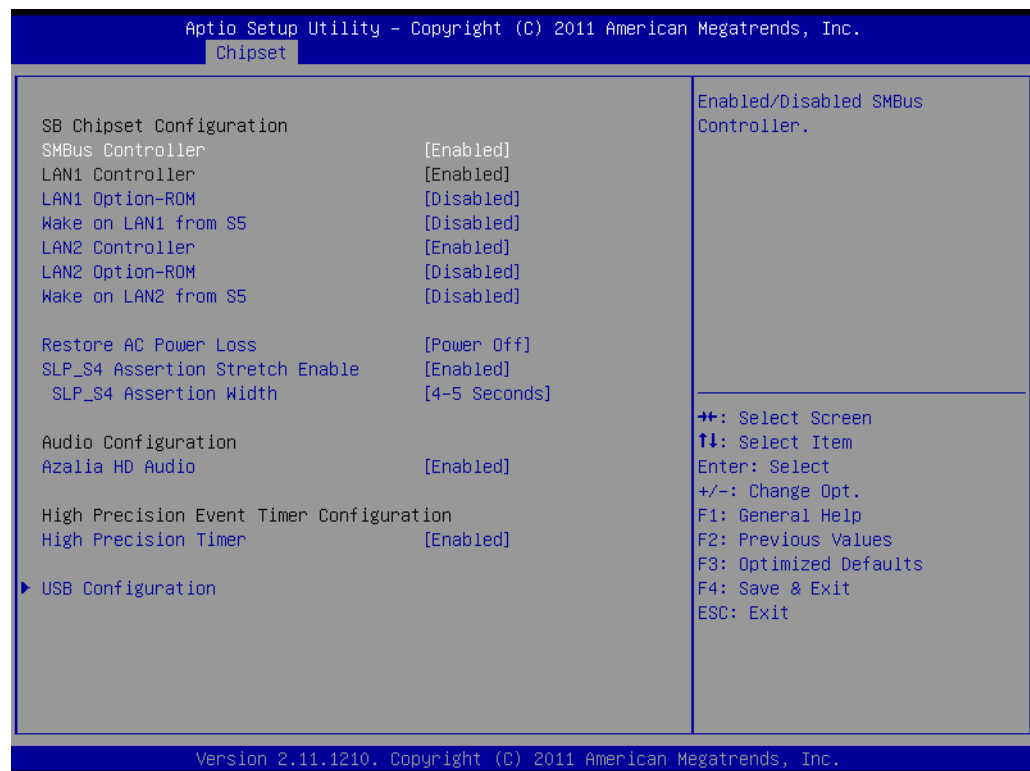



Figure 3.21 South Bridge

- **SMBus Controller**
"Enable or Disable" SMBus Controller.
- **LAN2 Controller**
"Enable or Disable" LAN2 Controller.
- **LAN Option-ROM**
"Enable or Disable" LAN Option-ROM.
- **Wake on LAN from S5**
"Enable or Disable" Wake on LAN from S5.

- **Restore AC Power Loss**
"Power Off, power On or Last State" to restore AC power loss
- **SLP_S4 Assertion Stretch Enable**
"Enable" to select a minimum assertion width of the SLP_S4 signal
- **SLP_S4 Assertion Width**
"1-2,2-3,3-4,4-5" SLP_S4 assertion width help
- **Azalia HD Audio**
"Enable or Disable" HD Audio for optional PCA-AUDIO-HDA1E
- **High Precision Timer**
"Enable or Disable" High Precision Event Timer
- **Deep S5**
"Enable for Disable" Deep S5 feature. When Deep D5 is enabled, most power, including 5 VASB, will be off during Deep S5 for energy savings.

Note!  When a system enters G3 status with Deep S5 enabled, some power supply's 5 VSB won't drop until after more than 30 seconds. If "Restore AC Power Loss" is set to "power on", the system won't boot up in 30 seconds after power failure. We recommend the users wait for more than 30 seconds to power on after a power failure. The system will auto power on if power is restored within 30 seconds, before 5 VSB actually drops, even if "Restore AC Power Loss" is set to "power off".

3.2.3.3 USB Configuration

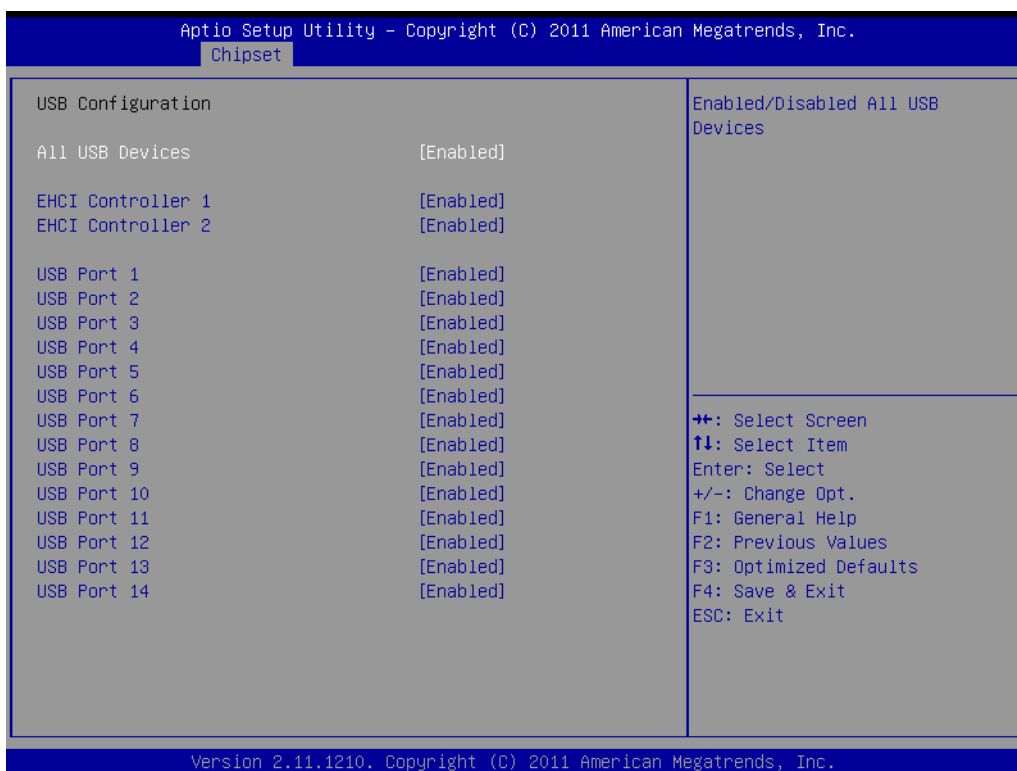

Figure 3.22 USB Configuration

- **All USB Devices**
"Enable or Disable" All USB Devices.
- **EHCI Controller #1 & #2**
"Enable or Disable" EHCI Controller #1 or #2.

- **USB Port 1~14**
"Enable or Disable" USB Port 1~14.

3.2.3.4 ME Subsystem

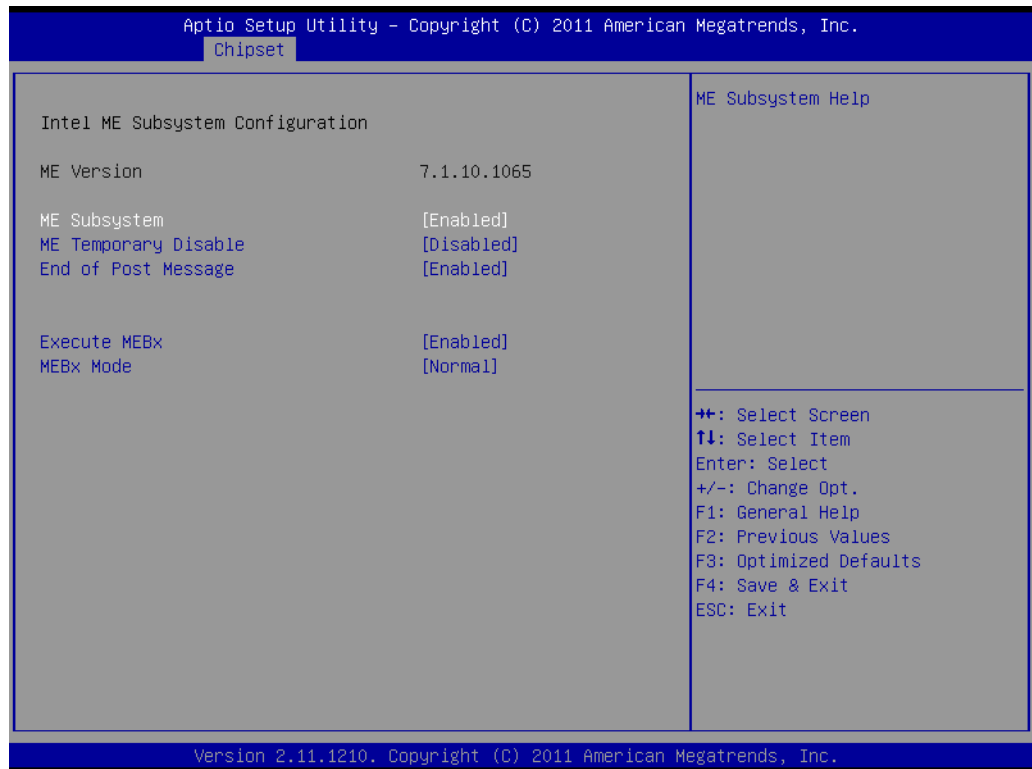

Figure 3.23 ME Subsystem

- **ME Subsystem**
"Enable or Disable" Intel Management Engine Subsystem.
- **ME Temporary Disable**
"Enable or Disable" ME Temporary Disable
- **End of Post Message**
"Enable or Disable" End of Post Message.
- **Execute MEBx**
"Enable or Disable" Execute MEBx to show "Ctrl+P" to enter ME setup during post screen
- **MEBx Mode**
"Normal, Hidden Ctrl+P, Enter MEBx Setup" to use ME setup

3.2.3.5 Chipset Reference Board

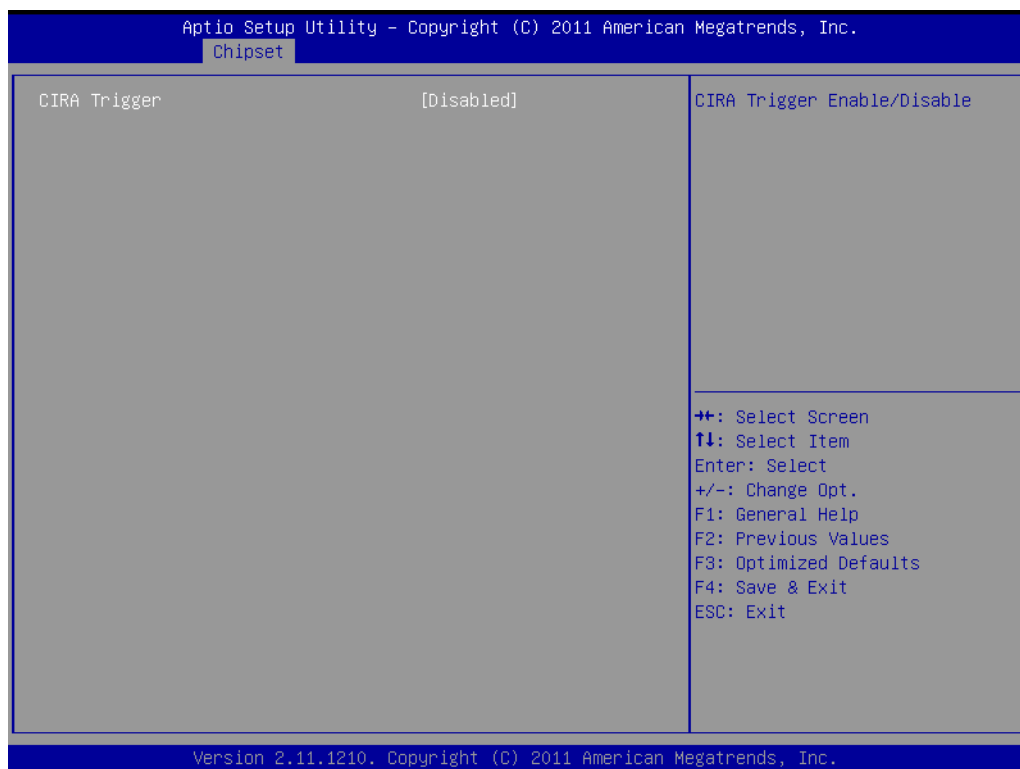

Figure 3.24 Chipset Reference Board

- **CIRA Trigger**
"Enable or Disable" CIRA Trigger.

3.2.4 Boot

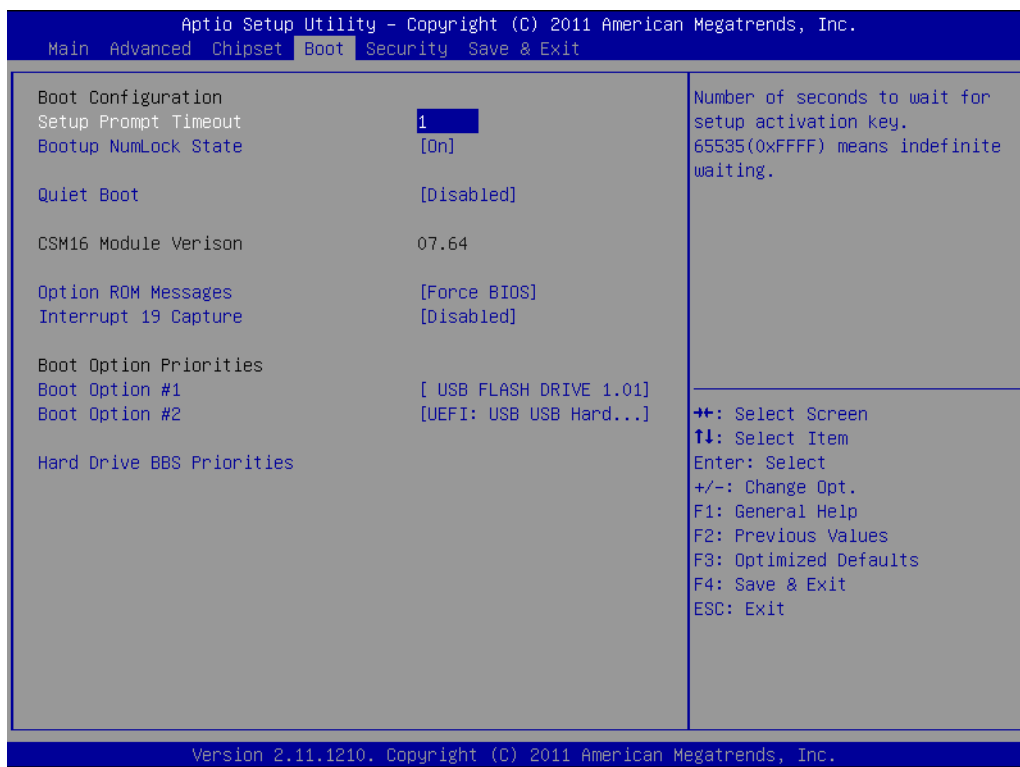

Figure 3.25 Boot

- **Setup Prompt Timeout**
Use the <+> and <-> keys to adjust the number of seconds to wait for setup activation key.
- **Bootup NumLock State**
"On or Off" power-on state for the NumLock
- **Quiet Boot**
If this option is set to Disabled, the BIOS displays normal POST messages. If Enabled, an OEM Logo is shown instead of POST messages.
- **Option ROM Messages**
"Force BIOS or Keep Current" to set the display mode for Option ROM
- **Interrupt 19 Capture**
"Enable or Disable" Option ROM to trap Interrupt 19
- **Boot Option**
Choose boot priority from boot device

3.2.5 Security

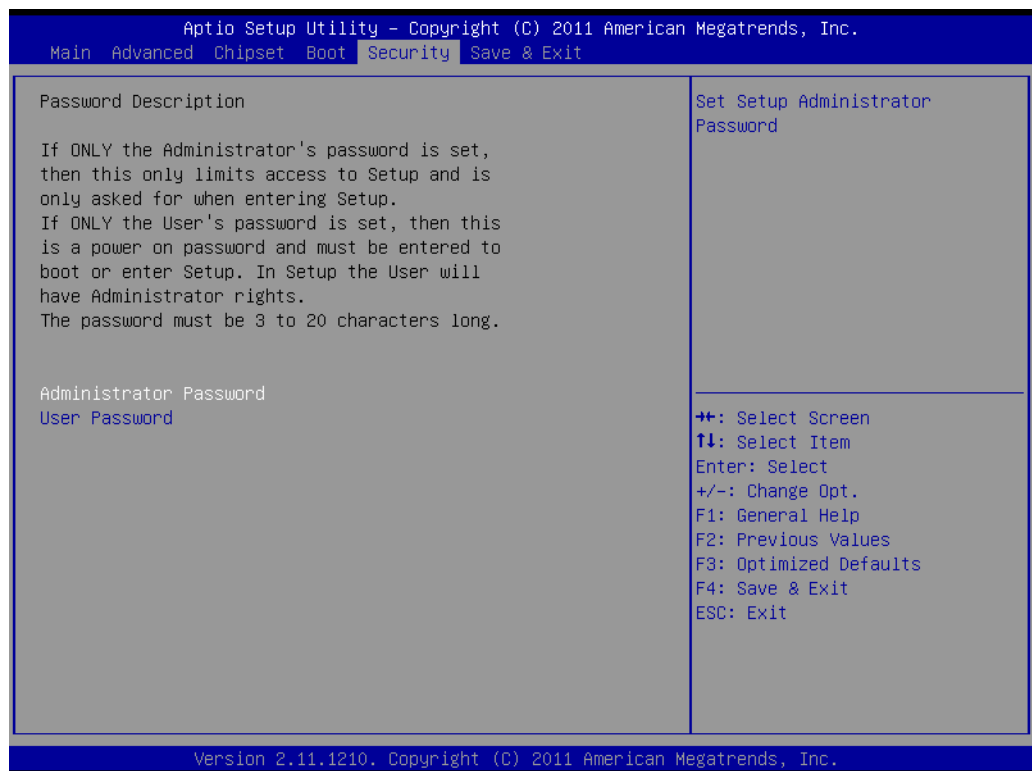

Figure 3.26 Security

Select Security Setup from the PCE-5126 Setup main BIOS setup menu. All Security Setup options, such as password protection and virus protection are described in this section. To access the sub menu for the following items, select the item and press <Enter>

3.2.6 Save & Exit

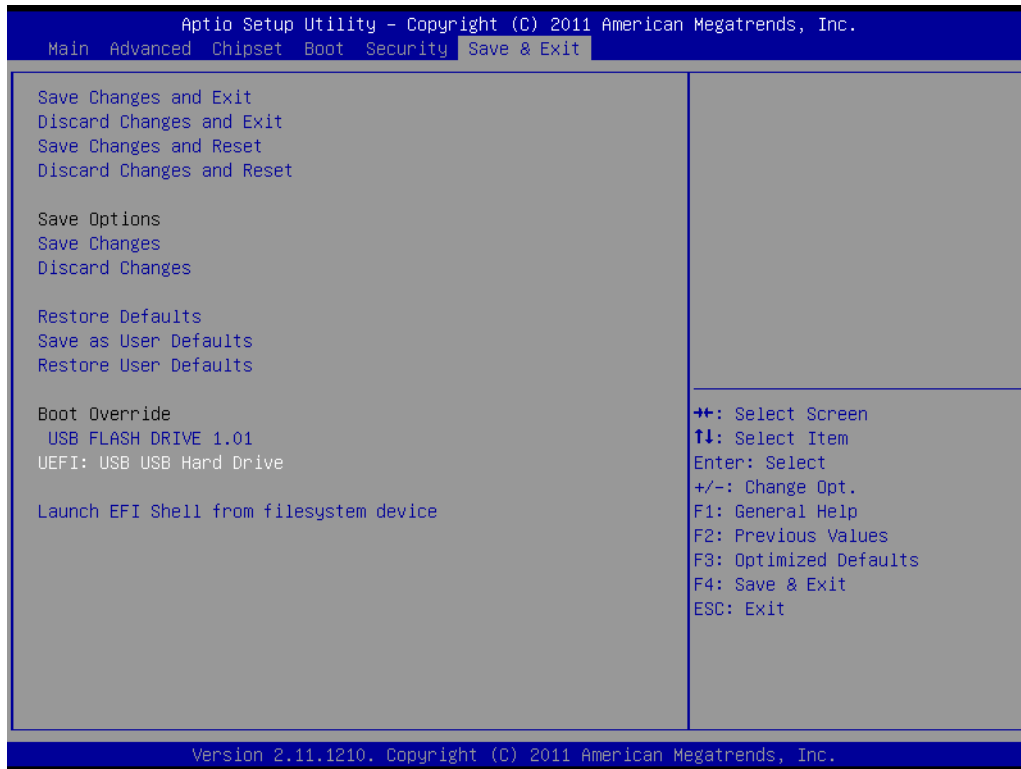

Figure 3.27 Save & Exit

Save changes and exit*

When you have completed system configuration, select this option to save your changes, exit BIOS setup and boot into the OS so the new system configuration parameters can take effect.

Discard changes and exit

Select this option to quit Setup without making any permanent changes to the system configuration.

Save changes and Reset

When you have completed system configuration, select this option to save your changes, exit BIOS setup and reboot into the computer so the new system configuration parameters can take effect.

Discard changes and Reset

Select this option to quit Setup and reset computer without making any permanent changes to the system configuration.

Save Changes

Select this option to save your changes.

Discard Changes

Select this option to discard your changes.

Restore Defaults

Select this option to restore BIOS configuration as origin.

Save as User Defaults

Select this option to save user's configuration.

Restore User Defaults

Select this option to restore BIOS to user's configuration.

Launch EFI Shell from file system device

This option allows you to attempt to launch the EFI Shell application (shellx64.efi) from one of the available file system devices.

*When you do some critical changes, the system will still reboot even you choose "Save changes and exit".

Chapter 4

Value-Added Software Services

4.1 Value-Added Software Services

Software API: An interface that defines the ways in which an application program may request services from libraries and/or operating systems. Provides not only the underlying drivers required but also a rich set of user-friendly, intelligent and integrated interfaces, which speeds development, enhances security and offers add-on value for Advantech platforms. It plays the role of catalyst between developer and solution, and makes Advantech embedded platforms easier and simpler to adopt and operate with customer applications. The API and utility is only for XP, and if user needs Linux version API and utility, please contact with Advantech representative for support it.

4.1.1 Software API

4.1.1.1 Control

GPIO



General Purpose Input/Output is a flexible parallel interface that allows a variety of custom connections. allows users to monitor the level of signal input or set the output status to switch on/off the device. Our API also provides Programmable GPIO, which allows developers to dynamically set the GPIO input or output status.

4.1.1.2 Monitor

Watchdog



A watchdog timer (WDT) is a device that performs a specific operation after a certain period of time if something goes wrong and the system does not recover on its own. A watchdog timer can be programmed to perform a warm boot (restarting the system) after a certain number of seconds.

Hardware Monitor



The Hardware Monitor (HWM) API is a system health supervision API that inspects certain condition indexes, such as fan speed, temperature and voltage.

4.1.2 Software Utility

Embedded Security ID



The embedded application is the most important property of a system integrator. It contains valuable intellectual property, design knowledge and innovation, but it is easily copied! The Embedded Security ID utility provides reliable security functions for customers to secure their application data within the embedded BIOS.

Monitoring



The Monitoring utility allows the customer to monitor system health, including voltage, CPU and system temperature and fan speed. These items are important to a device; if critical errors happen and are not solved immediately, permanent damage may be caused.

eSOS



The eSOS is a small OS stored in BIOS ROM. It will boot up in case of a main OS crash. It will diagnose the hardware status, and then send an e-mail to a designated administrator. The eSOS also provides remote connection: Telnet server and FTP server, allowing the administrator to rescue the system.

Note: This function requires BIOS customization.

Chapter 5

Chipset Software
Installation Utility

5.1 Before You Begin

To facilitate the installation of the enhanced display drivers and utility software, read the instructions in this chapter carefully. The drivers for the PCE-5126 are located on the software installation CD. The driver in the folder of the driver CD will guide and link you to the utilities and drivers under a Windows system. Updates are provided via Service Packs from Microsoft®.

Note! *The files on the software installation CD are compressed. Do not attempt to install the drivers by copying the files manually. You must use the supplied SETUP program to install the drivers.*



Before you begin, it is important to note that most display drivers need to have the relevant software application already installed in the system prior to installing the enhanced display drivers. In addition, many of the installation procedures assume that you are familiar with both the relevant software applications and operating system commands. Review the relevant operating system commands and the pertinent sections of your application software's user manual before performing the installation.

5.2 Introduction

The Intel® Chipset Software Installation (CSI) utility installs the Windows INF files that outline to the operating system how the chipset components will be configured. This is needed for the proper functioning of the following features:

- Core PCI PnP services
- Serial ATA interface support
- USB 1.1/2.0 support
- Identification of Intel® chipset components in the Device Manager
- Integrates superior video features. These include filtered sealing of 720 pixel DVD content, and MPEG-2 motion compensation for software DVD

5.3 Windows® XP / Windows® 7 Driver Setup

1. Insert the driver CD into your system's CD-ROM drive. You can see the driver folder items. Navigate to the "01-Chipset" folder and click "infnst_autol.exe" to complete the installation of the driver.

Note! *Wrong driver installation may cause unexpected system instability.*



The drivers on this CD support both Windows XP 32-bit /64-bit and Windows 7 32-bit/64-bit.

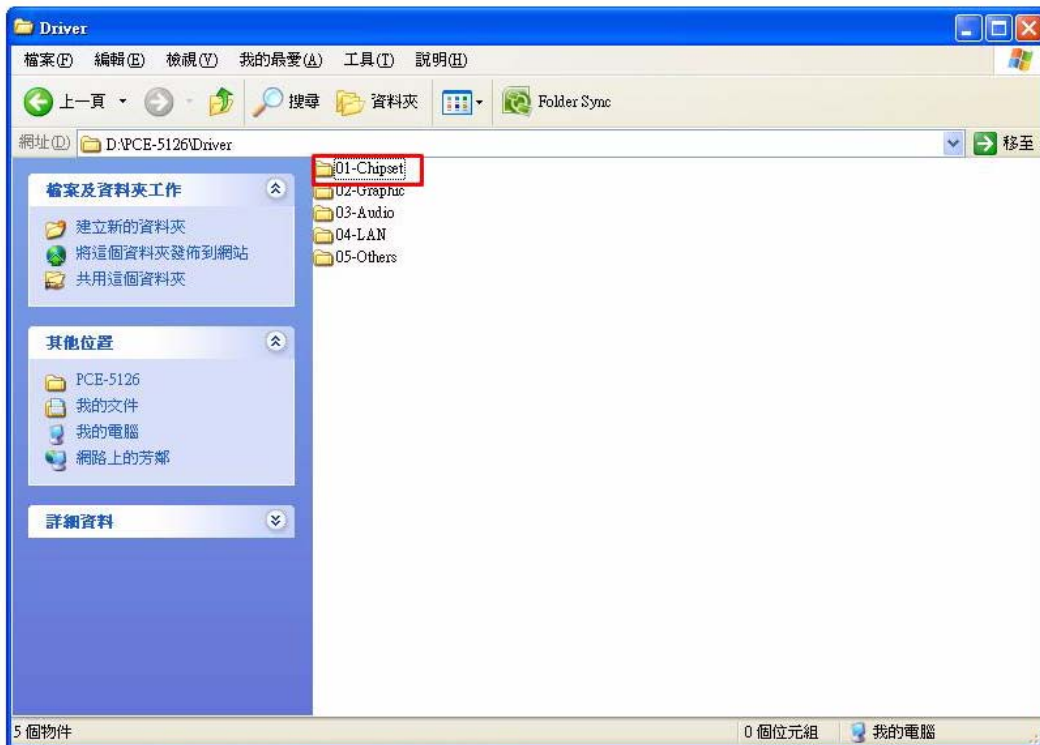

Chapter 6

Integrated Graphic
Device Setup

6.1 Introduction

The Intel® LGA1155 CPUs have integrated graphics controllers. You need to install the VGA driver to enable this function, which includes the following features:

- **Optimized integrated graphic solution:** Intel Graphics Flexible Display Interface supports versatile display options and 32-bit 3D graphics engine. Dual independent display, enhanced display modes for widescreen flat panels for extend, twin, and clone dual display mode, and optimized 3D support deliver an intensive and realistic visual experience.

6.2 Windows XP/Windows 7 Driver Setup

Note! Before installing this driver, make sure the INF driver has been installed in your system. See Chapter 5 for information on installing the INF driver.



Insert the driver CD into your system's CD-ROM drive. You can see the driver folder items. Navigate to the "VGA" folder and click "setup.exe" to complete the installation of the driver.

Note! Wrong driver installation may cause unexpected system instability.

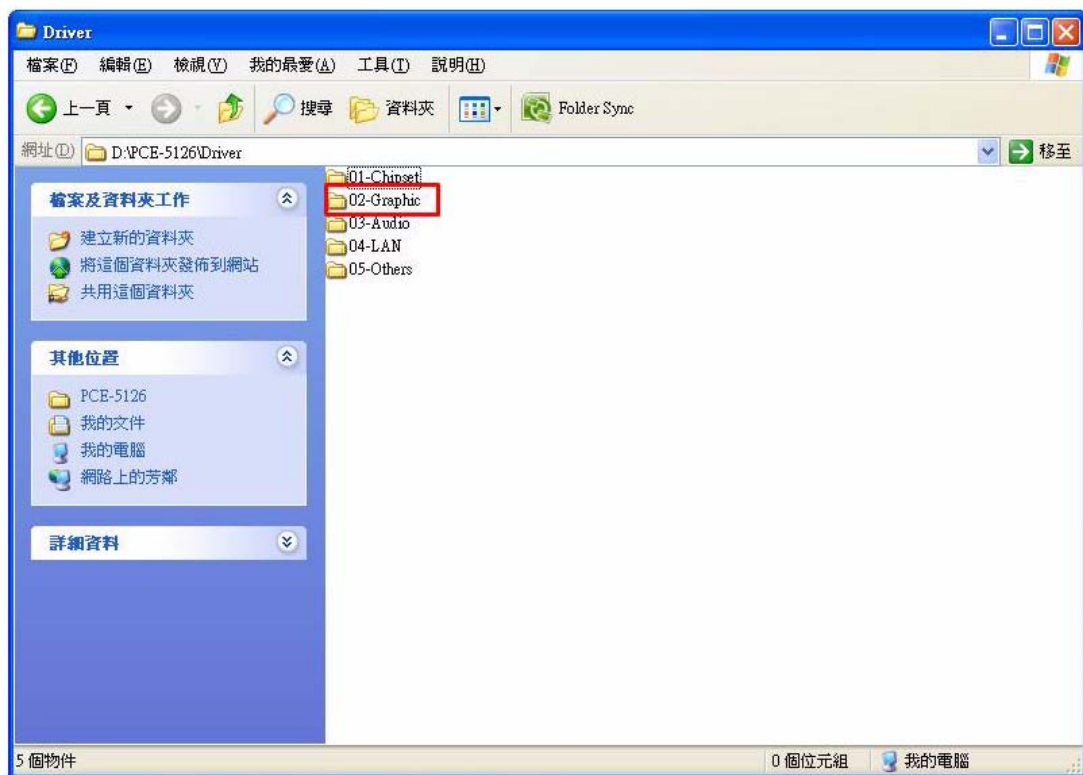

Chapter 7

LAN Configuration

7.1 Introduction

The PCE-5126 has dual Gigabit Ethernet LANs via dedicated PCI Express x1 lanes (Intel 82579LM (LAN1) and 82583V (LAN2 of QG2) or 82574L (LAN2 of WG2) that offer bandwidth of up to 500 MB/sec, eliminating the bottleneck of network data flow and incorporating Gigabit Ethernet at 1000 Mbps.

7.2 Installation

Note! Before installing the LAN drivers, make sure the CSI utility has been installed on your system. See Chapter 5 for information on installing the CSI utility.



The PCE-5126's Intel 82579LM (LAN1) and 82583V/82574L (LAN2) Gigabit integrated controllers support all major network operating systems. However, the installation procedure varies from system to system. Please find and use the section that provides the driver setup procedure for the operating system you are using.

7.3 Win XP /Win 7 Driver Setup (LAN)

Insert the driver CD into your system's CD-ROM drive. Navigate to the "04-LAN" folder and click "setup.exe" to complete the installation of the driver.

Note! Wrong driver installation may cause unexpected system instability.

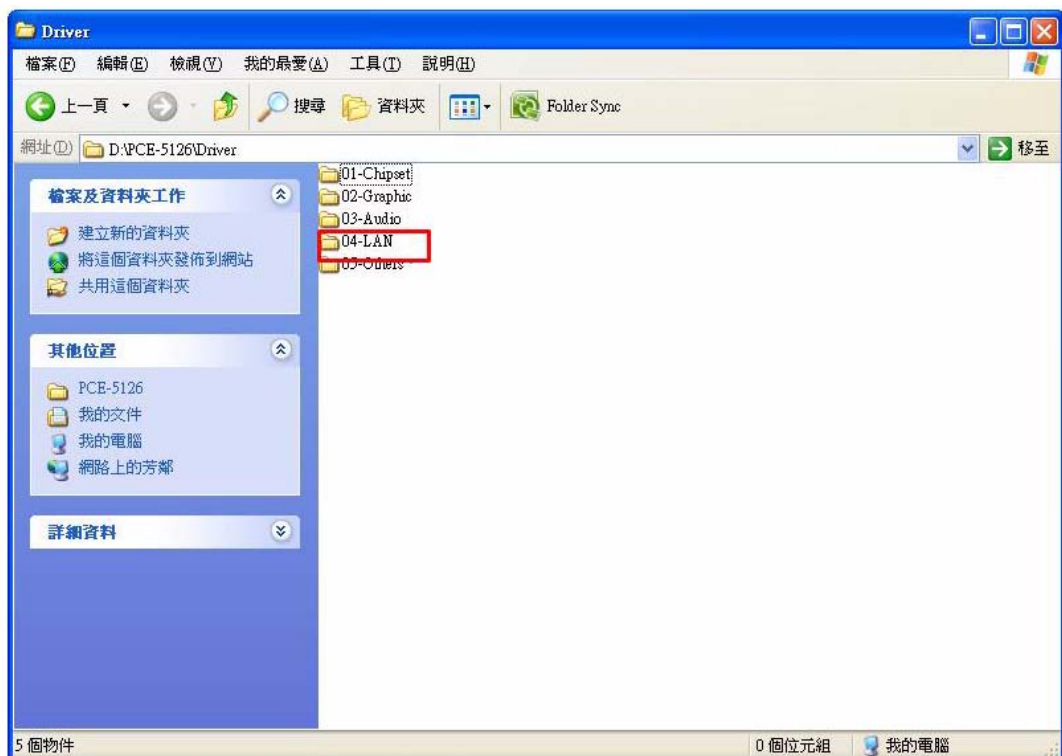

Chapter 8

SATA RAID Setup

8.1 Introduction

To support demanding disk I/O, Intel Q67/C206 chipset integrates six Serial ATA controllers with software RAID 0, 1, 5, 10 capabilities.

RAID 0 striping increases the storage performance and is designed to speed up data transfer rates for disk-intensive applications.

RAID 1 mirroring protects valuable data that might be lost in the event of a hard drive failure.

RAID 5 array contains three or more hard drives where the data is divided into manageable blocks called strips. Parity is a mathematical method for recreating data that was lost from a single drive, which increases fault-tolerance. The data and parity are striped across all the hard drives in the array. The parity is striped in a rotating sequence to reduce bottlenecks associated with the parity calculations.

RAID 10 array uses four hard drives to create a combination of RAID levels 0 and 1. The data is striped across a two-drive array forming the RAID 0 component. Each of the drives in the RAID 0 array is then mirrored by a RAID 1 component.

8.2 SATA RAID Driver and Utility Setup

Note!  For the detailed installation instructions for the SATA RAID driver and utility, please check the User Guide in the driver CD. Path: Others\RAID

Note!  Before you install the Intel® Matrix Storage Manager, please read the "readme.txt" which is in the folder "Others\RAID".

The driver is in the CD's "Others\RAID" folder. You may go to the directory of the CD and follow Intel's installation guide to install the driver and utility.

Appendix **A**

Programming the Watchdog Timer

A.1 Introduction

The PCE-5126's watchdog timer can be used to monitor system software operation and take corrective action if the software fails to function within the programmed period. This section describes the operation of the watchdog timer and how to program it.

A.1.1 Watchdog timer overview

The watchdog timer is built in to the NCT6776F super I/O controller. It provides the following user programmable functions:

- Can be enabled and disabled by user's program
- Timer can be set from 1 to 255 seconds or 1 to 255 minutes
- Generates reset signal if the software fails to reset the timer before time-out

A.1.2 Programming the watchdog timer

The I/O port address of the watchdog timer is 2E (hex) and 2F (hex). 2E (hex) is the address port. 2F (hex) is the data port. You must first write an address value into address port 2E (hex), then write/read data to/from the assigned register through data port 2F (hex).

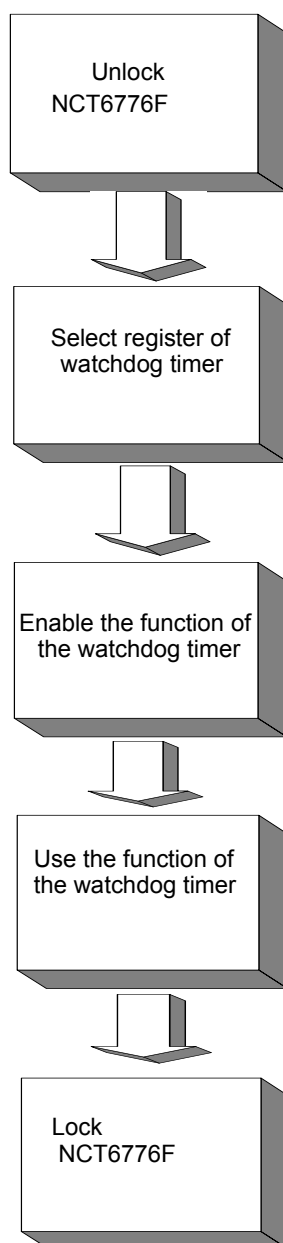
Table A.1: Watchdog timer registers

Address of register (2E)	Attribute Read/Write	Value (2F) & description
87 (hex)	----	Write this address to I/O address port 2E (hex) twice to unlock the NCT6776F
07 (hex)	write	Write 08 (hex) to select register of watchdog timer.
30 (hex)	write	Write 01 (hex) to enable the function of the watchdog timer. Disabled is set as default.
F5 (hex)	write	Set seconds or minutes as units for the timer. Write 0 to bit 3: set second as counting unit. [default]. Write 1 to bit 3: set minutes as counting unit Write 1 to bit 4: Watchdog timer count mode is 1000 times faster. If bit 3 is 0, the count mode is 1/1000 seconds mode. If bit 3 is 1, the count mode is 1/1000 minutes mode.

F6 (hex)	write	0: stop timer [default] 01~FF (hex): The amount of the count, in seconds or minutes, depends on the value set in register F5 (hex). This number decides how long the watchdog timer waits for strobe before generating an interrupt or reset signal. Writing a new value to this register can reset the timer to count with the new value.
F7 (hex)	read/write	Bit 6: Write 1 to enable keyboard to reset the timer, 0 to disable.[default] Bit 5: Write 1 to generate a timeout signal immediately and automatically return to 0. [default=0] Bit 4: Read status of watchdog timer, 1 means timer is "timeout".
AA (hex)	----	Write this address to I/O port 2E (hex) to lock the NCT6676F.

A.1.3 Example program

1. Enable watchdog timer and set 10 sec. as timeout interval

```

;-----
Mov dx,2eh          ; Unlock NCT6676F
Mov al,87h
Out dx,al
Out dx,al
;-----
Mov al,07h         ; Select registers of watchdog timer
Out dx,al
Inc dx
Mov al,08h
Out dx,al
;-----
Dec dx            ; Enable the function of watchdog timer
Mov al,30h
Out dx,al
Inc dx
In al,dx
Or al,03h
Out dx,al
;-----
Dec dx           ; Set second as counting unit
Mov al,0f5h
Out dx,al
Inc dx
In al,dx
And al,not 08h
Out dx,al
;-----
Dec dx           ; Set timeout interval as 10 seconds and start counting
Mov al,0f6h

```

```

Out    dx,al
Inc    dx
Mov    al,10      ; 10 seconds
Out    dx,al

```

```

;-----
Dec dx          ; Lock NCT6776F
Mov    al,0aah
Out    dx,al

```

2. Enable watchdog timer and set 5 minutes as timeout interval

```

;-----
Mov dx,2eh      ; Unlock NCT6776F
Mov al,87h
Out dx,al
Out dx,al

```

```

;-----
Mov al,07h      ; Select registers of watchdog timer
Out    dx,al
Inc    dx
In     al,dx
Or     al,08h
Out    dx,al

```

```

;-----
Dec dx          ; Enable the function of watchdog timer
Mov    al,30h
Out    dx,al
Inc    dx
Mov    al,03h
Out    dx,al

```

```

;-----
Dec dx          ; Set minute as counting unit
Mov    al,0f5h
Out    dx,al
Inc    dx
In     al,dx
Or     al,08h
Out    dx,al

```

```

;-----
Dec dx          ; Set timeout interval as 5 minutes and start counting
Mov    al,0f6h
Out    dx,al
Inc    dx
Mov    al,5      ; 5 minutes
Out    dx,al

```

```

;-----

```

```
Dec dx          ; Lock NCT6776F
Mov  al,0aah
Out  dx,al
```

3. Enable watchdog timer to be reset by mouse

```
-----
Mov dx,2eh      ; Unlock NCT6776F
Mov al,87h
Out dx,al
Out dx,al
-----
Mov al,07h      ; Select registers of watchdog timer
Out  dx,al
Inc  dx
Mov  al,08h
Out  dx,al
-----
Dec dx          ; Enable the function of watchdog timer
Mov  al,30h
Out  dx,al
Inc  dx
In   al,dx
Or   al,03h
Out  dx,al
-----
Dec dx          ; Enable watchdog timer to be reset by mouse
Mov  al,0f7h
Out  dx,al
Inc  dx
In   al,dx
Or  al,80h
Out  dx,al
-----
Dec dx          ; Lock NCT6776F
Mov  al,0aah
Out  dx,al
```

4. Enable watchdog timer to be reset by keyboard

```
-----
Mov dx,2eh      ; Unlock NCT6776F
Mov al,87h
Out dx,al
Out dx,al
-----
Mov al,07h      ; Select registers of watchdog timer
```



```

Out    dx,al
Inc    dx
Mov    al,08h
Out    dx,al

```

```

;-----
Dec dx          ; Enable the function of watchdog timer

```

```

Mov    al,30h
Out    dx,al
Inc    dx
Mov    al,03h
Out    dx,al

```

```

;-----
Dec dx          ; Enables watchdog timer to be strobe reset by keyboard

```

```

Mov    al,0f7h
Out    dx,al
Inc    dx
In     al,dx
Or    al,40h
Out    dx,al

```

```

;-----
Dec dx          ; Lock NCT6776F

```

```

Mov    al,0aah
Out    dx,al

```

5. Generate a time-out signal without timer counting

```

;-----
Mov dx,2eh      ; Unlock NCT6776F

```

```

Mov al,87h
Out dx,al
Out dx,al

```

```

;-----
Mov al,07h      ; Select registers of watchdog timer

```

```

Out    dx,al
Inc    dx
Mov    al,08h
Out    dx,al

```

```

;-----
Dec dx          ; Enable the function of watchdog timer

```

```

Mov    al,30h
Out    dx,al
Inc    dx
Mov    al,03h
Out    dx,al

```

```

;-----
Dec dx          ; Generate a time-out signal

```

```
Mov    al,0f7h
Out    dx,al    ;Write 1 to bit 5 of F7 register
Inc    dx
In     al,dx
Or    al,20h
Out    dx,al
;-----
Dec dx    ; Lock NCT6776F
Mov    al,0aah
Out    dx,al
```

Appendix **B**

I/O Pin Assignments

B.1 Parallel Port Connector (LPT1)

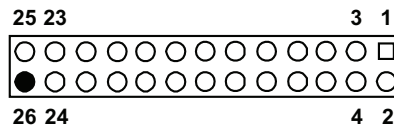

Table B.1: Parallel port connector (LPT1)

Pin	Signal	Pin	Signal
1	STROBE*	2	AUTOFD*
3	D0	4	ERR
5	D1	6	INIT*
7	D2	8	SLCTINI*
9	D3	10	GND
11	D4	12	GND
13	D5	14	GND
15	D6	16	GND
17	D7	18	GND
19	ACK*	20	GND
21	BUSY	22	GND
23	PE	24	GND
25	SLCT	26	N/C

* low active

B.2 VGA Connector (VGA1)

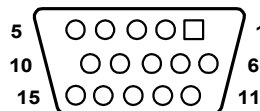

Table B.2: VGA connector (VGA1)

Pin	Signal	Pin	Signal
1	RED	9	VCC
2	GREEN	10	GND
3	BLUE	11	N/C
4	N/C	12	SDT
5	GND	13	H-SYNC
6	GND	14	V-SYNC
7	GND	15	SCK
8	GND		

B.3 RS 232 Serial Port (COM2)

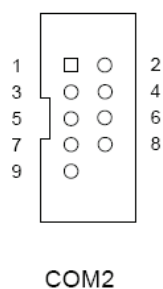

Table B.3: RS-232 serial port (COM2)

Pin	Signal
1	DCD
2	DSR
3	SIN
4	RTS
5	SOUT
6	CTS
7	DTR
8	RI
9	GND

B.4 USB Header (USB12 ~ 78)

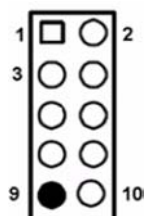

Table B.4: USB Header (USB12 ~ 78)

Pin	Signal	Pin	Signal
1	USB1_VCC5	6	USB2_D+
2	USB2_VCC5	7	GND
3	USB1_D-	8	GND
4	USB2_D-	9	Key
5	USB1_D+	10	NC

B.5 PS/2 Keyboard/Mouse Connector (KBMS1)

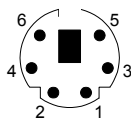

Table B.5: PS/2 keyboard/mouse connector (KBMS1)

Pin	Signal
1	KB DATA
2	MS DATA
3	GND
4	VCC
5	KB CLOCK
6	MS CLOCK

B.6 External Keyboard Connector (KBMS2)

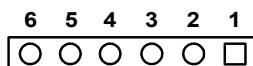

Table B.6: External keyboard connector (KBMS2)

Pin	Signal
1	KBCLK
2	KBDAT
3	MSDAT
4	GND
5	MSVCC
6	MSCLK

B.7 CPU Fan Power Connector (CPUFAN1)

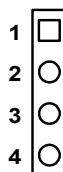

Table B.7: CPU fan power connector (CPUFAN1)

Pin	Signal
1	GND
2	+12V
3	Detect
4	NC

B.8 Power LED and Keyboard Lock Connector (JFP3 / PWR_LED & KEY LOCK)

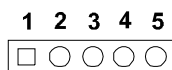

Table B.8: Power LED and keyboard lock connector (JFP3 / PWR_LED & KEY LOCK)

Pin	Signal
1	LED power (+3.3 V)
2	NC
3	SUPLLED
4	KEYLOCK#
5	GND

B.9 External Speaker Connector (JFP2 / SPEAKER)

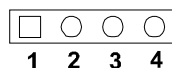

Table B.9: External speaker connector (JFP2 / SPEAKER)

Pin	Signal
1	SPK_CN17P1
2	SPK_CN17P2
3	SPK_CN17P3
4	SPK_CN17P4

B.10 Reset Connector (JFP1 / RESET)

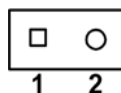

Table B.10: Reset connector (JFP1 / RESET)

Pin	Signal
1	RESET #
2	GND

B.11 HDD LED (JFP2 / HDDLED)

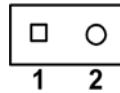

Table B.11: HDD LED (JFP2 / HDDLED)

Pin	Signal
1	HDD LED
2	SATA LED

B.12 ATX Soft Power Switch (JFP1 / PWR_SW)

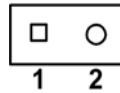

Table B.12: ATX soft power switch (JFP1 / PWR_SW)

Pin	Signal
1	5VSB
2	PWR-BTN

B.13 Hi-definition Audio Link Connector (HDAUD1)

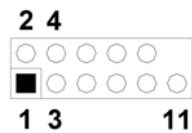

Table B.13: Hi-definition audio link connector (HDAUD1)

Pin	Signal	Pin	Signal
1	ACZ_VCC	2	GND
3	ACZ_SYNC	4	ACZ_BITCLK
5	ACZ_SDOUT	6	ACZ_SDIN0
7	ACZ_SDIN1	8	-ACZ_RST
9	ACZ_12V	10	GND
11	GND	12	N/C

B.14 SM Bus Connector (JFP2 / SNMP)

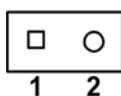

Table B.14: SM bus connector (JFP2 / SNMP)

Pin	Signal
1	SMB_DATA
2	SMB_CLK

B.15 LAN1 and LAN2 LED Connector (LANLED1)

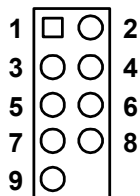

Table B.15: LAN1 and LAN2 LED connector (LANLED1)

Pin	Signal
1	#LAN1_ACT
2	#LAN2_ACT
3	V33_AUX
4	V33_AUX
5	#LAN1_LINK1000
6	#LAN2_LINK1000
7	#LAN1_LINK100
8	#LAN2_LINK100
9	V33_AUX

B.16 GPIO Header (GPIO1)

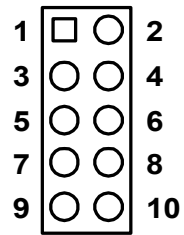

Table B.16: GPIO header (GPIO1)

Pin	Signal
1	SIO_GPIO0
2	SIO_GPIO4
3	SIO_GPIO1
4	SIO_GPIO5
5	SIO_GPIO2
6	SIO_GPIO6
7	SIO_GPIO3
8	SIO_GPIO7
9	VCC_GPIO
10	GND

B.17 System I/O Ports

Table B.17: System I/O ports

Addr. range (Hex)	Device
00h-1Fh	DMA Controller
20h-2Dh	Interrupt Controller
2E-2F	LPC SIO
30h-42h	Interrupt Controller
43h	Timer/Counter
4E-4F	LPC SIO
50h-53h	Timer/Counter
60h-66h	Microcontroller
70h-77h	RTC Controller
80h-91h	DMA Controller
92h	Reset Generator
93h-9Fh	DMA Controller
A0h-B1h	Interrupt Controller
B2h-B3h	Power Management
B4h-BDh	Interrupt Controller
C0h-DHh	DMA Controller
F0h	Interrupt Controller
1F0h-1F7h	SATA Controller or PCI
290h-29Fh	H/W Monitor
376h-3F6h	SATA Controller or PCI
4D0h-4D1h	Interrupt Controller
C80h-CBFh	Com3-Com6
3F8-3FF	Com1
2F8-2F0	Com2
4700-470F	TPM
600h-67Fh	SMSC Secondary I/O used

B.18 DMA Channel Assignments

Table B.18: DMA channel assignments

Channel	Signal
0	Available
1	Available
2	Floppy disk (8-bit transfer)
3	Available
4	Cascade for DMA controller 1
5	Available
6	Available
7	Available

B.19 Interrupt Assignments

Table B.19: Interrupt assignments

Priority	Interrupt#	Interrupt source
1	NMI	Parity error detected
2	IRQ0	Interval timer
3	IRQ1	Keyboard
-	IRQ2	Interrupt from controller 2 (cascade)
4	IRQ8	Real-time clock
5	IRQ9	Cascaded to INT 0A (IRQ 2)
6	IRQ10	Serial Port 4, 6
7	IRQ11	Serial Port 3, 5
8	IRQ12	PS/2 mouse
9	IRQ13	INT from co-processor
10	IRQ14	Primary IDE Channel
11	IRQ15	Secondary IDE Channel
12	IRQ3	Serial communication port 2
13	IRQ4	Serial communication port 1
14	IRQ5	NA
15	IRQ6	NA
16	IRQ7	Parallel port 1 (print port)

B.20 1st MB Memory Map

Table B.20: 1st MB memory map

Addr. range (Hex)	Device
E0000h - FFFFFh	BIOS
CF000h - 0FFFFh	Unused
C0000h - CBFFFh	VGA BIOS
A0000h - BFFFFh	Video Memory
00000h - 9FFFFh	Base memory

B.21 PCI Bus Map

Table B.21: PCI bus map

Signal	IDSEL	INT# pin	GNT	REQ
PCI slot 1	AD31	INT B,C,D,A	GNT A	REQ A
PCI slot 2	AD30	INT C, D, A, B	GNT B	REQ B
PCI slot 3	AD29	INT D,A,B,C	GNT C	REQ C
PCI slot 4	AD28	INT A, B, C, D	GNT D	REQ D

Appendix **C**

Programming the
GPIO

C.1 Supported GPIO Register

Below are the detailed descriptions of the GPIO addresses and programming sample.

C.2 GPIO registers

Bank	Offset	Description
09h	30h	Write 1 to bit 7 to enable GPIO
07h	E0h	GPIO I/O Register When set to a '1', respective GPIO port is programmed as an input port. When set to a '0', respective GPIO port is programmed as an output port.
07h	E1h	GPIO Data Redister If a port is programmed to be an output port, then its respective bit can be read/written. If a port is programmed to be an input port, then its respective bit can only be read.
07h	E2h	GPIO Inversion Register When set to a '1', the incoming/outgoing port value is inverted. When set to a '0', the incoming/outgoing port value is the same as in data register.

C.3 GPIO example program-1

Enter the extended function mode, interruptible double-write

```
MOV DX,2EH  
MOV AL,87H  
OUT DX,AL  
OUT DX,AL
```

Configure logical device, configuration register CRE0,CRE1,CRE2

```
MOV DX,2EH  
MOV AL,09H  
OUT DX,AC  
DEC DX  
MOV AL,30H  
OUT DX,AL  
INC DX  
IN AL,DX  
OR AL,10000000B  
DEC DX  
MOV AL,07H  
OUT DX,AL
```

```
INC DX
MOV AL,07H ; Select logical device 7
OUT DX,AL ;
DEC DX
MOV AL,E0H
OUT DX,AL
INC DX
MOV AL,00H ; 1:Input 0:output for GPIO respective
OUT DX,AL
DEC DX
MOV AL,E2H ;
OUT DX,AL
INC DX
MOV AL,00H ;Set GPIO is normal not inverter
OUT DX,AL;
DEC DX
MOV AL,E1H
OUT DX,AL
INC DX
MOV AL,??H ; Put the output value into AL
OUT DX,AL

-----
Exit extended function mode |
-----

MOV DX,2EH
MOV AL,AAH
OUT DX,AL
```

ADVANTECH

Enabling an Intelligent Planet

www.advantech.com

Please verify specifications before quoting. This guide is intended for reference purposes only.

All product specifications are subject to change without notice.

No part of this publication may be reproduced in any form or by any means, electronic, photocopying, recording or otherwise, without prior written permission of the publisher.

All brand and product names are trademarks or registered trademarks of their respective companies.

© Advantech Co., Ltd. 2011