

GSID600A120S4B1

Half-Bridge IGBT Module



Features:

- Short Circuit Rated 10 μ s
- Low Saturation Voltage: $V_{CE(sat)} = 1.80V @ I_C = 450A, T_C=25^\circ C$
- Low Switching Loss
- 100% RBSOA Tested ($2 \times I_C$)
- Low Stray Inductance
- Lead Free, Compliant with RoHS Requirement



Applications:

- High Power Converters
- Motor Drivers
- UPS Systems
- Wind Turbines

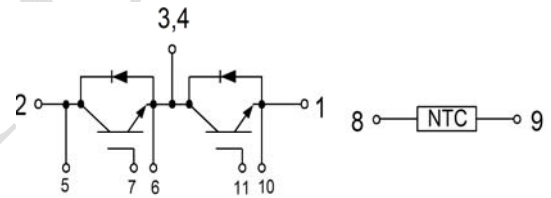

IGBT, Inverter

Maximum Rated Values ($T_C=25^\circ C$ unless otherwise specified)

V_{CES}	Collector-Emitter Blocking Voltage		1200	V
V_{GES}	Gate-Emitter Voltage		± 20	V
I_C	Continuous Collector Current	$T_C = 80^\circ C$	600	A
		$T_C = 25^\circ C$	1130	A
$I_{CM(1)}$	Peak Collector Current Repetitive	$T_J = 175^\circ C$	1200	A
P_D	Maximum Power Dissipation per IGBT	$T_C = 25^\circ C$ $T_{Jmax} = 175^\circ C$	3060	W

Electrical Characteristics of IGBT ($T_C=25^\circ\text{C}$ unless otherwise specified)

Static characteristics

Symbol	Description	Conditions	Min	Typ	Max	Unit	
$V_{GE(th)}$	Gate-Emitter Threshold Voltage	$I_C = 10\text{ mA}, V_{CE} = V_{GE}$	5.0	5.5	6.8	V	
$V_{CE(sat)}$	Collector-Emitter Saturation Voltage	$I_C = 600\text{A}, V_{GE} = 15\text{V}$	$T_J = 25^\circ\text{C}$		1.8	2.10	V
			$T_J = 125^\circ\text{C}$		2.10		V
			$T_J = 150^\circ\text{C}$		2.20		V
I_{CES}	Collector-Emitter Leakage Current	$V_{GE} = 0\text{V}, V_{CE} = V_{CES}, T_J = 25^\circ\text{C}$			1	mA	
I_{GES}	Gate-Emitter Leakage Current	$V_{GE} = \pm 20\text{V}, V_{CE} = 0\text{V}, T_J = 25^\circ\text{C}$			400	nA	
C_{ies}	Input Capacitance	$V_{CE} = 25\text{V}, V_{GE} = 0\text{V}, f = 1\text{MHz}$		51.0		nF	
C_{oes}	Output capacitance			3.30		nF	

Switching Characteristics

$t_{d(on)}$	Turn-on Delay Time	$V_{CC} = 600\text{V}, I_C = 600\text{A}, R_G = 5\Omega, V_{GE} = \pm 15\text{V}, \text{Inductive Load}$	$T_J = 25^\circ\text{C}$		1340		ns
			$T_J = 125^\circ\text{C}$		1270		
			$T_J = 150^\circ\text{C}$		1265		
t_r	Rise Time		$T_J = 25^\circ\text{C}$		195		ns
			$T_J = 125^\circ\text{C}$		205		
			$T_J = 150^\circ\text{C}$		185		
$t_{d(off)}$	Turn-off Delay Time		$T_J = 25^\circ\text{C}$		1020		ns
			$T_J = 125^\circ\text{C}$		1050		
			$T_J = 150^\circ\text{C}$		1070		
t_f	Fall Time		$T_J = 25^\circ\text{C}$		175		ns
			$T_J = 125^\circ\text{C}$		190		
			$T_J = 150^\circ\text{C}$		195		
E_{on}	Turn-on Switching Loss	$T_J = 25^\circ\text{C}$		16.9		mJ	
		$T_J = 125^\circ\text{C}$		22.4			
		$T_J = 150^\circ\text{C}$		24.2			

E _{off}	Turn-off Switching Loss	V _{CC} = 600V, I _C = 600A, R _G = 5Ω, V _{GE} = ±15V, Inductive Load	T _J = 25°C	101.0	mJ
			T _J = 125°C	120.6	
			T _J = 150°C	124.7	
Q _g	Total Gate Charge		T _J = 25°C	3640	nC
RBSOA	Reverse Bias Safe Operation Area	I _C =1200A, V _{CC} =960V, V _p =1200V, R _g = 15Ω, V _{GE} =+15V to 0V, T _J =150°C	Trapezoid		
SCSOA	SCSOA	V _{CC} = 600V, V _{GE} = 15V, T _J = 150°C	10		μs
R _{θJC}	IGBT Thermal Resistance: Junction-To-Case			0.05	°C/W

Maximum Rated Values of Diode (T_C=25°C unless otherwise specified)

V _{RRM}	Repetitive Peak Reverse Voltage	1200	V
I _F	Diode Continuous Forward Current	600	A
I _{FM}	Repetitive Peak Forward Current	1200	A

Electrical Characteristics of FWD (T_C=25°C unless otherwise specified)

Symbol	Description	Conditions	Min	Typ	Max	Unit
V _{FM}	Forward Voltage	I _F = 600A, V _{GE} = 0V	T _J = 25°C	2.00	2.30	V
			T _J = 125°C		2.20	
			T _J = 150°C		2.15	
I _{rr}	Peak Reverse Recovery Current		T _J = 25°C	205		A
			T _J = 125°C	290		
			T _J = 150°C	305		
Q _{rr}	Reverse Recovery Charge	I _F =600A, di/dt =2900A/μs, V _{rr} = 600V, V _{GE} = -15V	T _J = 25°C	25.6		μC
			T _J = 125°C	52.8		
			T _J = 150°C	61.4		
E _{rec}	Reverse Recovery Energy		T _J = 25°C	13.5		mJ
			T _J = 125°C	27.6		
			T _J = 150°C	31.7		
R _{θJC}	Diode Thermal Resistance: Junction-To-Case			0.10		°C/W

Internal NTC-Thermistor Characteristics

Symbol	Description	Min	Typ	Max	Unit
R ₂₅	T _C =25°C		5		kΩ
ΔR/R	T _C =100°C, R ₁₀₀ =481Ω			±5	%
P ₂₅	T _C =25°C		50		mW
B _{25/50}	$R_2=R_{25} \exp[B_{25/50}(1/T_2-1/(298.15K))]$		3380		K
B _{25/80}	$R_2=R_{25} \exp[B_{25/80}(1/T_2-1/(298.15K))]$		3440		K

Module

Symbol	Description	Min	Typ	Max	Unit
V _{iso}	Isolation Voltage(All Terminals Shorted) f = 50Hz, 1minute			2500	V
T _J	Maximum Junction Temperature			175	°C
T _{JOP}	Maximum Operating Junction Temperature Range	-40		+150	°C
T _{stg}	Storage Temperature	-40		+125	°C
R _{θCS}	Case-To-Sink (Conductive Grease Applied)		0.1		°C/W
M	Mounting Screw:M5	3.0		5.0	N·m
M	Power Terminals Screw: M6	4.0		6.0	N·m
G	Weight		330		g

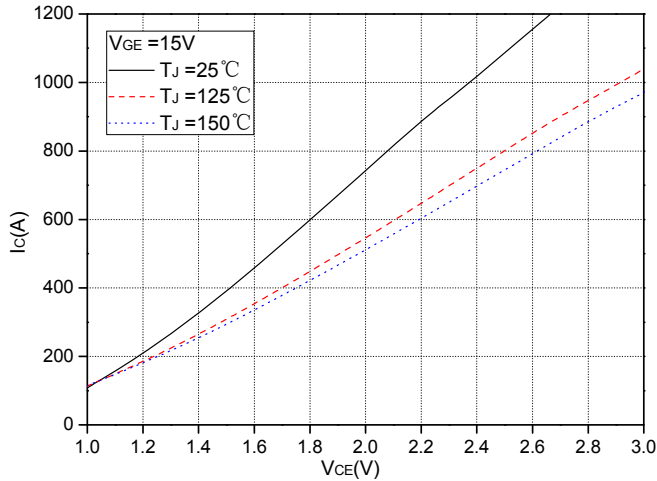

Fig.1 Typical Saturation Voltage Characteristics

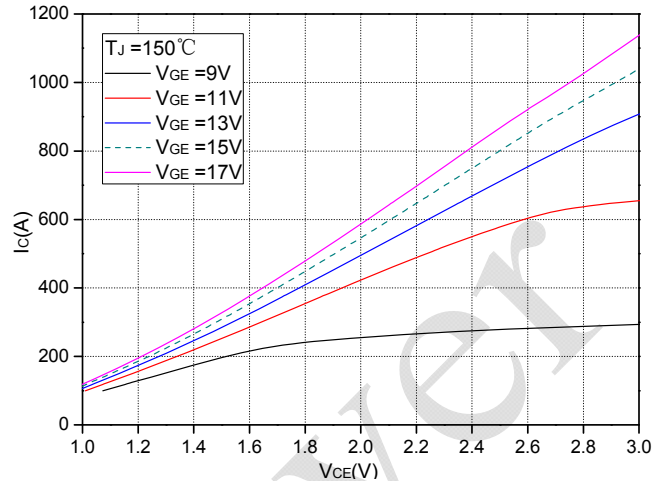

Fig.2 Typical Output Characteristics

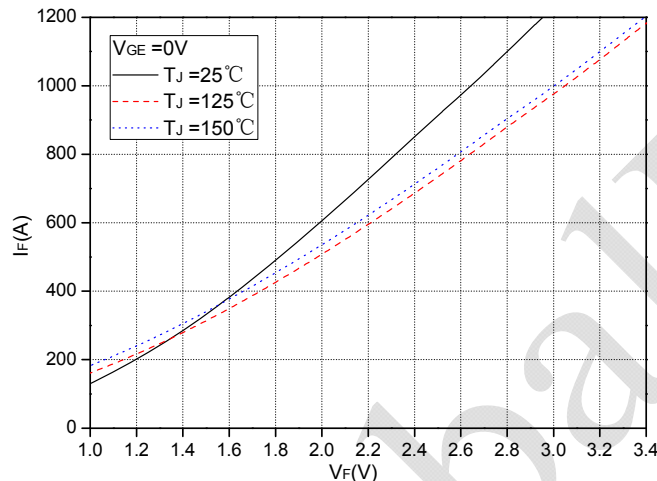

Fig.3 Forward Characteristics of Diode

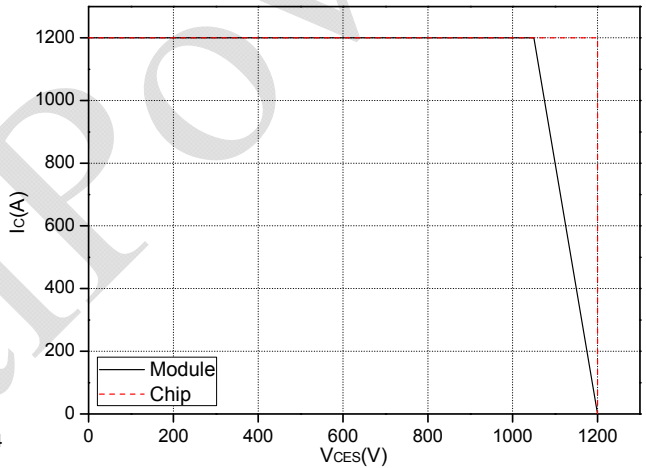

Fig.4 Reverse Bias Safe Operation Area (RBSOA)

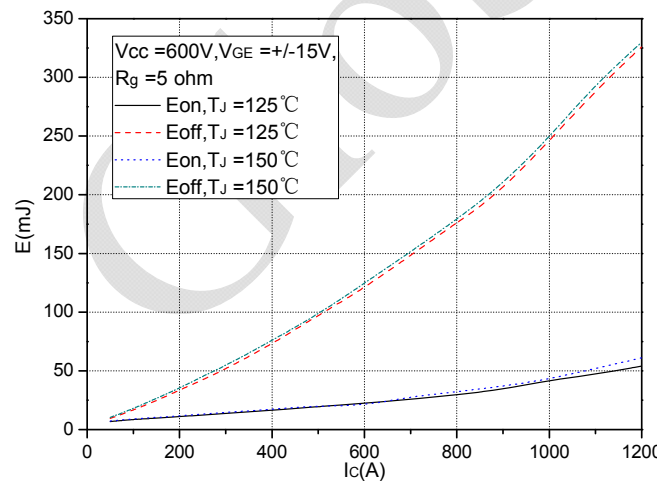

Fig.5 Typical Switching Loss vs. Collector Current

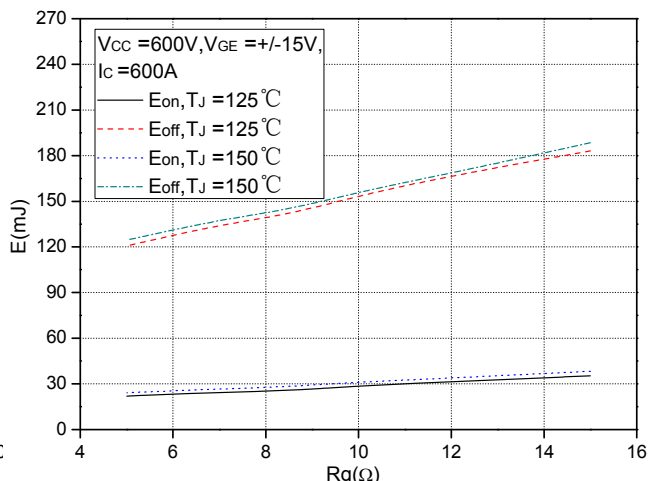

Fig.6 Typical Switching Loss vs. Gate Resistance

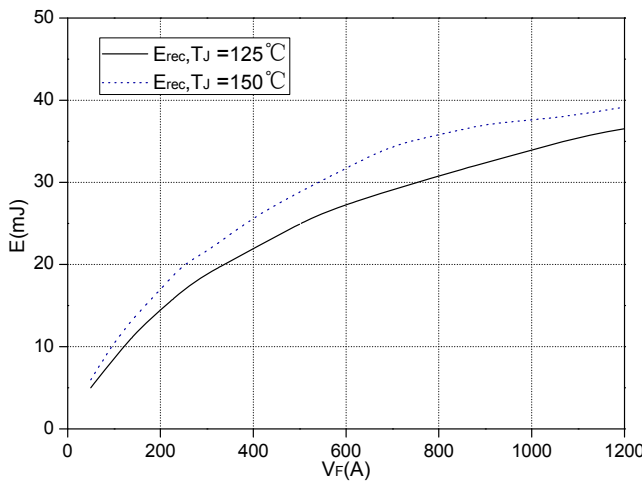

Fig.7 Typical Switching Loss vs. Collector Current

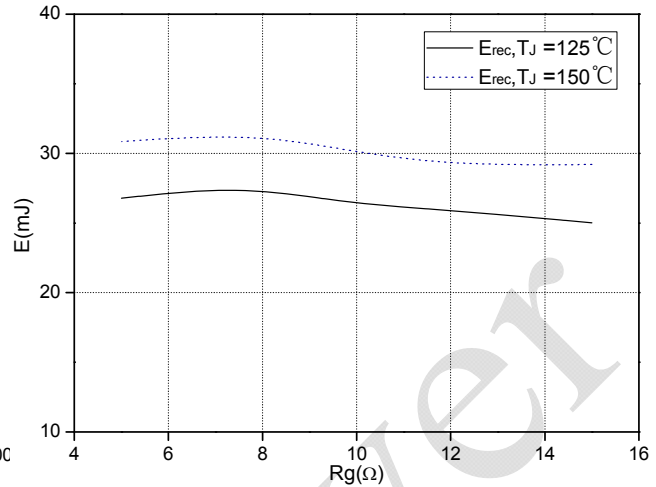

Fig.8 Typical Switching Loss vs. Gate Resistance

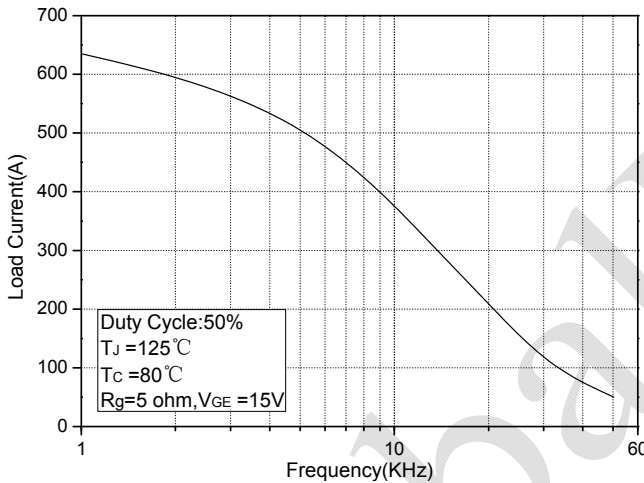

Fig.9 Typical Load Current vs. Frequency

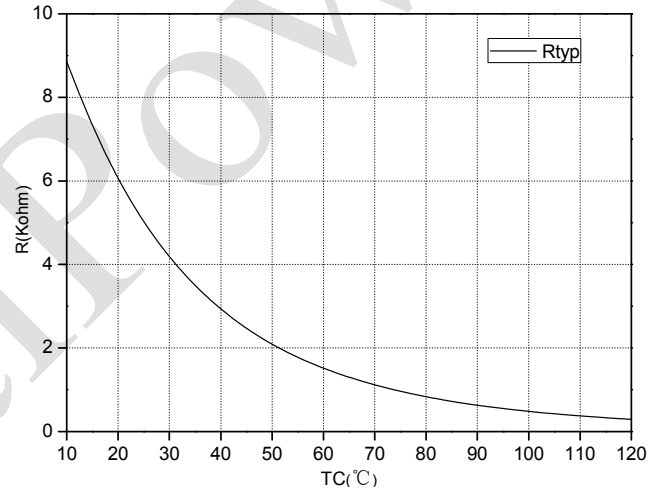

Fig.10 NTC Temperature characteristics

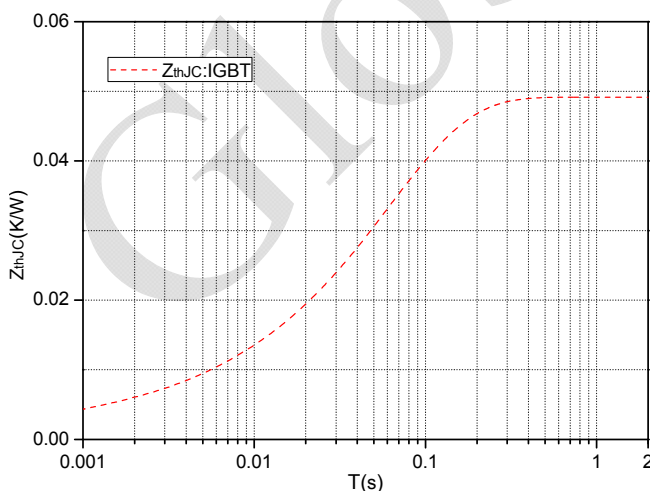

Fig.11 Transient thermal impedance (IGBT)

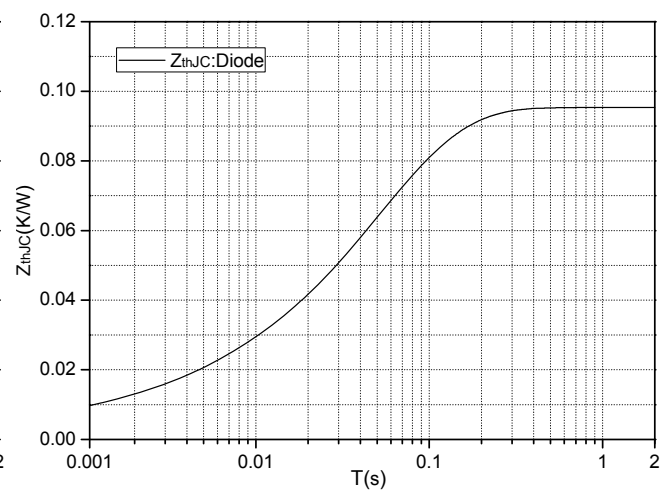

Fig.12 Transient thermal impedance (Diode)

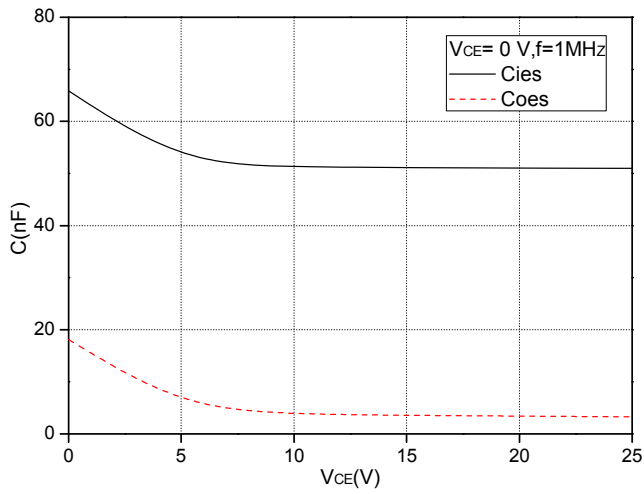
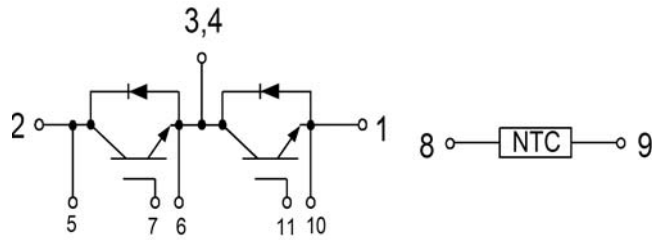

Fig.13 Capacitance Characteristics

GlobalPower

Internal Circuit



Package Outline (Unit: mm):

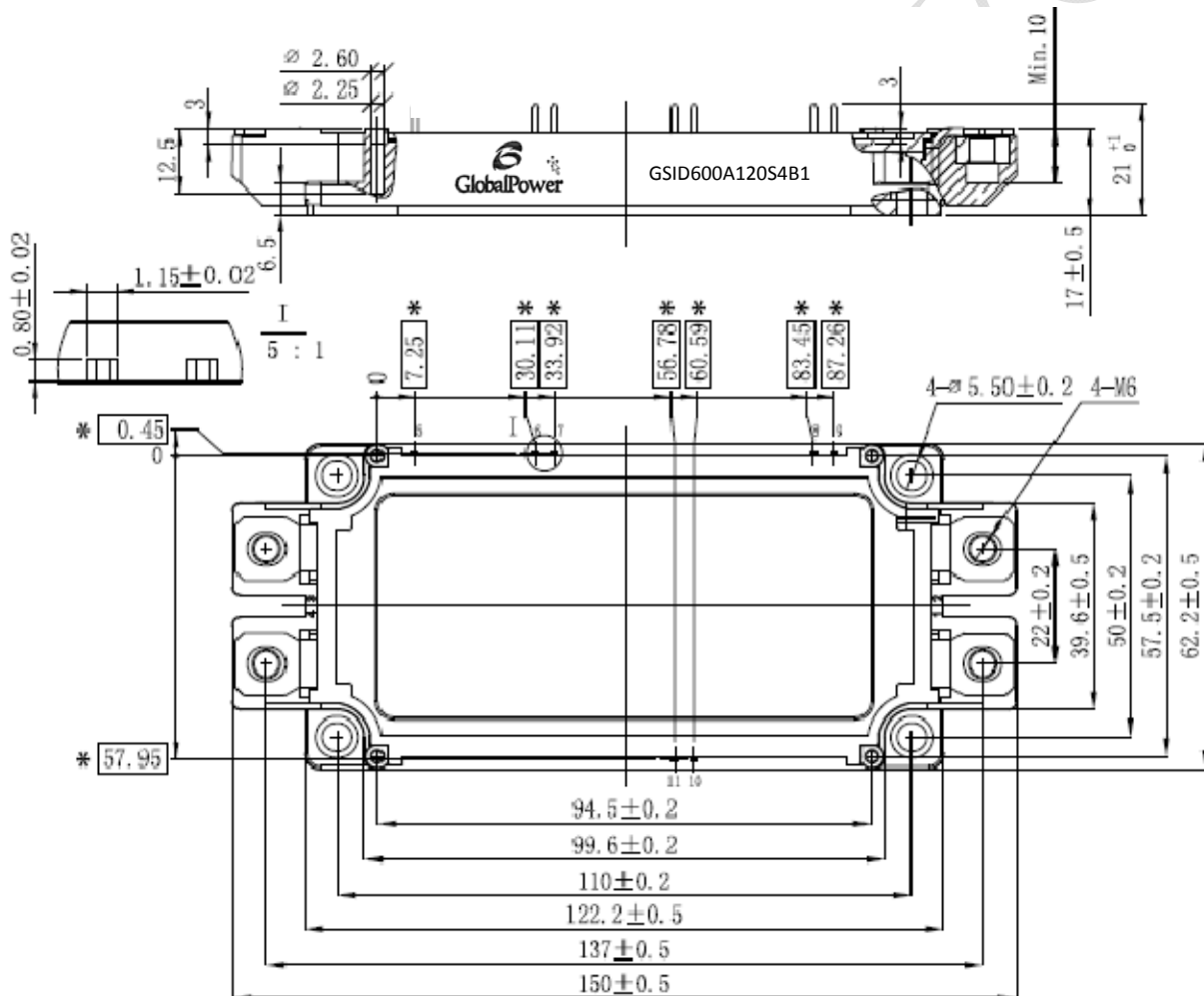

Revision History

Date	Revision	Notes
05/11/2015	0.1	Initial release of preliminary datasheet.
12/21/2015	0.2	Add SCSOA specification

Global Power Technologies Group

20692 Prism Place
 Lake Forest, CA 92630
 TEL (949) 207-7500
 FAX (949) 613-7600
 E-mail: info@gptechnology.com
 Web site: www.gptechnology.com



Notes

- **RoHS Compliance**
 The levels of RoHS restricted materials in this product are below the maximum concentration values (also referred to as the threshold limits) permitted for such substances, or are used in an exempted application, in accordance with EU Directive 2011/65/EC (RoHS2), as implemented March, 2013. RoHS Declarations for this product can be obtained from the Product Documentation sections of www.gptechnology.com.
- **REACH Compliance**
 REACH substances of high concern (SVHCs) information is available for this product. Since the European Chemical Agency (ECHA) has published notice of their intent to frequently revise the SVHC listing for the foreseeable future, please contact our office at GPTG Headquarters in Lake Forest, California to insure you get the most up-to-date REACH SVHC Declaration.
 REACH banned substance information (REACH Article 67) is also available upon request.
- This product has not been designed or tested for use in, and is not intended for use in, applications implanted into the human body nor in applications in which failure of the product could lead to death, personal injury or property damage, including but not limited to equipment used in the operation of nuclear facilities, life-support machines, cardiac defibrillators or similar emergency medical equipment, aircraft navigation or communication or control systems, or air traffic control.
- To obtain additional technical information or to place an order for this product, please contact us. The information in this datasheet is provided by Global Power Technologies Group. GPTG reserves the right to make changes, corrections, modifications, and improvements of datasheet without notice.