

USB/SD Host Audio Media Decoder Evaluation Board Manual

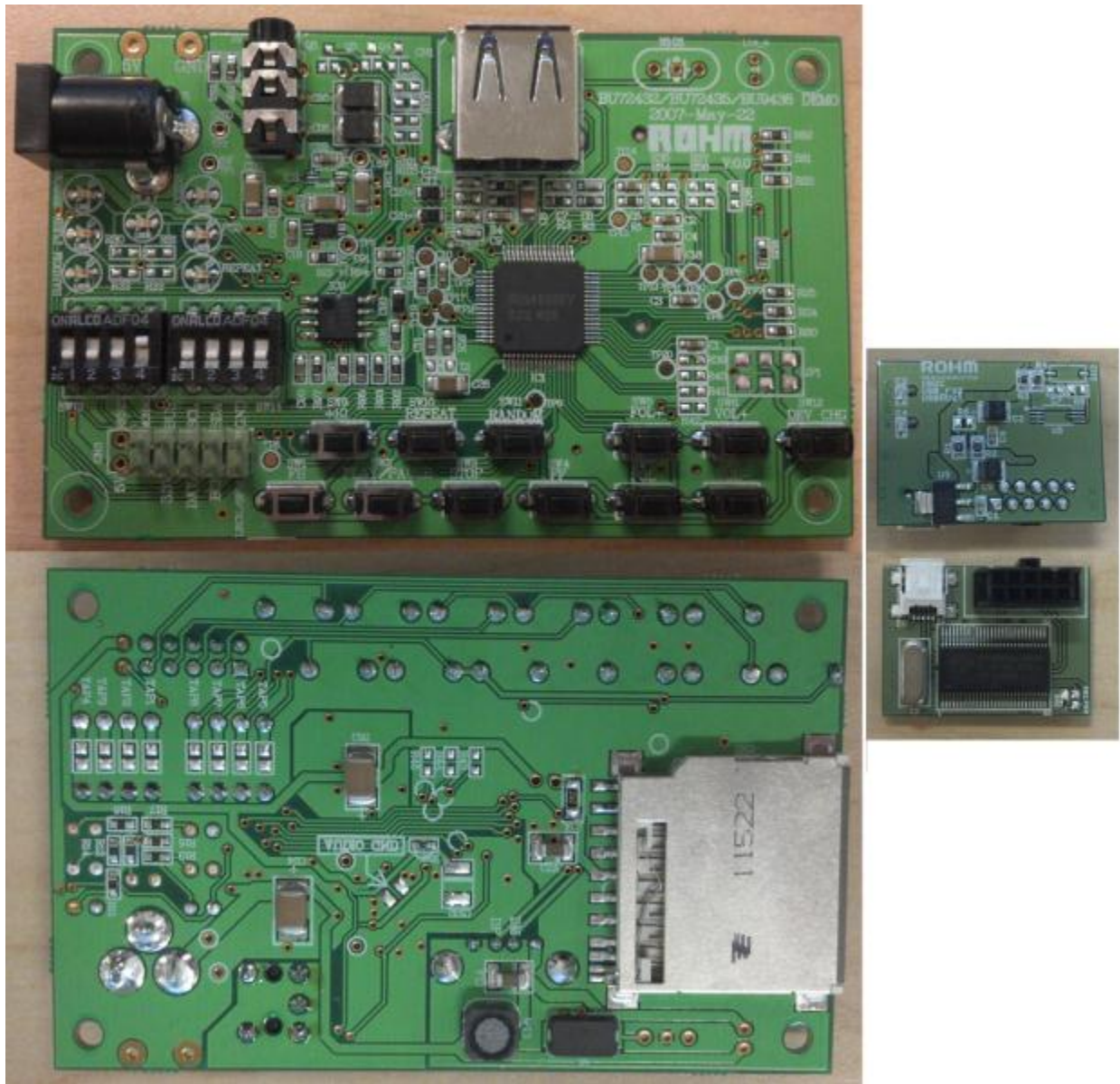

BU94603 USB Host Audio Media Decoder IC

Table of Contents

Revision History	2
Outline	3
Hardware	3
Software*	3
BU94603 Mode 1 “Stand Alone Mode” Setup Guide	4
BU94603 Mode 1 Pushbutton Explanation/Operation Guide	7
BU94603 Mode 2 “Slave Device Mode” Setup Guide.....	8
BU94603 Mode 2 “UHAP.exe” Explanation/Operation Guide	12
Appendix A. Connecting to the “USB-to-I2C Cypress Controller Board”	16
Appendix B. “UHAP.exe” GUI functions to I2C register command map.....	17
Appendix C. BU94603 Build of Materials (BoM).....	20
Appendix D. BU94603 Eval board Schematic Overview	23

Revision History

Version	Description	Date	Initials
A0	Updated document to USDC format and for new USDC board build	01/31/2013	KB/JC
A1	Appendix C/D added	2/25/2013	JC
A1.1	Software download at distributor	4/16/2013	JC

Outline

BU94603 is an AAC/WMA/MP3 decoder IC with built-in USB host Interface, SD memory card interface, audio DAC and system control functions. Using a pushbutton or I2C interface command, the IC reads an audio file written to a memory device within the onboard USB Interface or SD memory card. BU9458KV supports a “STAND ALONE MODE,” which utilizes commands entered from the pushbutton matrix (hereinafter referred to as MODE1), a “AUTO SLAVE MODE,” which is utilizes commands entered from a master microcomputer via the built-in I2C interface (hereinafter referred to as MODE2), and a “MANUAL SLAVE MODE,” which can send the memory device information to the master microcomputer via the I2C interface and completely control sequences (such as a play sequence) by the master microcomputer (hereinafter referred to as MODE3). BU9458KV also supports fast forward playing and fast backward playing with music. BU9458KV can outputs folder names, file names, ID3TAG (V1.0, V1.1 V2.2 V2.3 and V2.4) information and WMA-TAG information and AAC-TAG (iTunes Meta-data) information via the I2C interface. This function is enabled only in MODE 2 and MODE 3. BU9458KV supports audio line output, audio serial three-line (I2S) output and digital audio interface (SPDIF) output.

Hardware

BU94603 Evaluation Board: This board contains the BU94603 IC as well as the external components required to use the device properly.

USB-to-I2C Cypress Controller Board: This board connects to the PC to emulate an I2C controlled environment (used for device operation in modes 2 and 3)

Power Adapter: This evaluation board requires a 5V power supply; however, the chip is actually being supplied with a 3.3V source (regulator).

Software*

“UHAP.exe”: This program is a standalone application (no install required) that emulates a master I2C controller and demonstrates modes 2 and 3 of the BU94603. Requires Microsoft framework 2.0

For ROHM software download, please contact your evaluation board distributor.

*These software modules have been tested and verified on a 32bit and 64bit Windows 7 operating system

BU94603 Mode 1 “Stand Alone Mode” Setup Guide

Mode 1 operation (Stand Alone Mode) uses the evaluation board’s pushbuttons to control the actions of the BU94603.

1. Set the toggle switches to the following settings

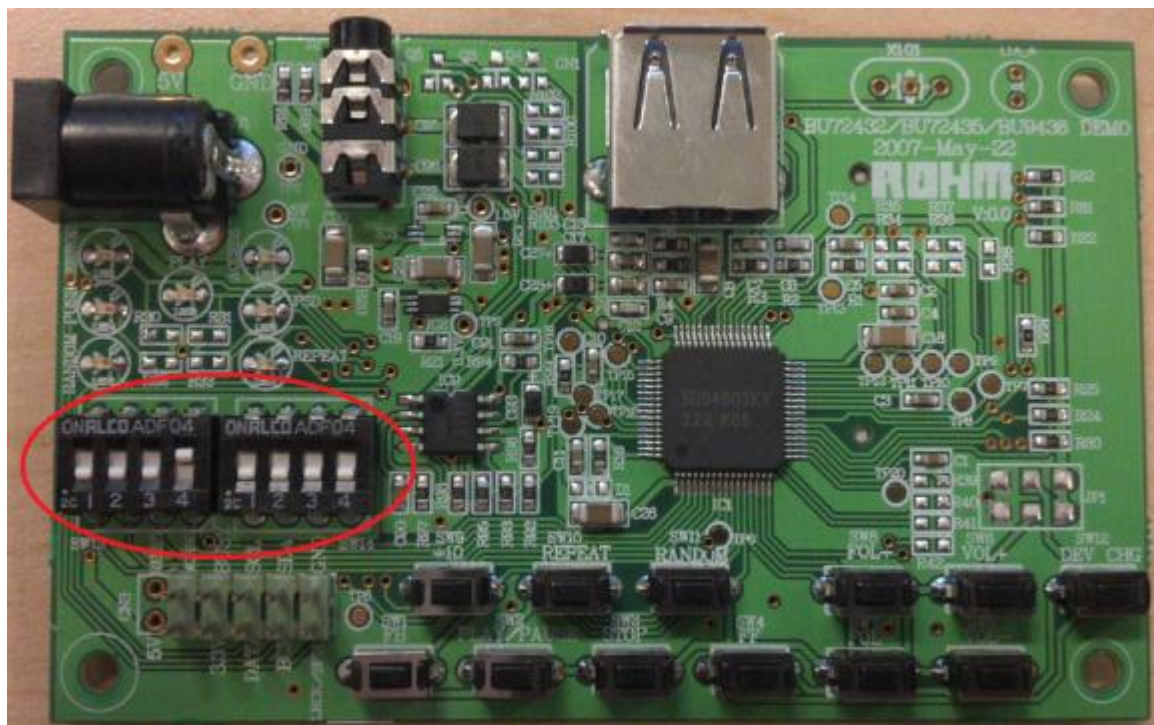

a.

SW13	Terminal Name	Setting
1	SEL_VOL	OFF (down position)
2	SEL_DOUT	OFF (down position)
3	SEL_MP3	OFF (down position)
4	SEL_SLAVE	OFF (down position)

SW14	Terminal Name	Setting
1	Test Terminal	-
2	SEL_SMAN	OFF (down position)
3	SEL_UTPKT	OFF (down position)
4	SEL_APLAY	OFF (down position)

b.

2. Connect memory containing audio files

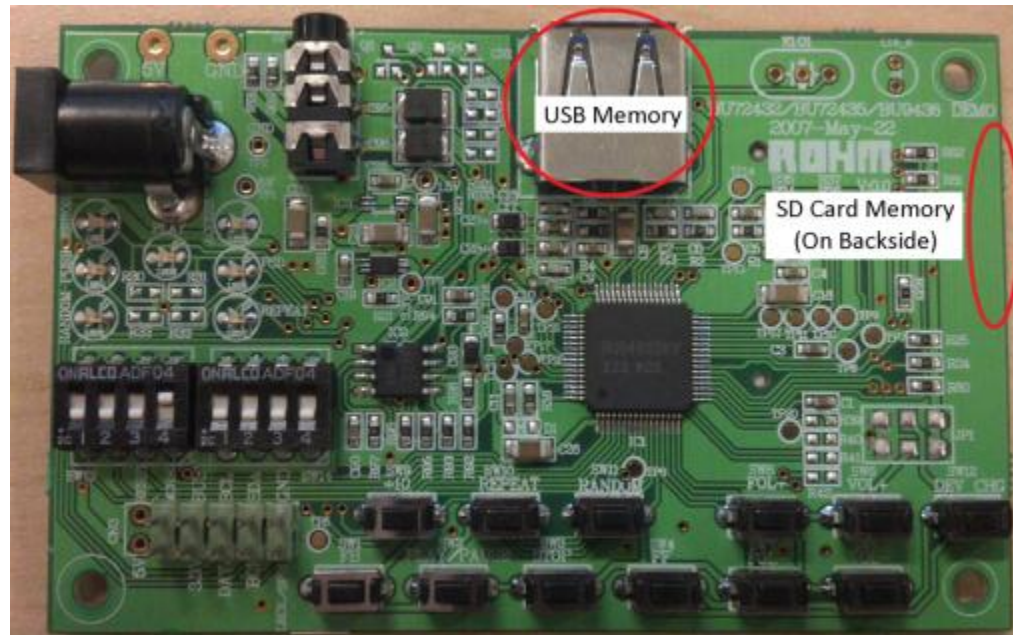

- a.
- b. USB memory, SD Card memory, or both can be connected while operating in mode 1. When both are connected to the BU94603, then files from the USB memory will be played first.

3. Connect headphones or speakers to the 3.5mm audio jack



- a.

4. Connect Power to the Evaluation Board



a.

BU94603 Mode 1 Pushbutton Explanation/Operation Guide

Once power has been connected to the device, using the pushbuttons will allow for different functions.

Please see the picture and table below for additional information on the operations of the different push buttons.

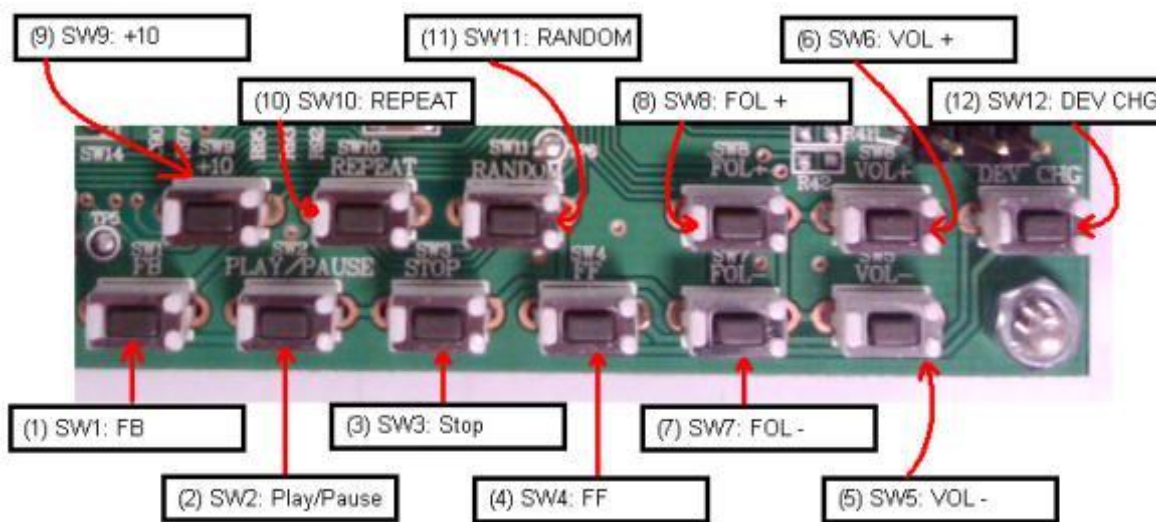

Pushbutton	PB Name	Description
SW1	FB	Stop playing current song and play the previous track
SW2	PLAY/PAUSE	Click once to begin playing. Press again to pause. Press again to resume playing (will not reset the track)
SW3	STOP	Once playing, clicking this button will reset the device
SW4	FF	Clicking this button will stop playing the current song and will play the next track
SW5	VOL-	Decrease Volume
SW6	VOL+	Increase Volume
SW7	FOL-	Play previous folder
SW8	FOL+	Play next folder
SW9	+10	Skip forward 10 tracks
SW10	REPEAT	Sets the repeat function. Press once to constantly repeat the current song (blinking LED). Press twice to repeat folder (solid LED)
SW11	RANDOM	Media will be played at random
SW12	DEV CHG	Functional only if both USB and SD memory devices are currently being used. Pressing this button will stop playback and change memory devices. Upon power up, the USB memory will be chosen.

BU94603 Mode 2 “Slave Device Mode” Setup Guide

Mode 2 operation (Slave Device Mode) uses the I2C interface control the actions of the BU94603. I2C commands are sent from the host PC application, “UHAP.exe” through a Cypress USB peripheral controller.

1. Set the toggle switches to the following settings

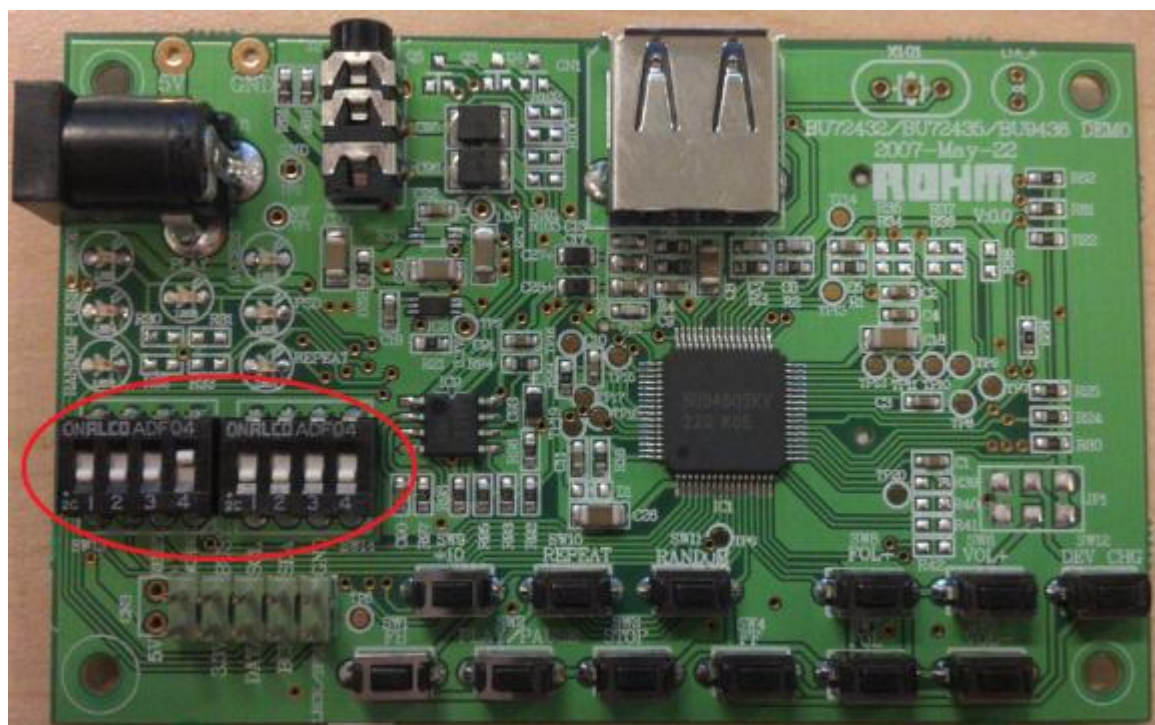

a.

SW13	Terminal Name	Setting
1	SEL_VOL	OFF (down position)
2	SEL_DOUT	OFF (down position)
3	SEL_MP3	OFF (down position)
4	SEL_SLAVE	ON (up position)

SW14	Terminal Name	Setting
1	Test Terminal	-
2	SEL_SMAN	OFF (down position)
3	SEL_UTPKT	OFF (down position)
4	SEL_APLAY	OFF (down position)

b.

2. Connect the “USB-to-I2C Cypress Controller Board”

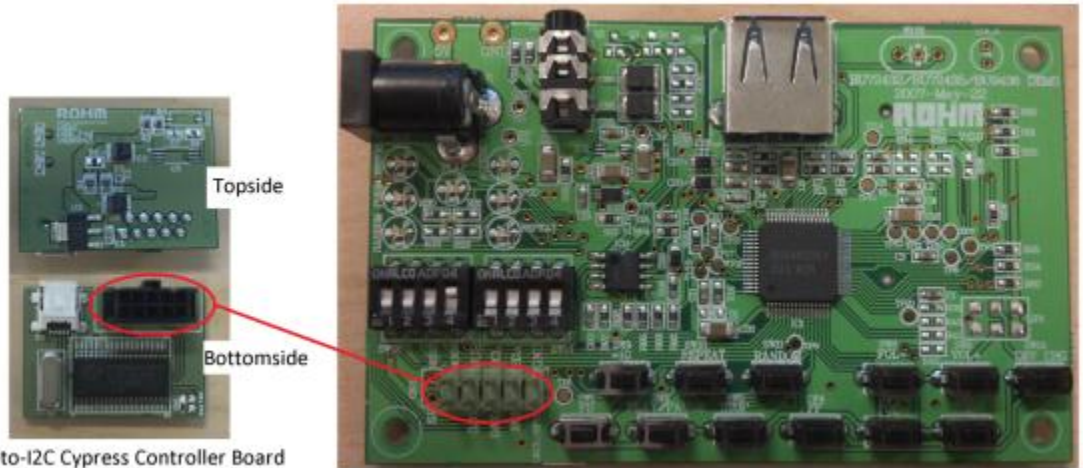

a. USB-to-I2C Cypress Controller Board

- b. When attaching the “USB-to-I2C Cypress Controller Board,” please be sure the board’s USB connection is facing the bottom of the board. When connected the board should look like the following:



c.

3. Connect memory containing audio files

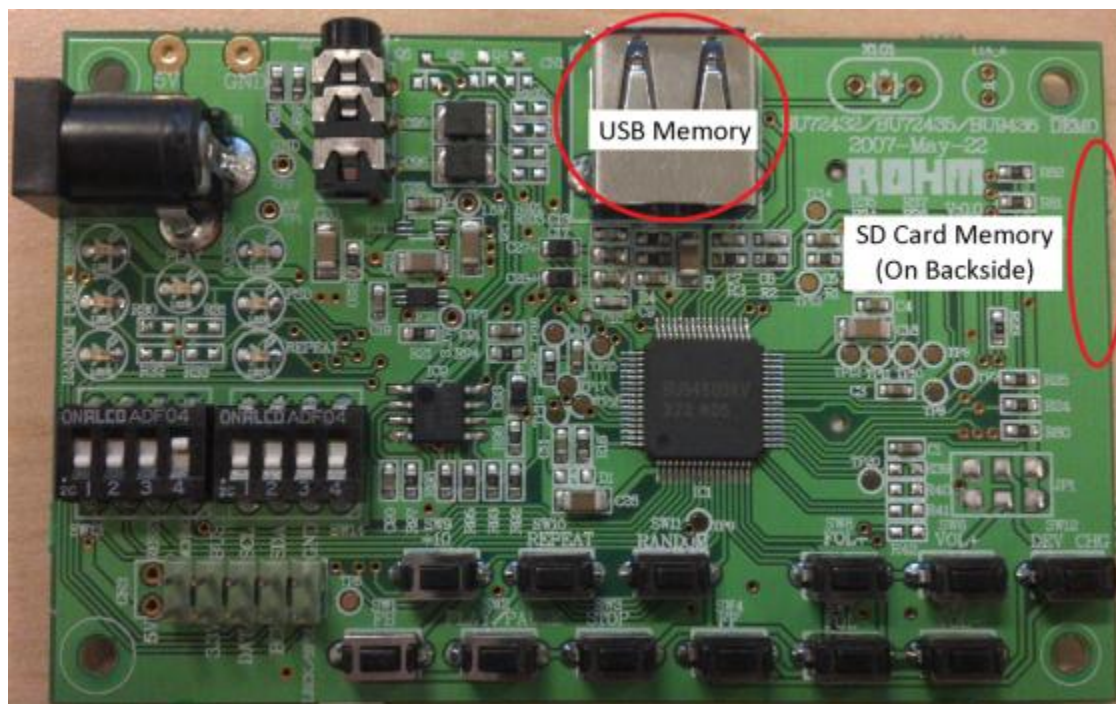

- a.
- b. USB memory, SD Card memory, or both can be connected while operating in mode 1. When both are connected to the BU94603, then files from the USB memory will be played first.

4. Connect headphones or speakers to the 3.5mm audio jack



- a.

5. Connect Power to the Evaluation Board

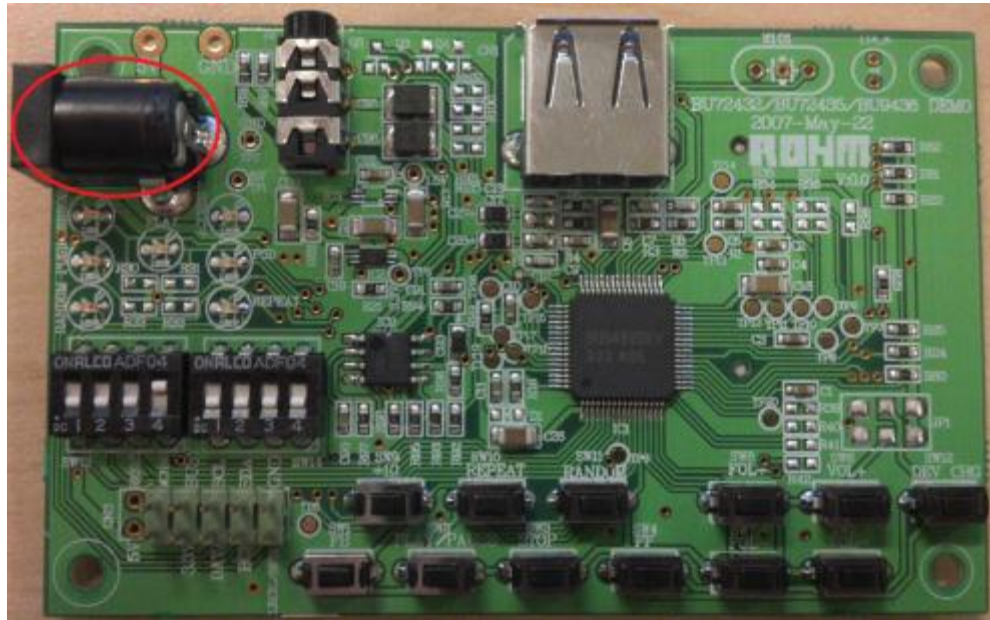

a.

6. Connect the mini-USB to PC USB jack.



a.

7. Open UHAP.exe

BU94603 Mode 2 “UHAP.exe” Explanation/Operation Guide

After all the mode 2 setup has been completed, UHAP.exe will be used to control the actions of this device. Please see below for an explanation of the “UHAP.exe” GUI interface



1. Play Status Information
 - a. This box will show information on the current playing song. Information includes media source, current play time, folder/file index, and current playback status
2. Current Track Information

- a. This box will show the folder name, file name, and ID3TAG information (Title, Artist, and Album names).
3. Equalizer
- a. The buttons listed under this menu allow the user to change the equalizer settings for the media decoder board. Please refer to the application note for additional information on the equalizer settings for this device.
4. Bass Boost
- a. This buttons listed under this menu will change the audio bass boost settings. Please refer to the application note for additional information on the equalizer settings for this device.
5. Play Mode
- a. The buttons listed under this menu allow the user to change the play mode settings of this device
 - i. ALL: this button will have the media decoder repeat all tracks
 - ii. Folder: This button will have the media decoder repeat all tracks in the current folder
 - iii. 1 File: This button will allow the media decoder to repeat the current playing song
 - iv. Random: This button will put the device into a “random” playback mode
 - v. Off: This button will turn off all repeat and random settings
6. Resume Mode
- a. The on/off buttons under the resume mode menu will allow the device to turn on/off the resume function capabilities. Please refer to the application note for additional information on the resume functionality of this device.
7. State Key
- a. The state key menu allows the user to control the general functions of the media decoder. Please see below for an explanation of the button settings.
 - i. FB Button
 - 1. While in a Play/Pause state, this button will shift to the previous tune and play it.

2. If this button is pressed for 1 second or more, the device will begin playing in a “fast backward” state
- ii. Play/Pause Button
 1. While in a stopped/paused state, this button will begin playing the audio from the specified memory. While stopped, the audio decoder will playback the first file in memory.
 2. While in a play state, this button will pause the playback of the current track.
 - iii. Stop Button
 1. This button will stop the decoder’s access to USB/SD memory and will stop playback
 2. VOL+, VOL-, PLAY, DEV_CHG, REPEAT, RANDOM buttons are ineffective while the device is stopped
 - iv. FF Button
 1. While in a Play/Pause state, this button will shift to the previous tune and play it.
 2. If this button is pressed for 1 second or more, the device will begin playing in a “fast forward” state
 - v. FOL- Button
 1. While in a Play/Pause state, this button will shift to the first file of the previous folder and play it.
 - vi. FOL+ Button
 1. While in a Play/Pause state, this button will shift to the first file of the next folder and play it.
 - vii. +10 Button
 1. While in a Play/Pause state, this button will shift forward to the tenth file away from the current playing file.
 - viii. -10 Button
 1. While in a Play/Pause state, this button will shift backwards to the tenth file away from the current playing file.

8. Trick Play Speed
 - a. This menu controls the speed of the “fast forward” and “fast backward” playback of the FF and FB Buttons
 - b. Settings to the right are faster than the settings on the left
9. Play Volume
 - a. The buttons listed under this menu allow the user to change the playback volume settings of the host media decoder IC
10. Trick Play Volume
 - a. The buttons listed under this menu allow the user to change the volume of playback when using the “fast forward” and “fast backward” playback of the FF and FB Buttons.

Appendix A. Connecting to the “USB-to-I2C Cypress Controller Board”

In order to properly use the “UHAP.exe” software GUI interface, please download and install the following:

1. .NET Framework
 - a. Please download version 2.0 or subsequent from the Microsoft homepage
2. EzUSB FX2 Development Kit
 - a. If you are having trouble connecting the BU94603 evaluation board to the computer using the provided drivers, please download the “cy361_ez_usb_fx2_development_kit_15.zip” from Cypress’s Website
 - b. <http://www.cypress.com/?rID=14319>

Appendix B. “UHAP.exe” GUI functions to I2C register command map

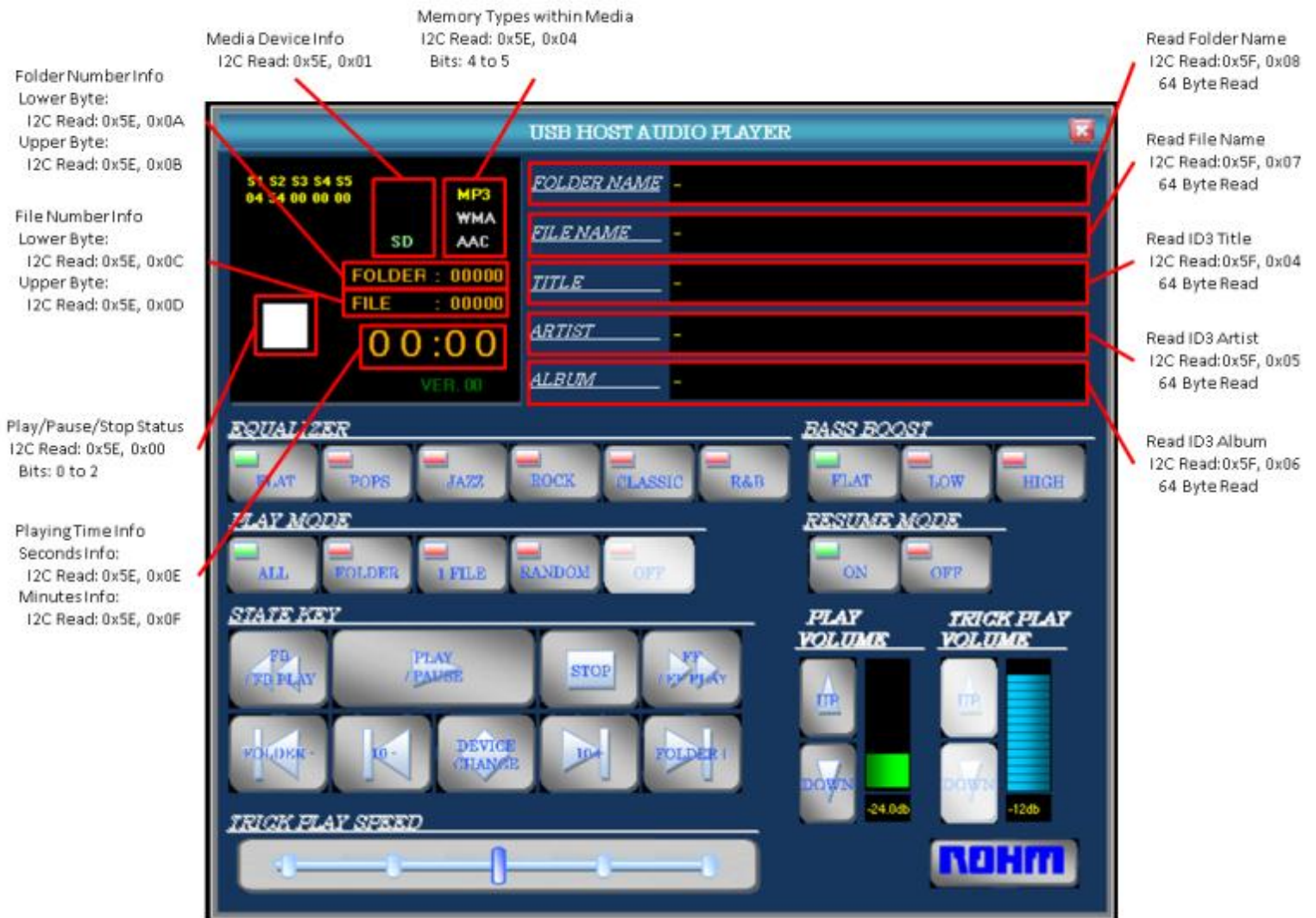

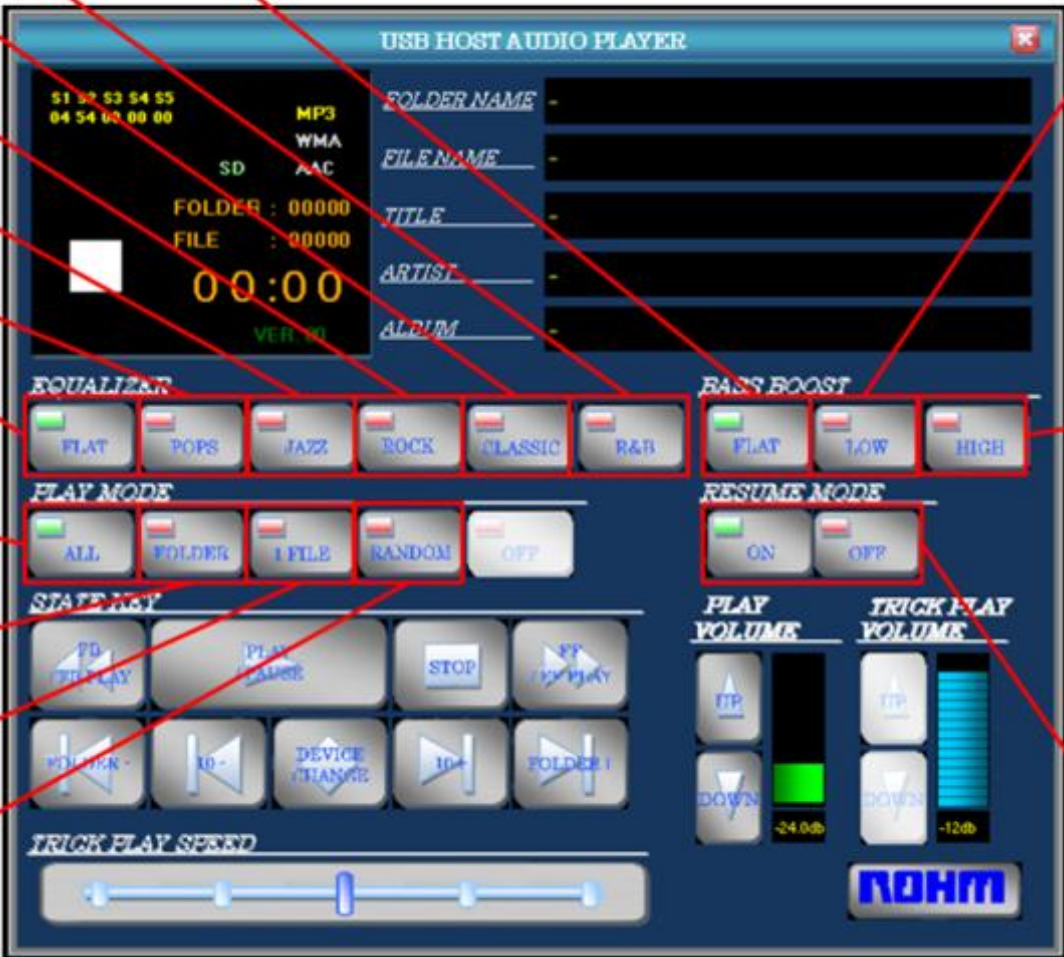

SET_EQ - CLASSIC
I2C Write: 0x52, 0x04

SET_EQ - CLASSIC
I2C Write: 0x52, 0x04

SET_EQ - ROCK
I2C Write: 0x52, 0x03

SET_EQ - JAZZ
I2C Write: 0x52, 0x02

SET_EQ - POPS
I2C Write: 0x52, 0x01

SET_EQ - OFF
I2C Write: 0x52, 0x00

SET_EQ - Off
I2C Write: 0x52, 0x07

Bass Boost 1:
(Commands Depends on Equalizer Setting)
I2C Write:
FLAT: 0x52, 0x08
POPS: 0x52, 0x09
JAZZ: 0x52, 0x0A
ROCK: 0x52, 0x0B
CLASSIC: 0x52, 0x0C
R&B: 0x52, 0x0D

Bass Boost 2
I2C Write: 0x52, 0x0F

Play Mode All:
I2C Write: 0x54, 0x00

Play Mode Folder:
I2C Write: 0x54, 0x01

Play Mode 1 File:
I2C Write: 0x54, 0x02

Play Mode 1 File:
I2C Write: 0x54, 0x03

IF Resume Mode is ON,
READ_RESUME_INFO will be sent on "STOP" and SET_RESUME_INFOx commands will be sent on "PLAY"

READ_RESUME_INFO:
I2C READ: 0x5F, 0x09
Bytes Read: 42 Bytes

SET_RESUME_INFOx:
I2C Write: 0x51, 0x41-0x48

(Please Refer to the App Note/Func. Spec for additional information)

The screenshot shows the 'USB HOST AUDIO PLAYER' interface. It includes a status display with file information (MP3, WMA, AAC, SD, FOLDER: 00000, FILE: 00000, 00:00, VER. 00), a track list (S1-S5), and a metadata section (FOLDER NAME, FILE NAME, TITLE, ARTIST, ALBUM). The interface features several control sections: EQUALIZER (FLAT, POP, JAZZ, ROCK, CLASSIC, R&B), BASS BOOST (FLAT, LOW, HIGH), PLAY MODE (ALL, FOLDER, 1 FILE, RANDOM, OFF), RESUME MODE (ON, OFF), STATE MENU (PB, PLAY/PAUSE, STOP, FF, FOLDER-, 10-, DEVICE CHANGE, 10+, FOLDER+), PLAY VOLUME (UP, DOWN, -24.0db), and TRICK PLAY VOLUME (UP, DOWN, -12db). A TRICK PLAY SPEED slider is also present. The ROHM logo is in the bottom right.

I2C Write: FF&PLAY: 0x55, 0x01, 0x01, 0x00

I2C Write: Stop: 0x55, 0x03

I2C Write: Play: 0x50, 0x01 Pause: 0x50, 0x02

I2C Write: FB&PLAY 0x55, 0x02, 0x01, 0x00

I2C Write: FOL-&PLAY: 0x55, 0x04, 0x01, 0x00

I2C Write: -10: 0x55, 0x06, 0x00, 0x00

I2C Write: CHG_DEV: 0x50, 0x08

I2C Write: +10: 0x55, 0x05, 0x00, 0x00

I2C Write: FOL+&PLAY: 0x55, 0x03, 0x01, 0x00

I2C Write: UP Button: VOL+ : 0x50, 0x04
DOWN Button: VOL- : 0x50, 0x05

Appendix C. BU94603 Build of Materials (BoM)

Main PCB:

Qty (pcs/bd)	Part Designator	Comment	Supplier P/N	DK P/N	Specs	Supplier
9	C1, C2, C3, C4, C5, C9, C10, C11, C91	0.1uF	GRM188R71E104KA01D	490-1524-1-ND	CAP CER 0.1UF 25V 10% X7R 0603	Murata
4	C1A, C2A, C8, C26	10uF	GRM31CR71A106KA01L	490-3371-1-ND	CAP CER 10UF 10V 10% X7R 1206	Murata
2	C6, C7	15pF	GRM1885C1H150JA01D	490-1407-1-ND	CAP CER 15PF 5% NPO 0603	Murata
2	C12, C13	470pF	GRM1885C1H471JA01D	490-1443-1-ND	CAP CER 470PF 50V 5% NPO 0603	Murata
2	C16, C17	4.7uF	GRM188R60J475KE19D	490-3297-1-ND	CAP CER 4.7UF 6.3V 10% X5R 0603	Murata
4	C18, C20, C21, C23	1uF	GRM31MR61C105KA01L	490-1810-1-ND	CAP CER 1UF 16V 10% X5R 1206	Murata
2	C19, C22	0.01uF	GRM188R71H123KA01D	490-1513-1-ND	CAP CER 0.012UF 50V 10% X7R 0603	Murata
2	C24, C92	100uF	C4532Y5V1A107Z	445-1414-1-ND	CAP CER 100UF 10V Y5V 1812	TDK
2	C27, C28	4.7uF	TCFGP1A475M8R	511-1491-2-ND	CAP TANT 4.7UF 10V 20% 0805	ROHM
1	C90	1uF	GRM185R61A105KE36D	490-3893-1-ND	CAP CER 1UF 10V 10% X5R 0603	Murata
1	C93	10uF	TCFGP0J106M	511-1488-2-ND	CAP TANT 10UF 6.3V 20% 0805	ROHM
2	C95, C96	100uF	TCFGB0J107M8R	511-1658-2-ND	CAP TANT 100UF 6.3V 20% 1411	ROHM
1	CN1	USB	292303-6	292303-6-ND	CONN USB TYPE A R/A PCB	TE Conn
1	CN2	SD	2041021-4	A101492CT-ND	CONN SD CARD PUSH PULL SMD	TE Conn
1	CN3	Header 10pins, 2 rows	826925-5	A106480-ND	CONN HEADER BRK WY 10POS TIN T/H	TE Conn
1	IC1	MP3 Decoder	BU94603KV	BU9458KV-E2TR-ND	IC DECODER USB HOST AUDIO 64LQFP	ROHM
1	IC2	LDO 3.3V	BH33MA3WHFV	BH33MA3WHFVTR-ND	IC REG LDO 3.3V .3A 6HVS0F	ROHM
1	IC9	HP Amp	BH4453F	BH4453F-E2-ND	HEADPHONE AMP FOR CD PLAYER	ROHM
1	L1A	1uH	B82462G4102M	495-1985-1-ND	INDUCTOR POWER 1.0UH 3.4A SMD	EPCOS
1	LED1	LED_ERROR_red		511-1301-2-ND	LED 650NM RED WTR CLR 0603 SMD	ROHM
1	LED2	LED_PLAY_green	SML-310MT	511-1299-2-ND	LED 570NM GREEN WTR CLR 0603 SMD	ROHM
5	LED3/4/5/6/7	LED_PSD/PUSB/ACCESS/RAN/REP_yellow	SML-310YT	511-1302-2-ND	LED 585NM YLW WTR CLR 0603 SMD	ROHM
1	R1	12kΩ	MCR03EZPF123	RHM12.0KHCT-ND	RES 12.0K OHM 1/10W 1% 0603 SMD	ROHM
1	R1A	2.2Ω	MCR03EZPJ2R2	RHM2.2GTR-	RES 2.2 OHM 1/10W	ROH

				ND	5% 0603 SMD	M
1	R2	1MΩ	MCR03EZPJ105	RHM1.0MGT R-ND	RES 1.0M OHM 1/10W 5% 0603 SMD	ROHM
8	R3, R11, R12, R13, R14, R15, R16, R17	220Ω	MCR03EZPJ221	RHM220GTR -ND	RES 220 OHM 1/10W 5% 0603 SMD	ROHM
2	R4, R5	2.2KΩ	MCR03EZPJ222	RHM2.2KGT R-ND	RES 2.2K OHM 1/10W 5% 0603 SMD	ROHM
1	R18	10kΩ	MCR03EZPJ103	RHM10KGTR -ND	RES 10K OHM 1/10W 5% 0603 SMD	ROHM
1	R19	4.7Ω	RK73BIJT4R 7J	P4.7GCT-ND	RES 4.7 OHM 1/10W 5% 0603 SMD	ROHM
4	R20, R21, R23, R99	0Ω	MCR03EZPJ000	RHM0.0GTR- ND	RES 0.0 OHM 1/10W 0603 SMD	ROHM
6	R22, R24, R25, R80, R81, R82	100kΩ	MCR03EZPJ104	RHM100KGT R-ND	RES 100K OHM 1/10W 5% 0603 SMD	ROHM
2	R90/R91	1kΩ	MCR03EZPJ102	RHM1.0KGT R-ND	RES 1.0K OHM 1/10W 5% 0603 SMD	ROHM
2	R92/R98	33kΩ	MCR03EZPJ333	RHM33KGTR -ND	RES 33K OHM 1/10W 5% 0603 SMD	ROHM
2	R93/R95	4.7kΩ	MCR03EZPJ472	RHM4.7KGT R-ND	RES 4.7K OHM 1/10W 5% 0603 SMD	ROHM
1	R94	75kΩ	MCR03EZPJ753	RHM75KGTR -ND	RES 75K OHM 1/10W 5% 0603 SMD	ROHM
1	R96	47kΩ	MCR03EZPJ473	RHM47KGTR -ND	RES 47K OHM 1/10W 5% 0603 SMD	ROHM
1	R97	180kΩ	MCR03EZPJ184	RHM180KGT R-ND	RES 180K OHM 1/10W 5% 0603 SMD	ROHM
14	SW1-14		MJTP1243	679-2452- ND	SWITCH TACTILE SPST- NO 0.05A 12V	APEM
2	SW13/SW14		A6T-4101	450-1358- ND	SWITCH DIP FLUSH ACT 4POS	OMRON
1	X1	16.9344MHZ	NX8045GB- 16.934400MHZ	644-1024-1- ND	CRYSTAL 16.934400 MHZ 8PF SMD	NDK
1	J1	JACK_DC	MJ-179P	NEWARK ORDER	DC Jack	秋月電子
1	J2	H.P OUT	HSJ1715-01- 110	RS COMP	HP Socket	HOSIDEN

USB FX2 PCB:

Qty (pcs/bd)	Part Designator	Comment	Supplier P/N	DK P/N	Specs	Supplier
1	U1	USB IC	CY7C68013A-56PVXC	428-1627-ND	IC MCU USB PERIPH HI SPD 56SSOP	CYPRESS
1	U3	LDO 3.3V	LM3940IMP-3.3/NOPB	LM3940IMP-3.3CT-ND	IC REGULATOR LDO 3.3V SOT-223	NATIONAL
1	X1	Crystal 24MHz	ECS-240-12-4X	XC1005-ND	CRYSTAL 24.00 MHZ 12PF HC-49/US	ECS
1	U2	mini USB	UX60A-MB-	H2961CT-ND	CONN RECEIPT MINI	HIROS

		connector	5ST		USB2.0 5POS	E
1	C1	1uF	0603ZG105ZA T2A	478-1265-1- ND	CAP CERM 1UF 10V Y5V 0603	AVX
2	C2, C5	47uF	F930J476MBA	493-2348-1- ND	CAP TANTALUM 47UF 6.3V 20% SMD	NICHI CON
2	C3, C4	12pF	CC0603JRNPO 9BN120	311-1059-1- ND	CAP CERAMIC 12PF 50V 0603 SMD	YAGE O
1	C6	0.1uF	CC0603KRX7R 7BB104	311-1088-1- ND	CAP CERAMIC 0.1UF 16V 10% X7R 0603	YAGE O
2	R1, R2	100k	ERJ- 6GEYJ104V	P100KACT- ND	RES 100K OHM 1/8W 1% 0805 SMD	PANA
2	R3, R4	2.2k	MCR10EZH2 201	RHM2.20KCC T-ND	RES 2.20K OHM 1/8W 1% 0805 SMD	ROH M
1	CN	10pos Connector	1658621-1	AKC10H-ND	CONN IDC SKT 10 POS W/POL 15GOLD	TE CONN

Appendix D. BU94603 Eval board Schematic Overview

