

注記
NOTES

- △ 偶数極品に適用。
APPLIES ONLY TO EVEN NO. CKT. SIZES.
- 2. 嵌合相手：51103 シリーズ
MATES WITH : 51103 SERIES.
- △ 3極以上のキンク形状は両サイドが(A)、その他の極はすべて(B)形状とする。
KINK FORM
MORE THAN 2 CIRCUIT:
PINS AT BOTH ENDS ARE KINK FORMED TO (A),
THE OTHER PINS ARE KINK FORMED TO (B).
- 4. 製品番号の下1桁は色を表します。
LAST DIGIT OF PART NUMBER INDICATES COLOR.
0: 白 WHITE 1: 黒 BLACK 2: 赤 RED
3: 黄 YELLOW 4: 青 BLUE
- 5. 材料 ウエハー: PBTP(15%G.F.), UL94V-0
WEFER
ピン: リン青銅 錫メッキ 1.0μm以上
下地銅メッキ 0.5μm以上
PIN: PHOSPHOR BRONZE,
TIN 1.0 micrometer MINMUM
OVER COPPER 0.5 micrometer MINIMUM
PLATING.

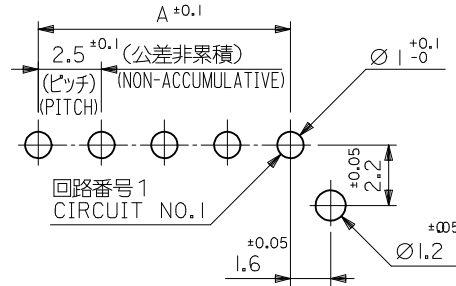
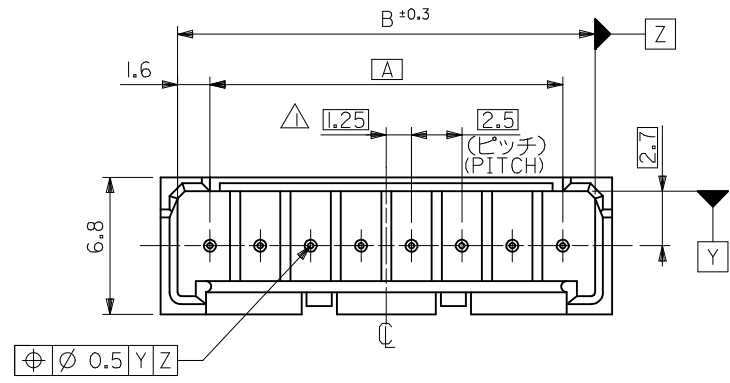

回路番号1
CIRCUIT NO.1

基板取付穴推奨寸法 (マウント面)
RECOMMENDED P.C.BOARD HOLE DIMENSION
(MOUNTING SIDE)
($t=1.6$) (SCALE 5 : 1)

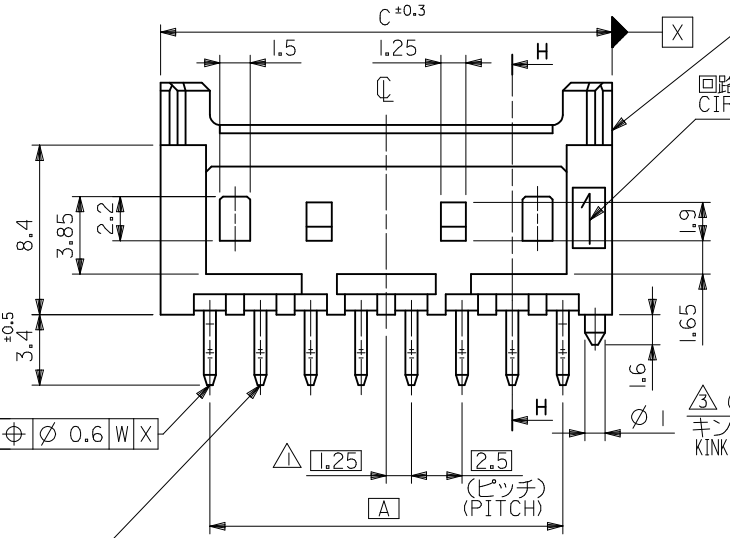

ウエハー
WAFER
PBTP(15%G.F.),UL94V-0

回路番号1
CIRCUIT NO.1

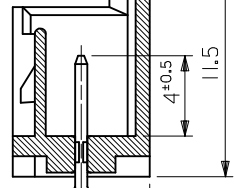

断面 H-H
SECT. H-H

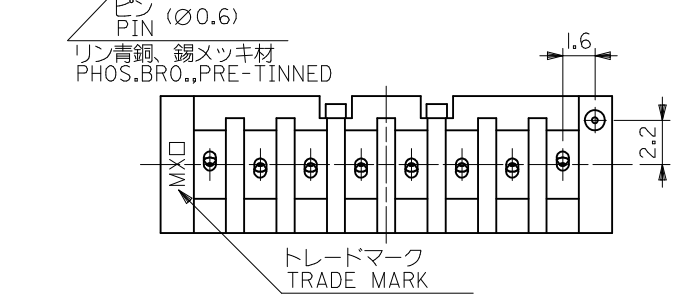
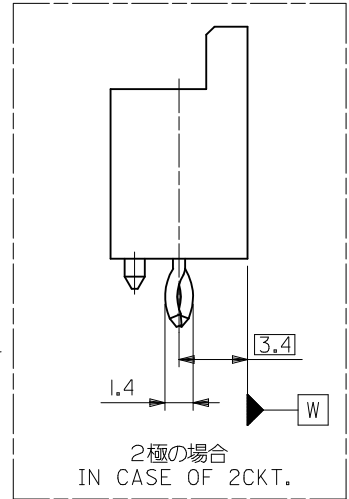

トレードマーク
TRADE MARK

39.9	38.2	35	53375-15 *	15
37.4	35.7	32.5	↑ -14 *	14
34.9	33.2	30	-13 *	13
32.4	30.7	27.5	-12 *	12
29.9	28.2	25	-11 *	11
27.4	25.7	22.5	-10 *	10
24.9	23.2	20	-09 *	9
22.4	20.7	17.5	-08 *	8
19.9	18.2	15	-07 *	7
17.4	15.7	12.5	-06 *	6
14.9	13.2	10	-05 *	5
12.4	10.7	7.5	-04 *	4
9.9	8.2	5	-03 *	3
7.4	5.7	2.5	53375-02 *	2
C	B	A	POLY BAG PACKAGE ORDER NO. MODEL NO. 53375-xx *	極数 NO. OF CKTS.

REVISED EC NO: J2013-1080 2013/04/01 DRWNR:HORI 2013/04/01 CHKD:KASAKAWA 2013/04/01 APPR:Y010 2013/04/01	DESCRIPTION REV	GENERAL TOLERANCES (UNLESS SPECIFIED)		DIMENSION STYLE MM ONLY		SCALE 4:1	DESIGN UNITS METRIC	THIRD ANGLE PROJECTION		
		10 UNDER	±0.2	DRAWN BY K. TOJO	DATE 1992/05/06	TITLE 2.5 W/B CONN WAFER ASSY WITH KINK -LEAD FREE-				
		10 OVER 30 UNDER	±0.25	CHECKED BY H. HIRAMOTO	DATE 1994/03/08					
		30 OVER	±0.3	APPROVED BY M. FUKUSUMA	DATE 1994/03/08					
ANGULAR ±3 °		DRAFT WHERE APPLICABLE MUST REMAIN WITHIN DIMENSIONS		MATERIAL NO. SEE TABLE		DOCUMENT NO. SD-53375-001		SHEET NO. 1 OF 2		
SIZE A3 THIS DRAWING CONTAINS INFORMATION THAT IS PROPRIETARY TO MOLEX INCORPORATED AND SHOULD NOT BE USED WITHOUT WRITTEN PERMISSION										

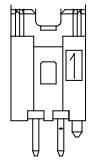

2極
2 CKT.

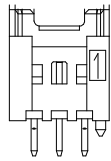

3極
3 CKT.

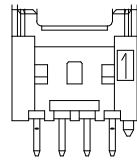

4極
4 CKT.

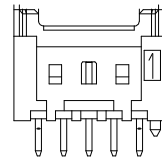

5極
5 CKT.

ロック形状図
LOCK CONFIGURATION

53375-1514	53375-1513		53375-1510	15
			53375-1410	14
			53375-1310	13
53375-1214	53375-1213		53375-1210	12
			53375-1110	11
			53375-1010	10
			53375-0910	9
53375-0814		53375-0812	53375-0810	8
		53375-0712	53375-0710	7
53375-0614	53375-0613	53375-0612	53375-0610	6
		53375-0512	53375-0510	5
			53375-0410	4
			53375-0310	3
53375-0214	53375-0213	53375-0212	53375-0210	2
53375-**14 COLOR : BLUE	53375-**13 COLOR : YELLOW	53375-**12 COLOR : RED	53375**10 COLOR : WHITE	CKT.
TRAY PACKAGE ORDER No.				

REVISED EC NO: J2013-1080 DRWR: HORI 2013/04/01 CHKD: KASAKAWA 2013/04/01 APPR: Y. ITO 2013/04/01	GENERAL TOLERANCES (UNLESS SPECIFIED)		DIMENSION STYLE MM ONLY		SCALE 4:1	DESIGN UNITS METRIC	THIRD ANGLE PROJECTION
	10 UNDER	±0.2	DRAWN BY K. TOJO	DATE 1992/05/06	TITLE 2.5 W/B CONN WAFER ASSY WITH KINK -LEAD FREE- molex		
	10 OVER 30 UNDER	±0.25	CHECKED BY H. HIRAMOTO	DATE 1994/03/08			
	30 OVER	±0.3	APPROVED BY M. FUKUSUMA	DATE 1994/03/08			
ANGULAR ±3 °		MATERIAL NO. SEE TABLE		DOCUMENT NO. SD-53375-001	SHEET NO. 2 OF 2		
DRAFT WHERE APPLICABLE MUST REMAIN WITHIN DIMENSIONS		THIS DRAWING CONTAINS INFORMATION THAT IS PROPRIETARY TO MOLEX INCORPORATED AND SHOULD NOT BE USED WITHOUT WRITTEN PERMISSION					