



22.5 mm DIN rail mounting TUR1 Part number 88865105



- Multi-function or mono-function
- Multi-range
- Multi-voltage
- Screw or spring terminals
- LED status indicator
- Option of connecting an external power supply to the control input
- 3-wire sensor control option

Part numbers

	Type	Functions	Timing	Output	Nominal rating	Connections	Supply voltage
88 865 105	TUR1	A - At - B - C - H - Ht - Di - D - Ac - Bw	0,1s→100h	1 changeover relay	8 A	Screw terminals	24 V DC / 24 →240 V AC
88 865 115	TAR1	A - At	0,1s→100h	1 changeover relay	8 A	Screw terminals	24 V DC / 24 →240 V AC
88 865 125	TBR1	B	0,1s→100h	1 changeover relay	8 A	Screw terminals	24 V DC / 24 →240 V AC
88 865 135	TCR1	C	0,1s→100h	1 changeover relay	8 A	Screw terminals	24 V DC / 24 →240 V AC
88 865 145	THR1	H - Ht	0,1s→100h	1 changeover relay	8 A	Screw terminals	24 V DC / 24 →240 V AC
88 865 155	TLR1	Li - L	0,1s→100h	1 changeover relay	8 A	Screw terminals	24 V DC / 24 →240 V AC
88 865 175	TQR1	Q	0,1s→100h	1 changeover relay	8 A	Screw terminals	24 V DC / 24 →240 V AC
88 865 100	TUR4	A - At - B - C - H - Ht - Di - D - Ac - Bw	0,1s→100h	1 changeover relay	8 A	Screw terminals	12 V AC / DC
88 865 103	TUR3	A - At - B - C - H - Ht - Di - D - Ac - Bw	0,1s→100h	1 changeover relay	8 A	Screw terminals	12 →240 V AC / DC
88 865 503	TURc3	A - At - B - C - H - Ht - Di - D - Ac - Bw	0,1s→100h	1 changeover relay	8 A	Spring terminals	12 →240 V AC / DC
88 865 185	TXR1	Ad - Ah - N - O - P - Pt - TL - Tt - W	0,1s→100h	1 change over relay	8 A	Screw terminals	24 V DC / 24 →240 V AC
88 865 305	TU2R1	A - At - B - C - H - Ht - Di - D - Ac - Bw	-	2 timed changeover relays	8 A	Screw terminals	24 V DC / 24 →240 V AC
88 865 215	TA2R1	A - At	0,1s→100h	2 changeover relays	8 A	Screw terminals	24 V DC / 24 →240 V AC
88 865 265	TK2R1	K	0,6s→160 s	2 change over relays	8 A	Screw terminals	24 V DC / 24 →240 V AC
88 865 300	TU2R4	A - At - B - C - H - Ht - Di - D - Ac - Bw	0,1s→100h	2 timed relays changeover relays	8 A	Screw terminals	12 V AC / DC
88 865 176	TQR6	Q : Star / Delta	0,1s→100h	1 change over relays	8 A	Screw terminals	230 V →440 V AC
88 865 303	TU2R3	A, B, C, H, Di, Ac, BW + (At, Ht, D)	0,1s→100h	2 timed changeover relays	8 A	Screw terminals	12 →230 V AC/DC
88 865 385	TX2R1	Ad - Ah - N - O - P - Pt - TL - Tt - W	0,1s→100h	2 timed changeover relays	8 A	Screw terminals	24 V DC / 24 →240 V AC

Specifications

Timing

Timing ranges (7 ranges)	1 s - 10 s - 1 min - 10 min - 1 h - 10 h - 100 h TK2R1 : 0.6s - 2.5s - 20s - 160 s
Repetition accuracy with constant parameters	± 0.5 % (IEC/EN 1812-1)
Drift Temperature	± 0,05 % / °C
Drift Voltage	± 0.2 % / V
Display accuracy according to IEC/EN 61812-1	± 10 % / 25 °C
Minimum pulse duration typically (relay version)	30 ms
Minimum pulse duration typically (solid state version)	50 ms
Minimum pulse duration typically (relay version under load)	100 ms
Maximum reset time by de-energisation typically (relay version)	100 ms
Maximum reset time by de-energisation typically (solid state version)	350 ms
Immunity from micro power cuts : typical	> 10 ms

Supply

Multi-voltage power supply	Depending on version
Frequency (Hz)	50 / 60
Operating range	85 to 110 % Un (85 to 120 % Un for 12V AC/DC)
Operator factor	100 %
Max. absorbed power	0,6 W 24 V AC/DC 1,5 W 230 V AC 32 VA 230 V AC

Output specification

1 or 2 changeover relays, AgNi (cadmium-free)	2000 VA/80 W
Rated power	2000 VA/80 W
Maximum breaking current	8 A AC 8A DC
Minimum breaking current	10 mA / 5 V DC
Voltage breaking capacity	250 V AC/ DC
Electrical life (operations)	10 ⁵ operations 8 A 250 V resistive

Mechanical life (operations)	5x10 ⁶
Breakdown voltage acc. to IEC/EN 61812-1	2.5 kV / 1 min / 1 mA / 50 Hz
Impulse voltage acc. to IEC/EN 60664-1, IEC/EN 61812-1	5 kV, wave 1.2 / 50 µs
Solid state output	
Rated power	0,7 A AC/DC 20 °C (0,5 A UL)
Derating	5 mA / °C
Maximum admissible current	20 A ≤ 10 ms
Minimum breaking current	10 mA
Leakage current	< 5 mA
Voltage breaking capacity	250 V AC/ DC
Maximum voltage drop at terminals	3 wire 4V - 2 wire 8V
Electrical life (operations)	10 ⁸
Mechanical life (operations)	10 ⁸
Breakdown voltage acc. to IEC/EN 60664-1, IEC 60255-5	2.5 kV to 1 mA / 1 min
Input type	Volt-free contact 3-wire PNP output control option residual voltage : 0.4V whatever the timer power supply

General characteristics

Conformity to standards	IEC/EN 61812-1 IEC/EN 61000-6-1 IEC/EN 61000-6-2 IEC/EN 61000-6-3 IEC/EN 61000-6-4
Certifications	CE, UL, cUL, CSA, GL
Temperature limits use (°C)	-20 → +60
Temperature limits stored (°C)	-30 → +60
Installation category (acc. to IEC/EN 60664-1)	Voltage surge category
Creepage distance and clearance acc. to IEC/EN 60664-1	4 kV / 3
Protection (IEC/EN 60529)	IP 20 IP 40
Degree of protection acc. to IEC/EN 60529 Front face (except Tk2R1)	IP 50
Vibration resistance acc. to IEC/EN 60068-2-6	f = 10 ■ 55 Hz A = 0,35 mm
Relative humidity no condensation acc. to IEC/EN 60068-2-30	93 % sans condensation
Electromagnetic compatibility - Immunity to electrostatic discharges acc to IEC/EN 61000-4-2	Level III (Air 8 KV / Contact 6 KV)
Immunity to radiated, radio-frequency, electromagnetic field acc. CEI/EN 61000-4-3	Level III 10V/m (80 M Hz to 1 G Hz)
Immunity to rapid transient bursts acc. to IEC/EN 61000-4-4	Level III (direct 2kV / Capacitive coupling clamp 1 KV)
Immunity to shock waves on power supply acc. to IEC/EN 61000-4-5	Level III (2 KV / common mode 2 KV/residual current mode 1KV)
Immunity to radio frequency in common mode acc. to IEC/EN 61000-4-6	Level III (10V rms : 0.15 M Hz to 80 M Hz)
Immunity to voltage dips and breaks acc. to IEC/EN 61000-4-11	30 %/10 ms 60 %/100 ms > 95 %/5 s
Mains-borne and radiated emissions acc. to EN 55022 (CISPR22), EN55011 (CISPR11)	Class B
Fixing : Symmetrical DIN rail	35 mm
Connection capacity - without ferrule	2 x 2,5 mm ²
Connection capacity - with ferrule	2 x 1,5 mm ²
Spring terminals, 2 terminals per connection point - flexible wire	1,5 mm ²
Spring terminals, 2 terminals per connection point - rigid wire	2,5 mm ²
Housing material	Self-extinguishing
Weight : casing 17,5 mm	60 g
Weight : casing 22,5 mm	90 g
Weight : plug-in casing	80 g

Display

State displayed by 2 LEDs

- Flashing green when on
 - Relay LED yellow during timing
- Green LED operation indicator

Pulsing :

- Timer on, no timing in process

Permanently lit :

- Relay waiting, no timing in process

Dimensions (mm)

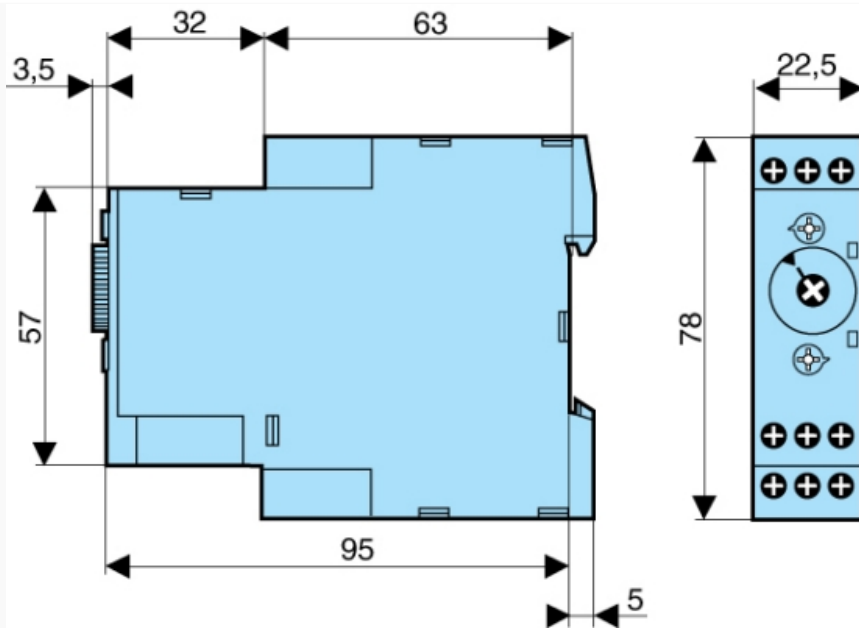

Curves

Function A - 1 relay output

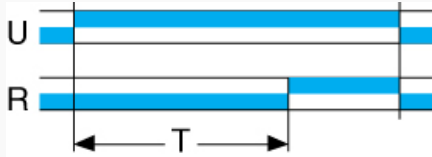

Function A

Delay on energisation

Curves

Function Ac - 1 relay output

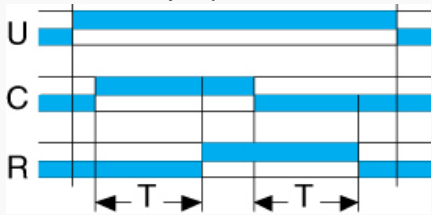

Function Ac

Timing after closing and opening of control contact

Curves

Function At - 1 relay output

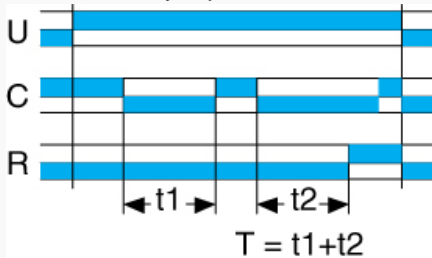

Function At

Timing on energisation with memory

Curves

Fonction B - 1 relay output

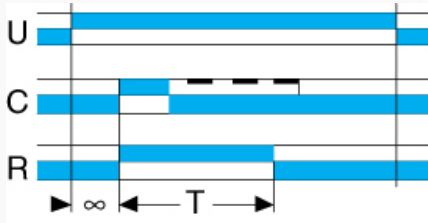

Function B

Timing on impulse one shot

Curves

Function Bw - 1 relay output

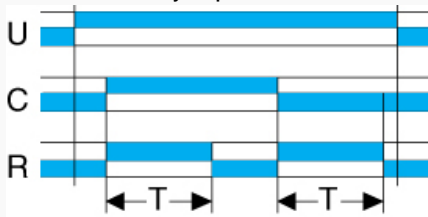

Function Bw

Pulse output (adjustable)

Curves

Function C - 1 relay output

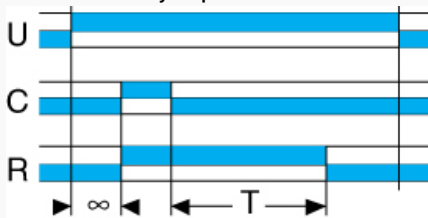

Function C

Timing after impulse

Curves

Function D - 1 relay output



Function D

Flip-flop
Pause start

Curves

Function Di - 1 relay output

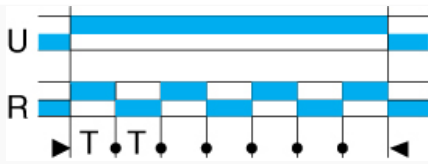

Function Di
Flip-flop Pulse start

Curves

Function H - 1 relay output

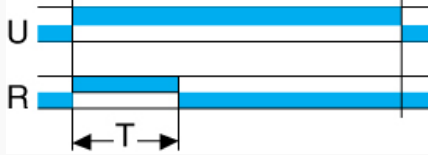

Function H
Timing on energisation

Curves

Function Ht - 1 relay output

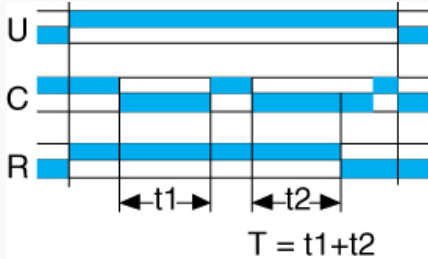

Function Ht
Delay on energisation with memory

Connections

1 changeover relay output

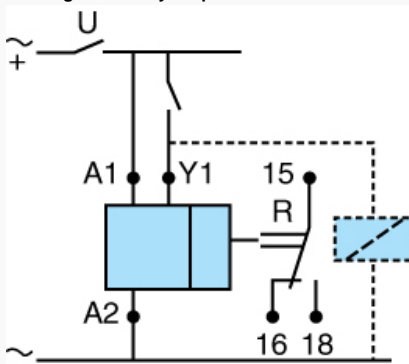

Functions
A - At - B - C - H - Ht - Di - D - Ac - Bw Ad - Ah - N - O - P - Pt - TL - Tt - W