

I/O Connector Modules

PPM3

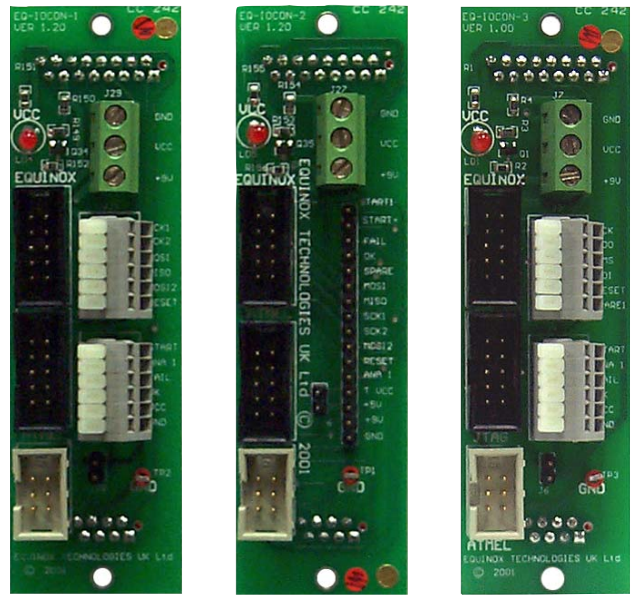

Reference Manual



The Embedded Solutions Company

Contents

Copyright Information	1
Equinox Warranty Information	2
Electromagnetic Compatibility (EMC) Compliance	3
Technical Support	4
1.0 Introduction	5
1.1 Connector Systems currently supported.....	5
1.2 Programmers supported	5
2.0 Overview of I/O Connector Modules	6
3.0 ISP Header Selection	8
3.1 Overview.....	8
3.2 ISP Header Selection Chart (by header)	8
3.3 ISP Header Selection Chart (by Device).....	10
3.4 Atmel 6-way ISP Header (SPI Interface)	12
3.5 Equinox 10-way Header (Generic SPI Interface).....	14
3.6 Equinox 10-way Header (ATtiny11/12/15 HV Interface)	16
3.7 Equinox 10-way Header (UART Boot Loader).....	18
3.8 Atmel 10-way Header (SPI Interface)	20
3.9 Atmel 10-way JTAG Header (JTAG Interface).....	22
4.0 ISP Cable considerations	24
5.0 Power Connections + Vcc Sense	27
5.1 Overview.....	27
5.2 Vcc Option Link.....	27
5.3 Target Vcc Sense LED	27
6.0 IO-CON-1 Module	28
6.1 Overview.....	28
6.2 Features.....	28
6.3 Support Device Families	28
6.4 Connector Layout Schematic.....	29
6.5 ISP Header Connectors.....	30
6.6 Clip-In Fast-Connectors	30
6.7 Power Connector – Screw terminals (J29).....	31
7.0 IO-CON-2 Module	32
7.1 Overview.....	32
7.2 Features.....	32
7.3 Device Family Support.....	32
8.0 IO-CON-3 Module (JTAG)	35
8.1 Overview.....	35
8.2 Features.....	35
8.3 Support Device Families	35
8.4 Connector Layout schematic	37
8.5 Clip-In fast Connector (J3 & J4).....	38
9.0 EQ-CALCON Module	40
9.1 Overview.....	40
9.2 Features.....	40

9.3 Supported Device Families	40
9.4 Connector Layout Schematic	41
9.5 ISP Header Connectors	42
9.6 Clip-In Fast-Connectors	42
9.7 Power Connector – Screw terminals (J29)	43

Copyright Information

Information in this document is subject to change without notice and does not represent a commitment on the part of the manufacturer. The software described in this document is furnished under license agreement or nondisclosure agreement and may be used or copied only in accordance with the terms of the agreement.

It is against the law to copy the software on any medium except as specifically allowed in the license or nondisclosure agreement.

The purchaser may make one copy of the software for backup purposes. No part of this manual may be reproduced or transmitted in any form or by any means, electronic, mechanical, including photocopying, recording, or information retrieval systems, for any purpose other than for the purchaser's personal use, without written permission.

© 2000 - 2008 Copyright Equinox Technologies UK Limited. All rights reserved.

Atmel™ and AVR™ are trademarks of the Atmel Corporation

Microsoft, MS-DOS, Windows™, Windows 95™, Windows 98™, Windows XP™ and Windows NT4™ are registered trademarks of the Microsoft Corporation

IBM, PC and PS/2 are registered trademarks of International Business Machines Corporation

Intel, MCS 51, ASM-51 and PL/M-51 are registered trademarks of the Intel Corporation

Every effort was made to ensure accuracy in this manual and to give appropriate credit to persons, companies and trademarks referenced herein.

Equinox guarantees that its products will be free from defects of material and workmanship under normal use and service, and these products will perform to current specifications in accordance with, and subject to, the Company's standard warranty which is detailed in Equinox's Purchase Order Acknowledgment.

Equinox Warranty Information

This product is guaranteed by Equinox Technologies UK Limited for a period of 12 months (1 year) after the date of purchase against defects due to faulty workmanship or materials. One guarantee covers both parts and labour. Service under the guarantee is only provided upon presentation of reasonable evidence that the date of the claim is within the guarantee period (e.g. completed registration/guarantee card or a purchase receipt).

The guarantee is not valid if the defect is due to accidental damage, misuse or neglect and in the case of alterations or repair carried out by unauthorised persons. A number of exceptions to the warranty are listed in the 'Exceptions to warranty' section below. Service (during and after guarantee period) is available in all countries where the product is distributed by Equinox Technologies UK Limited.

Exceptions to warranty

Over-voltage damage

This warranty does not cover damage to the programmer due to voltages beyond the specified voltage limits being applied to the 'DC Power Input' (CON1) or any of the ISP Headers. The user must ensure that sufficient care is taken to avoid over-voltage and static conditions on any of the 'ISP Header' I/O pins.

Over-current damage

This warranty does not cover damage to the programmer due to excessive current being drawn from the programmer power supply. The user must ensure that there is sufficient over-current protection within the test fixture to protect against short circuit loads.

Short-circuit damage

This warranty does not cover damage to the programmer due to short-circuit loads being placed across programmer I/O lines.

Warning!

Any damage caused to the programmer by Electrostatic Discharge (ESD) through inadequate earthing is not covered under the warranty of the product.

Electromagnetic Compatibility (EMC) Compliance

The '**IO-CON-1 / 2 / 3 Modules**' are CE Approved products. They are designed for use in an ESD controlled environment i.e. development or production. This means, therefore, that the user must ensure that there is no possibility of damage from electrostatic discharge (ESD). Since the devices and equipment to which this product is likely to be connected may well themselves be susceptible to ESD, this should not pose any difficulty.

For example, if you are handling microcontrollers and EEPROMS etc. then you will already be used to appropriate precautions, such as the use of anti-static mats, wrist straps and so on. You should treat your '**IO-CON Modules**' with the same care as you would these types of devices. Always ensure that you are not yourself carrying a static charge before handling the product. Wearing an earthed anti-static wrist strap is recommended.

Equinox have taken great care in designing this product to be compliant with the European EMC directive. When using the equipment be sure to follow the instructions provided. Although RF emissions are within prescribed limits, care should be taken if you are using the product near to sensitive apparatus. If you experience any difficulty please refer to Equinox Technical Support.



ESD Points to remember

- Work in a static-free environment.
- Wear an earthed wrist strap when handling either the programmer and/or any programmable device.
- Ensure that the PC, programmer and Target system are connected to the same EARTH (0V) potential.
- Do NOT plug the ISP cable of the programmer into a Target System when the Target power is ON.

Warning!

Any damage caused to the programmer by Electrostatic Discharge (ESD) through inadequate earthing is not covered under the warranty of the product.

Technical Support

It may be the case that users experience problems when installing or using a product for the first time.

If you have a technical support problem, please consult the following list for help:

➤ **Manual**

➤ **On-line help**

Press <F1> for help at any time when running EQTools or ISP-PRO.

The help system is context-sensitive. Simply press <F1> on any error message and the possible causes of the error should be listed. This help system is updated on a regular basis. Please see software update details for information on keeping up-to-date with software revisions.

➤ **Internet Web Site**

The support page for all Equinox ISP Programmers can be found at:
<http://www.equinox-tech.com/products/downloadssearch.asp>.

➤ **E-mail**

Please e-mail any technical support questions about this product to:
support@equinox-tech.com

➤ **Fax**

Please fax any technical support questions about this product to: +44 (0) 1942 844181

Equinox will try our best to answer your questions about this product as quickly as possible. However, we cannot promise an immediate reply. Please consult our web site for new software updates as the problem that you are enquiring about may have already been fixed in a new version.

1.0 Introduction

Equinox has developed a range of plug-in user-replaceable 'I/O Connector Modules' which are designed to interface the Equinox 'PPM3 Programming Module' to a variety of different Target Systems. This plug-in approach allows the required connection system to be tailored to a particular Target System or Test Fixture without the requirement for unwiring the Test Fixture.

The currently available 'I/O Connector Modules' are as follows:

- EQ-IOCON-1
- EQ-IOCON-2
- EQ-IOCON-3
- EQ-CALCON

Features:

- Plug-in 'I/O Connector Modules' – simply plugs into the mating sockets on the PPM3 Module
- Different connector methods for interfacing to the Target System can be implemented by simply plugging in the relevant 'I/O Connector Module'.
- Programmer or Test Fixture can be easily swapped out without the requirement for unwiring the Test Fixture
- One programmer can easily be used with multiple Test Fixtures
- New connection systems can be implemented using a new 'I/O Connector Module' without requiring any redesign of the PPM3 Module.
- IO-CON-2 Module supports 'wire-wrap' connections
- IO-CON-1 / -2 support clip-in wire 'Fast Connect' wiring system
- EQ-CALCON Module provides a 32kHz oscillator under programmer control
- Target Vcc LED - illuminates when the 'Target Vcc' is detected
- Auxiliary Power available via screw-terminal connections

1.1 Connector Systems currently supported

The following ISP connector systems are currently supported

- Atmel 10-way ISP Header (SPI)
- Atmel 6-way ISP Header (SPI)
- Atmel 10-way ISP Header (JTAG)
- Equinox 10-way ISP Header for Atmel T89C51Rx2 microcontrollers
- Equinox 10-way ISP Header for Philips P89C51Rx2 and P89C66x microcontrollers
- Wire-wrap (all devices)
- Fast-Connect - plug-in wired connectors (all devices)
- 24Cxxx Serial EEPROM programming via I2C Interface is supported on all ISP Headers

1.2 Programmers supported

The I/O Connector Modules are compatible with the following Equinox programmers:

- PPM3 MK1 – Production ISP Module Version 1
- PPM3 MK2 – Production ISP Module Version 2

2.0 Overview of I/O Connector Modules

There are currently four different I/O Connector Modules available as detailed in the table below:

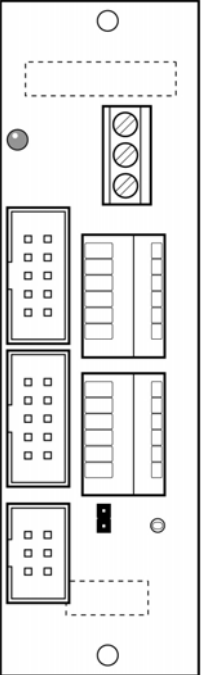
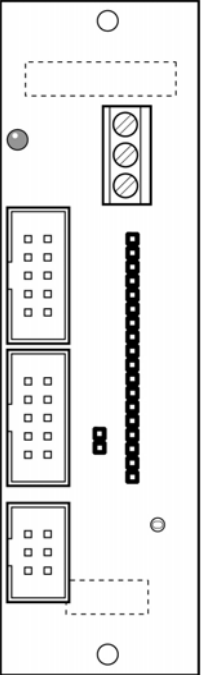
Order Code	Description
<p>EQ-IOCON-1</p>  <p>The diagram shows a rectangular PCB with various connectors. At the top, there is a circular hole. Below it, a dashed rectangle indicates a specific area. On the left side, there are three multi-pin headers. On the right side, there are two multi-pin headers and a small LED. At the bottom, there is another circular hole and a small component.</p>	<p>I/O Connector Module 1 (SPI) – Fast Connect Version</p> <p>I/O connector module for In-System Programming (ISP) of Atmel microcontrollers using SPI protocol (Fast Connect version)</p> <p>This module plugs into the PPM3 and provides the relevant I/O connectors for SPI programming of Atmel devices.</p> <p>Features:</p> <ul style="list-style-type: none"> • Plugs into suitable Equinox programmer eg. PPM3 Module • Atmel 10-way IDC ISP Header • Atmel 6-way IDC ISP Header • Equinox 10-way IDC ISP header • 'Fast Connect' clip-in connectors for direct wiring to Test Fixture i.e wires from bed-of-nails probe wires • Screw terminals for power connections • Target Vcc Status LED • Link to connect / isolate the programmer Vcc from the Target Vcc
<p>EQ-IOCON-2</p>  <p>The diagram shows a rectangular PCB similar to EQ-IOCON-1. It has a circular hole at the top and another at the bottom. On the left side, there are three multi-pin headers. On the right side, there is a long single-in-line header and a small LED. A dashed rectangle is also present at the top.</p>	<p>I/O Connector Module 2 (SPI) – Wire-wrap version</p> <p>I/O connector module for In-System Programming (ISP) of Atmel microcontrollers using SPI protocol (wire-wrap version)</p> <p>Features:</p> <ul style="list-style-type: none"> • Plugs into suitable Equinox programmer e.g. PPM3 Module • Atmel 10-way IDC ISP Header • Atmel 6-way IDC ISP Header • Equinox 10-way IDC ISP header • Single-in-line header with all programmer I/O brought out for wire-wrapping to bed-of-nails probe wires • Screw terminals for power connections • Target Vcc Status LED • Link to connect / isolate the programmer Vcc from the Target Vcc

EQ-IOCON-3

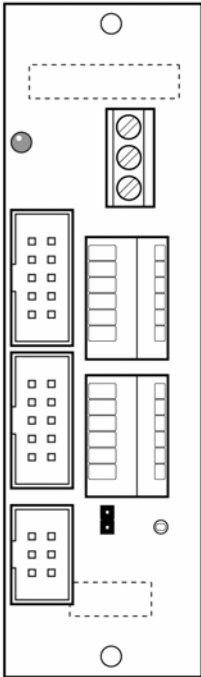

I/O Connector Module 3 (JTAG) – Fast Connect Version

I/O connector module for In-System Programming (ISP) of Atmel microcontrollers using JTAG protocol

Features:

- Plugs into suitable Equinox programmer e.g. PPM3 Module
- Atmel 10-way JTAG IDC ISP connector (same as JTAG-ICE)
- Atmel 6-way IDC ISP Header
- Equinox 10-way IDC ISP header
- Single-in-line header with all programmer I/O brought out for wire-wrapping to bed-of-nails probe wires
- Screw terminals for power connections
- Target Vcc Status LED
- Link to connect / isolate the programmer Vcc from the Target Vcc

Please note

The 'Atmel AVR JTAG License' (Order code: PPM3A1-UPG7) is also required to enable the PPM3 to program Atmel AVR devices via JTAG.

EQ-CALCON

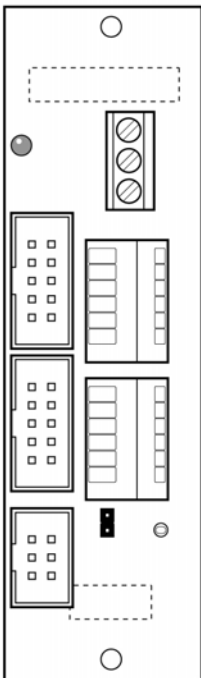

EQ-CALCON Module

The EQ-CALCON Module is a special plug-in I/O Connector Module for the PPM3-MK2 programmer which is used to facilitate very accurate calibration of the Internal Oscillator of an Atmel ATmega or ATtiny AVR microcontroller. The module features an on-board high accuracy 32kHz Oscillator Module which can be connected to the target AVR microcontroller MOSI pin during the Oscillator Calibration Procedure as described in the Atmel Application Note 'AVR053: Calibration of the Internal Oscillator'.

Features:

- Plugs into suitable Equinox programmer e.g. PPM3 Module
- Atmel 10-way JTAG IDC ISP connector (same as JTAG-ICE)
- Atmel 6-way IDC ISP Header
- Equinox 10-way IDC ISP header
- Screw terminals for power connections
- Target Vcc Status LED
- Link to connect / isolate the programmer Vcc from the Target Vcc

Please note

The use of this module requires development of / purchase of suitable 'Calibration Firmware' for the chosen ATmega AVR microcontroller.

3.0 ISP Header Selection

3.1 Overview

The method of connection to the Target System or Test Fixture is usually dictated by the interconnect method already used on the Target System or Test Fixture. If the programmer is to be interfaced directly to a header on a Target System, then it is likely that one of the 6-wy or 10-way ISP box headers will be used. If, however, the programmer is to be interfaced to a Test Fixture, then 'Wire-wrap' or 'Fast Connect' clip-in connects are more likely to be used.

The choice of possible headers and connection systems are detailed in section 3.1.

The available headers for a particular device manufacturer / device type are detailed in section 3.2.

3.2 ISP Header Selection Chart (by header)

The various ISP Headers featured on the EQ-IO-CON modules are detailed in the table below. Please refer to the section indicated in the 'refer to section' column for specific details of each header.

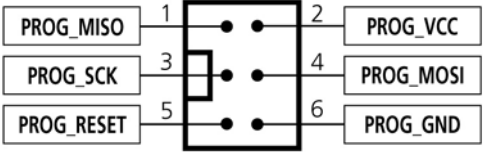
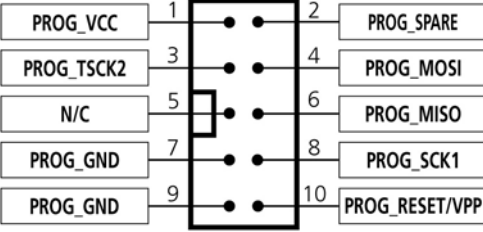
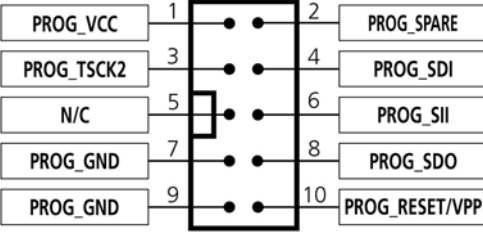
#	I/O Connector Module	Description / Function	Refer to section	ISP Header Pin-out
1	IOCON-1 IOCON-2 IOCON-3	Atmel 6-way ISP Header Device support: <ul style="list-style-type: none"> Atmel AT90S, ATmega, ATtiny AVR microcontroller AT89S microcontrollers 24Cxxx Serial EEPROM 	3.4	
<p>The 'Equinox' Header can have THREE different pin-outs depending on which Target Device is to be programmed. See (2a), (2b) and (2c).</p>				
2a	IOCON-1 IOCON-2 IOCON-3	Equinox 10-way Header(a) Device support: Atmel AT90S, ATmega, ATtiny, AT89S devices	3.5	
2b	IOCON-1 IOCON-2 IOCON-3	Equinox 10-way Header(a) Device support: Atmel ATtiny11/12/15 High Voltage (+12V Vpp) Programming Mode	3.6	

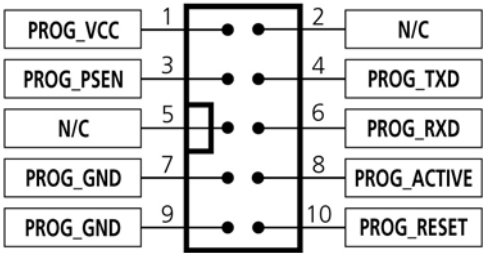
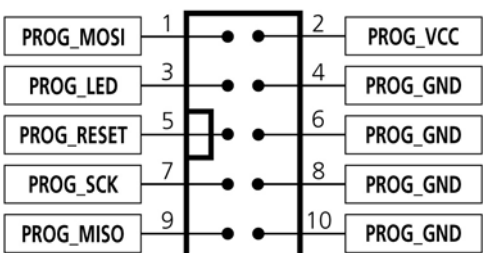
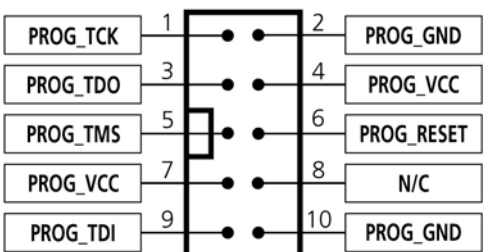
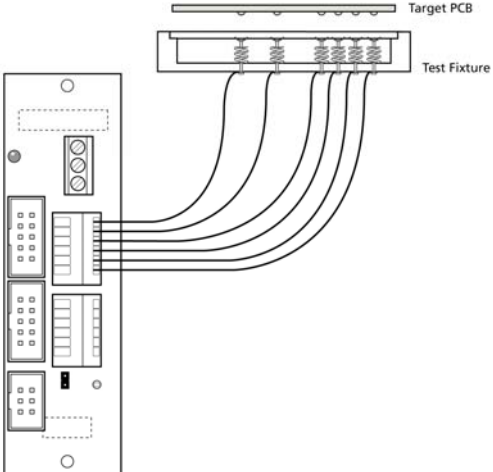
2c	IOCON-1 IOCON-2 IOCON-3	Equinox 10-way Header(b) Device support: Atmel Wireless T89C51Rx2 Philips P89C51Rx2 / 66x	3.7	
3	IOCON-1 IOCON-2	Atmel 10-way Header Device support: Atmel AT90S, ATmega, ATtiny, AT89S devices	3.8	
4	IOCON-3	Atmel 10-way JTAG Header Device support: Atmel ATmega microcontrollers with JTAG port	3.9	
5	IOCON-2	Wire-wrap connections Device support - All		
6	IOCON-1 IOCON-2	Fast-Connect headers Device support – All Please refer to relevant I/O- CON section for further details about the 'Fast-Connect' headers.		

3.3 ISP Header Selection Chart (by Device)

The table below details which header to choose for a specified device or device family. The information contained in this manual does NOT show the actual connections to the Target Microcontroller. Please refer to the separate Application Notes (see App Note column in table below) for full details of how to implement In-System Programming for your selected device.

Please note:

- The Atmel ATmega16 / 32 / 64 / 323 / 128 / 169 devices can be programmed via ‘LV SPI’ or ‘JTAG’ by connecting the relevant header to the SPI or JTAG port of the device.
- The so-called ‘Equinox Header’ is multi-functional. The pin-out of this header is different depending on which device type is being programmed.

#	Device Family	Devices	Algorithm	Required IO-CON Module + ISP Header
1	Atmel AT89S	AT89(L)S51/52/53/8252	LV SPI	IOCON-1 <ul style="list-style-type: none"> • Equinox 10-way header • Atmel 10-way header • Atmel 6-way header • Fast-Connect header IOCON-2 <ul style="list-style-type: none"> • Equinox 10-way header • Atmel 10-way header • Atmel 6-way header • Wire-wrap header (J25) IOCON-3 <ul style="list-style-type: none"> • Equinox 10-way header • Atmel 10-way header • Atmel 6-way header • Fast-Connect header
2	Atmel AT90S (AVR)	All AT90S ISP devices	LV SPI	Same as (1)
3	Atmel ATmega (AVR)	All ATmega devices (using SPI port for programming)	LV SPI	Same as (1) Use IO-CON-3 if JTAG support is also required.
4	Atmel ATmega (AVR)	ATmega with JTAG port for programming	JTAG	IOCON-3 <ul style="list-style-type: none"> • JTAG 10-way header • Fast Connect Headers (J3 & J4) • The Equinox 10-way header on this module can be used for SPI programming.

5	Atmel ATtiny (Low Voltage)	All ATtiny ISP devices	LV SPI	Same as (1)
6	Atmel ATtiny (High Voltage)	ATtiny11/12/15L	HV SPI	IO-CON-1 <ul style="list-style-type: none"> Equinox 10-way header IO-CON-2 <ul style="list-style-type: none"> Equinox 10-way header IO-CON-3 <ul style="list-style-type: none"> Equinox 10-way header
7	Atmel W&uC (Temic) T89C51Rx2	T89CRB2/RC2/RD2	UART Boot Loader	Same as (6)
8	Philips P89C51Rx2	P89CRB2/RC2/RD2	UART Boot Loader	Same as (6)
9	Philips P89C66x	P89C662/4/8	UART Boot Loader	Same as (6)
10	24Cxxx	24Cxxx Serial EEPROM Memory Devices	I2C	The 24Cxxx devices can be programmed using any connector on any I/O Connector Module: <ul style="list-style-type: none"> IO-CON-1 IO-CON-2 IO-CON-3

3.4 Atmel 6-way ISP Header (SPI Interface)

This connection method is suitable for interfacing the programmer to a Target System which features the following:

- Atmel 6-way IDC ISP Header
- An Atmel device which features the 3-wire SPI + RESET Programming Interface

The 6-way IDC box header is the most compact header i.e. takes up least space on the Target System and so is very popular for designs where PCB space is limited. Unfortunately, this connection method does not have any pins spare for extra functionality such as the SCK2 Oscillator so it should only be used if this functionality is not required.

To implement this connection method, simply plug a 6-way ISP cable (not supplied) into the 6-way ISP header and plug the other end of the cable into the matching header on the Target System.

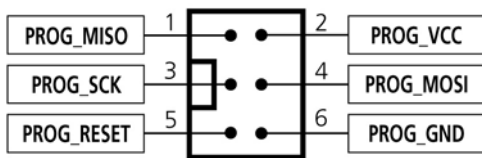

Figure 4.4.1 - Atmel 6-way IDC Header (J3) viewed from above

Warning!

Connecting to the wrong ISP Header may cause catastrophic damage to the Programmer & Target System

Pin No	Programmer Pin name	Programmer Input / Output	Connect to pin on Target Device	Description
1	PROG_MISO	I	MISO (except for ATmega103/128/64 – connect to TXD pin instead)	Master In Slave Out This is the SPI data input pin to the programmer. This pin should be connected to the MISO pin on the Target Microcontroller.
2	PROG_VCC	P	TARGET_VCC	Target Vcc This pin should be connected to the Target System Vcc. This voltage could be used to power the programmer depending on the settings of the power switch/jumper on the programmer.
3	PROG_SCK1	O	SCK	SPI Serial Clock Output This is the SPI clock output signal.
4	PROG_MOSI	O	MOSI (except for ATmega103/128/64 – connect to RXD pin instead)	Master Out Slave In This is the SPI data output pin from the programmer. This pin should be connected to the MOSI pin on the Target Microcontroller.

5	PROG_RESET	O	RESET	Target RESET control pin This pin controls the Target Device RESET pin. It will driven HIGH/LOW according to the device type and settings in the 'Pre-program State Machine' tab in the Eqtools project.
6	PROG_GND	P	GROUND	Ground Connection Common ground connection between PROGRAMMER and Target System.

Key

O - Output from programmer to Target Device

I - Input to programmer from Target Device

P - Passive e.g. GROUND and power rails

N/C - Not connected

3.5 Equinox 10-way Header (Generic SPI Interface)

This connection method is suitable for interfacing the programmer to a Target System which features the following:

- Equinox 10-way IDC ISP Header
- An Atmel device which features the 3-wire SPI + RESET Programming Interface

This is the favoured ISP connector as it allows the following additional functions:

- Application of +12V Vpp for ATtiny High Voltage Serial Programming
- SCK2 Oscillator for clocking devices during programming
- Spare I/O pin which could be used for SPI SLAVE SELECT or to drive an LED on the Target System

To implement this connection, simply plug the 10-way ISP cable into the header marked 'Equinox' and plug the other end of the cable into the matching header on the Target System.

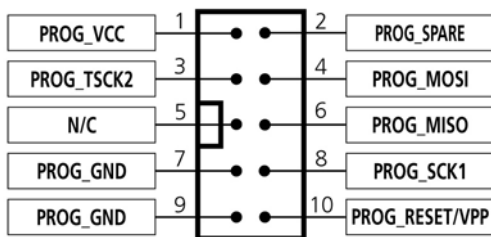

Figure 4.5.1 – Equinox 10-way IDC Header (J8) viewed from above

Warning!

1. It is possible for +12V to be output on pin 10 of this connector when programming ATtiny11/12/15 devices.
2. Connecting to the wrong ISP Header may cause catastrophic damage to the Programmer & Target System

Pin No	Programmer Pin name	Programmer Input / Output	Connect to pin on Target Device	Description
1	PROG_VCC	P	TARGET_VCC	Target VCC This pin should be connected to the Target System Vcc. This voltage could be used to power the programmer depending on the settings of the power switch/jumper on the programmer.
2	PROG_SPARE	-	No connect	Spare Programmer I/O pin This pin is currently a spare I/O pin which is not used during SPI programming. In order to use this pin, the pin state must be setup in the EQTools <Pre-programming State Machine> tab.

3	PROG_TSCK2	O	XTAL1 Only connect this pin if you are using the SCK2 Clock Output to clock the Target Device during programming !	SCK2 Clock Output (*Optional*) This output signal can be used to supply an external clock signal (SCK2) to the target microcontroller. This function must be enabled in the EQTools <Pre-programming State Machine> tab. If the SCK2 oscillator is not being used, then the pin could be used as a spare output pin.
4	PROG_MOSI	O	MOSI (except for ATmega103/128/64 – connect to RXD pin instead)	Master Out Slave In This is the SPI data output pin from the programmer. This pin should be connected to the MOSI pin on the Target Microcontroller.
5	N/C	O	N/C	Not connected
6	PROG_MISO	I	MISO (except for ATmega103/128/64 – connect to TXD pin instead)	Master In Slave Out This is the SPI data input pin to the programmer. This pin should be connected to the MISO pin on the Target Microcontroller.
7	PROG_GND	P	GROUND	Ground Connection Common ground connection between PROGRAMMER and Target System.
8	PROG_SCK1	O	SCK	SPI Serial Clock Output This is the SPI clock output signal used to clock data into / out of the Target Device.
9	PROG_GND	P	GROUND	Ground Connection Common ground connection between PROGRAMMER and Target System.
10	PROG_RESET	O	RESET	Target RESET control pin This pin controls the Target Device RESET pin. It will driven HIGH/LOW according to the device type and settings in the <Pre-program State Machine> tab in the Eqtools project. Warning! During 'High Voltage Serial Programming' of the Atmel ATtiny11/12/15 microcontrollers, a +12V Vpp voltage is generated by the programmer on this pin.

O - Output from programmer to Target Device
I - Input to programmer from Target Device
P - Passive e.g. GROUND and power rails
N/C - Not connected

3.6 Equinox 10-way Header (ATtiny11/12/15 HV Interface)

This connection method is suitable for interfacing the programmer to a Target System which features the following:

- Equinox 10-way IDC ISP Header
- An Atmel ATtiny microcontroller e.g. ATtiny11/12/15
- Suitable connections to implement 'High Voltage Serial Programming Mode'.

The connector supports programming of the Atmel ATtiny11/12/15 microcontrollers in 'High Voltage Serial Programming Mode'. This mode requires that a +12.0V Vpp voltage is applied to the RESET pin of the target device in order to enter programming mode.

To implement this connection, simply plug the 10-way ISP cable into the 10-way header marked 'Equinox' and plug the other end of the cable into the matching header on the Target System. Please ensure that you have made the correct connections from the ISP Header to your Target Device.

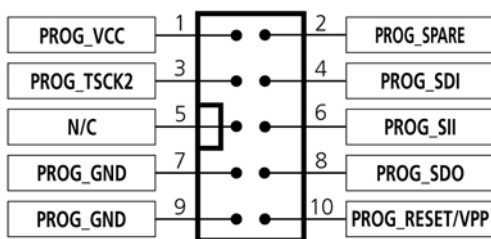

Figure 4.6.1 – Equinox 10-way IDC Header (J8) viewed from above

Warning!

1. It is possible for +12V to be output on pin 10 of this connector when programming ATtiny11/12/15 devices.
2. Connecting to the wrong ISP Header may cause catastrophic damage to the Programmer & Target System

Pin No	Programmer Pin name	Programmer Input / Output	Connect to pin on Target Device	Description
1	PROG_VCC	P	TARGET_VCC	Target VCC This pin should be connected to the Target System Vcc. This voltage could be used to power the programmer depending on the settings of the power switch/jumper on the programmer.
2	PROG_SPARE	-	No connect	Spare Programmer I/O pin This pin is currently a spare I/O pin which is not used during SPI programming. In order to use this pin, the pin state must be set up in the EQTools <Pre-programming State Machine> tab.
3	PROG_TSCK2	O	XTAL1	SCK2 Clock Output This output pin is used to supply an external clock signal (SCK2) to the target microcontroller.

4	PROG_SDI	O	SDI	<p>Serial Data Input This is the serial data output pin from the programmer. This pin should be connected to the Serial Data Input (SDI) pin on the Target Microcontroller.</p>
5	N/C	O	N/C	Not connected
6	PROG_SII	O	SII	<p>SII (Serial Instruction Input) This is the serial data input pin to the programmer from the Target Device. This pin should be connected to the SII pin on the Target Microcontroller.</p>
7	PROG_GND	P	GROUND	<p>Ground Connection Common ground connection between PROGRAMMER and Target System.</p>
8	PROG_SDO	I	SDO	<p>SDO (Serial Data Output) This is the serial data output signal from the Target Device to the programmer. It is an INPUT pin to the programmer.</p>
9	PROG_GND	P	GROUND	<p>Ground Connection Common ground connection between PROGRAMMER and Target System.</p>
10	PROG_RESET/VPP	O	RESET	<p>Target RESET control pin This pin controls the Target Device RESET pin. A +12.0V Vpp voltage will be applied to this pin during programming.</p> <p>Warning! During 'High Voltage Serial Programming' of the Atmel ATtiny11/12/15 microcontrollers, a +12V Vpp voltage is generated by the programmer on this pin.</p>

Key

O - Output from programmer to Target Device

I - Input to programmer from Target Device

P - Passive eg. GROUND and power rails

N/C - Not connected

3.7 Equinox 10-way Header (UART Boot Loader)

This connection method is suitable for interfacing the programmer to a Target System which features the following:

- Equinox 10-way IDC ISP Header
- An Atmel Wireless T89C51Rx2 / CC01 microcontroller
- A Philips P89C51Rx2 or P89C66x microcontroller
- The relevant connections for in-system programming via the Boot Loader.

To implement this connection, simply plug the 10-way ISP cable into the ISP header marked 'Equinox' and plug the other end of the cable into the matching header on the Target System.

Please note:

The programmer interfaces to the Target System at TTL voltage levels. If the serial port to your Target System is RS-232, you will need to convert the TTL levels from the programmer to RS-232 using an external converter.

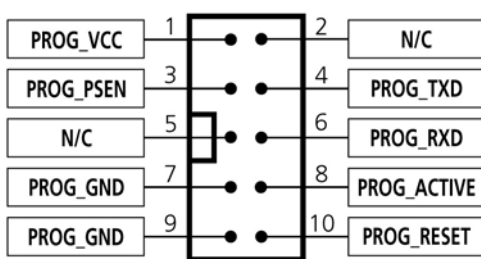

Figure 4.7.1 – Equinox 10-way IDC Header (J8) viewed from above

Warning!

1. It is possible for +12V to be output on pin 10 of this connector when programming ATtiny11/12/15 devices.
2. Connecting to the wrong ISP Header may cause catastrophic damage to the Programmer & Target System

Pin No	Programmer Pin name	Programmer Input / Output	Connect to pin on Target Device	Description
1	PROG_VCC	P	TARGET_VCC	Target Vcc This pin should be connected to the Target System Vcc. This voltage could be used to power the programmer depending on the settings of the power switch/jumper on the programmer.
2	N/C	-	N/C	Not connected
3	PROG_PSEN	O	PSEN	PSEN pin This pin is driven LOW by the programmer to enter 'Boot Loader' programming mode.
4	PROG_TXD	O	RXD	Programmer RXD (Transmit) pin The programmer transmits serial data on this pin to the Target Device RXD (Receive) pin.

5	N/C	-	N/C	Not Connected
6	PROG_RXD	I	TXD	Programmer RXD (Transmit) pin The programmer receives serial data on this pin from the Target Device TXD (Transmit) pin.
7	PROG_GND	P	Ground Connection	Target / Programmer GROUND connection Common ground connection between PROGRAMMER and Target System.
8	PROG_ACTIVE	O	LED or Interrupt pin	Programmer ACTIVE LED This pin can be driven LOW when a programming action is taking place. The signal can be used to illuminate an LED or trigger an interrupt on the Target Microcontroller.
9	PROG_GND	P	Ground Connection	Target / Programmer GROUND connection Common ground connection between PROGRAMMER and Target System.
10	PROG_RESET	O	RESET	Target RESET control pin This pin controls the Target Device RESET pin. It will driven HIGH/LOW according to the device type and settings in the 'Pre-program State Machine' tab in the Eqtools project. Warning! During 'High Voltage Serial Programming' of the Atmel ATtiny11/12/15 microcontrollers, a +12V Vpp voltage is generated by the programmer on this pin.

Key

O - Output from programmer to Target Device
 I - Input to programmer from Target Device
 P - Passive eg. GROUND and power rails
 N/C - Not connected

3.8 Atmel 10-way Header (SPI Interface)

This connection method is suitable for interfacing the programmer to a Target System which features the following:

- Atmel 10-way IDC ISP Header
- An Atmel device which features the 3-wire SPI + RESET Programming Interface

This connector is compatible with the Atmel STK200, STK300 and STK500 Starter Kits. Equinox would recommend not using this connector on new designs, but instead using the 'Equinox 10-way Header' as the Equinox header caters for an External Oscillator, Vpp switching and also features a spare I/O pin for future expandability.

To implement this connection, simply plug the 10-way ISP cable into the 6-way header marked 'Atmel' and plug the other end of the cable into the matching header on the Target System.

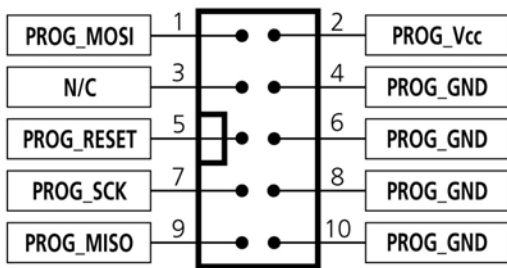

Figure 4.8.1 - Atmel 10-way IDC Header (J7) viewed from above

Warning!

Connecting to the wrong ISP Header may cause catastrophic damage to the Programmer & Target System

Pin No	Pin name	Programmer Input / Output	Connect to pin on Target Device	Description
1	PROG_MOSI-1	O	MOSI (except for ATmega103/128/64 – connect to RXD pin instead)	Master Out Slave In This is the SPI data output pin from the programmer. This pin should be connected to the MOSI pin on the Target Microcontroller.
2	PROG_VCC	P	TARGET_VCC	Target Vcc This pin should be connected to the Target System Vcc. This voltage could be used to power the programmer depending on the settings of the power switch/jumper on the programmer.
3	N/C	-	N/C	Not connected
4	PROG_GND	P	GROUND	Ground Connection Common ground connection between the programmer and Target System.

5	PROG_RESET	O	RESET	Target RESET control pin This pin controls the Target Device RESET pin. It will driven HIGH/LOW according to the device type and settings in the 'Pre-program State Machine' tab in the Eqtools project.
6	PROG_GND	P	GROUND	Ground Connection Common ground connection between the programmer and Target System.
7	PROG_SCK1	O	SCK	SPI Serial Clock Output This is the SPI clock output signal.
8	PROG_GND	P	GROUND	Ground Connection Common ground connection between the programmer and Target System.
9	PROG_MISO	I	MISO (except for ATmega103/128/64 – connect to TXD pin instead)	Master In Slave Out This is the SPI data input pin to the programmer. This pin should be connected to the MISO pin on the Target Microcontroller.
10	PROG_GND	P	GROUND	Ground Connection Common ground connection between PROGRAMMER and Target System.

Key

O - Output from programmer to Target Device

I - Input to programmer from Target Device

P - Passive eg. GROUND and power rails

N/C - Not connected

3.9 Atmel 10-way JTAG Header (JTAG Interface)

This connection method is suitable for interfacing the programmer to a Target System which features the following:

- An Atmel device which features a JTAG ISP port e.g. ATmega16 / 32 / 64 / 128 / 169 / 323.
- Atmel 10-way IDC JTAG Header
- This is the same header as used on the Atmel JTAG-ICE emulator.

To implement this connection, simply plug the 10-way ISP cable into the 10-way ISP Header marked 'JTAG' and plug the other end of the cable into the matching header on the Target System.

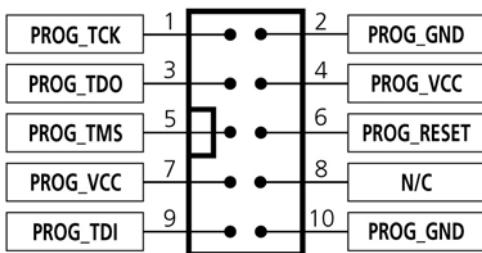

Figure 4.9.1 - Atmel 10-way IDC Header (J8) viewed from above

Warning!

Connecting to the wrong ISP Header may cause catastrophic damage to the Programmer & Target System

Pin No	Programmer Pin name	Programmer Input / Output	Connect to pin on Target Device	Description
1	PROG_TCK	O	TCK	JTAG TCK – Test Clock Signal pin Clock signal from programmer to Target Device JTAG port.
2	PROG_GND	P	GROUND	Ground Connection Common ground connection between Programmer and Target System.
3	PROG_TDO	I	TDO	JTAG TDO – Test Data Output pin Data signal from Target device JTAG port to programmer.
4	PROG_VCC	P	TARGET_VCC	Target Vcc Connection - Pins 4 + 7 are physically connected inside the programmer. - Connects to Vcc rail of Target System. - Pin referred to as VTref on Atmel JTAG-ICE.
5	PROG_TMS	O	TMS	JTAG TMS – Test Mode Select pin Mode Select Signal from programmer to Target Device JTAG port.
6	PROG_RESET	O	RESET	Microcontroller RESET control signal This pin connects to the main RESET pin of the Target Microcontroller. This pin is not strictly needed for JTAG programming, but it can be used to RESET the Target Device before and after programming.

7	PROG_VCC	P	TARGET_VCC	Target Vcc Connection - See pin 4 - Pins 4 + 7 are physically connected inside the programmer.
8	N/C	O	N/C	Not Connected
9	PROG_TDI	O	TDI	JTAG TDI – Test Data Input pin Data signal from programmer to Target Device JTAG port.
10	PROG_GND	P	GROUND	Ground Connection Common ground connection between PROGRAMMER and Target System.

Key

O - Output from programmer to Target Device

I - Input to programmer from Target Device

P - Passive eg. GROUND and power rails

N/C - Not connected

4.0 I2C Programming Connections

4.1 Overview

The programmer supports programming of I2C devices using the I2C pins SDA and SCL.

4.2 Atmel 6-way ISP Header (I2C – 2-wire Interface)

This connection method

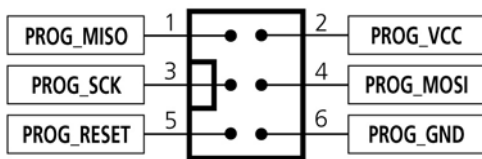

Figure 4.4.1 - Atmel 6-way IDC Header (J3) viewed from above

Warning!

Connecting to the wrong ISP Header may cause catastrophic damage to the Programmer & Target System

4.3 Equinox 10-way ISP Header (I2C – 2-wire Interface)

This connection method

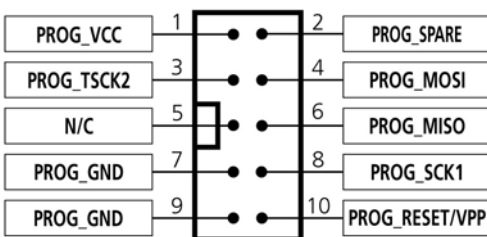

Figure 4.5.1 – Equinox 10-way IDC Header (J8) viewed from above

Warning!

3. It is possible for +12V to be output on pin 10 of this connector when programming ATtiny11/12/15 devices.
4. Connecting to the wrong ISP Header may cause catastrophic damage to the Programmer & Target System



PPM3 I/O Connector Modules

4.0 ISP Cable considerations

The programmer is supplied with a single 10-way ISP Cable as standard. This cable is terminated with a 10-way IDC 0.1" female polarised plug at each end. The cable is wired as a so-called 'straight-through' cable with pin 1-1, 2-2 etc. The polarised ISP Header ensures that the ISP Cable cannot be plugged in the wrong way around by mistake. If you are planning to design such a header onto your Target System, it is strongly recommended that a similar polarised header is used. This will help to prevent accidental damage to both the programmer and the Target System.

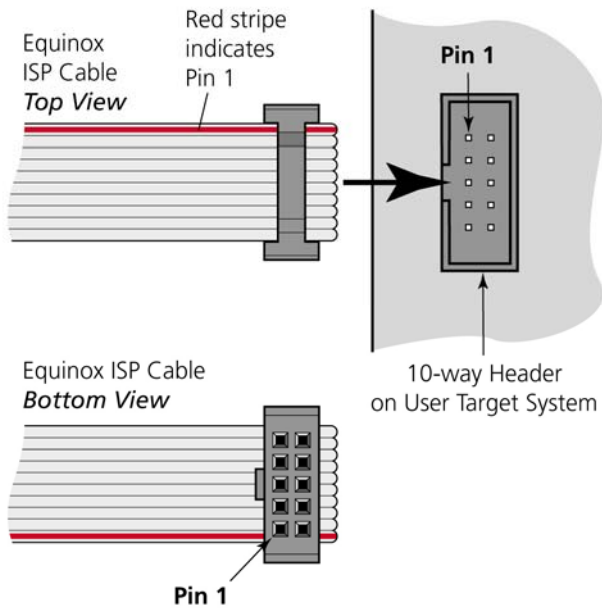

Pin 1 of the ISP cable can be determined by looking for a small arrow on the plastic part of the ISP female plug. If the cable has a RED stripe on one cable, this usually also indicates pin 1.

If you are using the programmer in a production environment and constantly plugging / unplugging the ISP cable into/from the Target System, you may find that the cable eventually fails. Spare ISP cables can be ordered from Equinox in this eventuality.

5.0 Power Connections + Vcc Sense

5.1 Overview

The PPM3 programmer supports the following power supply options:

#	Description
1	Programmer provides controlled power (3.0 – 5.0V) to the Target System
2	Programmer provides static +5V DC to the Target System
3	Programmer and Target System are independently powered
4	Target System powers the Programmer (+5V DC only)

The setup for the above Power Supply Options is beyond the scope of this manual. Please refer to the 'PPM3 – User Manual – Power Supply' section for further information.

5.2 Vcc Option Link

This link is used to connect the programmer internal +5V supply to the 'I/O Level Converters' and also to the 'Target Vcc'. This link should NOT be fitted unless the programmer is to provide a static +5V DC to the Target System. . Please refer to the 'PPM3 – User Manual – Power Supply' section for further information.

5.3 Target Vcc Sense LED

This LED will illuminate when the Target Vcc reaches a threshold value. The sense circuit is powered from the Programmer Vcc so as not to load the Target Vcc.

6.0 IO-CON-1 Module

6.1 Overview

This IO-CON module is designed for use with any Atmel microcontroller which can be programmed via the 3-wire SPI port + RESET. Supported devices include the Atmel 89S, AT90S, ATmega and ATtiny devices families. The module features the Equinox and Atmel 10-way ISP headers plus two 'Fast connect connectors' which allow wires to be manually clipped in. Please refer to Section 3 for a detailed description and pin-out of the 6-way and 10-way ISP headers.

6.2 Features

- Plugs into suitable Equinox programmer eg. PPM3 Module
- Atmel 10-way IDC ISP Header
- Atmel 6-way IDC ISP Header
- Equinox 10-way IDC ISP header
- 'Fast Connect' clip-in connectors for direct wiring to Test Fixture i.e wires from bed-of-nails probe wires
- Screw terminals for power connections
- Target Vcc Status LED
- Link to connect / isolate the programmer Vcc from the Target Vcc

6.3 Support Device Families

This I/O Connection Module supports ISP programming of the following device families:

Low / High Voltage SPI programming algorithm:

- Atmel AT89S (LV SPI)
- Atmel AT90S (LV SPI)
- Atmel ATtiny (LV SPI)
- Atmel ATtiny (High Voltage)
- Atmel ATmega (LV SPI)
- Atmel 90CAN (LV SPI)
- Atmel 90USB (LV SPI)
- Atmel 90PWM (LV SPI)
- Atmel ATmega PICO (LV SPI)
- Zensys ZW (LV SPI)

I2C Serial EEPROM programming algorithm:

- Atmel AT24C
- Atmel AT24HC
- Atmel AT34C

UART – Boot Loader' algorithm:

- Atmel T89C51Rx2 (UART – Boot Loader)
- Philips P89C51Rx2 (UART – Boot Loader)
- Philips P89C66x (UART – Boot Loader)

6.4 Connector Layout Schematic

The relative positions and orientation of the various connectors on this module are shown in fig. 6.4.1. below. Please refer to fig. 6.4.2 for an explanation of each item.

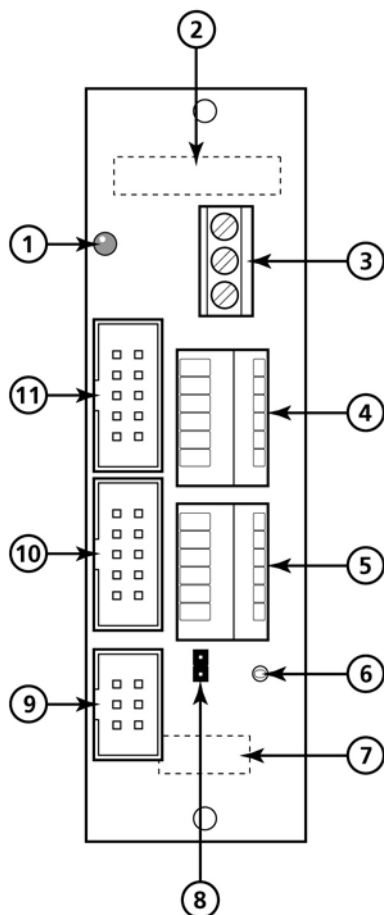

Figure 6.4.1

Item ref	Part no	Part Description	Functional Description
1	LED1	RED LED	Power is applied to PPM3
2	J5	PCB interconnect	PCB inter-connectors (on underside of board)
3	J29	Power supply input	DC Power input connector – screw terminal
4	J21	Target Fast connector 1	Clip in Fast-connect connector (6-way)
5	J22	Target Fast connector 2	Clip in Fast-connect connector (6-way)
6	TP2	Scope Test Point	Scope ground test point
7	J12	PCB interconnect	PCB inter-connectors (on underside of board)
8	J28	Vcc Select	Jumper to allow connection of PPM3 Vcc to target Vcc
9	J30	6-way Header	Atmel 6-way IDC 0.1" ISP Header
10	J20	10-way Header	Atmel 10-way IDC 0.1" ISP Header
11	J19	10-way Header	Equinox 10-way IDC 0.1" ISP Header

Figure 6.4-2

6.5 ISP Header Connectors

This module features the following ISP IDC Headers:

- Equinox 10-way IDC ISP Header
- Atmel 6-way IDC ISP Header
- Atmel 10-way IDC ISP Header

Please refer to section 3 for details of the pin-outs of each of the above connectors.

6.6 Clip-In Fast-Connectors

The 'Fast-Connect' connectors J21 and J22 allow direct wiring of a Test Fixture to the programmer by simply clipping the bare end of the each Test Lead into the relevant pin of the connector. This method of connection is for connecting to a Test Fixture as wires can easily be interchanged without having to de-solder connections or make new cables.

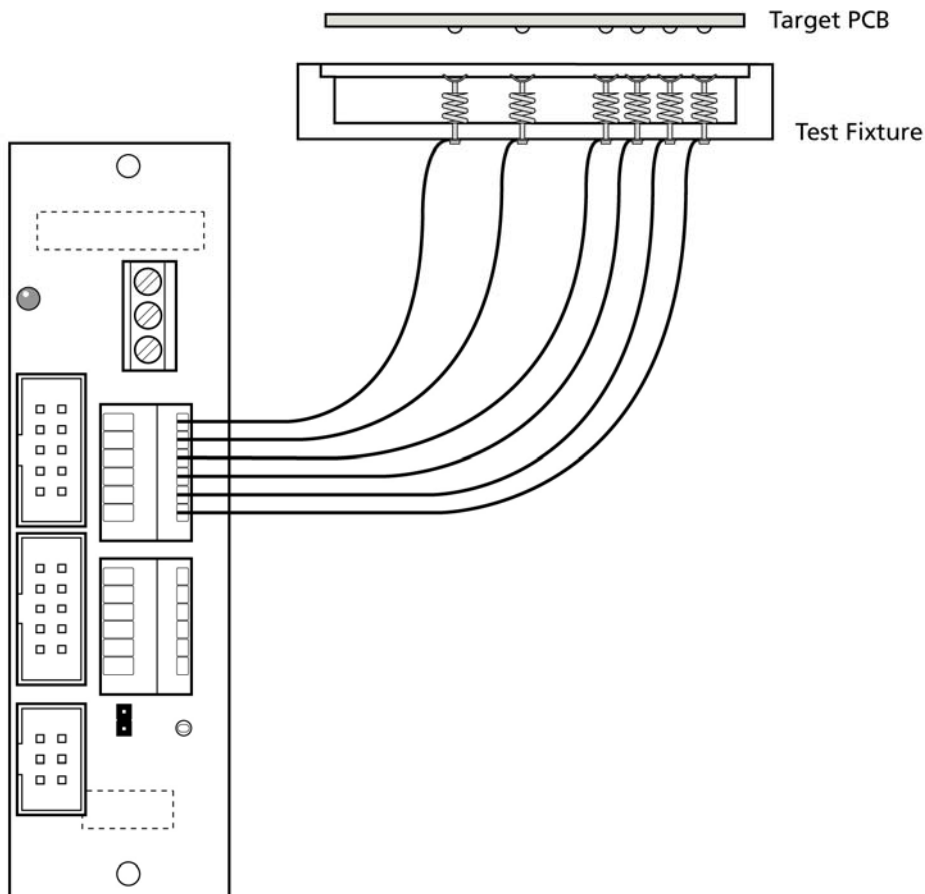

Figure 6.6.1 – Use of Fast-Connector to connect to a Test Fixture

The pin-out of the two 'Fast –Connectors' are shown in fig 6.5.2 and 6.5.3.

- J21 features the actual signals used to program the Target Device.
- J22 features the 'Remote Control' signals for the programmer.

Pin No.	Title	I/O	Description
1	SCK1	O	SPI Serial Clock Signal
2	SCK2	O	External clock drive
3	MOSI	O	Master Out Slave In 1 (standard 3-wire SPI)
4	MISO	I	Master In Slave Out
5	MOSI-2	O	Master Out Slave In 2 (ATtiny High Voltage 4-wire SPI)
6	RESET	O	Target RESET Control Signal

Figure 6.6.2 – Clip-in Fast-Connector (J21)

Pin No.	Title	I/O	Description
1	REMOTE_START	I	Remote <Start> Input Signal (3V –12 V DC)
2	ANA1	I	Spare Input Line (referenced to Target Vcc)
3	FAIL	O	FAIL (output)
4	OK	O	PASS (output)
5	TARGET_VCC	P	Target Vcc Voltage
6	TARGET_GND	P	Target GROUND

Figure 6.6.3 – Clip-in Fast-Connector (J22)

6.7 Power Connector – Screw terminals (J29)

The power supply connections for GROUND, PROGRAMMER_VCC and a +9.0V DC output are available on screw terminals if required.

Pin No.	Title	I/O	Description
1	GND	P	Common Ground Connection
2	PROGRAMMER_VCC	P	Programmer Vcc Voltage (+5.0V regulated)
3	+9V	P	Unregulated input supply to PPM3 from external power supply. This is the voltage applied from an external power supply to PPM3 Power Connectors J6 or J15.

Figure 6.7.1 – Power Connector – Screw Terminals (J29)

7.0 IO-CON-2 Module

7.1 Overview

This IO-CON module is designed for use with any Atmel microcontroller which can be programmed via the 3-wire SPI port + RESET. Supported devices include the Atmel 89S, AT90S, ATmega and ATtiny devices families. The module features the Equinox and Atmel 10-way ISP headers plus a 'Wire-wrap' connector suitable for wire-wrapping connections from a Test Fixture. Please refer to Section 3 for a detailed description and pin-out of the 6-way and 10-way ISP headers.

7.2 Features

- Plugs into suitable Equinox programmer eg. PPM3 Module
- Atmel 10-way IDC ISP Header
- Atmel 6-way IDC ISP Header
- Equinox 10-way IDC ISP header
- Single-in-line header with all programmer I/O brought out for wire-wrapping to bed-of-nails probe wires
- Screw terminals for power connections
- Target Vcc Status LED
- Link to connect / isolate the programmer Vcc from the Target Vcc

7.3 Device Family Support

This I/O Connection Module supports ISP programming of the following device families:

Low / High Voltage SPI programming algorithm:

- Atmel AT89S (LV SPI)
- Atmel AT90S (LV SPI)
- Atmel ATtiny (LV SPI)
- Atmel ATtiny (High Voltage)
- Atmel ATmega (LV SPI)
- Atmel 90CAN (LV SPI)
- Atmel 90USB (LV SPI)
- Atmel 90PWM (LV SPI)
- Atmel ATmega PICO (LV SPI)
- Zensys ZW (LV SPI)

I2C Serial EEPROM programming algorithm:

- Atmel AT24C
- Atmel AT24HC
- Atmel AT34C

UART – Boot Loader' algorithm:

- Atmel T89C51Rx2 (UART – Boot Loader)
- Philips P89C51Rx2 (UART – Boot Loader)
- Philips P89C66x (UART – Boot Loader)

7.4 Connector Layout schematic

The relative positions and orientation of the various connectors on this module are shown in fig. 7.4.1 below. Please refer to figure 7.4.2 for an explanation of each item.

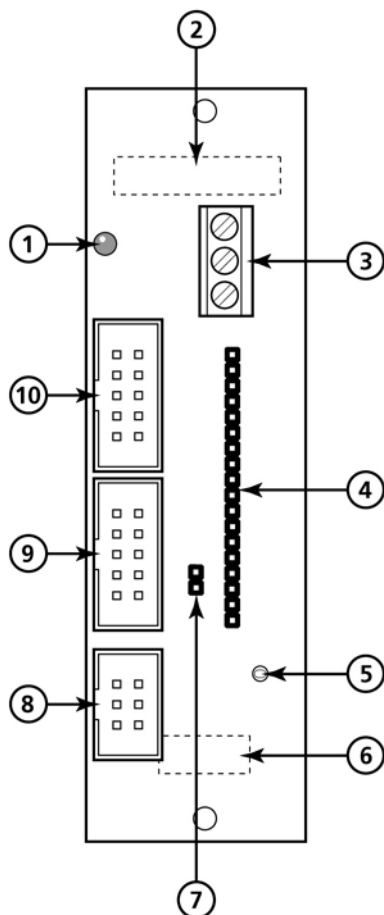
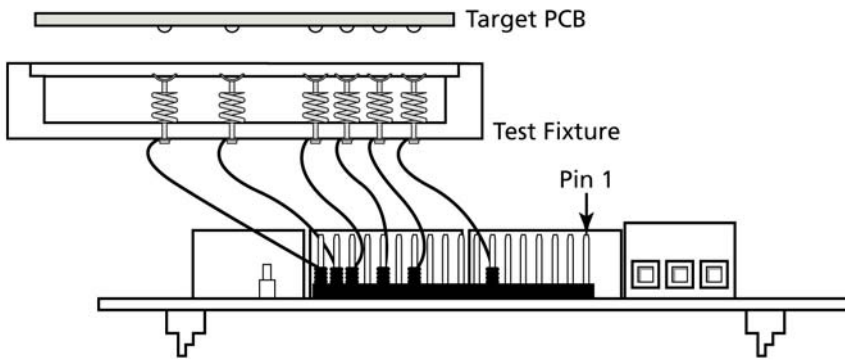

Figure 7.4.1

Item ref	Part no	Part Description	Functional Description
1	LED1	RED LED	Indicates that Target Vcc is present
2	J5	PCB interconnect	PCB inter-connectors (on underside of board)
3	J27	Power supply input	DC Power input connector – screw terminal
4	J25	Wire wrap pins	Wire wrap pins to target (see PCB for pin descriptions)
5	TP1	Scope test point	Scope ground test point
6	J12	PCB interconnect	PCB inter-connectors (on underside of board)
7	J26	Vcc Select	Jumper to allow connection of PPM3 Vcc to target Vcc
8	J31	6-way Header	Atmel 6-way IDC 0.1" SPI Header
9	J24	10-way Header	Atmel 10-way IDC 0.1" SPI Header
10	J23	10-way Header	Equinox 10-way IDC 0.1" ISP Header

Figure 7.4.2

PPM3 I/O Connector Modules



8.0 IO-CON-3 Module (JTAG)

8.1 Overview

This IO-CON module is primarily designed for JTAG ISP of the Atmel ATmega microcontroller family. It also supports ISP programming via SPI using the 3-wire SPI port + RESET. Supported devices include the Atmel 89S, AT90S, ATmega and ATtiny devices families. The module features the Equinox and Atmel 10-way ISP headers plus two 'Fast connect connectors' which allow wires to be manually clipped in. Please refer to Section 3 for a detailed description and pin-out of the 6-way and 10-way ISP headers.

8.2 Features

- Plugs into suitable Equinox programmer eg. PPM3 Module
- Atmel 10-way JTAG IDC ISP connector (same as JTAG-ICE)
- Atmel 6-way IDC ISP Header
- Equinox 10-way IDC ISP header
- 'Fast Connect' clip-in connectors for direct wiring to Test Fixture i.e wires from bed-of-nails probe wires
- Screw terminals for power connections
- Target Vcc Status LED
- Link to connect / isolate the programmer Vcc from the Target Vcc

Please note:

The 'Atmel AVR JTAG License' (Order code: PPM3A1-UPG7) is also required to enable the PPM3 to program Atmel AVR devices via JTAG.

8.3 Support Device Families

This I/O Connection Module supports ISP programming of the following device families using the low / high voltage SPI programming algorithm:

- Atmel AT89S (LV SPI)
- Atmel AT90S (LV SPI)
- Atmel ATtiny (LV SPI)
- Atmel ATtiny (High Voltage)
- Atmel ATmega (LV SPI)
- Atmel 90CAN (LV SPI)
- Atmel 90CAN (JTAG)
- Atmel 90USB (LV SPI)
- Atmel 90USB (JTAG)
- Atmel 90PWM (LV SPI)
- Atmel ATmega PICO (LV SPI)
- Atmel ATmega PICO (JTAG)
- Zensys ZW (LV SPI)

This I/O Connection Module supports ISP programming of the following device families using the I2C Serial EEPROM programming algorithm:

- Atmel AT24C
- Atmel AT24HC
- Atmel AT34C

This I/O Connection Module supports ISP programming of the following device families using the UART – Boot Loader’ algorithm:

- Atmel T89C51Rx2 (UART – Boot Loader)
- Philips P89C51Rx2 (UART – Boot Loader)
- Philips P89C66x (UART – Boot Loader)

8.4 Connector Layout schematic

The relative positions and orientation of the various connectors on this module are shown in fig. 6.4.1 below. Please refer to figure 6.4.2 for an explanation of each item.

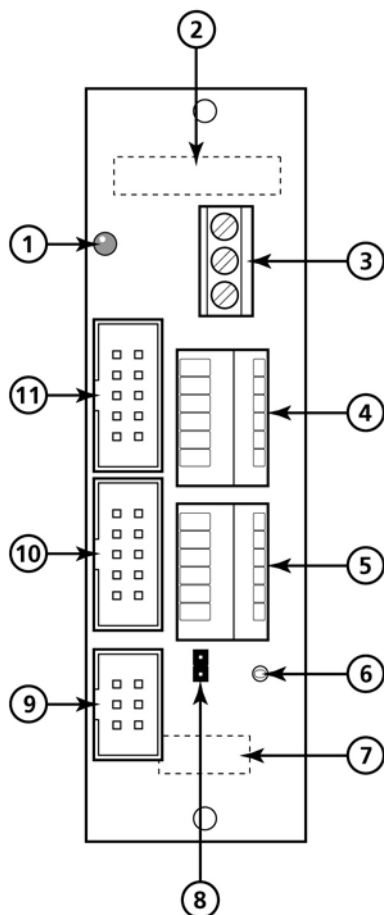

Figure 8.4.1

Item ref	Part no	Part Description	Functional Description
1	LED1	RED LED	Power is applied to PPM3
2	J5	PCB interconnect	PCB inter-connectors (on underside of board)
3	J29	Power supply input	DC Power input connector – screw terminal
4	J21	Target Fast connector 1	Clip in Fast-connect connector (6-way)
5	J22	Target Fast connector 2	Clip in Fast-connect connector (6-way)
6	TP2	Scope Test Point	Scope ground test point
7	J12	PCB interconnect	PCB inter-connectors (on underside of board)
8	J28	Vcc Select	Jumper to allow connection of PPM3 Vcc to target Vcc
9	J30	6-way Header	Atmel 6-way IDC 0.1" ISP Header
10	J20	10-way Header	JTAG 10-way IDC 0.1" ISP Header
11	J19	10-way Header	Equinox 10-way IDC 0.1" ISP Header

Figure 8.4-2

8.5 Clip-In fast Connector (J3 & J4)

The 'Fast-Connect' connectors J3 and J4 allow direct wiring of a Test Fixture to the programmer by simply clipping the bare end of the each Test Lead into the relevant pin of the connector. This method of connection is for connecting to a Test Fixture as wires can easily be interchanged without having to desolder connections or make new cables.

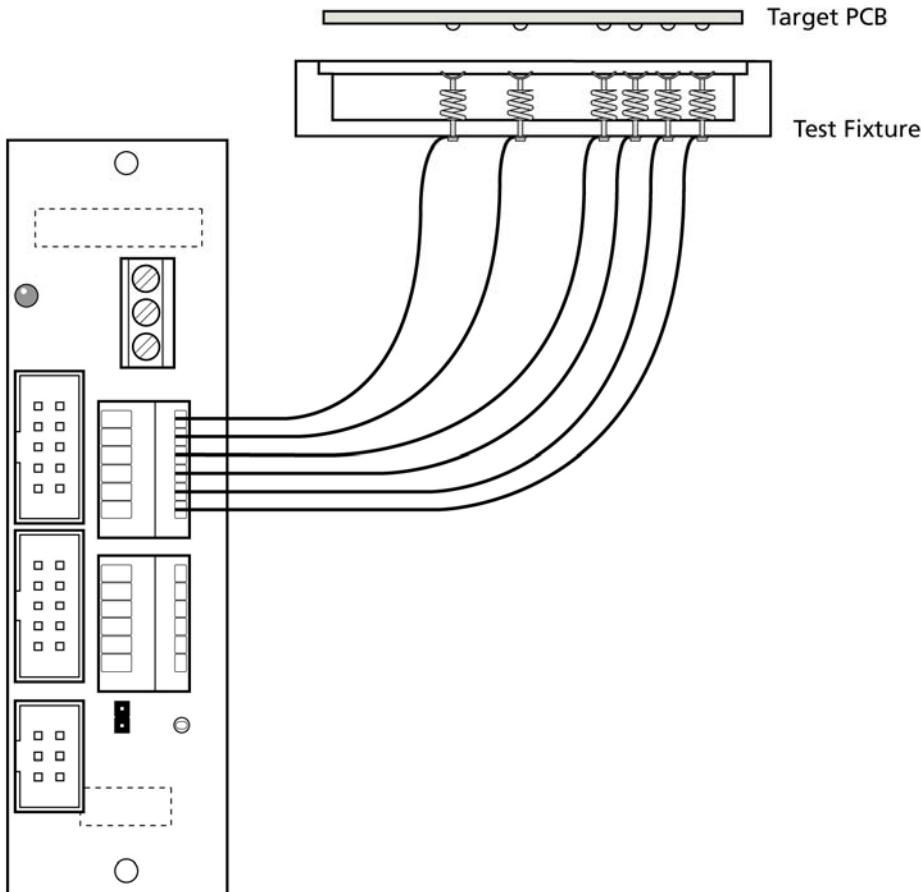

Figure 8.5.1 – Use of Fast-Connector to connect to a Test Fixture

The pin-out of the two 'Fast –Connectors' are shown in fig 6.5.2 and 6.5.3.

- J3 features the actual signals used to program the Target Device.
- J4 features the 'Remote Control' signals for the programmer

Pin No.	Title	I/O	Description
1	PROG_TCK	O	JTAG TCK – Test Clock Signal pin Clock signal from programmer to Target Device JTAG port.
2	PROG_TDO	O	JTAG TDO – Test Data Output pin Data signal from Target device JTAG port to programmer.
3	PROG_TMS	O	JTAG TMS – Test Mode Select pin Mode Select Signal from programmer to Target Device JTAG port.
4	PROG_TDI	I	JTAG TDI – Test Data Input pin Data signal from programmer to Target Device JTAG port.
5	RESET	O	Microcontroller RESET control signal This pin connects to the main RESET pin of the Target Microcontroller. This pin is not strictly needed for JTAG programming, but it can be used to RESET the Target Device before and after programming.
6	SPARE1	O	Spare I/O pin 1 Available for user-defined purpose.

Figure 8.5.2 – Clip-in Fast-Connector (J3)

Pin No.	Title	I/O	Description
1	REMOTE_START	I	Remote <Start> Input Signal (3V –12 V DC)
2	ANA1	I	Spare Input Line (referenced to Target Vcc)
3	FAIL	O	FAIL (output)
4	OK	O	PASS (output)
5	TARGET_VCC	P	Target Vcc Voltage (generated by external PSU)
6	TARGET_GND	P	Target GROUND

Figure 8.5.3 – Clip-in Fast-Connector (J4)

9.0 EQ-CALCON Module

9.1 Overview

The EQ-CALCON Module is a special plug-in I/O Connector Module for the PPM3-MK2 programmer which is used to facilitate very accurate calibration of the Internal Oscillator of an Atmel ATmega or ATtiny AVR microcontroller. The module features an on-board high accuracy 32kHz Oscillator Module which can be connected to the target AVR microcontroller MOSI pin during the Oscillator Calibration Procedure as described in the Atmel Application Note 'AVR053: Calibration of the Internal Oscillator'.

The EQ-CALCON Module is simply an I/O Connection Module with an on-board 32kHz oscillator. The target microcontroller SPI or JTAG signal lines connect to the module headers or clip-in connectors. The 32kHz oscillator is then switched onto the target device MOSI pin under control of the Programming Project running in the programmer. The EQ-CALCON Module must be used in conjunction with a PPM3-MK2 programmer in order to operate.

9.2 Features

- Plugs into I/O Con connector socket on PPM3-MK2 programmer
- Generates an accurate 32kHz square wave signal under control of the programmer
- Support calibration of the on-chip oscillator of Atmel AVR microcontrollers
- Features Atmel 6-way SPI, Atmel JTAG 10-way and Equinox 10-way SPI ISP headers
- Features clip-in 'Fast Connect' connectors for east connection to wires from Test Probes in a Test Fixture environment

9.3 Supported Device Families

This CALCON supports ISP programming of the following device families:

Low / High Voltage SPI programming algorithm:

- Atmel AT89S (LV SPI)
- Atmel AT90S (LV SPI)
- Atmel ATtiny (LV SPI)
- Atmel ATtiny (High Voltage)
- Atmel ATmega (LV SPI)
- Atmel 90CAN (LV SPI)
- Atmel 90USB (LV SPI)
- Atmel 90PWM (LV SPI)
- Atmel ATmega PICO (LV SPI)
- Zensys ZW (LV SPI)

9.4 Connector Layout Schematic

The relative positions and orientation of the various connectors on this module are shown in fig. 9.4.1. below. Please refer to fig. 9.4.2 for an explanation of each item.

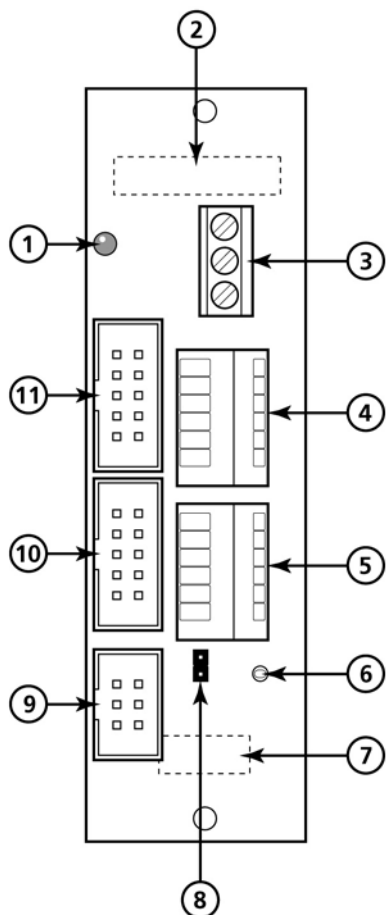

Figure 9.4.1

Item ref	Part no	Part Description	Functional Description
1	LED1	RED LED	Power is applied to PPM3
2	J5	PCB interconnect	PCB inter-connectors (on underside of board)
3	J29	Power supply input	DC Power input connector – screw terminal
4	J21	Target Fast connector 1	Clip in Fast-connect connector (6-way)
5	J22	Target Fast connector 2	Clip in Fast-connect connector (6-way)
6	TP2	Scope Test Point	Scope ground test point
7	J12	PCB interconnect	PCB inter-connectors (on underside of board)
8	J28	Vcc Select	Jumper to allow connection of PPM3 Vcc to target Vcc
9	J30	6-way Header	Atmel 6-way IDC 0.1" ISP Header
10	J20	10-way Header	Atmel 10-way IDC 0.1" JTAG Header
11	J19	10-way Header	Equinox 10-way IDC 0.1" ISP Header

Figure 9.4-2

9.5 ISP Header Connectors

This module features the following ISP IDC Headers:

- Equinox 10-way IDC ISP Header
- Atmel 6-way IDC ISP Header
- Atmel 10-way JTAG IDC Header

Please refer to section 3 for details of the pin-outs of each of the above connectors.

9.6 Clip-In Fast-Connectors

The 'Fast-Connect' connectors J21 and J22 allow direct wiring of a Test Fixture to the programmer by simply clipping the bare end of the each Test Lead into the relevant pin of the connector. This method of connection is for connecting to a Test Fixture as wires can easily be interchanged without having to de-solder connections or make new cables.

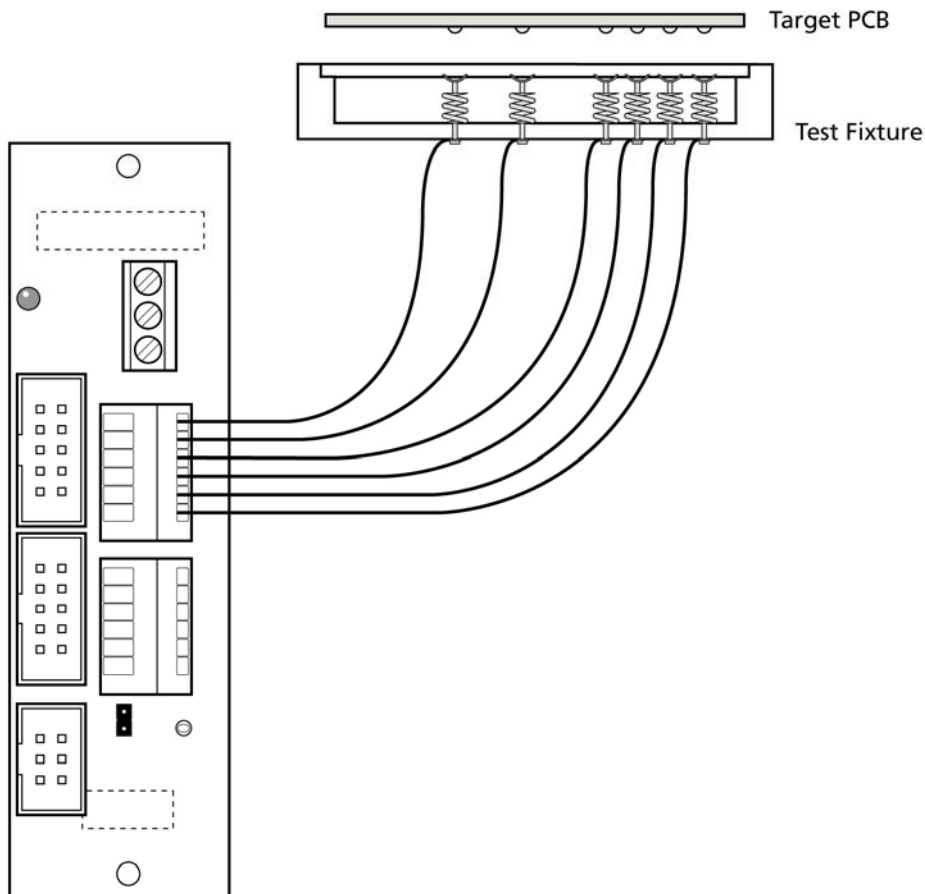

Figure 9.6.1 – Use of Fast-Connector to connect to a Test Fixture

The pin-out of the two 'Fast –Connectors' are shown in fig 9.6.2 and 9.5.3.

- J21 features the actual signals used to program the Target Device.
- J22 features the 'Remote Control' signals for the programmer.

Pin No.	Title	I/O	Description
1	SCK1	O	SPI Serial Clock Signal
2	SCK2	O	External clock drive
3	MOSI	O	Master Out Slave In 1 (standard 3-wire SPI)
4	MISO	I	Master In Slave Out
5	MOSI-2	O	Master Out Slave In 2 (ATtiny High Voltage 4-wire SPI)
6	RESET	O	Target RESET Control Signal

Figure 9.6.2 – Clip-in Fast-Connector (J21)

Pin No.	Title	I/O	Description
1	REMOTE_START	I	Remote <Start> Input Signal (3V –12 V DC)
2	ANA1	I	Spare Input Line (referenced to Target Vcc)
3	FAIL	O	FAIL (output)
4	OK	O	PASS (output)
5	TARGET_VCC	P	Target Vcc Voltage
6	TARGET_GND	P	Target GROUND

Figure 9.6.3 – Clip-in Fast-Connector (J22)

9.7 Power Connector – Screw terminals (J29)

The power supply connections for GROUND, PROGRAMMER_VCC and a +9.0V DC output are available on screw terminals if required.

Pin No.	Title	I/O	Description
1	GND	P	Common Ground Connection
2	PROGRAMMER_VCC	P	Programmer Vcc Voltage (+5.0V regulated)
3	+9V	P	Unregulated input supply to PPM3 from external power supply. This is the voltage applied from an external power supply to PPM3 Power Connectors J6 or J15.

Figure 9.7.1 – Power Connector – Screw Terminals (J29)