

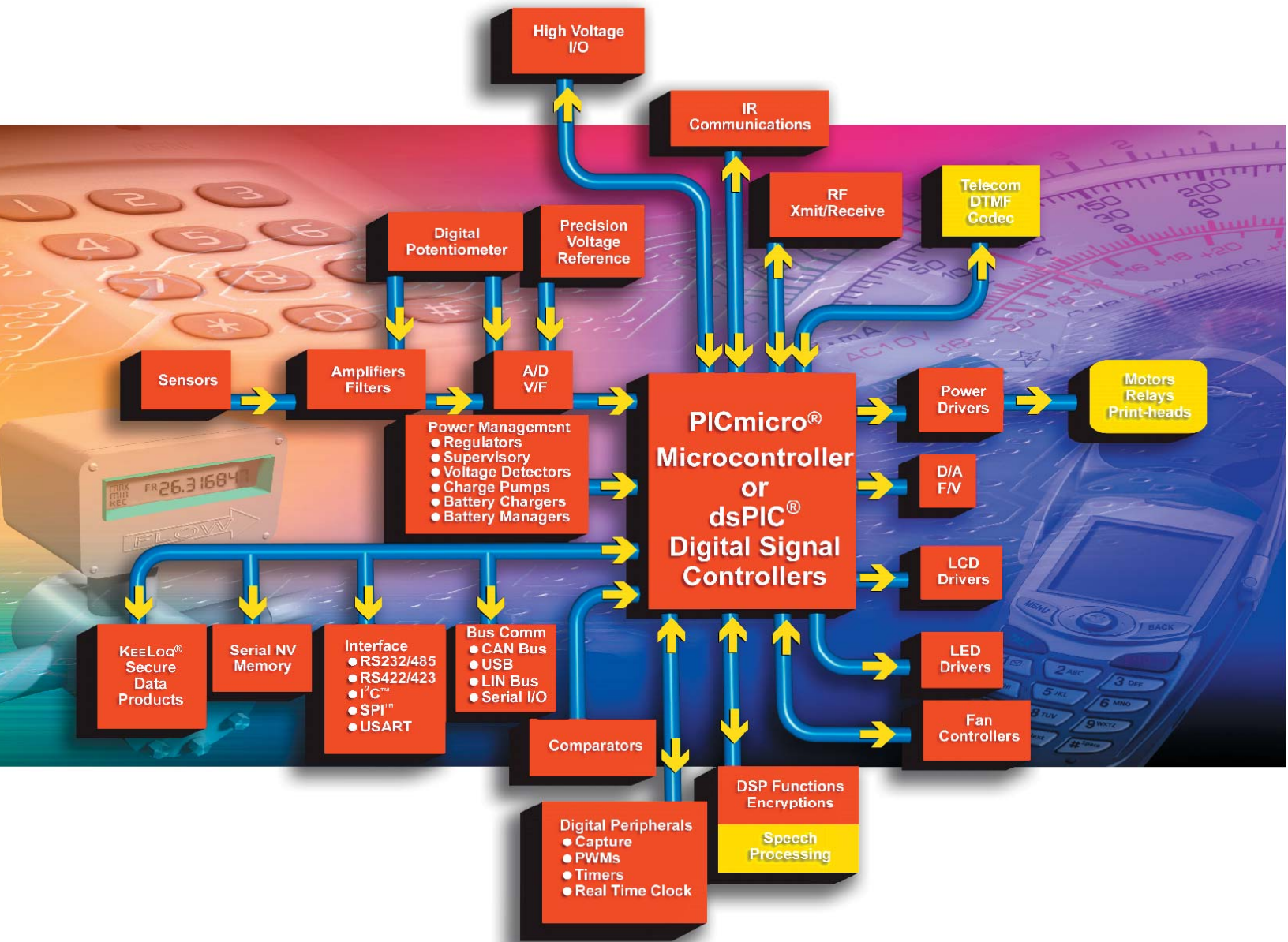

2004 Product Selector Guide



Product Profile

PICmicro® Microcontrollers

Microchip's PICmicro® family of microcontrollers combine high performance, low cost and small package size to offer the best price/performance ratio in the industry. Based on a powerful RISC core, the PICmicro architecture provides users an easy migration path from 8 to 84 pins among all families with little or no code change required. Advanced features available are:

- sophisticated timing peripherals
- embedded analog-to-digital converters (ADCs) and digital-to-analog converters (DACs)
- extended instruction/data memory
- communications peripherals (I²C™/SPI™/USB/CAN and USARTs)
- In-Circuit Serial Programming™ technology (ICSP™)
- memory technology including one-time programmable (OTP), reprogrammable (FLASH) and read-only memory (ROM)
- advanced analog features (PBOR, PLVD, DAC, VREF, Op Amps and PSMC)

Analog & Interface Products

Microchip offers a wide range of analog and related products:

- *Linear and Mixed-Signal.* ADCs/DACs, digital potentiometers, op amps and comparators.
- *Power Management.* LDO and switching regulators, charge pumps, voltage references, CPU/system supervisors and voltage detectors, battery chargers and power MOSFET drivers.
- *Thermal Management.* Temperature sensors (logic output, voltage output, and serial output), brushless DC fan controllers, and fan fault detectors.
- *Interface.* Peripheral products supporting industry-standard networking protocols like CAN, LIN and infrared (including IrDA® Standard infrared), as well as products that provide embedded system input/output expansion capability.

Secure Data Products

Microchip's KEELoQ® family of code hopping devices provides "rock solid" security for remote-keyless-entry (RKE) and authentication applications. Devices using the KEELoQ code hopping algorithm combine high security, a small package outline and a very low cost to make this an ideal solution for unidirectional RKE systems. The KEELoQ code hopping technology creates a high degree of security using a long code word length together with encryption and synchronization techniques.

Memory Products

- Microchip offers one of the broadest selections of serial EEPROMs in densities from 128 bits to 512 Kbits, with operating voltages down to 1.8V, in all popular bus protocols (I²C™, Microwire and SPI™ compatible). They are available in all standard temperature ranges from -40°C to +125°C and packaged in the world's smallest standard packaging; up to 16 Kbits in 5-lead SOT-23 and up to 256 Kbits in 8-lead MSOP. With high-speed buses, low power consumption, the highest E/W endurance and the longest data retention in the industry, Microchip's serial EEPROMs are used for virtually every application in the automotive, PC, consumer electronics, communications and industrial markets.

dsPIC® Digital Signal Controllers

The dsPIC® family of Digital Signal Controllers features a fully-implemented digital signal processor (DSP) engine, 30 MIPS non-pipe lined performance, C compiler friendly design, and a familiar microcontroller architecture and design environment. These 20 new dsPIC30FXXX 16-bit FLASH microcontrollers provide the industry's highest performance and target motor control and power conversion, sensor processing, and general-purpose applications.

rfPIC® Microcontrollers and rfHCS Devices

The rfPIC® family significantly eases the radio frequency (RF) design process while reducing component count and board space. The first devices feature an integrated 315/433 MHz ASK/FSK transmitter. These low-power single-chip RF solutions are the first of many planned devices in the new family which targets RF connectivity for high-volume embedded control applications, such as remote sensing, remote control, toys, security and access control.

Development Systems

Microchip offers a full range of microcontroller development systems, including the MPLAB® ICE 2000 and ICE 9000 in-circuit emulators; MPLAB Integrated Development Environment; MPLAB C18 and C30 Compiler; the MPLAB ICD In-Circuit Debugger, MPLAB PM3 full-featured device programmer; PICSTART® low-cost development system; the PICkit™ 1 Flash Starter Kit, SEEVAL® Serial EEPROM Evaluation Kit and various demonstration boards. Microchip has shipped more than 300,000+ development systems worldwide.

TABLE OF CONTENTS

CURRENT PICmicro® MICROCONTROLLER FAMILY PRODUCTS	6
PIC10FXXX	6
PIC12C/FXXX	6
PIC16C/F5X	6
PIC12FXXX	7
PIC16CXXX	7
PIC16FXXX	8
PIC18FXXX Flash MCUs	10
FOCUSED SOLUTIONS - PICmicro® MICROCONTROLLER FAMILY PRODUCTS	14
Connectivity Solutions	
CAN	14
USB	15
Ethernet	14
rfPIC® Microcontrollers with UHF RF Transmitter	15
rfHCS KEELOQ® Encoders with UHF RF Transmitter	15
UHF RF Receiver	15
LCD Solutions	16
Motor Control Solutions	17
Power Managed Solutions Featuring nanoWatt Technology	18
MATURE PICmicro® MICROCONTROLLER FAMILY PRODUCTS	19
BATTERY MANAGEMENT FAMILY PRODUCTS	20
Battery Fuel Gauge ICs	20
dsPIC® DIGITAL SIGNAL CONTROLLER (DSC) PRODUCTS	21
dsPIC30F Motor Control and Power Conversion Controller Family	21
dsPIC30F General Purpose Controller Family	21
dsPIC30F Sensor Family	21
RADIO FREQUENCY PRODUCTS	22
PASSIVE	22
microID® RFID Tagging Devices	22
SECURE DATA PRODUCTS	23
KEELOQ® Encoder Devices	23
KEELOQ® Decoder Devices	23
KEELOQ® Encoder/Decoder Devices	24
ANALOG/INTERFACE PRODUCTS	25
THERMAL MANAGEMENT PRODUCTS	25
Temperature Sensors	25
Brushless DC Fan Controllers and Fan Fault Detectors	26

POWER MANAGEMENT	27
Voltage References	27
Linear Regulators	27
Switching Regulators	30
PWM	31
Charge Pump DC-to-DC Converters	31
CPU/System Supervisors	32
Voltage Detectors	33
Power MOSFET Drivers	33
Battery Chargers	35
Hot Swap Controllers	35
LINEAR	35
Op Amps	35
High Precision Operational Amplifiers	37
Programmable Gain Amplifiers (PGA)	38
Integrated Devices	38
Comparators	38
MIXED SIGNAL	39
Successive Approximation Register (SAR) A/D Converters	39
Sigma-Delta A/D Converters	39
Dual Slope A/D Converters	39
Binary and BCD A/D Converters	40
Display A/D Converters	40
Digital Potentiometers	41
Frequency-to-Voltage/Voltage-to-Frequency Converters	41
System D/A Converters	42
INTERFACE	42
Controller Area Network (CAN) Products	42
Infrared Products	43
LIN Transceiver Products	43
Serial Peripherals	43
SERIAL ELECTRICALLY ERASABLE PROMS (EEPROM)	44
Microwire Compatible Serial EEPROM Family	44
2-Wire I ² C™ Compatible Serial EEPROM Family	45
ISO Smart Card Family	46
SPI™ Compatible Serial EEPROM Family	46
Identification Products	47

DEVELOPMENT SYSTEMS	48
MPLAB® ICE 2000 and MPLAB® ICE 4000 Emulator Systems	48
PRO MATE® II and MPLAB® PMS Programmers	48
In-Circuit Debuggers: MPLAB® ICD 2	48
MPLAB® ICE 2000 and MPLAB® ICE 4000 Emulator Systems, PRO MATE® II Programmer Socket Modules, MPLAB® In-Circuit Debugger, Software Tools, Programmers and Demonstration Boards . . .	49
Analog Interface Development Tools	49
PICmicro® Microcontroller Development Tools	49
rfPIC® Microcontroller Development Tools	68
dsPIC™ Microcontroller Development Tools	69
Demonstration Boards and Evaluation Kits	71
PICmicro® Demonstration Kits	71
Connectivity Demonstration Kits	71
Mixed Signal Control Demonstration Kits	72
dsPIC™ 16-bit MCU/DSP Demonstration Kits	72
dsPIC™ 16-bit MCU/DSP Software Tools	72
PowerSmart® Development Systems	73
Memory Evaluation/Developer's Kits	73
KEELOQ® Evaluation Kits	74
Analog Evaluation/Developer's Kits	74
Analog Evaluation Kits	74
Thermal Management Tools	74
Data Converter Tools	74
RFID Evaluation/Developer's Kits	74
FUTURE MICROCHIP PRODUCTS	75
BASELINE 8-BIT PICmicro® MICROCONTROLLER (MCU) PRODUCTS	75
PIC12FXXX	75
PIC16FXXX	75
MID-RANGE 8-BIT PICmicro® MICROCONTROLLER FAMILY	75
PIC16FXXX	75
HIGH PERFORMANCE 8-BIT PICmicro® MICROCONTROLLER FAMILY	76
PIC18FXXX	76
BATTERY MANAGEMENT FAMILY PRODUCTS	77
Switching Battery Chargers	77
Battery Fuel Gauge ICs	77
dsPIC® DIGITAL SIGNAL CONTROLLER (DSC) PRODUCTS	77
dsPIC30F Motor Control and Power Conversion Controller Family	77
SERIAL ELECTRICALLY ERASABLE PROMS (EEPROM)	78
SPI™ Compatible Serial EEPROM Family	78

ANALOG/INTERFACE PRODUCTS	78
Thermal Management	78
Voltage Output Temperature Sensors	78
Power Management	79
Switching Regulators	79
Battery Chargers	79
Linear	79
Operational Amplifiers	79
Linear Gain Blocks	79
Mixed Signal	80
Delta-Sigma A/D Converters	80
Interface	80
Infrared Products	80
PIN AND CODE COMPATIBILITY CHART	81
PACKAGE PHOTOS	85
PART NUMBER SUFFIX DESIGNATIONS	87
ABBREVIATIONS	90

PICmicro[®] MICROCONTROLLER FAMILIES

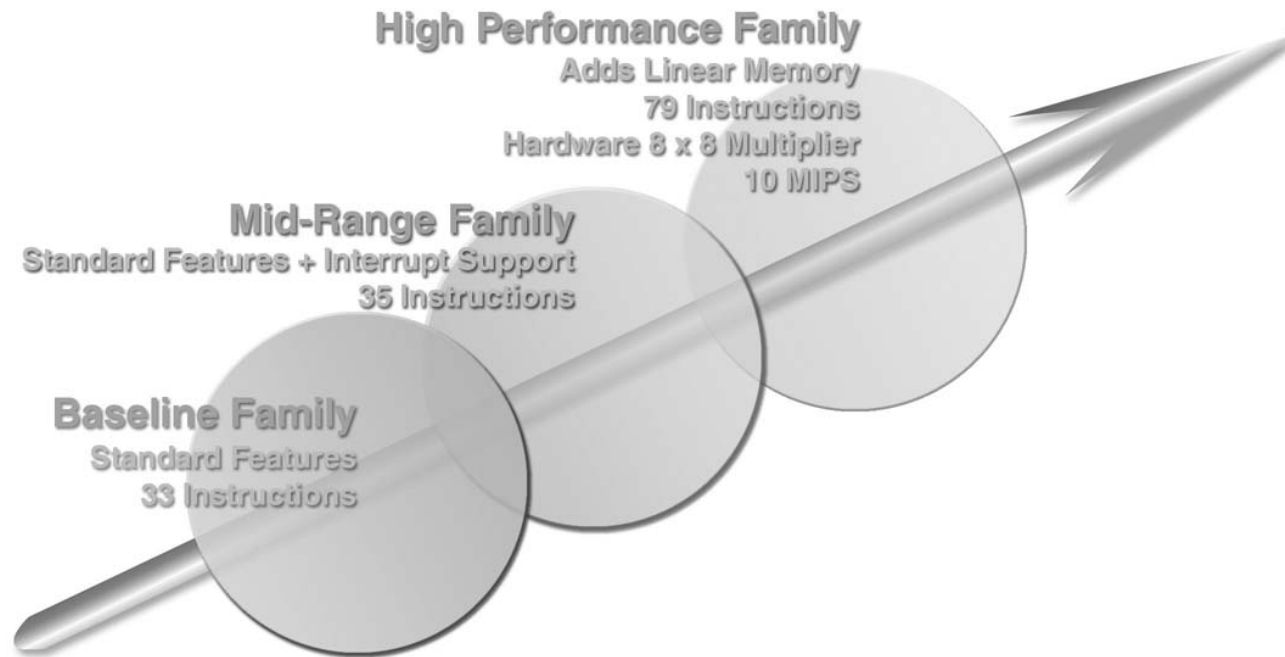

Baseline Product Family:

The Baseline product family is comprised of the PIC10 family and portions of the PIC12 and PIC16 families. These devices utilize a 12-bit program word architecture with 6- to 28-pin package options.

Mid-Range Product Family:

The Mid-Range product family is comprised of portions of the PIC12 and PIC16 families. These devices feature a 14-bit program word architecture with 8- to 64-pin package options.

High Performance Product Family:

The High Performance product family features the PIC18 family of devices. These microcontrollers utilize a 16-bit program word architecture with 18- to 80-pin package options.

CURRENT MICROCONTROLLER FAMILY PRODUCTS

Baseline 8-Bit PICmicro® Microcontroller Family														
Product	Program Memory (Bytes)	RAM Bytes	I/O Pins	Packages	Analog		Digital	Max. Speed MHz	IntOSC	ICSP™	BOR/PBOR/PLVD	ICD # of Breakpoints	Operating Voltage (V)	Other Features
					ADC	Comp.	Timers/WDT							
PIC10FXXX: 200 ns Instruction Execution, 33 Instructions														
PIC10F200	384 StdFI	16	4	6OT, 8P	—	—	1-8 bit, 1-WDT	4	4 MHz	✓	—	1**	2.0 - 5.5	
PIC10F202	768 StdFI	24	4	6OT, 8P	—	—	1-8 bit, 1-WDT	4	4 MHz	✓	—	1**	2.0 - 5.5	
PIC10F204	384 StdFI	16	4	6OT, 8P	—	1	1-8 bit, 1-WDT	4	4 MHz	✓	—	1**	2.0 - 5.5	Bandgap reference
PIC10F206	768 StdFI	24	4	6OT, 8P	—	1	1-8 bit, 1-WDT	4	4 MHz	✓	—	1**	2.0 - 5.5	Bandgap reference
PIC12C/FXXX (x12): 1 µs Instruction Execution, 33 Instructions, 4 Oscillator Selections														
PIC12C508A	768 OTP	25	6	8P, 8SM, 8JW, 8SN, 8MF	—	—	1-8 bit, 1-WDT	4	4 MHz	✓	—	—	2.5 - 5.5	
PIC12C509A	1536 OTP	41	6	8P, 8SM, 8JW, 8SN, 8MF	—	—	1-8 bit, 1-WDT	4	4 MHz	✓	—	—	2.5 - 5.5	
PIC12F508	768 StdFI	25	6	8P, 8SN, 8MS	—	—	1-8 bit, 1-WDT	4	4 MHz	✓	—	1**	2.0 - 5.5	
PIC12F509	1536 StdFI	41	6	8P, 8SN, 8MS	—	—	1-8 bit, 1-WDT	4	4 MHz	✓	—	1**	2.0 - 5.5	
PIC16C/F5X (x12): Upwardly Compatible with PIC16C5X/PIC12CXXX, 100-200 ns Instruction Execution, 33/35 Instructions, 4/5 Oscillator Selections														
PIC16C55A	768 OTP	24	20	28P, 28JW, 28SP, 28SO, 28SS	—	—	1-8 bit, 1-WDT	40	—	—	—	—	2.5 - 5.5	
PIC16C56A	1536 OTP	25	12	18P, 18JW, 18SO, 20SS	—	—	1-8 bit, 1-WDT	40	—	—	—	—	2.5 - 5.5	
PIC16CR56A	1536 ROM	25	12	18P, 18SO, 20SS	—	—	1-8 bit, 1-WDT	20	—	—	—	—	2.5 - 5.5	
PIC16C58B	3072 OTP	73	12	18P, 18JW, 18SO, 20SS	—	—	1-8 bit, 1-WDT	40	—	—	—	—	2.5 - 5.5	
PIC16CR58B	3072 ROM	73	12	18P, 18SO, 20SS	—	—	1-8 bit, 1-WDT	20	—	—	—	—	2.5 - 5.5	
PIC16HV540	768 OTP	25	12	18P, 18JW, 18SO, 20SS	—	—	1-8 bit, 1-WDT	20	—	—	BOR	—	3.5 - 15	8 high-voltage (15V) I/Os, 4 deep stack, 5 I/Os with wake-up-on-change
PIC16F505	1536 StdFI	72	12	14P, 14JW, 14SL	—	—	1-8 bit, 1-WDT	20	4 MHz	✓	—	1**	2.0 - 5.5	
PIC16F54	768 StdFI	25	12	18P, 18SO, 20SS	—	—	1-8 bit, 1-WDT	20	—	✓	—	—	2.0 - 5.5	
PIC16F57	3072 StdFI	72	20	28P, 28SO, 28SS, 28SP	—	—	1-8 bit, 1-WDT	20	—	✓	—	—	2.0 - 5.5	
PIC16F59	3072 StdFI	134	32	40P, 44PT	—	—	1-8 bit, 1-WDT	20	—	✓	—	—	2.0 - 5.5	

*Contact Microchip Technology for availability date.

** Requires ICD specific device with header module – refer to Development Tools.

Mid-Range 8-Bit PICmicro® Microcontroller Family

Product	Program Memory (Bytes)	EEPROM Data Memory Bytes	RAM Bytes	I/O Pins	Packages	Analog		Digital		Max. Speed MHz	IntOSC	BOR/PBOR/PLVD	ICD # of Breakpoints	CCP/ECCP	nW	Other Features
						ADC Ch	Comp.	Timers/WDT	Serial I/O							
PIC12FXXX (x14): Upwardly Compatible with PIC12CXXX, 200 ns – 1 µs Instruction Execution, 35 Instructions, 4/5 Oscillator Selections, ICSP™																
PIC12F629	1792 StdFI	128	64	6	8P, 8SN, 8MF	—	1	1-8 bit, 1-16 bit, 1-WDT	—	20	4 MHz	BOR	1**	—	—	
PIC12F635	1792 StdFI	128	64	6	8P, 8SN, 8MF	—	1	1-8 bit, 1-16 bit, 1-WDT	—	20	8 MHz	BOR/PLVD	1**	—	✓	KEELOQ® Functionality
PIC12F675	1792 StdFI	128	64	6	8P, 8SN, 8MF	4x10-bit	1	1-8 bit, 1-16 bit, 1-WDT	—	20	4 MHz	BOR	1**	—	—	
PIC12F683	3584 StdFI	256	128	6	8P, 8SN, 8MF	4x10-bit	1	1-16 bit, 2-8 bit, 1-WDT	—	20	8 MHz	BOR	1**	1/0	✓	
PIC16CXXX (x14): Upwardly Compatible with PIC16C5X/PIC12CXXX, 4-12 Interrupts, 100-200 ns Instruction Executions, 35 Instructions, 4/5 Oscillator Selections, ICSP™ (except ROM)																
PIC14000	7168 OTP	—	192	20	28SP, 28SO, 28SS, 28JW	8 SLAC	2	1-8 bit, 1-16 bit, 1-WDT	I ² C™/SMB	20	4 MHz	—	—	—	—	Temperature Sensor, Prog. Reference Generator
PIC16C432	3584 OTP	—	128	12	20SS, 20P, 20JW	—	2	1-8 bit, 1-WDT	LIN	20	—	BOR	—	—	—	LIN XCVR, 18V/40 mA
PIC16C433	3584 OTP	—	128	6	18SO, 18P, 18JW	4x8-bit	—	1-8 bit, 1-WDT	LIN	10	4 MHz	—	—	—	—	LIN XCVR, 18V/40 mA
PIC16C554	896 OTP	—	80	13	18P, 18SO, 18JW, 20SS	—	—	1-8 bit, 1-WDT	—	20	—	—	—	—	—	
PIC16C558	3584 OTP	—	128	13	18P, 18SO, 18JW, 20SS	—	—	1-8 bit, 1-WDT	—	20	—	—	—	—	—	
PIC16C62B	3584 OTP	—	128	22	28SP, 28SO, 28SS, 28JW, 28ML	—	—	1-16 bit, 2-8 bit, 1-WDT	I ² C/SPI™	20	—	BOR	—	1/0	—	
PIC16C620A	896 OTP	—	96	13	18P, 18SO, 18JW, 20SS	—	2	1-8 bit, 1-WDT	—	40	—	BOR	—	—	—	
PIC16CR620A	896 OTP	—	96	13	18P, 18SO, 20SS	—	2	1-8 bit, 1-WDT	—	20	—	BOR	—	—	—	
PIC16C621A	1792 OTP	—	96	13	18P, 18SO, 18JW, 20SS	—	2	1-8 bit, 1-WDT	—	40	—	BOR	—	—	—	
PIC16C622A	3584 OTP	—	128	13	18P, 18SO, 18JW, 20SS	—	2	1-8 bit, 1-WDT	—	40	—	BOR	—	—	—	
PIC16C63A	7168 OTP	—	192	22	28SP, 28SO, 28SS, 28JW, 28ML	—	—	1-16 bit, 2-8 bit, 1-WDT	USART, I ² C/SPI	20	—	BOR	—	2/0	—	
PIC16CR63	7168 OTP	—	192	22	28SP, 28SO, 28SS	—	—	1-16 bit, 2-8 bit, 1-WDT	USART, I ² C/SPI	20	—	BOR	—	2/0	—	
PIC16C65B	7168 OTP	—	192	33	40P, 40JW, 44L, 44PQ, 44PT	—	—	1-16 bit, 2-8 bit, 1-WDT	USART, I ² C/SPI	20	—	BOR	—	2/0	—	PSP
PIC16CR65	7168 OTP	—	192	33	40P, 44L, 44PQ, 44PT	—	—	1-16 bit, 2-8 bit, 1-WDT	USART, I ² C/SPI	20	—	BOR	—	2/0	—	PSP
PIC16C717	3584 OTP	—	256	16	18P, 18SO, 18JW, 20SS	6x10-bit	—	1-16 bit, 2-8 bit, 1-WDT	M ² C/SPI	20	4 MHz	PBOR/PLVD	—	0/1	—	
PIC16C72A	3584 OTP	—	128	22	28SP, 28SO, 28JW, 28SS, 28ML	5x8-bit	—	1-16 bit, 2-8 bit, 1-WDT	I ² C/SPI	20	—	BOR	—	1/0	—	
PIC16CR72	3584 OTP	—	128	22	28SP, 28SO, 28SS	5x8-bit	—	1-16 bit, 2-8 bit, 1-WDT	I ² C/SPI	20	—	BOR	—	1/0	—	
PIC16C73B	7168 OTP	—	192	22	28SP, 28SO, 28JW, 28SS, 28ML	5x8-bit	—	1-16 bit, 2-8 bit, 1-WDT	USART, I ² C/SPI	20	—	BOR	—	2/0	—	
PIC16C74B	7168 OTP	—	192	33	40P, 40JW, 44L, 44PQ, 44PT	8x8-bit	—	1-16 bit, 2-8 bit, 1-WDT	USART, I ² C/SPI	20	—	BOR	—	2/0	—	PSP
PIC16C745	14336 OTP	—	256	22	28SP, 28SO, 28JW	5x8-bit	—	1-16 bit, 2-8 bit, 1-WDT	USART, low speed USB	24	—	BOR	—	2/0	—	USB 1.1, 64 bytes dual port RAM

Mid-Range 8-Bit PICmicro® Microcontroller Family																
Product	Program Memory (Bytes)	EEPROM Data Memory Bytes	RAM Bytes	I/O Pins	Packages	Analog		Digital		Max. Speed MHz	IntOSC	BOR/PBOR/PLVD	ICD # of Breakpoints	CCP/ECCP	nW	Other Features
						ADC Ch	Comp.	Timers/WDT	Serial I/O							
PIC16CXXX (x14): Upwardly Compatible with PIC16C5X/PIC12CXXX, 4-12 Interrupts, 100-200 ns Instruction Executions, 35 Instructions, 4/5 Oscillator Selections, ICSP™ (except ROM) (continued)																
PIC16C765	14336 OTP	—	256	33	40P, 40JW, 44L, 44PT	8x8-bit	—	1-16 bit, 2-8 bit, 1-WDT	USART, low speed USB	24	—	BOR	—	2/0	—	USB 1.1, 64 bytes dual port RAM, PSP
PIC16C770	3584 OTP	—	256	16	20P, 20SO, 20JW, 20SS	6x12-bit	—	1-16 bit, 2-8 bit, 1-WDT	M ² C/SPI	20	4 MHz	PBOR/PLVD	—	0/1	—	
PIC16C771	7168 OTP	—	256	16	20P, 20SO, 20JW, 20SS	6x12-bit	—	1-16 bit, 2-8 bit, 1-WDT	M ² C/SPI	20	4 MHz	PBOR/PLVD	—	0/1	—	
PIC16C773	7168 OTP	—	256	22	28SP, 28SO, 28SS, 28JW	6x12-bit	—	1-16 bit, 2-8 bit, 1-WDT	AUSART, M ² C/SPI	20	—	PBOR/PLVD	—	2/0	—	
PIC16C774	7168 OTP	—	256	33	40P, 40JW, 44L, 44PQ, 44PT	10x12-bit	—	1-16 bit, 2-8 bit, 1-WDT	AUSART, M ² C/SPI	20	—	PBOR/PLVD	—	2/0	—	PSP
PIC16C781	1792 OTP	—	128	16	20P, 20SO, 20SS, 20JW	8x8-bit	2	1-16 bit, 2-8 bit, 1-WDT	—	20	4 MHz	PBOR	—	—	—	Op Amp, PSMC, DAC
PIC16C782	3584 OTP	—	128	16	20P, 20SO, 20SS, 20JW	8x8-bit	2	1-16 bit, 2-8 bit, 1-WDT	—	20	4 MHz	PBOR/PLVD	—	—	—	Op Amp, PSMC, DAC
PIC16C925	7168 OTP	—	176	52	68CL, 68L, 64PT	5x10-bit	—	1-16 bit, 2-8 bit, 1-WDT	I ² C/SPI	20	—	BOR	—	1/0	—	LCD module, static, 1/2, 1/3, 1/4 multiplex
PIC16C926	14336 OTP	—	336	52	68CL, 68L, 64PT	5x10-bit	—	1-16 bit, 2-8 bit, 1-WDT	I ² C/SPI	20	—	BOR	—	1/0	—	LCD module, static, 1/2, 1/3, 1/4 multiplex
PIC16FXXX (x14): Migration to PIC16CXXX/PIC16C5X/PIC12CXXX, 17 Interrupts, 200 ns Instruction Execution, 33/35 Instructions, 4 Oscillator Selections, ICSP™ (except ROM)																
PIC16F627A	1792 StdFI	128	224	16	18P, 18SO, 20SS, 28ML	—	2	1-16 bit, 2-8 bit, 1-WDT	AUSART	20	4 MHz	BOR	1**	1/0	✓	
PIC16F628A	3584 StdFI	128	224	16	18P, 18SO, 20SS, 28ML	—	2	1-16 bit, 2-8 bit, 1-WDT	AUSART	20	4 MHz	BOR	1**	1/0	✓	
PIC16F630	1792 StdFI	128	64	12	14P, 14SL, 14ST	—	1	1-8 bit, 1-16 bit, 1-WDT	—	20	4 MHz	BOR	1**	—	—	
PIC16F636	3584 StdFI	256	128	12	14P, 14SL, 14ST	—	2	1-8 bit, 1-16 bit, 1-WDT	—	20	8 MHz	BOR/PLVD	1**	—	✓	KEELOQ® Functionality
PIC16F684	3584 StdFI	256	128	12	14P, 14SL, 14ST	8x10-bit	2	1-16 bit, 2-8 bit, 1-WDT	—	20	8 MHz	BOR	1**	0/1	✓	
PIC16F648A	7168 StdFI	256	256	16	18P, 18SO, 20SS, 28ML	—	2	1-16 bit, 2-8 bit, 1-WDT	AUSART	20	4 MHz	BOR	1**	1/0	✓	
PIC16F676	1792 StdFI	128	64	12	14P, 14SL, 14ST	8x10-bit	1	1-8 bit, 1-16 bit, 1-WDT	—	20	4 MHz	BOR	1**	—	—	
PIC16F688	7168 StdFI	256	256	12	14P, 14SL, 14ST	8x10-bit	2	1-8 bit, 1-16 bit, 1-WDT	EUSART	20	8 MHz	BOR	1**	—	✓	
PIC16F716	3584 StdFI	—	128	13	18P, 18SO, 20SS	4x8-bit	—	1-16 bit, 2-8 bit, 1-WDT	—	20	—	BOR	1**	0/1	—	
PIC16F72	3584 StdFI	—	128	22	28SP, 28SO, 28SS, 28ML	5x8-bit	—	1-16 bit, 2-8 bit, 1-WDT	I ² C/SPI	20	—	BOR	—	1/0	—	
PIC16F73	7168 StdFI	—	192	22	28SP, 28SO, 28SS, 28ML	5x8-bit	—	1-16 bit, 2-8 bit, 1-WDT	USART, I ² C/SPI	20	—	BOR	—	2/0	—	
PIC16F737	7168 StdFI	—	368	25	28SP, 28SO, 28SS, 28ML	11x10-bit	2	1-16 bit, 2-8 bit, 1-WDT	AUSART, M ² C/SPI	20	8 MHz	PBOR/PLVD	1	3/0	✓	
PIC16F74	7168 StdFI	—	192	33	40P, 44ML, 44L, 44PT	8x8-bit	—	1-16 bit, 2-8 bit, 1-WDT	USART, I ² C/SPI	20	—	BOR	—	2/0	—	PSP

Mid-Range 8-Bit PICmicro® Microcontroller Family

Product	Program Memory (Bytes)	EEPROM Data Memory Bytes	RAM Bytes	I/O Pins	Packages	Analog		Digital		Max. Speed MHz	IntOSC	BOR/PBOR/PLVD	ICD # of Breakpoints	CCP/ECCP	nW	Other Features
						ADC Ch	Comp.	Timers/WDT	Serial I/O							
PIC16FXXX (x14): Migration to PIC16CXXX/PIC16C5X/PIC12CXXX, 17 Interrupts, 200 ns Instruction Execution, 33/35 Instructions, 4 Oscillator Selections, ICSP™ (except ROM) (continued)																
PIC16F747	7168 StdFI	—	368	36	40P, 44PT, 44ML	14x10-bit	2	1-16 bit, 2-8 bit, 1-WDT	AUSART, MI ² C/SPI	20	8 MHz	PBOR/PLVD	1	3/0	✓	PSP
PIC16F76	14336 StdFI	—	368	22	28SP, 28SO, 28SS, 28ML	5x8-bit	—	1-16 bit, 2-8 bit, 1-WDT	USART, I ² C/SPI	20	—	BOR	—	2/0	—	
PIC16F767	14336 StdFI	—	368	25	28SP, 28SO, 28SS, 28ML	11x10-bit	2	1-16 bit, 2-8 bit, 1-WDT	AUSART, MI ² C/SPI	20	8 MHz	PBOR/PLVD	1	3/0	✓	
PIC16F77	14336 StdFI	—	368	33	40P, 44ML, 44L, 44PT	8x8-bit	—	1-16 bit, 2-8 bit, 1-WDT	USART, I ² C/SPI	20	—	BOR	—	2/0	—	PSP
PIC16F777	14336 StdFI	—	368	36	40P, 44PT, 44ML	14x10-bit	2	1-16 bit, 2-8 bit, 1-WDT	AUSART, MI ² C/SPI	20	8 MHz	PBOR/PLVD	1	3/0	✓	PSP
PIC16F818	1792 EnhFI	128	128	16	18P, 18SO, 20SS, 28ML	5x10-bit	—	1-16 bit, 2-8 bit, 1-WDT	I ² C/SPI	20	8 MHz	BOR	1	1/0	✓	
PIC16F819	3584 EnhFI	256	256	16	18P, 18SO, 20SS, 28ML	5x10-bit	—	1-16 bit, 2-8 bit, 1-WDT	I ² C/SPI	20	8 MHz	BOR	1	1/0	✓	
PIC16F84A	1792 StdFI	64	68	13	18P, 18SO, 20SS	—	—	1-8 bit, 1-WDT	—	20	—	—	—	—	—	
PIC16F87	7168 EnhFI	256	368	16	18P, 18SO, 20SS, 28ML	—	2	1-16 bit, 2-8 bit, 1-WDT	AUSART, I ² C/SPI	20	8 MHz	BOR	1	1/0	✓	
PIC16F870	3584 EnhFI	64	128	22	28SP, 28SO, 28SS	5x10-bit	—	1-16 bit, 2-8 bit, 1-WDT	AUSART	20	—	BOR	1	1/0	—	
PIC16F871	3584 EnhFI	64	128	33	40P, 44L, 44PT	8x10-bit	—	1-16 bit, 2-8 bit, 1-WDT	AUSART	20	—	BOR	1	1/0	—	PSP
PIC16F872	3584 EnhFI	64	128	22	28SP, 28SO, 28SS	5x10-bit	—	1-16 bit, 2-8 bit, 1-WDT	MI ² C/SPI	20	—	BOR	1	1/0	—	
PIC16F873A	7168 EnhFI	128	192	22	28SP, 28SO, 28SS, 28ML	5x10-bit	2	1-16 bit, 2-8 bit, 1-WDT	AUSART, MI ² C/SPI	20	—	BOR	1	2/0	—	
PIC16F874A	7168 EnhFI	128	192	33	40P, 44ML, 44L, 44PT	8x10-bit	2	1-16 bit, 2-8 bit, 1-WDT	AUSART, MI ² C/SPI	20	—	BOR	1	2/0	—	PSP
PIC16F876A	14336 EnhFI	256	368	22	28SP, 28SO, 28SS, 28ML	5x10-bit	2	1-16 bit, 2-8 bit, 1-WDT	AUSART, MI ² C/SPI	20	—	BOR	1	2/0	—	
PIC16F877A	14336 EnhFI	256	368	33	40P, 44ML, 44L, 44PT	8x10-bit	2	1-16 bit, 2-8 bit, 1-WDT	AUSART, MI ² C/SPI	20	—	BOR	1	2/0	—	PSP
PIC16F88	7168 EnhFI	256	368	16	18P, 18SO, 20SS, 28ML	7x10-bit	2	1-16 bit, 2-8 bit, 1-WDT	AUSART, I ² C/SPI	20	8 MHz	BOR	1	1/0	✓	

*Contact Microchip Technology for availability date.

** Requires ICD specific device with header module – refer to Development Tools.

High Performance 8-Bit PICmicro® Microcontroller Family																
Product	Program Memory (Bytes)	EEPROM Data Memory Bytes	RAM Bytes	I/O Pins	Packages	Analog		Digital		Max. Speed MHz	IntOSC	BOR/PLVD	ICD # of Breakpoints	CCP/ECCP	nW	Other Features
						ADC Ch	Comp.	Timers/WDT	Serial I/O							
PIC18FXXX Flash MCUs (x16): Upwardly Compatible with PIC18CXXX/PIC17C7XX/PIC16CXX/PIC16C5X/PIC12CXXX, 77 Instructions, C Compiler Efficient Instruction Set, Software Stack Capability, Table Read/Write, 10 MIPS, 4x PLL, Switchable Oscillator Sources, 25 mA Source/Sink per I/O, ICSP™ (except ROM)																
PIC18C601	ROM-less	—	1536	26	64PT, 68L	8x10-bit	—	3-16 bit, 1-8 bit, 1-WDT	AUSART, Mi ² C/SPI	25	—	—	—	2/0	—	256KB EMA, Bootloader RAM
PIC18C801	ROM-less	—	1536	37	80PT, 84L	12x10-bit	—	3-16 bit, 1-8 bit, 1-WDT	AUSART, Mi ² C/SPI	25	—	—	—	2/0	—	2MB EMA, Bootloader RAM
PIC18F1220	4096 EnhFI	256	256	16	18P, 18SO, 20SS, 28ML	7x10-bit	—	3-16 bit, 1-8 bit, 1-WDT	EUSART	40	8 MHz	PBOR/PLVD	1	0/1	✓	
PIC18F1320	8192 EnhFI	256	256	16	18P, 18SO, 20SS, 28ML	7x10-bit	—	3-16 bit, 1-8 bit, 1-WDT	EUSART	40	8 MHz	PBOR/PLVD	1	0/1	✓	
PIC18F2220	4096 EnhFI	256	512	25	28SP, 28SO	10x10-bit	2	3-16 bit, 1-8 bit, 1-WDT	AUSART, Mi ² C/SPI	40	8 MHz	PBOR/PLVD	1	2/0	✓	
PIC18F2320	8192 EnhFI	256	512	25	28SP, 28SO	10x10-bit	2	3-16 bit, 1-8 bit, 1-WDT	AUSART, Mi ² C/SPI	40	8 MHz	PBOR/PLVD	1	2/0	✓	
PIC18F2331	8192 EnhFI	256	768	24	28SP, 28SO	5x10-bit, 200 ksps	—	3-16 bit, 1-8 bit, 1-WDT	EUSART, I ² C/SPI	40	8 MHz	PBOR/PLVD	1	2/0	—	6 14-bit Motor Control PWMs, 2-ch Quadrature Encoder
PIC18F2410	16384 StdFI	—	768	25	28SP, 28SO, 28ML	10x10-bit	2	3-16 bit, 1-8 bit, 1-WDT	EUSART, Mi ² C/SPI	40	8 MHz	PBOR/PLVD	3	2/0	✓	
PIC18F2420	16384 EnhFI	256	768	25	28SP, 28SO, 28ML	10x10-bit	2	3-16 bit, 1-8 bit, 1-WDT	EUSART, Mi ² C/SPI	40	8 MHz	PBOR/PLVD	3	2/0	✓	
PIC18F2431	16384 EnhFI	256	768	24	28SP, 28SO	5x10-bit, 200 ksps	—	3-16 bit, 1-8 bit, 1-WDT	EUSART, I ² C/SPI	40	8 MHz	PBOR/PLVD	1	2/0	—	6 14-bit Motor Control PWMs, 2-ch Quadrature Encoder
PIC18F2439	12288 EnhFI	256	640	21	28SP, 28SO	5x10-bit	—	3-16 bit, 1-8 bit, 1-WDT	AUSART, Mi ² C/SPI	40	—	PBOR/PLVD	1	—	—	Motor Control Kernel
PIC18F2455*	24576 EnhFI	256	2048	24	28SP, 28SO	11x10-bit	2	3-16 bit, 1-8 bit, 1-WDT	USB 2.0, Mi ² C/SPI, EUSART	48	8 MHz	PBOR/PLVD	3	1/1	✓	Full Speed USB 2.0 Compliant
PIC18F248	16384 EnhFI	256	768	23	28SP, 28SO	5x10-bit	—	3-16 bit, 1-8 bit, 1-WDT	AUSART, Mi ² C/SPI, CAN 2.0B	40	—	PBOR/PLVD	1	1/0	—	Full CAN 2.0B, 3 transmit buffers, 2 receive buffers, 6 acceptable filters, 2 filter masks
PIC18F2480*	16384 EnhFI	256	768	25	28SP, 28SO, 28ML	8x10-bit	—	3-16 bit, 1-8 bit, 1-WDT	CAN 2.0B, Mi ² C/SPI, EUSART	40	8 MHz	PBOR/PLVD	3	1/0	✓	ECAN
PIC18F2510	32768 StdFI	—	1536	25	28SP, 28SO, 28ML	10x10-bit	2	3-16 bit, 1-8 bit, 1-WDT	EUSART, Mi ² C/SPI	40	8 MHz	PBOR/PLVD	3	2/0	✓	
PIC18F2515	49152 StdFI	—	3968	25	28SP, 28SO	10x10-bit	2	3-16 bit, 1-8 bit, 1-WDT	EUSART, Mi ² C/SPI	40	8 MHz	PBOR/PLVD	3	2/0	✓	
PIC18F2520	32768 EnhFI	256	1536	25	28SP, 28SO, 28ML	10x10-bit	2	3-16 bit, 1-8 bit, 1-WDT	EUSART, Mi ² C/SPI	40	8 MHz	PBOR/PLVD	3	2/0	✓	
PIC18F2525	49152 EnhFI	1024	3968	25	28SP, 28SO	10x10-bit	2	3-16 bit, 1-8 bit, 1-WDT	EUSART, Mi ² C/SPI	40	8 MHz	PBOR/PLVD	3	2/0	✓	
PIC18F2539	24576 EnhFI	256	1408	21	28SP, 28SO	5x10-bit	—	3-16 bit, 1-8 bit, 1-WDT	EUSART, Mi ² C/SPI	40	—	PBOR/PLVD	1	—	—	Motor Control Kernel

High Performance 8-Bit PICmicro® Microcontroller Family

Product	Program Memory (Bytes)	EEPROM Data Memory Bytes	RAM Bytes	I/O Pins	Packages	Analog		Digital		Max. Speed MHz	IntOSC	BOR/PBOR/PLVD	ICD # of Breakpoints	CCP/ECCP	nW	Other Features
						ADC Ch	Comp.	Timers/WDT	Serial I/O							
PIC18FXXX Flash MCUs (x16): Upwardly Compatible with PIC18CXXX/PIC17C7XX/PIC16CXX/PIC16C5X/PIC12CXXX, 77 Instructions, C Compiler Efficient Instruction Set, Software Stack Capability, Table Read/Write, 10 MIPS, 4x PLL, Switchable Oscillator Sources, 25 mA Source/Sink per I/O, ICSP™ (except ROM) (continued)																
PIC18F2550*	32768 EnhFI	256	2048	24	28SP, 28SO	11x10-bit	2	3-16 bit, 1-8 bit, 1-WDT	USB 2.0, MI ² C/SPI, EUSART	48	8 MHz	PBOR/PLVD	3	1/1	✓	Full Speed USB 2.0 Compliant
PIC18F258	32768 EnhFI	256	1536	23	28SP, 28SO	5x10-bit	—	3-16 bit, 1-8 bit, 1-WDT	AUSART, MI ² C/SPI, CAN 2.0B	40	—	PBOR/PLVD	1	1/0	—	Full CAN 2.0B, 3 transmit buffers, 2 receive buffers, 6 acceptance filters, 2 filter masks
PIC18F2580*	32768 EnhFI	256	1536	25	28SP, 28SO, 28ML	8x10-bit	—	3-16 bit, 1-8 bit, 1-WDT	CAN 2.0B, MI ² C/SPI, EUSART	40	8 MHz	PBOR/PLVD	3	1/0	✓	ECAN
PIC18F2585	49152 EnhFI	1024	3328	25	28SP, 28SO	8x10-bit	—	3-16 bit, 1-8 bit, 1-WDT	EUSART, MI ² C/SPI	40	8 MHz	PBOR/PLVD	3	1/0	—	ECAN
PIC18F2610	65536 StdFI	—	3968	25	28SP, 28SO	10x10-bit	2	3-16 bit, 1-8 bit, 1-WDT	EUSART, MI ² C/SPI	40	8 MHz	PBOR/PLVD	3	2/0	✓	
PIC18F2620	65536 EnhFI	1024	3968	25	28SP, 28SO	10x10-bit	2	3-16 bit, 1-8 bit, 1-WDT	EUSART, MI ² C/SPI	40	8 MHz	PBOR/PLVD	3	2/0	✓	
PIC18F2680	65536 EnhFI	1024	3328	25	28SP, 28SO	8x10-bit	—	3-16 bit, 1-8 bit, 1-WDT	CAN 2.0B, MI ² C/SPI, EUSART	40	8 MHz	PBOR/PLVD	3	1/0	—	ECAN
PIC18F4220	4096 EnhFI	256	512	36	40P, 44ML, 44PT	13x10-bit	2	3-16 bit, 1-8 bit, 1-WDT	AUSART, MI ² C/SPI	40	8 MHz	PBOR/PLVD	1	1/1	✓	PSP
PIC18F4320	8192 EnhFI	256	512	36	40P, 44ML, 44PT	13x10-bit	2	3-16 bit, 1-8 bit, 1-WDT	AUSART, MI ² C/SPI	40	8 MHz	PBOR/PLVD	1	1/1	✓	PSP
PIC18F4331	8192 EnhFI	256	768	36	40P, 44ML, 44PT	9x10-bit 200 ksps	—	3-16 bit, 1-8 bit, 1-WDT	EUSART, I ² C/SPI	40	8 MHz	PBOR/PLVD	1	2/0	—	8 14-bit Motor Control PWMs, 2-ch Quadrature Encoder
PIC18F4410	16384 StdFI	—	768	36	40P, 44ML, 44PT	13x10-bit	2	3-16 bit, 1-8 bit, 1-WDT	EUSART, MI ² C/SPI	40	8 MHz	PBOR/PLVD	3	1/1	✓	PSP
PIC18F4420	16384 EnhFI	256	768	36	40P, 44ML, 44PT	13x10-bit	2	3-16 bit, 1-8 bit, 1-WDT	EUSART, MI ² C/SPI	40	8 MHz	PBOR/PLVD	3	1/1	✓	PSP
PIC18F4431	16384 EnhFI	256	768	36	40P, 44ML, 44PT	9x10-bit 200 ksps	—	3-16 bit, 1-8 bit, 1-WDT	EUSART, I ² C/SPI	40	8 MHz	PBOR/PLVD	1	2/0	—	8 14-bit Motor Control PWMs, 2-ch Quadrature Encoder
PIC18F4439	12288 EnhFI	256	640	32	40P, 44ML, 44PT	8x10-bit	—	3-16 bit, 1-8 bit, 1-WDT	AUSART, MI ² C/SPI	40	—	PBOR/PLVD	1	—	—	Motor Control Kernel
PIC18F4455*	24576 EnhFI	256	2048	35	40P, 44ML, 44PT	13x10-bit	2	3-16 bit, 1-8 bit, 1-WDT	USB 2.0, MI ² C/SPI, EUSART	48	8 MHz	PBOR/PLVD	3	2/0	✓	Full Speed USB 2.0 Compliant, Streaming Port
PIC18F448	16384 EnhFI	256	768	34	40P, 44L, 44PT	8x10-bit	2	3-16 bit, 1-8 bit, 1-WDT	AUSART, MI ² C/SPI, CAN 2.0B	40	—	PBOR/PLVD	1	1/1	—	Full CAN 2.0B, 3 transmit buffers, 2 receive buffers, 6 acceptance filters, 2 filter masks, PSP
PIC18F4480*	16384 EnhFI	256	768	36	40P, 44ML, 44PT	11x10-bit	2	3-16 bit, 1-8 bit, 1-WDT	CAN 2.0B, MI ² C/SPI, EUSART	40	8 MHz	PBOR/PLVD	3	1/1	✓	ECAN
PIC18F4520	32768 EnhFI	256	1536	36	40P, 44ML, 44PT	13x10-bit	2	3-16 bit, 1-8 bit, 1-WDT	EUSART, MI ² C/SPI	40	8 MHz	PBOR/PLVD	3	1/1	✓	PSP

High Performance 8-Bit PICmicro® Microcontroller Family

Product	Program Memory (Bytes)	EEPROM Data Memory Bytes	RAM Bytes	I/O Pins	Packages	Analog		Digital		Max. Speed MHz	IntOSC	BOR/PBOR/PLVD	ICD # of Breakpoints	CCP/ECCP	nW	Other Features
						ADC Ch	Comp.	Timers/WDT	Serial I/O							
PIC18FXXX Flash MCUs (x16): Upwardly Compatible with PIC18CXXX/PIC17C7XX/PIC16CXX/PIC16C5X/PIC12CXXX, 77 Instructions, C Compiler Efficient Instruction Set, Software Stack Capability, Table Read/Write, 10 MIPS, 4x PLL, Switchable Oscillator Sources, 25 mA Source/Sink per I/O, ICSP™ (except ROM) (continued)																
PIC18F4510	32768 StdFI	—	1536	36	40P, 44ML, 44PT	13x10-bit	2	3-16 bit, 1-8 bit, 1-WDT	EUSART, Mi ² C/SPI	40	8 MHz	PBOR/PLVD	3	1/1	✓	PSP
PIC18F4515	49152 StdFI	—	3968	36	40P, 44ML, 44PT	13x10-bit	2	3-16 bit, 1-8 bit, 1-WDT	EUSART, Mi ² C/SPI	40	8 MHz	PBOR/PLVD	3	1/1	✓	PSP
PIC18F4525	49152 EnhFI	1024	3968	36	40P, 44ML, 44PT	13x10-bit	2	3-16 bit, 1-8 bit, 1-WDT	EUSART, Mi ² C/SPI	40	8 MHz	PBOR/PLVD	3	1/1	✓	PSP
PIC18F4539	24576 EnhFI	256	1408	32	40P, 44ML, 44PT	8x10-bit	—	3-16 bit, 1-8 bit, 1-WDT	AUSART, Mi ² C/SPI	40	—	PBOR/PLVD	1	—	—	Motor Control Kernel
PIC18F458	32768 EnhFI	256	1536	34	40P, 44L, 44PT	8x10-bit	2	3-16 bit, 1-8 bit, 1-WDT	AUSART, Mi ² C/SPI, CAN 2.0B	40	—	PBOR/PLVD	1	1/1	—	Full CAN 2.0B, 3 transmit buffers, 2 receive buffers, 6 acceptance filters, 2 filter masks, PSP
PIC18F4580*	32768 EnhFI	256	1536	36	40P, 44ML, 44PT	11x10-bit	2	3-16 bit, 1-8 bit, 1-WDT	CAN 2.0B, Mi ² C/SPI, EUSART	40	8 MHz	PBOR/PLVD	3	1/1	✓	ECAN
PIC18F4550*	32768 EnhFI	256	2048	35	40P, 44ML, 44PT	13x10-bit	2	3-16 bit, 1-8 bit, 1-WDT	USB 2.0, Mi ² C/SPI, EUSART	48	8 MHz	PBOR/PLVD	3	1/1	✓	Full Speed USB 2.0 Compliant, Streaming Port
PIC18F4585	49152 EnhFI	1024	3328	36	40P, 44ML, 44PT	11x10-bit	2	3-16 bit, 1-8 bit, 1-WDT	CAN 2.0B, Mi ² C/SPI, EUSART	40	8 MHz	PBOR/PLVD	3	1/1	—	ECAN
PIC18F4610	65536 StdFI	—	3968	36	40P, 44ML, 44PT	13x10-bit	2	3-16 bit, 1-8 bit, 1-WDT	EUSART, Mi ² C/SPI	40	8 MHz	PBOR/PLVD	3	1/1	✓	PSP
PIC18F4620	65536 EnhFI	1024	3968	36	40P, 44ML, 44PT	13x10-bit	2	3-16 bit, 1-8 bit, 1-WDT	EUSART, Mi ² C/SPI	40	8 MHz	PBOR/PLVD	3	1/1	✓	PSP
PIC18F4680	65536 EnhFI	1024	3328	36	40P, 44ML, 44PT	11x10-bit	2	3-16 bit, 1-8 bit, 1-WDT	CAN 2.0B, Mi ² C/SPI, EUSART	40	8 MHz	PBOR/PLVD	3	1/1	✓	ECAN
PIC18F6310	8192 StdFI	—	768	54	64PT	12x10-bit	2	3-16 bit, 1-8 bit, 1-WDT	Mi ² C/SPI, EUSART, AUSART	40	8 MHz	PBOR/PLVD	3	3/0	✓	EMA
PIC18F6410	16384 StdFI	—	768	54	64PT	12x10-bit	2	3-16 bit, 1-8 bit, 1-WDT	Mi ² C/SPI, EUSART, AUSART	40	8 MHz	PBOR/PLVD	3	3/0	✓	EMA
PIC18F6390	8192 StdFI	—	768	50	64PT	12x10-bit	2	3-16 bit, 1-8 bit, 1-WDT	Mi ² C/SPI, EUSART, AUSART	40	8 MHz	PBOR/PLVD	3	2/0	✓	LCD: up to 128 Segments
PIC18F6490	16384 StdFI	—	768	50	64PT	12x10-bit	2	3-16 bit, 1-8 bit, 1-WDT	Mi ² C/SPI, EUSART, AUSART	40	8 MHz	PBOR/PLVD	3	2/0	✓	LCD: up to 128 Segments
PIC18F6520	32768 EnhFI	1024	2048	52	64PT	12x10-bit	2	3-16 bit, 2-8 bit, 1-WDT	2x AUSART, Mi ² C/SPI	40	—	PBOR/PLVD	1	5/0	—	PSP
PIC18F6525	49152 EnhFI	1024	3840	53	64PT	12x10-bit	2	3-16 bit, 2-8 bit, 1-WDT	2x EUSART, Mi ² C/SPI	40	—	PBOR/PLVD	1	2/3	—	PSP

High Performance 8-Bit PICmicro® Microcontroller Family

Product	Program Memory (Bytes)	EEPROM Data Memory Bytes	RAM Bytes	I/O Pins	Packages	Analog		Digital		Max. Speed MHz	IntOSC	BOR/PBOR/PLVD	ICD # of Breakpoints	CCP/ECCP	nW	Other Features
						ADC Ch	Comp.	Timers/WDT	Serial I/O							
PIC18FXXX Flash MCUs (x16): Upwardly Compatible with PIC18CXXX/PIC17C7XX/PIC16CXX/PIC16C5X/PIC12CXXX, 77 Instructions, C Compiler Efficient Instruction Set, Software Stack Capability, Table Read/Write, 10 MIPS, 4x PLL, Switchable Oscillator Sources, 25 mA Source/Sink per I/O, ICSP™ (except ROM) (continued)																
PIC18F6585	49152 EnhFI	1024	3328	53	64PT, 68L	12x10-bit	2	3-16 bit, 1-8 bit, 1-WDT	EUSART, MI ² C/SPI, CAN 2.0B	40	—	PBOR/PLVD	1	1/1	—	ECAN
PIC18F6621	65536 EnhFI	1024	3840	53	64PT	12x10-bit	2	3-16 bit, 2-8 bit, 1-WDT	2x EUSART, MI ² C/SPI	40	—	PBOR/PLVD	1	2/3	—	PSP
PIC18F6627*	98304 EnhFI	1024	3936	54	64PT	12x10-bit	2	3-16 bit, 2-8 bit, 1-WDT	2x EUSART, 2x MI ² C/SPI	40	8 MHz	PBOR/PLVD	3	2/3	✓	PSP
PIC18F6680	65536 EnhFI	1024	3328	53	64PT, 68L	12x10-bit	2	3-16 bit, 1-8 bit, 1-WDT	EUSART, MI ² C/SPI, CAN 2.0B	40	—	PBOR/PLVD	1	1/1	—	ECAN
PIC18F6720	131072 EnhFI	1024	3840	52	64PT	12x10-bit	2	3-16 bit, 2-8 bit, 1-WDT	2x AUSART, MI ² C/SPI	25	—	PBOR/PLVD	1	5/0	—	PSP
PIC18F6722*	131072 EnhFI	1024	3936	54	64PT	12x10-bit	2	3-16 bit, 2-8 bit, 1-WDT	2x EUSART, 2x MI ² C/SPI	40	8 MHz	PBOR/PLVD	3	2/3	✓	PSP
PIC18F8310	8192 StdFI	—	768	70	80PT	12x10-bit	2	3-16 bit, 1-8 bit, 1-WDT	MI ² C/SPI, EUSART, AUSART	40	8 MHz	PBOR/PLVD	3	3/0	✓	EMA
PIC18F8410	16384 StdFI	—	768	70	80PT	12x10-bit	2	3-16 bit, 2-8 bit, 1-WDT	MI ² C/SPI, EUSART, AUSART	40	8 MHz	PBOR/PLVD	3	3/0	✓	EMA
PIC18F8390	8192 StdFI	—	768	66	80PT	12x10-bit	2	3-16 bit, 1-8 bit, 1-WDT	MI ² C/SPI, EUSART, AUSART	40	8 MHz	PBOR/PLVD	3	2/0	✓	LCD: up to 192 Segments
PIC18F8490	16384 StdFI	—	768	66	80PT	12x10-bit	2	3-16 bit, 2-8 bit, 1-WDT	MI ² C/SPI, EUSART, AUSART	40	8 MHz	PBOR/PLVD	3	2/0	✓	LCD: up to 192 Segments
PIC18F8520	32768 EnhFI	1024	2048	68	80PT	16x10-bit	2	2-8 bit, 3-16 bit, 1-WDT	2x AUSART, MI ² C/SPI	40	—	PBOR/PLVD	1	5/0	—	PSP, EMA
PIC18F8525	49152 EnhFI	1024	3840	69	80PT	16x10-bit	2	3-16 bit, 2-8 bit, 1-WDT	2x EUSART, MI ² C/SPI	40	—	PBOR/PLVD	1	2/3	—	PSP, EMA
PIC18F8585	49152 EnhFI	1024	3328	69	80PT	16x10-bit	2	3-16 bit, 1-8 bit, 1-WDT	EUSART, MI ² C/SPI, CAN2.0B	40	—	PBOR/PLVD	1	1/1	—	ECAN, EMA
PIC18F8621	65536 EnhFI	1024	3840	69	80PT	16x10-bit	2	3-16 bit, 2-8 bit, 1-WDT	2x EUSART, MI ² C/SPI	40	—	PBOR/PLVD	1	2/3	—	PSP, EMA
PIC18F8627*	98304 EnhFI	1024	3936	70	80PT	16x10-bit	2	3-16 bit, 2-8 bit, 1-WDT	2x EUSART, 2x MI ² C/SPI	40	8 MHz	PBOR/PLVD	3	2/3	✓	PSP, EMA
PIC18F8680	65536 EnhFI	1024	3328	69	80PT	16x10-bit	2	3-16 bit, 1-8 bit, 1-WDT	EUSART, MI ² C/SPI, CAN2.0B	40	—	PBOR/PLVD	1	1/1	—	ECAN, EMA
PIC18F8720	131072 EnhFI	1024	3840	68	80PT	16x10-bit	2	3-16 bit, 2-8 bit, 1-WDT	2x AUSART, MI ² C/SPI	25	—	PBOR/PLVD	1	5/0	—	PSP, EMA
PIC18F8722*	131072 EnhFI	1024	3936	70	80PT	16x10-bit	2	3-16 bit, 2-8 bit, 1-WDT	2x EUSART, 2x MI ² C/SPI	40	8 MHz	PBOR/PLVD	3	2/3	✓	PSP, EMA

*Contact Microchip Technology for availability date.

FOCUSED SOLUTIONS - PICmicro® MICROCONTROLLER FAMILY PRODUCTS

Product	Program Memory (Bytes)	EEPROM Data Memory Bytes	RAM Bytes	I/O Pins	Packages	Analog Peripherals	Digital Peripherals	Max. Speed MHz	ICD # of Breakpoints	Function-Specific Features					Development Boards
										ISO-16845 Tested	Transmit Buffers	Receive Buffers	Configurable RX/TX	Acceptance Filters/Mask	
Connectivity Solutions - CAN															
PIC18F248	16384 EnhFI	256	768	23	28SP, 28SO	ADC	AUSART, CCP	40	1	Yes	3	2	—	6/2	DM163011 PICDEM™ CAN-LIN 2
PIC18F2480*	16384 EnhFI	256	768	25	28SP, 28SO, 28ML	ADC	EUSART, CCP	40	3	Planned	3	2	6	16/2	DM163011 PICDEM™ CAN-LIN 2
PIC18F258	32768 EnhFI	256	1536	23	28SP, 28SO	ADC	AUSART, CCP	40	1	Yes	3	2	—	6/2	DM163011 PICDEM™ CAN-LIN 2
PIC18F2580*	32768 EnhFI	256	1536	25	28SP, 28SO, 28ML	ADC	EUSART, CCP	40	3	Planned	3	2	6	16/2	DM163011 PICDEM™ CAN-LIN 2
PIC18F2585	49152 EnhFI	1024	3328	25	28SP, 28SO	ADC	EUSART, CCP	40	3	Planned	3	2	6	16/2	DM163011 PICDEM™ CAN-LIN 2
PIC18F2680	65536 EnhFI	1024	3328	25	28SP, 28SO	ADC	EUSART, CCP	40	3	Planned	3	2	6	16/2	DM163011 PICDEM™ CAN-LIN 2
PIC18F448	16384 EnhFI	256	768	34	40P, 44PT, 44L	ADC/Comp	EUSART, CCP/ECCP	40	1	Yes	3	2	—	6/2	DM163011 PICDEM™ CAN-LIN 2
PIC18F4480*	16384 EnhFI	256	768	36	44PT, 44ML	ADC/Comp	EUSART, CCP/ECCP	40	3	Planned	3	2	6	16/2	DM163011 PICDEM™ CAN-LIN 2
PIC18F458	32768 EnhFI	256	1536	34	40P, 44PT, 44L	ADC/Comp	EUSART, CCP/ECCP	40	1	Yes	3	2	—	6/2	DM163011 PICDEM™ CAN-LIN 2
PIC18F4580*	32768 EnhFI	256	1536	36	44PT, 44ML	ADC/Comp	EUSART, CCP/ECCP	40	3	Planned	3	2	6	16/2	DM163011 PICDEM™ CAN-LIN 2
PIC18F4585	49152 EnhFI	1024	3328	36	40P, 44PT, 44ML	ADC/Comp	EUSART, CCP/ECCP	40	3	Planned	3	2	6	16/2	DM163011 PICDEM™ CAN-LIN 2
PIC18F4680	65536 EnhFI	1024	3328	36	40P, 44PT, 44ML	ADC/Comp	EUSART, CCP/ECCP	40	3	Planned	3	2	6	16/2	DM163011 PICDEM™ CAN-LIN 2
PIC18F6585	49152 EnhFI	1024	3328	53	64PT, 68L	ADC/Comp	EUSART, CCP/ECCP	40	1	Yes	3	2	6	16/2	DM163015 PICDEM™ CAN-LIN 3
PIC18F6680	65536 EnhFI	1024	3328	53	64PT, 68L	ADC/Comp	EUSART, CCP/ECCP	40	1	Yes	3	2	6	16/2	DM163015 PICDEM™ CAN-LIN 3
PIC18F8585	49152 EnhFI	1024	3328	69	80PT	ADC/Comp	EUSART, CCP/ECCP	40	1	Yes	3	2	6	16/2	DM163015 PICDEM™ CAN-LIN 3
PIC18F8680	65536 EnhFI	1024	3328	69	80PT	ADC/Comp	EUSART, CCP/ECCP	40	1	Yes	3	2	6	16/2	DM163015 PICDEM™ CAN-LIN 3

Refer to Design pages on www.microchip.com for further detail.

Product	MAC	PHY	TX/RX Dual Port RAM Buffer	Interrupts	LEDs	Operating Voltage (V)	Temp. Range (°C)	Max. Speed MHz	Serial	Features	Package	Development Boards
Ethernet												
MCP22S80*	Yes	Yes	8KB	2	2	3.3	-40 to +85	25	SPI	Loop back test modes, auto-polarity	28-Pin SO, 28-Pin SS, 28-Pin ML	

*Contact Microchip Technology Inc. for availability.

Product	Program Memory (Bytes)	EEPROM Data Memory Bytes	RAM Bytes	I/O Pins	Packages	Analog Peripherals	Digital Peripherals	Max. Speed MHz	ICD # of Breakpoints	Function-Specific Features					Development Boards
										Compliant	Speed	# of Endpoints	USB Buffer (bytes)	Streaming Port	
Connectivity Solutions - USB															
PIC16C745	14336 OTP	—	256	22	28SP, 28SO, 28JW	ADC	UART	24	—	USB 1.1	Low Speed (1.5Mbit/s)	16	64	—	DM163010, PICDEM™ USB
PIC16C765	14336 OTP	—	256	33	40P, 40JW, 44L, 44PT	ADC	UART	24	—	USB 1.1	Low Speed (1.5Mbit/s)	16	64	—	DM163010, PICDEM™ USB
PIC18F2455*	24576 EnhFI	256	2048	24	28SP, 28SO, 28ML	ADC/Comp	EUSART, MI ² C/SPI	48	3	USB 2.0	Full Speed (12Mbit/s)	16	1024	—	
PIC18F2550*	32768 EnhFI	256	2048	24	28SP, 28SO, 28ML	ADC/Comp	EUSART, MI ² C/SPI	48	3	USB 2.0	Full Speed (12Mbit/s)	16	1024	—	
PIC18F4455*	24576 EnhFI	256	2048	36	40P, 44PT, 44ML	ADC/Comp	EUSART, MI ² C/SPI	48	3	USB 2.0	Full Speed (12Mbit/s)	16	1024	Yes	
PIC18F4550*	32768 EnhFI	256	2048	36	40P, 44PT, 44ML	ADC/Comp	EUSART, MI ² C/SPI	48	3	USB 2.0	Full Speed (12Mbit/s)	16	1024	Yes	

*Contact Microchip Technology Inc. for availability.
Refer to Design pages on www.microchip.com for further details.

Connectivity Solutions - ACTIVE RF															
rfPIC® Microcontrollers with UHF RF Transmitter, ICSP™															
Product	Program Memory (Bytes)	EEPROM Data Memory Bytes	RAM Bytes	I/O Pins	Packages	Analog Peripherals	Digital Peripherals	Max. Speed (MHz)	Function-Specific Specifications					Development Boards	
									Modulation	Data Rate (kbps)	Output Power (dBm)	Operating Voltage (V)	Frequency Range (MHz)		
rfPIC12C509AF	1536 OTP	—	41	6	20JW, 20SS	—	1-8 bit Timer, WDT	4	FSK, ASK	40	2	2.5-5.5	310-440		
rfPIC12C509AG	1536 OTP	—	41	6	18JW, 18SO	—	1-8 bit Timer, WDT	4	ASK	40	2	2.5-5.5	310-440		
rfPIC12F675F	1792 StdFI	128	64	6	20SS	4x10-bit A/D, Comp	1-8 bit, 1-16 bit Timer, WDT	20	FSK, ASK	40	10	2.0-5.5	380-450	DV164102, rfPIC® Development Kit	
rfPIC12F675H	1792 StdFI	128	64	6	20SS	4x10-bit A/D, Comp	1-8 bit, 1-16 bit Timer, WDT	20	FSK, ASK	40	10	2.0-5.5	850-930	DV164102, rfPIC® Development Kit	
rfPIC12F675K	1792 StdFI	128	64	6	20SS	4x10-bit A/D, Comp	1-8 bit, 1-16 bit Timer, WDT	20	FSK, ASK	40	10	2.0-5.5	290-350	DV164102, rfPIC® Development Kit	
rfHCS KEELoq® Encoders with UHF RF Transmitter															
Product	Transmission Code Length Bits	Code Hopping Bits	Programmable Encryption Key Bits	Packages	Protocols	Function Codes	Tunable OSC	CRC	Function-Specific Specifications				Development Boards		
									Modulation	Output Power (dBm)	Operating Voltage (V)	Frequency Range (MHz)			
rfHCS362F	69	32	2 x 64	20SS	PWM, Manchester	4 x 15	✓	✓	FSK, ASK	2	2.2-5.5	310-440	DM303006, KEELoq® Evaluation Kit II		
rfHCS362G	69	32	2 x 64	18SO	PWM, Manchester	4 x 15	✓	✓	ASK	2	2.2-5.5	310-440	DM303006, KEELoq® Evaluation Kit II		
UHF RF Receiver															
Product	Modulation	Data Rate (kbps)	Frequency Range (MHz)	Sensitivity dBm (FSK)	IF Frequency Range (MHz)	Operating Voltage (V)	Package	Development Boards							
rfRXD0420	ASK, FSK, FM	80	300-450	-111	0.455-21.4	2.5-5.5	32LQ	DV164102, rfPIC® Development Kit							
rfRXD0920	ASK, FSK, FM	80	800-930	-109	0.455-21.4	2.5-5.5	32LQ	DV164102, rfPIC® Development Kit							

Refer to Design pages on www.microchip.com for further details.

Focused Solutions
PICmicro® MCU Products

Product	Program Memory Bytes	EEPROM Data Memory Bytes	RAM Bytes	I/O Pins	Packages	Analog Peripherals	Digital Peripherals	Max. Speed MHz	ICD # of Breakpoints	LCD Function-Specific Features					Development Boards
										COMxSegment = # Segments	Drive in Sleep	Software Configurable Driver Pins	Direct Drive	Intl. Charge Pump	
LCD Solutions															
PIC16C925	7168 OTP	—	176	52	64PT, 68CL, 68L	ADC	I ² C/SPI	20	—	4x29 (116)	Yes	No	Yes	Yes	DM163003, PICDEM™ 3 LCD
PIC16C926	14336 OTP	—	336	52	64PT, 68CL, 68L	ADC	I ² C/SPI	20	—	4x29 (116)	Yes	No	Yes	Yes	DM163003, PICDEM™ 3 LCD
PIC16F913*	7168 EnhFI	256	256	25	28P, 28SO, 28SS, 28QFN	ADC/Comp	AUSART, I ² C/SPI	20	1	4x15 (60)	Yes	Yes	Yes	No	
PIC16F914*	7168 EnhFI	256	256	36	40P, 44TQFP, 44QFN	ADC/Comp	AUSART, I ² C/SPI	20	1	4x24 (96)	Yes	Yes	Yes	No	
PIC16F916*	14336 EnhFI	256	352	25	28P, 28SO, 28SS, 28QFN	ADC/Comp	AUSART, I ² C/SPI	20	1	4x15 (60)	Yes	Yes	Yes	No	
PIC16F917*	14336 EnhFI	256	352	36	40P, 44TQFP, 44QFN	ADC/Comp	AUSART, I ² C/SPI	20	1	4x24 (96)	Yes	Yes	Yes	No	
PIC18F6390	8192 StdFI	—	768	50	64PT	ADC/Comp	EUSART, AUSART, MI ² C/SPI	40	3	4x32 (128)	Yes	Yes	Yes	No	DM163028, PICDEM™ LCD Demo Board
PIC18F6490	16384 StdFI	—	768	50	64PT	ADC/Comp	EUSART, AUSART, MI ² C/SPI	40	3	4x32 (128)	Yes	Yes	Yes	No	DM163028, PICDEM™ LCD Demo Board
PIC18F8390	8192 StdFI	—	768	66	80PT	ADC/Comp	EUSART, AUSART, MI ² C/SPI	40	3	4x48 (192)	Yes	Yes	Yes	No	DM163028, PICDEM™ LCD Demo Board
PIC18F8490	16384 StdFI	—	768	66	80PT	ADC/Comp	EUSART, AUSART, MI ² C/SPI	40	3	4x48 (192)	Yes	Yes	Yes	No	DM163028, PICDEM™ LCD Demo Board

*Contact Microchip Technology Inc. for availability.
Refer to Design pages on www.microchip.com for further details.

Product	Program Memory Bytes	EEPROM Data Memory Bytes	RAM Bytes	I/O Pins	Packages	Analog Peripherals	Digital Peripherals	Max. Speed MHz	ICD # of Breakpoints	Function-Specific Features					Other Features
										Timers	Input Capture	Output Comp/Std PWM	Motor Control PWM	Quadrature Encoder	
Motor Control Solutions															
PIC12F683	3584 StdFI	256	128	6	8P, 8SN, 8MF	ADC/Comp	—	20	1	1-16 bit, 2-8 bit, WDT	1	1x10 bit	—	—	PICkit™ 1
PIC16F684	3584 EnhFI	256	128	12	14P, 14SL, 14ST	ADC/Comp	—	20	1	1-16 bit, 2-8 bit, WDT	1	4x10 bit	—	—	PICkit™ 1
PIC16F716	3584 StdFI	—	128	13	18P, 18SO, 20SS	ADC	—	20	1	1-16 bit, 2-8 bit, WDT	1	4x10 bit	—	—	DM163022, PICDEM™ 2 Plus
PIC16F737	7168 StdFI	—	368	25	28SP, 28SO, 28SS, 28ML	ADC/Comp	USART, MI ² C/SPI	20	1	1-16 bit, 2-8 bit, WDT	3	3x10 bit	—	—	DM163022, PICDEM™ 2 Plus
PIC16F747	7168 StdFI	—	368	36	40P, 44PT, 44ML	ADC/Comp	USART, MI ² C/SPI	20	1	1-16 bit, 2-8 bit, WDT	3	3x10 bit	—	—	DM163022, PICDEM™ 2 Plus
PIC16F767	14336 StdFI	—	368	25	28SP, 28SO, 28SS, 28ML	ADC/Comp	USART, MI ² C/SPI	20	1	1-16 bit, 2-8 bit, WDT	3	3x10 bit	—	—	DM163022, PICDEM™ 2 Plus
PIC16F777	14336 StdFI	—	368	36	40P, 44PT, 44ML	ADC/Comp	USART, MI ² C/SPI	20	1	1-16 bit, 2-8 bit, WDT	3	3x10 bit	—	—	DM163022, PICDEM™ 2 Plus
PIC18F1230*	4096 EnhFI	128	256	16	18P, 18SO, 20SS, 28ML	ADC/Comp	EUSART	40	3	2-16 bit, WDT	—	—	6	—	DM183011 PICDEM™ MC
PIC18F1330*	8192 EnhFI	128	256	16	18P, 18SO, 20SS, 28ML	ADC/Comp	EUSART	40	3	2-16 bit, WDT	—	—	6	—	DM183011 PICDEM™ MC
PIC18F2331	8192 EnhFI	256	768	22	28SP, 28SO	200 ksps ADC	EUSART, I ² C/SPI	40	1	3-16 bit, 1-8 bit, WDT	3	2x10 bit	6	Yes	DM183011, PICDEM™ MC
PIC18F2431	16384 EnhFI	256	768	22	28SP, 28SO	200 ksps ADC	EUSART, I ² C/SPI	40	1	3-16 bit, 1-8 bit, WDT	3	2x10 bit	6	Yes	DM183011, PICDEM™ MC
PIC18F2439	12288 EnhFI	256	640	21	28SP, 28SO	ADC	AUSART, MI ² C/SPI	40	1	3-16 bit, WDT	—	2x10 bit	—	—	DM183010, Motor Control Kit
PIC18F2539	24576 EnhFI	256	1408	21	28SP, 28SO	ADC	AUSART, MI ² C/SPI	40	1	3-16 bit, WDT	—	2x10 bit	—	—	DM183010, Motor Control Kit
PIC18F4331	8192 EnhFI	256	768	34	40P, 44PT, 44ML	200 ksps ADC	EUSART, I ² C/SPI	40	1	3-16 bit, 1-8 bit, WDT	3	2x10 bit	8	Yes	DM183011, PICDEM™ MC
PIC18F4431	16384 EnhFI	256	768	34	40P, 44PT, 44ML	200 ksps ADC	EUSART, I ² C/SPI	40	1	3-16 bit, 1-8 bit, WDT	3	2x10 bit	8	Yes	DM183011, PICDEM™ MC
PIC18F4439	12228 EnhFI	256	640	32	40P, 44PT, 44ML	ADC	AUSART, MI ² C/SPI	40	1	3-16 bit, WDT	—	2x10 bit	—	—	DM183010, Motor Control Kit
PIC18F4539	24576 EnhFI	256	1408	32	40P, 44PT, 44ML	ADC	AUSART, MI ² C/SPI	40	1	3-16 bit, WDT	—	2x10 bit	—	—	DM183010, Motor Control Kit

*Contact Microchip Technology Inc. for availability.
Refer to Design pages on www.microchip.com for further details.

Power Managed Solutions Featuring <i>nanoWatt</i> Technology			
Minimum nanoWatt Feature Set	6-20 Pin	28-40 Pin	60-80 Pin
Internal Oscillator	PIC16F627A, PIC16F628A, PIC16F648A		
Quick Start-up (4 MHz)			
Power Managed Modes			
Sleep			
Low Power Timer1			
Low Power Watchdog			
Additional Features to Minimum			
IntOSC: Quick Start-up (Two-speed) and Clock Divide (8 MHz) BOR	PIC16F818, PIC16F819		
IntOSC: Quick Start-up (Two-speed), Fail-safe Clock Monitor and Clock Divide (8 MHz) Ultra Low Power Wake-up	PIC12F683 PIC16F684, PIC16F688		
IntOSC: Quick Start-up (Two-speed), Fail-safe Clock Monitor and Clock Divide (8 MHz) Ultra Low Power Wake-up Low Power Watchdog – Enhanced Software Controlled BOR	PIC16F631, PIC16F677, PIC16F685, PIC16F687, PIC16F689, PIC16F785		
IntOSC: Quick Start-up (Two-speed), Fail-safe Clock Monitor and Clock Divide (8 MHz) Ultra Low Power Wake-up Wake-up Reset Low Power Watchdog – Enhanced PLVD Software Controlled BOR	PIC12F635 PIC16F636, PIC16F639		
IntOSC: Quick Start-up (Two-speed), Fail-safe Clock Monitor and Selectable Clock (31 kHz-8 MHz) Power Managed Modes: RC Run Modes PLVD PBOR	PIC16F88, PIC16F87	PIC16F777, PIC16F767, PIC16F747, PIC16F737, PIC16F917, PIC16F916, PIC16F914, PIC16F913	
IntOSC: Quick Start-up (Two-speed), Fail-safe clock monitor and Selectable Clock (31 kHz-8 MHz) Power Managed Modes: Multiple Idle Modes and RC Run Modes PLVD PBOR	PIC18F1320, PIC18F1220	PIC18F4220, PIC18F4320, PIC18F2220, PIC18F2320, PIC18F4620, PIC18F4610, PIC18F4525, PIC18F4515, PIC18F2620, PIC18F2610, PIC18F2525, PIC18F2515, PIC18F4520, PIC18F4510, PIC18F2520, PIC18F2510, PIC18F4420, PIC18F4410, PIC18F2420, PIC18F2410, PIC18F2331, PIC18F2431, PIC18F4431, PIC18F4331, PIC18F2550, PIC18F2585, PIC18F2680, PIC18F4455, PIC18F4550, PIC18F4585, PIC18F4680, PIC18F4580, PIC18F2680, PIC18F2580	PIC18F8490, PIC18F8410, PIC18F8390, PIC18F8310, PIC18F6490, PIC18F6410, PIC18F6390, PIC18F6310, PIC18F8722, PIC18F8627, PIC18F8622, PIC18F8527, PIC18F8522, PIC18F8410, PIC18F8310, PIC18F6722, PIC18F6622, PIC18F6527, PIC18F6522

For additional details, please refer to device data sheets and design pages on www.microchip.com.

MATURE – PICmicro[®] MICROCONTROLLER FAMILY PRODUCTS

Not recommended for new designs.

Please use a device from the recommended column for new designs.

Product	Program Memory (Bytes)	Package Size	Recommended Design-In Device
PIC12C508	768	8	PIC12F508
PIC12C509	1536	8	PIC12F509
PIC12C671	1536	8	PIC12F675
PIC12C672	3584	8	PIC12F683
PIC12CE673	1792	8	PIC12F675
PIC12CE674	3584	8	PIC12F683
PIC12CE518	768	8	PIC12F629
PIC12CE519	1536	8	PIC12F629
PIC12CR509A	1536	8	PIC12F509
PIC16C54	768	18	PIC16F54
PIC16C54A	768	18	PIC16F54
PIC16C55	768	28	PIC16C55A
PIC16C56	1536	18	PIC16C56A
PIC16C57	3072	28	PIC16F57
PIC16C62A	3584	28	PIC16C62B or PIC16F72
PIC16C620	896	18	PIC16C620A
PIC16C621	1792	18	PIC16C621A
PIC16C622	3584	18	PIC16C622A
PIC16C63	7168	28	PIC16C63B or PIC16F73
PIC16C64A	3584	40	PIC16F74
PIC16C642	7168	28	PIC16F72
PIC16C65A	7168	40	PIC16C65B or PIC16F74
PIC16C66	14336	28	PIC16F76
PIC16C662	7168	40	PIC16F74
PIC16C67	14336	40	PIC16F77
PIC16C71	1792	18	PIC16F716
PIC16C72	3584	28	PIC16C72A or PIC16F72
PIC16C710	896	18	PIC16F716
PIC16C711	1792	18	PIC16F716
PIC16C712	1792	18	PIC16F716
PIC16C715	3584	18	PIC16F716
PIC16C716	3584	18	PIC16F716
PIC16C73A	7168	28	PIC16C73B or PIC16F73
PIC16C74A	7168	40	PIC16C74B or PIC16F74
PIC16C76	14336	28	PIC16F76
PIC16C505	1536	14	PIC16F505
PIC16C54C	768	18	PIC16F54
PIC16C57C	3072	28	PIC16F57

Product	Program Memory (Bytes)	Package Size	Recommended Design-In Device
PIC16C77	14336	40	PIC16F77
PIC16C923	7168	68	PIC16C925
PIC16C924	7168	68	PIC16C925
PIC16CE623	896	18	PIC16F627A
PIC16CE624	1792	18	PIC16F627A
PIC16CE625	3584	18	PIC16F628A
PIC16CR54A	768	18	PIC16CR54C
PIC16CR54C	768	18	PIC16F54
PIC16CR57C	3072	28	PIC16F57
PIC16CR83	896	18	PIC16F84A
PIC16CR84	1792	18	PIC16F84A
PIC16F627	1792	18	PIC16F627A
PIC16F628	3584	18	PIC16F628A
PIC16F83	896	18	PIC16F84A
PIC16F84	1792	18	PIC16F84A
PIC16F873	7168	28	PIC16F873A
PIC16F874	7168	28	PIC16F874A
PIC16F876	14336	40	PIC16F876A
PIC16F877	14336	40	PIC16F877A
PIC17C42A	4096	40	PIC18F4220
PIC17C43	8192	40	PIC18F4320
PIC17C44	16384	40	PIC18F442
PIC17C752	16384	68	PIC18F6520
PIC17C756A	32768	68	PIC18F6520
PIC17C762	16384	84	PIC18F8520
PIC17C766	32768	84	PIC18F8520
PIC18C242	16384	28	PIC18F2420
PIC18C252	32768	28	PIC18F2520
PIC18C442	16384	40	PIC18F4420
PIC18C452	32768	40	PIC18F4520
PIC18C658	32768	68	PIC18F6585
PIC18C858	32768	84	PIC18F8585
PIC18F6620	65536	64	PIC18F6621
PIC18F8620	65536	80	PIC18F8621
PIC18F242	16384	28	PIC18F2420
PIC18F252	32768	28	PIC18F2520
PIC18F442	16384	40	PIC18F4420
PIC18F452	32768	40	PIC18F4520

BATTERY MANAGEMENT FAMILY PRODUCTS

Battery Fuel Gauge ICs												
Product	Battery Chemistry	# of Cells	Interface	Data Set	A/D Converter	Programmable Memory	Programmable I/O Functions	Accuracy	Time Base	Temp. Sensor	Packaging	Description
PS501	Li-Ion NimH	2-4 6-12	SMBus	> 1%	16-bit Sigma-Delta	16-Kbytes Flash, 256 bytes EEPROM	12 GPIO	N/A	On-chip	On-chip external	28-pin SSOP	Single chip reprogrammable battery manager IC reports capacity, current, temperature, voltage and other status for Li-Ion or Nickel batteries.
PS700	Li-Ion	1 - 2	SMBus v1.1	> 1%	16-bit Sigma-Delta	512 bytes EEPROM	1 A/D input, 2 inputs configurable as GPIO or A/D inputs	N/A	On-chip	On-chip and external	8-pin TSOP	Highly accurate analog front end that measures, stores and reports all of the critical parameters required for rechargeable battery monitoring with a minimum of external components.

Supporting Development Tools are listed in the Development Systems Products Section.

dsPIC® DIGITAL SIGNAL CONTROLLER (DSC) PRODUCTS

Product	Program (FLASH) KBytes	Memory (FLASH) KWords	EE Bytes	SRAM Bytes	Packages	A/D 12-bit 100 KSPS	A/D 10-bit 500 KSPS	Timer 16-bit	Input Cap	Output Comp/Std PWM	Motor Control PWM	Quad Enc.	UART	SPI™	I ² C™	CAN	Codec Interface
dsPIC30F Motor Control and Power Conversion Family																	
dsPIC30F2010	12	4	1024	512	28SOG, 28SPG, 28MMG	—	6 ch	3	4	2	6	✓	1	1	1	—	
dsPIC30F4011	48	16	1024	2048	40PG, 44PTG, 44MMG	—	6 ch	5	4	4	6	✓	2	1	1	1	
dsPIC30F4012	48	16	1024	2048	28SOG, 28SPG	—	6 ch	5	4	2	6	✓	1	1	1	1	
dsPIC30F6010	144	48	4096	8192	80PF	—	16 ch	5	8	8	8	✓	2	2	1	2	
dsPIC30F General Purpose Family																	
dsPIC30F3014	24	8	1024	2048	40PG, 44PTG	13 ch	—	3	2	2	No	No	2	1	1	—	
dsPIC30F4013	48	16	1024	2048	40PG, 44PTG	13 ch	—	5	4	4	No	No	2	1	1	1	AC97, I ² S
dsPIC30F5011	66	22	1024	4096	64PTG	16 ch	—	5	8	8	No	No	2	2	1	2	AC97, I ² S
dsPIC30F5013	66	22	1024	4096	80PTG	16 ch	—	5	8	8	No	No	2	2	1	2	AC97, I ² S
dsPIC30F6011	132	44	2048	6144	64PF	16 ch	—	5	8	8	No	No	2	2	1	2	
dsPIC30F6012	144	48	4096	8192	64PF	16 ch	—	5	8	8	No	No	2	2	1	2	AC97, I ² S
dsPIC30F6013	132	44	2048	6144	80PF	16 ch	—	5	8	8	No	No	2	2	1	2	
dsPIC30F6014	144	48	4096	8192	80PF	16 ch	—	5	8	8	No	No	2	2	1	2	AC97, I ² S
dsPIC30F Sensor Family																	
dsPIC30F2011	12	4	0	1024	18SOG, 18PG	8 ch	—	3	2	2	No	No	1	1	1	—	
dsPIC30F2012	12	4	0	1024	28SOG, 28SPG	10 ch	—	3	2	2	No	No	1	1	1	—	
dsPIC30F3012	24	8	1024	2048	18SOG, 18PG	8 ch	—	3	2	2	No	No	1	1	1	—	
dsPIC30F3013	24	8	1024	2048	28SOG, 28SPG	10 ch	—	3	2	2	No	No	2	1	1	—	

RADIO FREQUENCY PRODUCTS

PASSIVE								
microID® RFID Tagging Devices								
Product	Carrier Frequency	Programming	Anticollision	Memory Type	Memory Size	Protocols	Packages	Other
MCRF200	100-150 kHz	Factory	No	OTP	96/128 bits	PSK, FSK, ASK, bi-phase, Manchester, NRZ	W, WF, S, WB, WFB, SB, 1M, 3M, P, SN	–
MCRF202	100-150 kHz	Factory	Yes	OTP	96/128 bits	FSK, ASK, bi-phase, Manchester, NRZ	W, WF, S, WB, WFB, SB, P, SN	Sensor input
MCRF250	100-150 kHz	Factory	Yes	OTP	96/128 bits	PSK, FSK, ASK, bi-phase, Manchester, NRZ	W, WF, S, WB, WFB, SB, 1M, 3M, P, SN	–
MCRF355	13.56 MHz	Contact/Factory	Yes	R/W	154 bits	ASK Manchester	W, WF, S, WB, WFB, SB, P, SN, 7M	–
MCRF360	13.56 MHz	Contact/Factory	Yes	R/W	154 bits	ASK Manchester	W, WF, S, WB, WFB, SB, P, SN	100 pF res cap
MCRF450	13.56 MHz	Contactless	Yes	R/W	1 Kbit	PPM, ASK Manchester	W, WF, S, WB, WFB, SB, P, SN, 7M	32-bit unique ID user lock control by block
MCRF451	13.56 MHz	Contactless	Yes	R/W	1 Kbit	PPM, ASK Manchester	W, WF, S, WB, WFB, SB, P, SN, 7M	100 pF res cap
MCRF452	13.56 MHz	Contactless	Yes	R/W	1 Kbit	PPM, ASK Manchester	W, WF, S, WB, WFB, SB, P, SN, 7M	Dual 50 pF res cap
MCRF455	13.56 MHz	Contactless	Yes	R/W	1 Kbit	PPM, ASK Manchester	W, WF, S, WB, WFB, SB, P, SN, 7M	50 pF res cap

SECURE DATA PRODUCTS

KEELOQ® Encoder Devices											
Product	Transmission Code Length Bits	Code Hopping Bits	Programmable Encryption Key Bits	Seed Length	Operating Voltage (V)	Turnable OSC	Function Codes	CRC	Protocols	Other Features	Packages
HCS101	66	—	—	—	3.5 to 13.0	✓	7	No	PWM	Fixed code support for non-secure applications, up to 28-bit serial numbers	8P, 8SN
HCS200	66	32	64	32	3.5 to 13.0	No	7	No	PWM	Entry level, Fixed code support, Battery low indicator	8P, 8SN
HCS201	66	32	64	32	3.5 to 13.0	✓	7	No	PWM	Entry level, Fixed code support, Battery low indicator, Step-up voltage operation	8P, 8SN
HCS300	66	32	64	32	2.0 to 6.3	No	15	No	PWM	LED Drive, Overflow bits, Time-out, Battery low indicator	8P, 8SN
HCS301	66	32	64	32	3.5 to 13.0	No	15	No	PWM	LED Drive, Overflow bits, Time-out, Battery low indicator	8P, 8SN
HCS320	66	32	64	32	3.5 to 13.0	No	16	No	PWM	Shift Operation, LED Drive, Overflow bits, Time-out, Battery low indicator	8P, 8SN
HCS360	67	32	64	48	2.0 to 6.3	No	15	✓	IR Mode, PWM and Manchester	2 independent counters	8P, 8SN
HCS361	67	32	64	48	2.0 to 6.3	No	15	✓	IR Mode, PWM and VPWM	2 independent counters	8P, 8SN
HCS362	69	32	2 x 64	60	2.0 to 6.3	✓	15	✓	PWM and Manchester	Queue counter, PLL interface, Timer bits, Programmable time-out	8P, 8SN, 8ST
HCS365	69	32	2 x 64	2 x 60	2.05 to 5.5	Factory	15	✓	PWM, VPWM PPM and Manchester	Dual Encoder Operation, 4 inputs, Queue counter	8P, 8SM
HCS370	69	32	2 x 64	2 x 60	2.05 to 5.5	Factory	15	✓	PWM, VPWM PPM and Manchester	Step-up voltage regulation, Dual Encoder Operation, 6 inputs, Queue counter	14P, 14SL
HCS410	69	32	2 x 64	60	2.0 to 6.6	✓	7	✓	PWM and Manchester	Self-powered transponder and encoder, Bidirectional authentication, User EEPROM, Queue counter	8P, 8SN, 8ST
KEELOQ® Decoder Devices											
Product	Reception Length Bits	Encoders Supported**		Transmitters Supported	Operating Voltage (V)	Functions		Other Features		Packages	
HCS500	66	HCS200, HCS201, HCS300, HCS301, HCS320, HCS360, HCS361, HCS362, HCS365, HCS370, HCS410, HCS412, HCS473		Up to 7	3.0 to 5.5	S0, 15 Serial Functions		Full-featured decoder with serial interface to microcontrollers		8P, 8SM	
HCS512	66	HCS200, HCS201, HCS300, HCS301, HCS320, HCS360, HCS361, HCS362, HCS365, HCS370, HCS410, HCS412, HCS473		Up to 4	4.0 to 6.0	S0, S1, S2, S3; VLow, 15 Serial Functions		Single-chip decoder with secure learning		18P, 18SO	
HCS515	66	HCS200, HCS201, HCS300, HCS301, HCS320, HCS360, HCS361, HCS362, HCS365, HCS370, HCS410, HCS412, HCS473		Up to 7	4.5 to 5.5	S0, S1, 15 Serial Functions		Full-featured decoder with serial and parallel interface. On-chip 1K transmitter and 1K user EEPROM.		14P, 14SL	

* Contact Microchip Technology for availability date.

** Requires ICD specific device with header module – refer to Development Tools.

KEELOQ® Secure Data Products

KEELOQ® Programmable Encoder/Decoder Flash Devices (x14), ICSP™															
Product	Program Memory (Bytes)	EEPROM Data Memory (Bytes)	RAM Bytes	I/O Pins	Analog		Digital		Max. Speed MHz	IntOSC	BOR/PBOR/PLVD	ICD # of Breakpoints	nW	Other Features	Packages
					ADC Channels	Comparators	Timers/WDT	Serial I/O							
PIC12F635	1792 EnhFI	128	64	6	—	1	1-16 bit, 1-8 bit, 1-WDT	—	20	8 MHz	BOR/PLVD	1**	✓		8P, 8SN, 8MF
PIC16F636	3584 EnhFI	256	128	12	—	2	1-16 bit, 1-8 bit, 1-WDT	—	20	8 MHz	BOR/PLVD	1**	✓		14P, 14SL, 14ST
PIC16F639*	3584 EnhFI	256	128	12	—	2	1-16 bit, 1-8 bit, 1-WDT	—	20	8 MHz	BOR/PLVD	1**	✓	Transponder Analog Front End	20P, 20SO, 20SS

* Contact Microchip Technology for availability date.

** Requires ICD specific device with header module – refer to Development Tools.

ANALOG/INTERFACE PRODUCTS

Lead-free versions of many devices are currently offered. Check Microchip's website for availability.

THERMAL MANAGEMENT PRODUCTS – Temperature Sensors							
Part #	Typical Accuracy (°C)	Maximum Accuracy @ 25°C (°C)	Maximum Temperature Range (°C)	Vcc Range (V)	Maximum Supply Current (μA)	Features	Packages
Logic Output Temperature Sensors							
TC6501	±0.5	±3	-55 to +125	+2.7 to +5.5	40	Cross to MAX6501, Open-drain	5-Pin SOT-23A
TC6502	±0.5	±3	-55 to +125	+2.7 to +5.5	40	Cross to MAX6502, Push-pull	5-Pin SOT-23A
TC6503	±0.5	±3	-55 to +125	+2.7 to +5.5	40	Cross to MAX6503, Open-drain	5-Pin SOT-23A
TC6504	±0.5	±3	-55 to +125	+2.7 to +5.5	40	Cross to MAX6504, Push-pull	5-Pin SOT-23A
TC620	±1	±3	-40 to +125	+4.5 to +18	400	Two resistor-programmable trip points	8-Pin PDIP, 8-Pin SOIC
TC621	Note 1	Note 1	-40 to +85	+4.5 to +18	400	Uses external temperature sensor, resistor-programmable trip points	8-Pin PDIP, 8-Pin SOIC
TC622	±1	±5	-40 to +125	+4.5 to +18	600	Dual output, TO-220 for heat sink mounting, resistor-programmable trip points	8-Pin PDIP, 8-Pin SOIC, 5-Pin TO-220
TC623	±1	±3	-40 to +125	+2.7 to +4.5	250	Two resistor-programmable trip points	8-Pin PDIP, 8-Pin SOIC
TC624	±1	±5	-40 to +125	+2.7 to +4.5	300	Dual output, resistor-programmable trip points	8-Pin PDIP, 8-Pin SOIC
Voltage Output Temperature Sensors							
TC1046	±0.5	±2	-40 to +125	+2.7 to +4.4	60	High precision temperature-to-voltage converter, 6.25 mV/°C	3-Pin SOT-23B
TC1047	±0.5	±2	-40 to +125	+2.7 to +4.4	60	High precision temperature-to-voltage converter, 10 mV/°C	3-Pin SOT-23B
TC1047A	±0.5	±2	-40 to +125	+2.5 to +5.5	60	High precision temperature-to-voltage converter, 10 mV/°C	3-Pin SOT-23B
Serial Output Temperature Sensors							
MCP9800	±0.5	±1	-55 to +125	+2.7 to +5.5	400	SMBus/I ² C™ compatible interface, 0.0625°C to 0.5°C adj. resolution, power-saving one-shot temperature measurement	5-Pin SOT-23
MCP9801	±0.5	±1	-55 to +125	+2.7 to +5.5	400	SMBus/I ² C™ compatible interface, 0.0625°C to 0.5°C adj. resolution, power-saving one-shot temperature measurement, multi-drop capability	8-Pin MSOP, 8-pin SOIC
MCP9802	±0.5	±1	-55 to +125	+2.7 to +5.5	400	SMBus/I ² C™ compatible interface with time out, 0.0625°C to 0.5°C adj. resolution, power-saving one-shot temperature measurement	5-Pin SOT-23

NOTE 1: These devices use an external temperature sensor. Accuracy of the total solution is a function of the accuracy of the external sensor.
NOTE 2: TCN75 idle current is 250 μA. This device also has a Software Shutdown mode that reduces supply current to <1 μA.

Analog/Interface Family Products

THERMAL MANAGEMENT PRODUCTS – Temperature Sensors

Part #	Typical Accuracy (°C)	Maximum Accuracy @ 25°C (°C)	Maximum Temperature Range (°C)	Vcc Range (V)	Maximum Supply Current (µA)	Features	Packages
Serial Output Temperature Sensors (continued)							
MCP9803	±0.5	±1	-55 to +125	+2.7 to +5.5	400	SMBus/I ² C™ compatible interface with time out, 0.0625°C to 0.5°C adj. resolution, power-saving one-shot temperature measurement, multi-drop capability	8-Pin MSOP, 8-Pin SOIC
TC77	±0.5	±1	-55 to +125	+2.7 to +5.5	400	SPI™ compatible interface, 0.0625°C temperature resolution	5-Pin SOT-23A, 8-Pin SOIC
TC72	±0.5	±1	-55 to +125	+2.65 to +5.5	400	SPI™ compatible interface, power saving one-shot temperature measurement, 0.25°C temperature resolution	8-Pin MSOP, 8-Pin 3x3 DFN
TC74	±0.5	±2	-40 to +125	+2.7 to +5.5	350	SMBus/I ² C™ compatible interface, 1°C temperature resolution	5-Pin SOT-23A, 5-Pin TO-220
TCN75	±0.5	±2	-55 to +125	+2.7 to +5.5	1,000 ⁽²⁾	SMBus/I ² C™ compatible interface, multi-drop capability, interrupt output, 0.5°C temperature resolution	8-Pin MSOP, 8-Pin SOIC

NOTE 1: These devices use an external temperature sensor. Accuracy of the total solution is a function of the accuracy of the external sensor.
NOTE 2: TCN75 idle current is 250 µA. This device also has a Software Shutdown mode that reduces supply current to <1 µA.

THERMAL MANAGEMENT PRODUCTS – Brushless DC Fan Controllers and Fan Fault Detectors

Part #	Description	Typical Accuracy (°C)	Maximum Accuracy @ 25°C (°C)	Maximum Temperature Range (°C)	Vcc Range (V)	Maximum Supply Current (µA)	Features	Packages
TC642	Fan Manager	Note 1	Note 1	-40 to +85	+3.0 to +5.5	1,000	FanSense™ Fan Monitor, minimum fan speed control	8-Pin PDIP, 8-Pin SOIC, 8-Pin MSOP
TC642B	Fan Manager	Note 1	Note 1	-40 to +85	+3.0 to +5.5	400	FanSense™ Fan Monitor, minimum fan speed control, fan auto-restart	8-Pin PDIP, 8-Pin SOIC, 8-Pin MSOP
TC646	Fan Manager	Note 1	Note 1	-40 to +85	+3.0 to +5.5	1,000	FanSense™ Fan Monitor, auto-shutdown	8-Pin PDIP, 8-Pin SOIC, 8-Pin MSOP
TC646B	Fan Manager	Note 1	Note 1	-40 to +85	+3.0 to +5.5	400	FanSense™ Fan Monitor, auto-shutdown, fan auto-restart	8-Pin PDIP, 8-Pin SOIC, 8-Pin MSOP
TC647	Fan Manager	Note 1	Note 1	-40 to +85	+3.0 to +5.5	1,000	FanSense™ Fan Monitor, minimum fan speed control	8-Pin PDIP, 8-Pin SOIC, 8-Pin MSOP
TC647B	Fan Manager	Note 1	Note 1	-40 to +85	+3.0 to +5.5	400	FanSense™ Fan Monitor, minimum fan speed control, fan auto-restart	8-Pin PDIP, 8-Pin SOIC, 8-Pin MSOP
TC648	Fan Manager	Note 1	Note 1	-40 to +85	+3.0 to +5.5	1,000	Over-temperature alert, auto-shutdown	8-Pin PDIP, 8-Pin SOIC, 8-Pin MSOP
TC648B	Fan Manager	Note 1	Note 1	-40 to +85	+3.0 to +5.5	400	Over-temperature alert, auto-shutdown, fan auto-restart	8-Pin PDIP, 8-Pin SOIC, 8-Pin MSOP
TC649	Fan Manager	Note 1	Note 1	-40 to +85	+3.0 to +5.5	1,000	FanSense™ Fan Monitor, auto-shutdown	8-Pin PDIP, 8-Pin SOIC, 8-Pin MSOP

NOTE 1: These devices use an external temperature sensor. Accuracy of the total solution is a function of the accuracy of the external sensor.

THERMAL MANAGEMENT PRODUCTS – Brushless DC Fan Controllers and Fan Fault Detectors

Part #	Description	Typical Accuracy (°C)	Maximum Accuracy @ 25°C (°C)	Maximum Temperature Range (°C)	Vcc Range (V)	Maximum Supply Current (μA)	Features	Packages
TC649B	Fan Manager	Note 1	Note 1	-40 to +85	+3.0 to +5.5	400	FanSense™ Fan Monitor, auto-shutdown, fan auto-restart	8-Pin PDIP, 8-Pin SOIC, 8-Pin MSOP
TC650	Fan Manager	±1	±3	-40 to +125	+2.8 to +5.5	90	Over-temperature alert	8-Pin MSOP
TC651	Fan Manager	±1	±3	-40 to +125	+2.8 to +5.5	90	Over-temperature alert, auto-shutdown	8-Pin MSOP
TC652	Fan Manager	±1	±3	-40 to +125	+2.8 to +5.5	90	FanSense™ Fan Monitor, over-temperature alert	8-Pin MSOP
TC653	Fan Manager	±1	±3	-40 to +125	+2.8 to +5.5	90	FanSense™ Fan Monitor, over-temperature alert, auto-shutdown	8-Pin MSOP
TC654	Dual SMBus Fan Manager	Note 1	Note 1	-40 to +85	+3.0 to +5.5	320	FanSense™ Fan Monitor, RPM data	10-Pin MSOP
TC655	Dual SMBus Fan Manager	Note 1	Note 1	-40 to +85	+3.0 to +5.5	320	FanSense™ Fan Monitor, RPM data, over-temperature alert	10-Pin MSOP
TC664	Single SMBus Fan Manager	Note 1	Note 1	-40 to +85	+3.0 to +5.5	320	FanSense™ Fan Monitor, RPM data	10-Pin MSOP
TC665	Single SMBus Fan Manager	Note 1	Note 1	-40 to +85	+3.0 to +5.5	320	FanSense™ Fan Monitor, RPM data, over-temperature alert	10-Pin MSOP
TC670	Predictive Fan Fault Detector	N/A	N/A	-40 to +85	+3.0 to +5.5	150	FanSense™ Fan Monitor, programmable threshold	6-Pin SOT-23

NOTE 1: These devices use an external temperature sensor. Accuracy of the total solution is a function of the accuracy of the external sensor.

POWER MANAGEMENT – Voltage References

Part #	Vcc Range (V)	Output Voltage (V)	Max. Load Current (mA)	Initial Accuracy (max.%)	Temperature Coefficient (ppm/°C)	Max. Supply Current (μA @ 25°C)	Packages
MCP1525	2.7 to 5.5	2.5	±2	±1	50	100	3-Pin TO-92, 3-Pin SOT-23B
MCP1541	4.3 to 5.5	4.096	±2	±1	50	100	3-Pin TO-92, 3-Pin SOT-23B

POWER MANAGEMENT – Linear Regulators

Part #	Max. Input Voltage (V)	Output Voltage (V)	Output Current (mA)	Junction Temperature Range (°C)	Typical Active Current (μA)	Typical Dropout Voltage @ Max. I _{OUT} (mV)	Typical Output Voltage Accuracy (%)	Features	Packages
50 mA to 250 mA Low Dropout Linear Regulators									
TC2014	6.0	1.8, 2.7, 2.8, 3.0, 3.3	50	-40 to +125	55	45	±0.4	Shutdown, Reference bypass input	5-Pin SOT-23A
TC1014	6.0	1.8, 2.5, 2.7, 2.8, 2.85, 3.0, 3.3, 3.6, 4.0, 5.0	50	-40 to +125	50	85	±0.5	Shutdown, Reference bypass input	5-Pin SOT-23A
TC2054	6.0	1.8, 2.7, 2.8, 3.0, 3.3	50	-40 to +125	55	45	±0.4	Shutdown, Error output	5-Pin SOT-23A

NOTE 1: Depending on external transistor configuration.
NOTE 2: Each channel (for Dual and Quad LDOs).
NOTE 3: LDOs with shutdown except TC56 and TC57 have typical shutdown currents of 0.05 μA.

Analog/Interface Family Products

POWER MANAGEMENT – Linear Regulators

Part #	Max. Input Voltage (V)	Output Voltage (V)	Output Current (mA)	Junction Temperature Range (°C)	Typical Active Current (µA)	Typical Dropout Voltage @ Max. I _{OUT} (mV)	Typical Output Voltage Accuracy (%)	Features	Packages
50 mA to 250 mA Low Dropout Linear Regulators (continued)									
TC1054	6.0	1.8, 2.5, 2.7, 2.8, 2.85, 3.0, 3.3, 3.6, 4.0, 5.0	50	-40 to +125	50	85	±0.5	Shutdown, Error output	5-Pin SOT-23A
TC1070	6.0	1.23 → V _{IN}	50	-40 to +125	50	85	—	Shutdown, Adjustable	5-Pin SOT-23A
TC1072	6.0	2.5, 2.7, 2.8, 2.85, 3.0, 3.3, 3.6, 4.0, 5.0	50	-40 to +125	50	85	±0.5	Shutdown, Reference bypass input, Error output	6-Pin SOT-23A
TC1223	6.0	2.5, 2.7, 2.8, 3.0, 3.3, 3.6, 4.0, 5.0	50	-40 to +125	50	85	±0.5	Shutdown	5-Pin SOT-23A
TC1016	6.0	1.8, 2.7, 2.8, 3.0	80	-40 to +125	50	150	±0.5	Shutdown	5-Pin SC-70
TC2015	6.0	1.8, 2.7, 2.8, 3.0, 3.3	100	-40 to +125	55	90	±0.4	Shutdown, Reference bypass input	5-Pin SOT-23A
TC1015	6.0	1.8, 2.5, 2.7, 2.8, 2.85, 3.0, 3.3, 3.6, 4.0, 5.0	100	-40 to +125	50	180	±0.5	Shutdown, Reference bypass input	5-Pin SOT-23A
TC2055	6.0	1.8, 2.7, 2.8, 3.0, 3.3	100	-40 to +125	55	90	±0.4	Shutdown, Error output	5-Pin SOT-23A
TC1055	6.0	1.8, 2.5, 2.7, 2.8, 2.85, 3.0, 3.3, 3.6, 4.0, 5.0	100	-40 to +125	50	180	±0.5	Shutdown, Error output	5-Pin SOT-23A
TC1071	6.0	1.23 → V _{IN}	100	-40 to +125	50	180	—	Shutdown, Adjustable	5-Pin SOT-23A
TC1073	6.0	2.5, 2.7, 2.8, 2.85, 3.0, 3.3, 3.6, 4.0, 5.0	100	-40 to +125	50	180	±0.5	Shutdown, Reference bypass input, Error output	6-Pin SOT-23A
TC1224	6.0	2.5, 2.7, 2.8, 3.0, 3.3, 3.6, 4.0, 5.0	100	-40 to +125	50	180	±0.5	Shutdown	5-Pin SOT-23A
TC1188	6.0	1.8, 2.8, 2.84, 3.15	120	-40 to +125	50	130	±0.5	Shutdown	5-Pin SOT-23A
TC1189	6.0	1.8, 2.8, 2.84, 3.15	120	-40 to +125	50	130	±0.5	Shutdown	5-Pin SOT-23A
TC2185	6.0	1.8, 2.7, 2.8, 3.0, 3.3	150	-40 to +125	55	140	±0.4	Shutdown, Reference bypass input	5-Pin SOT-23A
TC1185	6.0	1.8, 2.5, 2.7, 2.8, 2.85, 3.0, 3.3, 3.6, 4.0, 5.0	150	-40 to +125	50	270	±0.5	Shutdown, Reference bypass input	5-Pin SOT-23A
TC2186	6.0	1.8, 2.7, 2.8, 3.0, 3.3	150	-40 to +125	55	140	±0.4	Shutdown, Error output	5-Pin SOT-23A
TC1186	6.0	1.8, 2.5, 2.7, 2.8, 2.85, 3.0, 3.3, 3.6, 4.0, 5.0	150	-40 to +125	50	270	±0.5	Shutdown, Error output	5-Pin SOT-23A
TC1187	6.0	1.23 → V _{IN}	150	-40 to +125	50	270	—	Shutdown, Adjustable	5-Pin SOT-23A
TC1017	6.0	1.8, 2.6, 2.7, 2.8, 2.85, 2.9, 3.3, 3.4	150	-40 to +125	53	285	±0.5	Shutdown	5-Pin SOT-23A, 5-Pin SC-70
TC56 ⁽³⁾	10	2.5, 3.0, 3.3	180	-40 to +85	11	330	±0.5	Shutdown	5-Pin SOT-23A
MCP1700	6.0	1.2, 1.8, 2.5, 3.0, 3.3, 5.0	250	-40 to +125	1.0	300	±0.4	1.0 µF ceramic cap stable, Short-circuit protection	3-Pin TO-92, 3-Pin SOT-23A, 3-Pin SOT-89
MCP1701	10	1.8, 2.5, 3.0, 3.3, 5.0	250	-40 to +85	1.1	380	±0.5	10V max. input voltage	3-Pin SOT-23A, 3-Pin SOT-89, 3-Pin TO-92

- NOTE** 1: Depending on external transistor configuration.
 2: Each channel (for Dual and Quad LDOs).
 3: LDOs with shutdown except TC56 and TC57 have typical shutdown currents of 0.05 µA.

POWER MANAGEMENT – Linear Regulators

Part #	Max. Input Voltage (V)	Output Voltage (V)	Output Current (mA)	Junction Temperature Range (°C)	Typical Active Current (µA)	Typical Dropout Voltage @ Max. I _{OUT} (mV)	Typical Output Voltage Accuracy (%)	Features	Packages
300 mA Low Dropout Linear Regulators									
TC1107	6.0	2.5, 2.7, 2.8, 3.0, 3.3, 5.0	300	-40 to +125	50	240	±0.5	Shutdown, Reference bypass input	8-Pin MSOP, 8-Pin SOIC
TC1108	6.0	2.5, 2.7, 2.8, 3.0, 3.3, 5.0	300	-40 to +125	50	240	±0.5		3-Pin SOT-223
TC1173	6.0	2.5, 2.7, 2.8, 3.0, 3.3, 5.0	300	-40 to +125	50	240	±0.5	Shutdown, Reference bypass input, Error output	8-Pin MSOP, 8-Pin SOIC
TC1174	6.0	1.23 → V _{IN}	300	-40 to +125	50	240	—	Shutdown, Reference bypass input, Adjustable	8-Pin MSOP, 8-Pin SOIC
TC1269	6.0	2.5, 2.8, 3.0, 3.3, 5.0	300	-40 to +125	50	240	±0.5	Shutdown, Reference bypass input	8-Pin MSOP
500 mA to 800 mA Low Dropout Linear Regulators									
TC1262	6.0	2.5, 2.8, 3.0, 3.3, 5.0	500	-40 to +125	80	350	±0.5		3-Pin TO-220, 3-Pin DDPAK, 3-Pin SOT-223
TC1263	6.0	2.5, 2.8, 3.0, 3.3, 5.0	500	-40 to +125	80	350	±0.5	Shutdown, Reference bypass input, Error output	8-Pin SOIC, 5-Pin TO-220, 5-Pin DDPAK
TC1268	6.0	2.5	500	-40 to +125	80	350	±0.5	Shutdown, Reference bypass input, Error output	8-Pin SOIC
TC1264	6.0	1.8, 2.5, 3.0, 3.3	800	-40 to +125	80	450	±0.5		3-Pin TO-220, 3-Pin DDPAK, 3-Pin SOT-223
TC1265	6.0	1.8, 2.5, 3.0, 3.3	800	-40 to +125	80	450	±0.5	Shutdown, Reference bypass input, Error output	8-Pin SOIC, 5-Pin TO-220, 5-Pin DDPAK
TC2117	6.0	1.8, 2.5, 3.0, 3.3	800	-40 to +125	80	600	±0.5		3-Pin SOT-223, 3-Pin DDPAK
1A and Above Low Dropout Linear Regulators									
MCP1726	6.0	Fixed: 5, 3.3, 3, 2.5, 1.8, 1.2 Adjustable: .8 to 5.0	1000	-40 to +125	140	300	±0.4	Shutdown, Cdelay, Power-Good	8-Pin 3x3 DFN, 8-Pin SOIC
Application Specific Low Dropout Linear Regulators									
TC1266	6.0	3.3	200	-5 to +70	230	200	±1.0	PCI compliant	8-Pin SOIC, 8-Pin MSOP
TC1267	6.0	3.3	400	-5 to +70	230	300	±1.0	PCI compliant	5-Pin DDPAK
TC57 ⁽³⁾	8	2.5, 3.0, 3.3	4,000 ⁽¹⁾	-40 to +85	50	100 ⁽¹⁾	±2.0	Shutdown, External transistor	5-Pin SOT-23A
TC59	-10	-3.0, -5.0	100	-40 to +85	3	380	±0.5	Negative LDO	3-Pin SOT-23A
Power Management Combination Products									
TC1300	6.0	2.5, 2.7, 2.8, 2.85, 3.0, 3.3	300	-40 to +125	80	210	±0.5	Shutdown, Reference bypass input, LDO plus Reset output	8-Pin MSOP
TC1301A	6.0	LDO1: 1.5-3.3 LDO2: 1.5-3.3	LDO1: 300 LDO2: 150	-40 to +125	103	LDO1: 104 LDO2: 150	±0.5	Dual LDO plus Reset output, Shutdown, Reference bypass, Voltage detect	8-Pin MSOP, 8-Pin 3x3 DFN
TC1301B	6.0	LDO1: 1.5-3.3 LDO2: 1.5-3.3	LDO1: 300 LDO2: 150	-40 to +125	114	LDO1: 104 LDO2: 150	±0.5	Dual LDO plus Reset, Per channel output shutdown, Reference bypass	8-Pin MSOP, 8-Pin 3x3 DFN

NOTE 1: Depending on external transistor configuration.
2: Each channel (for Dual and Quad LDOs).
3: LDOs with shutdown except TC56 and TC57 have typical shutdown currents of 0.05 µA.

Analog/Interface Family Products

POWER MANAGEMENT – Linear Regulators

Part #	Max. Input Voltage (V)	Output Voltage (V)	Output Current (mA)	Junction Temperature Range (°C)	Typical Active Current (µA)	Typical Dropout Voltage @ Max. I _{OUT} (mV)	Typical Output Voltage Accuracy (%)	Features	Packages
Power Management Combination Products (continued)									
TC1302A	6.0	LDO1: 1.5-3.3 LDO2: 1.5-3.3	LDO1: 300 LDO2: 150	-40 to +125	103	LDO1: 104 LDO2: 150	±0.5	Dual LDO, Output shutdown reference bypass, Voltage detect	8-Pin MSOP, 8-Pin 3x3 DFN
TC1302B	6.0	LDO1: 1.5-3.3 LDO2: 1.5-3.3	LDO1: 300 LDO2: 150	-40 to +125	114	LDO1: 104 LDO2: 150	±0.5	Dual LDO, Per channel output shutdown, Reference bypass	8-Pin MSOP, 8-Pin 3x3 DFN
TC1305	6.0	2.5, 2.8, 3.0	150 ⁽²⁾	-40 to +125	120	240	±0.5	Dual LDO plus Reset output, Reference bypass input, Shutdown, Select Mode™ selectable output voltages	10-Pin MSOP
TC1306	6.0	1.8, 2.8, 3.0	150 ⁽²⁾	-40 to +125	120	240	±0.5	Dual LDO plus Reset output, Shutdown, Select Mode™ selectable output voltages	8-Pin MSOP
TC1307	6.0	1.8, 2.5, 2.8, 3.0	150 ⁽²⁾	-40 to +125	220	200	±0.5	Quad LDO plus Reset output, Shutdown, Select Mode™ selectable output voltage	16-Pin QSOP

- NOTE** 1: Depending on external transistor configuration.
 2: Each channel (for Dual and Quad LDOs).
 3: LDOs with shutdown except TC56 and TC57 have typical shutdown currents of 0.05 µA.

POWER MANAGEMENT – Switching Regulators

Part #	Description	Input Voltage Range (V)	Output Voltage (V)	Operating Temperature Range (°C)	Control Scheme	Switching Frequency (kHz)	Typical Active Supply (µA)	Output Current (mA)	Features	Packages
MCP1601	Synchronous Buck Regulator	2.7 to 5.5	0.9V to V _{IN}	-40 to +85	PFM/PWM/ LDO	750	825 (PWM) 125 (PFM)	500	UVLO, Auto-switching, LDO	8-Pin MSOP
MCP1650	Step-up DC/DC controller	2.7 to 5.5	2.5 to ext. tx limited	-40 to +125	Constant frequency, 2 fixed DC	750	0.12	560/440	2 duty cycles for min. and max. loads, shutdown control, UVLO, soft start	8-Pin MSOP
MCP1651	Step-up DC/DC controller	2.7 to 5.5	2.5 to ext. tx limited	-40 to +125	Constant frequency, 2 fixed DC	750	0.12	560/440	2 duty cycles for min. and max. loads, shutdown control, low battery detect, UVLO, soft start	8-Pin MSOP
MCP1652	Step-up DC/DC controller	2.7 to 5.5	2.5 to ext. tx limited	-40 to +125	Constant frequency, 2 fixed DC	750	0.12	560/440	2 duty cycles for min. and max. loads, shutdown control, power-good indicator, UVLO, soft start	8-Pin MSOP
MCP1653	Step-up DC/DC controller	2.7 to 5.5	2.5 to ext. tx limited	-40 to +125	Constant frequency, 2 fixed DC	750	0.12	560/440	2 duty cycles for min. and max. loads, shutdown control, low battery detect, power-good indicator, UVLO, soft start	10-Pin MSOP
TC105	Step-down DC/DC Controller	2.2 to 10	3.0, 3.3, 5.0	-40 to +85	PFM/PWM	300	57	1,000	Low-Power Shutdown mode	5-Pin SOT-23A
TC120	Step-down Regulator/Controller Combination	1.8 to 10	3.0, 3.3, 5.0	-40 to +85	PFM/PWM	300	52	2,000	Soft-start, Low-Power Shutdown mode	8-Pin SOP
TC125	Step-up DC/DC Regulator	0.9 to 10	3.0, 3.3, 5.0	-40 to +85	PFM	100	20	80	Low-Power Shutdown mode	5-Pin SOT-23A
TC126	Step-up DC/DC Regulator	0.9 to 10	3.0, 3.3, 5.0	-40 to +85	PFM	100	20	80	Feedback voltage sensing	5-Pin SOT-23A
TC115	Step-up DC/DC Regulator	0.9 to 10	3.0, 3.3, 5.0	-40 to +85	PFM/PWM	100	80	140	Feedback voltage sensing, Low-Power Shutdown mode	5-Pin SOT-89

POWER MANAGEMENT – Switching Regulators

Part #	Description	Input Voltage Range (V)	Output Voltage (V)	Operating Temperature Range (°C)	Control Scheme	Switching Frequency (kHz)	Typical Active Supply (µA)	Output Current (mA)	Features	Packages
TC110	Step-up DC/DC Controller	2.0 to 10	3.0, 3.3, 5.0	-40 to +85	PFM/PWM	100/300	50/120	300	Soft-start, Low-Power Shutdown mode	5-Pin SOT-23A

POWER MANAGEMENT – PWM Controllers

Part #	Description	Input Voltage Range (V)	Output Voltage (V)	Operating Temperature Range (°C)	Control Scheme	Switching Frequency (kHz)	Typical Active Supply (µA)	Output Current (mA)	Features	Packages
MCP1630	High speed PWM to use with PIC® MCUs	2.7 to 5.5	V _{SS} + 0.2V to V _{DD} - 0.2V	-40 to +125	Cycle-by-Cycle DC control	1000	3.5	±10	UVLO, current sense to V _{EXT} , response <25 ns	8-Pin MSOP

POWER MANAGEMENT – Charge Pump DC-to-DC Converters

Part #	Input Voltage Range (V)	Output Voltage (V)	Operating Temperature Range (°C)	Maximum Input Current ⁽¹⁾ (µA)	Typical Active Output Current (mA)	Features	Packages
Inverting or Doubling Charge Pumps							
TC1044S	1.5 to 12	V _{OUT} = -V _{IN} or V _{OUT} = 2 V _{IN}	-40 to +85	160	20	85 kHz oscillator, Boost mode	8-Pin PDIP, 8-Pin SOIC
TC7660	1.5 to 10	V _{OUT} = -V _{IN} or V _{OUT} = 2 V _{IN}	-40 to +85	180	20	10 kHz oscillator	8-Pin PDIP, 8-Pin SOIC
TC7660H	1.5 to 10	V _{OUT} = -V _{IN} or V _{OUT} = 2 V _{IN}	-40 to +85	1,000	20	120 kHz oscillator	8-Pin PDIP, 8-Pin SOIC
TC7660S	1.5 to 12	V _{OUT} = -V _{IN} or V _{OUT} = 2 V _{IN}	-40 to +85	160	20	45 kHz oscillator, Boost mode	8-Pin PDIP, 8-Pin SOIC
TC7662B	1.5 to 15	V _{OUT} = -V _{IN} or V _{OUT} = 2 V _{IN}	-40 to +85	180	20	35 kHz oscillator, Boost mode	8-Pin PDIP, 8-Pin SOIC
TC1219	1.5 to 5.5	V _{OUT} = -V _{IN} or V _{OUT} = 2 V _{IN}	-40 to +85	115	25	12 kHz oscillator, Low-Power Shutdown mode	6-Pin SOT-23A
TC1220	1.5 to 5.5	V _{OUT} = -V _{IN} or V _{OUT} = 2 V _{IN}	-40 to +85	325	25	35 kHz oscillator, Low-Power Shutdown mode	6-Pin SOT-23A
TC1221	1.8 to 5.5	V _{OUT} = -V _{IN} or V _{OUT} = 2 V _{IN}	-40 to +85	600	25	Shutdown, 125 kHz oscillator	6-Pin SOT-23A
TC1222	1.8 to 5.5	V _{OUT} = -V _{IN} or V _{OUT} = 2 V _{IN}	-40 to +85	2,800	25	Shutdown, 750 kHz oscillator	6-Pin SOT-23A
TCM828	1.5 to 5.5	V _{OUT} = -V _{IN} or V _{OUT} = 2 V _{IN}	-40 to +85	90	25	12 kHz oscillator	5-Pin SOT-23A
TCM829	1.5 to 5.5	V _{OUT} = -V _{IN} or V _{OUT} = 2 V _{IN}	-40 to +85	260	25	35 kHz oscillator	5-Pin SOT-23A
TC1240	2.5 to 4.0	V _{OUT} = 2 V _{IN}	-40 to +85	900	40	Shutdown, 160 kHz oscillator	6-Pin SOT-23A
TC1240A	2.5 to 5.5	V _{OUT} = 2 V _{IN}	-40 to +85	900	40	Shutdown, 160 kHz oscillator	6-Pin SOT-23A
TC7662A	3 to 18	V _{OUT} = -V _{IN} or V _{OUT} = 2V _{IN}	-40 to +85	200	40	12 kHz oscillator	8-Pin PDIP
TC962	3 to 18	V _{OUT} = -V _{IN} or V _{OUT} = 2 V _{IN}	-40 to +85	200	80		8-Pin PDIP, 16-Pin SOIC
TC1121	2.4 to 5.5	V _{OUT} = -V _{IN} or V _{OUT} = 2 V _{IN}	-40 to +85	100	100	Low-Power Shutdown mode	8-Pin MSOP, 8-Pin PDIP, 8-Pin SOIC
Multi-Function Charge Pumps							
TCM680	2.0 to 5.5	V _{OUT} = ±2 V _{IN}	-40 to +85	1,000	±10	Generates ±6V from +3V or ±10V from +5V	8-Pin PDIP, 8-Pin SOIC

NOTE 1: Measured at V_{DD} = 5.0V at 25°C and no load.

Analog/Interface Family Products

POWER MANAGEMENT – Charge Pump DC-to-DC Converters

Part #	Input Voltage Range (V)	Output Voltage (V)	Operating Temperature Range (°C)	Maximum Input Current ⁽¹⁾ (µA)	Typical Active Output Current (mA)	Features	Packages
Inverting and Doubling Charge Pumps							
TC682	2.4 to 5.5	V _{OUT} = -2 V _{IN}	-40 to +85	400	10	12 kHz oscillator	8-Pin PDIP, 8-Pin SOIC
Regulated Charge Pumps							
TC1142	2.5 to 5.5	-3V to -5V	-40 to +85	400	20	Regulated GaAs FET supply, Internal 200 kHz oscillator, External clock 3 kHz to 500 kHz, Low-Power Shutdown mode	8-Pin MSOP
MCP1252	2.1/2.7 to 5.5 2.0 to 5.5	Selectable 3.3V or 5.0V or Adjustable 1.5V to 5.5V	-40 to +85	120	120 mA for V _{IN} >3.0V	Power-Good output, 650 kHz oscillator	8-Pin MSOP
MCP1253	2.1/2.7 to 5.5 2.0 to 5.5	Selectable 3.3V or 5.0V or Adjustable 1.5V to 5.5V	-40 to +85	120	120 mA for V _{IN} >3.0V	Power-Good output, 1 MHz oscillator	8-Pin MSOP

NOTE 1: Measured at V_{DD} = 5.0V at 25°C and no load.

POWER MANAGEMENT – CPU/System Supervisors

Part #	V _{CC} Range (V)	Operating Temperature Range (°C)	Nominal Reset Voltage (V)	Reset Type	Output	Typical Reset Pulse Width (ms)	Typical Supply Current (µA)	Additional Features	Packages	Bond Options
MCP102	1V-5.5V	-40 to 125	1.9, 2.32, 2, 63, 2.93, 3.08, 4.38, 4.63	Active Low	CMOS Push-Pull	120	1		3-Pin SOT-23B, 3-Pin SC-70, 3-Pin TO-92	N/A
MCP103	1V-5.5V	-40 to 125	1.9, 2.32, 2, 63, 2.93, 3.08, 4.38, 4.63	Active Low	CMOS Push-Pull	120	1	Max. 809 Pinout	3-Pin SOT-23B, 3-Pin SC-70, 3-Pin TO-92	N/A
TC1272	1.2-5.5	-40 to +85	4.62, 4.37, 4.12	Active Low	CMOS Push-Pull	200	17		3-Pin SOT-23B	N/A
TC1275	1.2-5.5	-40 to +85	3.06, 2.88, 2.55	Active Low	CMOS Push-Pull	200	20		3-Pin SOT-23B	N/A
TCM809	1.2-5.5	-40 to +85	4.63, 4.38, 4.00, 3.08, 2.93, 2.63, 2.32	Active Low	CMOS Push-Pull	240	12		3-Pin SOT-23B, 3-Pin SC-70	N/A
TC1270	1.2-5.5	-40 to +85	4.63, 4.38, 3.08, 2.93, 2.63, 1.75	Active Low	CMOS Push-Pull	280	7	Manual Reset	4-Pin SOT-143	N/A
TCM811	1.0-5.5	-40 to +85	4.63, 4.38, 3.08, 2.93, 2.63, 1.75	Active Low	CMOS Push-Pull	280	6	Manual Reset	4-Pin SOT-143	N/A
MCP100	1.0-5.5	-40 to +85	4.72, 4.62, 4.47, 4.37, 3.075, 2.92, 2.62	Active Low	CMOS Push-Pull	350	45		3-Pin TO-92, 3-Pin SOT-23B	D, H
MCP809	1.0-5.5	-40 to +85	4.72, 4.62, 4.47, 4.37, 3.075, 2.92, 2.62	Active Low	CMOS Push-Pull	350	45		3-Pin SOT-23B	N/A
TC1274	1.8-5.5	-40 to +85	4.62, 4.37, 4.13	Active High	CMOS Push-Pull	200	17		3-Pin SOT-23B	N/A
TC1277	1.8-5.5	-40 to +85	3.06, 2.88, 2.55	Active High	CMOS Push-Pull	200	20		3-Pin SOT-23B	N/A
TCM810	1.2-5.5	-40 to +85	4.63, 4.38, 3.08, 2.93, 2.63, 2.32	Active High	CMOS Push-Pull	240	12		3-Pin SOT-23B, 3-Pin SC-70	N/A
TC1271	1.2-5.5	-40 to +85	4.63, 4.38, 3.08, 2.93, 2.63, 1.75	Active High	CMOS Push-Pull	280	7	Manual Reset	4-Pin SOT-143	N/A
TCM812	1.1-5.5	-40 to +85	4.63, 4.38, 3.08, 2.93, 2.63, 1.75	Active High	CMOS Push-Pull	280	6	Manual Reset	4-Pin SOT-143	N/A
MCP101	1.0-5.5	-40 to +85	4.72, 4.62, 4.47, 4.37, 3.075, 2.92, 2.62	Active High	CMOS Push-Pull	350	45		3-Pin TO-92, 3-Pin SOT-23B	D, H
MCP810	1.0-5.5	-40 to +85	4.72, 4.62, 4.47, 4.37, 3.075, 2.92, 2.62	Active High	CMOS Push-Pull	350	45		3-Pin SOT-23B	N/A
MCP121	1V-5.5V	-40 to 125	1.9, 2.32, 2, 63, 2.93, 3.08, 4.38, 4.63	Active Low	Open-drain	120	1		3-Pin SOT-23B, 3-Pin SC-70, 3-Pin TO-92	N/A
TC1273	1.2-5.5	-40 to +85	4.62, 4.37, 4.12	Active Low	Open-drain	200	17		3-Pin SOT-23B	N/A

POWER MANAGEMENT – CPU/System Supervisors

Part #	Vcc Range (V)	Operating Temperature Range (°C)	Nominal Reset Voltage (V)	Reset Type	Output	Typical Reset Pulse Width (ms)	Typical Supply Current (µA)	Additional Features	Packages	Bond Options
TC1276	1.2-5.5	-40 to +85	3.06, 2.88, 2.55	Active Low	Open-drain	200	20		3-Pin SOT-23B	N/A
MCP120	1.0-5.5	-40 to +85	4.72, 4.62, 4.47, 4.37, 3.075, 2.92, 2.62	Active Low	Open-drain	350	45		3-Pin TO-92, 3-Pin SOT-23, 8-Pin SOIC	D, G, H
TC1279	1.2-5.5	-40 to +85	4.62, 4.37, 4.125	Active Low	Open-drain	350	900		3-Pin SOT-23B	N/A
MCP131	1V-5.5V	-40 to 125	1.9, 2.32, 2, 63, 2.93, 3.08, 4.38, 4.63	Active Low	Open-drain	120	1	100kΩ Internal Pull-up Resistor	3-Pin SOT-23B, 3-Pin SC-70, 3-Pin TO-92	N/A
MCP130	1.0-5.5	-40 to +85	4.72, 4.62, 4.47, 4.37, 3.075, 2.92, 2.62	Active Low	Open-drain w/ 5 kΩ Pull-up	350	45		3-Pin TO-92, 3-Pin SOT-23, 8-Pin SOIC	D, F, H
TC1278	1.2-5.5	-40 to +85	4.62, 4.37, 4.125	Active High	Open-drain	350	900		3-Pin SOT-23B	N/A
TC1232	4.5-5.5	-40 to +85	4.62, 4.37	Active Low/High	Open-drain	610	50	Watchdog Timer	8-Pin PDIP, 8-Pin SOIC, 16-Pin SOIC	N/A
TC32M	4.5-5.5	-40 to +85	4.5	Active Low	Open-drain	700	50	Watchdog Timer	3-Pin TO-92, 3-Pin SOT-223	N/A

POWER MANAGEMENT – Voltage Detectors

Part #	Vcc Range (V)	Operating Temperature Range (°C)	Nominal Reset Voltage (V)	Reset Type	Output	Minimum Reset Pulse Width (ms)	Typical Supply Current (µA)	Features	Packages
MCP111	1.0 to 5.5	-40 to +125	4.63, 4.38, 3.08, 2.93, 2.63, 2.32, 1.90	Active Low	Open-drain	—	1		3-Pin SOT-23B, 3-Pin TO-92, 3-Pin SC-70
MCP112	1.0 to 5.5	-40 to +125	4.63, 4.38, 3.08, 2.93, 2.63, 2.32, 1.90	Active Low	CMOS Push-Pull	—	1		3-Pin SOT-23B, 3-Pin TO-92, 3-Pin SC-70
TC51	0.7 to 10	-40 to +85	3.0, 2.7, 2.2	Active Low	Open-drain	50	1	Reset delay	3-Pin SOT-23A
TC52	1.5 to 10	-40 to +85	4.5/2.7, 3.0/2.7	Active Low	Open-drain	—	2	Dual channel	5-Pin SOT-23A
TC53	1.5 to 10	-40 to +85	2.9, 2.7, 2.2	Active Low	CMOS Push-Pull or Open-drain	—	1		5-Pin SOT-23A
TC54	0.7 to 10	-40 to +85	7.7, 4.3, 4.2, 3.0, 2.9, 2.7, 2.1, 1.4	Active Low	CMOS Push-Pull or Open-drain	—	1		3-Pin SOT-23A, 3-Pin SOT-89, 3-Pin TO-92

POWER MANAGEMENT – Power MOSFET Drivers

Part #	Configuration	Operating Temperature Range (°C)	Peak Output Current (A)	Output Resistance (RH/RL) (Max. Ω @ 25°C)	Max. Supply Voltage (V)	Input/Output Delay (td1, td2) ⁽¹⁾ (ns)	Packages
Low-Side Drivers, 0.5A to 1.2A Peak Output Current							
TC1410	Single, Inverting	-40 to +85	0.5	22/22	16	30/30	8-Pin PDIP, 8-Pin SOIC, 8-Pin MSOP
TC1410N	Single, Non-inverting	-40 to +85	0.5	22/22	16	30/30	8-Pin PDIP, 8-Pin SOIC, 8-Pin MSOP
TC1411	Single, Inverting	-40 to +85	1	11/11	16	30/30	8-Pin PDIP, 8-Pin SOIC, 8-Pin MSOP
TC1411N	Single, Non-inverting	-40 to +85	1	11/11	16	30/30	8-Pin PDIP, 8-Pin SOIC, 8-Pin MSOP
TC1426	Dual, Inverting	0 to +70	1.2	18/18	16	75/75	8-Pin PDIP, 8-Pin SOIC
TC1427	Dual, Non-inverting	0 to +70	1.2	18/18	16	75/75	8-Pin PDIP, 8-Pin SOIC

NOTE 1: *td1 = delay time from input low-to-high transition to output transition. td2 = delay time from input high-to-low transition to output transition.

Analog/Interface Family Products

POWER MANAGEMENT – Power MOSFET Drivers

Part #	Configuration	Operating Temperature Range (°C)	Peak Output Current (A)	Output Resistance (RH/RL) (Max. Ω @ 25°C)	Max. Supply Voltage (V)	Input/Output Delay (td1, td2) ⁽¹⁾ (ns)	Packages
Low-Side Drivers, 0.5A to 1.2A Peak Output Current (continued)							
TC1428	Dual, Inverting and Non-inverting	0 to +70	1.2	18/18	16	75/75	8-Pin PDIP, 8-Pin SOIC
TC4467	Quad, Inverting	-40 to +85	1.2	15/15	18	40/40	14-Pin PDIP, 16-Pin SOIC (W)
TC4468	Quad, Non-inverting	-40 to +85	1.2	15/15	18	40/40	14-Pin PDIP, 16-Pin SOIC (W)
TC4469	Quad, Non-inverting	-40 to +85	1.2	15/15	18	40/40	14-Pin PDIP, 16-Pin SOIC (W)
Low-Side Drivers, 1.5A Peak Output Current							
TC4403	Single, Non-inverting Floating Load Driver	-40 to +85	1.5	5/5	18	33/38	8-Pin PDIP
TC4426A	Dual, Inverting	-40 to +125	1.5	9/9	18	30/30	8-Pin PDIP, 8-Pin SOIC, 8-Pin DFN
TC4427A	Dual, Non-inverting	-40 to +125	1.5	9/9	18	30/30	8-Pin PDIP, 8-Pin SOIC, 8-Pin DFN
TC4428A	Dual, Inverting and Non-inverting	-40 to +125	1.5	9/9	18	30/30	8-Pin PDIP, 8-Pin SOIC, 8-Pin DFN
TC4426	Dual, Inverting	-40 to +125	1.5	10/10	18	20/40	8-Pin PDIP, 8-Pin SOIC, 8-Pin DFN, 8-Pin MSOP
TC4427	Dual, Non-inverting	-40 to +125	1.5	10/10	18	20/40	8-Pin PDIP, 8-Pin SOIC, 8-Pin DFN, 8-Pin MSOP
TC4428	Dual, Inverting and Non-inverting	-40 to +125	1.5	10/10	18	20/40	8-Pin PDIP, 8-Pin SOIC, 8-Pin DFN, 8-Pin MSOP
TC426	Dual, Inverting	-40 to +85	1.5	15/10	18	50/75	8-Pin PDIP, 8-Pin SOIC
TC427	Dual, Non-inverting	-40 to +85	1.5	15/10	18	50/75	8-Pin PDIP, 8-Pin SOIC
TC428	Dual, Inverting and Non-inverting	-40 to +85	1.5	15/10	18	50/75	8-Pin PDIP, 8-Pin SOIC
TC4404	Dual, Inverting	-40 to +85	1.5	10/10	18	15/32	8-Pin PDIP, 8-Pin SOIC
TC4405	Dual, Non-inverting	-40 to +85	1.5	10/10	18	15/32	8-Pin PDIP, 8-Pin SOIC
Low-Side Drivers, 2.0A to 9.0A Peak Output Current							
TC1412	Single, Inverting	-40 to +85	2	6/6	16	35/35	8-Pin PDIP, 8-Pin SOIC, 8-Pin MSOP
TC1412N	Single, Non-inverting	-40 to +85	2	6/6	16	35/35	8-Pin PDIP, 8-Pin SOIC, 8-Pin MSOP
TC1413	Single, Inverting	-40 to +85	3	4/4	16	35/35	8-Pin PDIP, 8-Pin SOIC, 8-Pin MSOP
TC1413N	Single, Non-inverting	-40 to +85	3	4/4	16	35/35	8-Pin PDIP, 8-Pin SOIC, 8-Pin MSOP
TC4423	Dual, Inverting	-40 to +125	3	5/5	18	33/38	8-Pin PDIP, 16-Pin SOIC (W), 8-Pin DFN
TC4424	Dual, Non-inverting	-40 to +125	3	5/5	18	33/38	8-Pin PDIP, 16-Pin SOIC (W), 8-Pin DFN
TC4425	Dual, Inverting and Non-inverting	-40 to +125	3	5/5	18	33/38	8-Pin PDIP, 16-Pin SOIC (W), 8-Pin DFN
TC429	Single, Inverting	-40 to +85	6	2.5/2.5	18	53/60	8-Pin PDIP, 8-Pin DFN, 8-Pin SOIC
TC4420	Single, Non-inverting	-40 to +125	6	2.8/2.5	18	55/55	8-Pin PDIP, 8-Pin SOIC, 5-Pin TO-220, 8-Pin DFN
TC4429	Single, Inverting	-40 to +125	6	2.8/2.5	18	55/55	8-Pin PDIP, 8-Pin SOIC, 5-Pin TO-220, 8-Pin DFN
TC4421	Single, Inverting	-40 to +125	9	1.4 (typ)/1.7	18	30/33	8-Pin PDIP, 5-Pin TO-220, 8-Pin DFN
TC4422	Single, Non-inverting	-40 to +125	9	1.4 (typ)/1.7	18	30/33	8-Pin PDIP, 5-Pin TO-220, 8-Pin DFN

NOTE 1: *td1 = delay time from input low-to-high transition to output transition. td2 = delay time from input high-to-low transition to output transition.

POWER MANAGEMENT – Power MOSFET Drivers

Part #	Configuration	Operating Temperature Range (°C)	Peak Output Current (A)	Output Resistance (RH/RL) (Max. Ω @ 25°C)	Max. Supply Voltage (V)	Input/Output Delay (td1, td2) ⁽¹⁾ (ns)	Packages
High-Side/Low-Side Drivers							
TC4626	Single, Inverting	-40 to +85	1.5	15/10	6	35/45	8-Pin PDIP, 16-Pin SOIC (W)
TC4627	Single, Non-inverting	-40 to +85	1.5	15/10	6	35/45	8-Pin PDIP, 16-Pin SOIC (W)
TC4431	Single, Inverting	-40 to +85	1.5	10/10	30	62/78	8-Pin PDIP, 8-Pin SOIC
TC4432	Single, Non-inverting	-40 to +85	1.5	10/10	30	62/78	8-Pin PDIP, 8-Pin SOIC

NOTE 1: *td1 = delay time from input low-to-high transition to output transition. td2 = delay time from input high-to-low transition to output transition.

POWER MANAGEMENT – Battery Chargers

Part #	Mode	Cell Type	# of Cells	Vcc Range (V)	Max. Voltage Regulation (%)	Int/Ext FET	Features	Packages
MCP73826	Linear	Li Ion/Li Polymer	1	4.5 to 5.5	±1.0	Ext	Small size	6-Pin SOT-23
MCP73827	Linear	Li Ion/Li Polymer	1	4.5 to 5.5	±1.0	Ext	Mode indicator, Charge Current monitor	8-Pin MSOP
MCP73828	Linear	Li Ion/Li Polymer	1	4.5 to 5.5	±1.0	Ext	Temperature monitor	8-Pin MSOP
MCP73841	Linear	Li Ion/Li Polymer	1	4.5 to 12	±0.5	Ext	Safety charge timers, Temperature monitor	10-Pin MSOP
MCP73842	Linear	Li Ion/Li Polymer	2	8.7 to 12	±0.5	Ext	Safety charge timers, Temperature monitor	10-Pin MSOP
MCP73843	Linear	Li Ion/Li Polymer	1	4.5 to 12	±0.5	Ext	Safety charge timers	8-Pin MSOP
MCP73844	Linear	Li Ion/Li Polymer	2	8.7 to 12	±0.5	Ext	Safety charge timers	8-Pin MSOP
MCP73861	Linear	Li Ion/Li Polymer	1	4.5 to 12	±0.5	Int	Safety charge timers, Temperature monitor, Thermal regulation	16-pin 4x4 QFN
MCP73862	Linear	Li Ion/Li Polymer	2	8.7 to 12	±0.5	Int	Safety charge timers, Temperature monitor, Thermal regulation	16-pin 4x4 QFN

POWER MANAGEMENT – Hot Swap Controllers

Part #	Number of Outputs	Vpos to Vneg Differential Voltage (V)	Junction Temperature Range (°C)	OVLO	UVLO	Power Good	Int/Ext FET	Applications	Packages
MCP18480	1	-0.3 to +15.0	-40 to +85	Adjustable	Adjustable	Adjustable	Ext	-48V Telecom/Datacom, Bus/Backplane	20-Pin SSOP

LINEAR – Op Amps

Part #	# per Package	GBWP	Iq Typical (µA)	Vos Max (mV)	Operating Voltage (V)	Temp. Range (°C)	Features	Packages
TC1034	1	90 kHz	6	1.5	1.8 to 5.5	-40 to +85		5-Pin SOT-23A
TC1035	1	90 kHz	6	1.5	1.8 to 5.5	-40 to +85	Shutdown pin	6-Pin SOT-23A
TC1029	2	90 kHz	6	1.5	1.8 to 5.5	-40 to +85		8-Pin PDIP, 8-Pin MSOP, 8-Pin SOIC
TC1030	4	90 kHz	5	1.5	1.8 to 5.5	-40 to +85	Shutdown pins	16-Pin QSOP

NOTE: All TC10XX Op Amps have rail-to-rail inputs and outputs.

Analog/Interface Family Products

LINEAR – Op Amps

Part #	# per Package	GBWP	I _q Typical (μA)	V _{os} Max (mV)	Operating Voltage (V)	Temp. Range (°C)	Features	Packages
MCP6041	1	14 kHz	0.6	3	1.4 to 5.5	-40 to +85	Rail-to-Rail Input/Output	8-Pin PDIP, 8-Pin SOIC, 8-Pin MSOP, 5-Pin SOT-23
MCP6042	2	14 kHz	0.6	3	1.4 to 5.5	-40 to +85	Rail-to-Rail Input/Output	8-Pin PDIP, 8-Pin SOIC, 8-Pin MSOP
MCP6043	1	14 kHz	0.6	3	1.4 to 5.5	-40 to +85	Rail-to-Rail Input/Output, Chip Select	8-Pin PDIP, 8-Pin SOIC, 8-Pin MSOP
MCP6044	4	14 kHz	0.6	3	1.4 to 5.5	-40 to +85	Rail-to-Rail Input/Output	14-Pin PDIP, 14-Pin SOIC, 14-Pin TSSOP
MCP6141	1	100 kHz	0.6	3	1.4 to 5.5	-40 to +85	Rail-to-Rail Input/Output, G>10 stable	8-Pin PDIP, 8-Pin SOIC, 8-Pin MSOP
MCP6142	2	100 kHz	0.6	3	1.4 to 5.5	-40 to +85	Rail-to-Rail Input/Output, G>10 stable	8-Pin PDIP, 8-Pin SOIC, 8-Pin MSOP
MCP6143	1	100 kHz	0.6	3	1.4 to 5.5	-40 to +85	Rail-to-Rail Input/Output, G>10 stable, Chip Select	8-Pin PDIP, 8-Pin SOIC, 8-Pin MSOP
MCP6144	4	100 kHz	0.6	3	1.4 to 5.5	-40 to +85	Rail-to-Rail Input/Output, G>10 stable	14-Pin PDIP, 14-Pin SOIC, 14-Pin TSSOP
MCP606	1	155 kHz	19	0.25	2.5 to 5.5	-40 to +85	Rail-to-Rail Output	8-Pin PDIP, 8-Pin SOIC, 8-Pin TSSOP, 5-Pin SOT23
MCP607	2	155 kHz	19	0.25	2.5 to 5.5	-40 to +85	Rail-to-Rail Output	8-Pin PDIP, 8-Pin SOIC, 8-Pin TSSOP
MCP608	1	155 kHz	19	0.25	2.5 to 5.5	-40 to +85	Rail-to-Rail Output, Chip Select	8-Pin PDIP, 8-Pin SOIC, 8-Pin TSSOP
MCP609	4	155 kHz	19	0.25	2.5 to 5.5	-40 to +85	Rail-to-Rail Output	14-Pin PDIP, 14-Pin SOIC, 14-Pin TSSOP
MCP616	1	190 kHz	19	0.15	2.3 to 5.5	-40 to +85	Rail-to-Rail Output, PNP Input	8-Pin PDIP, 8-Pin SOIC, 8-Pin MSOP
MCP617	2	190 kHz	19	0.15	2.3 to 5.5	-40 to +85	Rail-to-Rail Output, PNP	8-Pin PDIP, 8-Pin SOIC, 8-Pin MSOP
MCP618	1	190 kHz	19	0.15	2.3 to 5.5	-40 to +85	Rail-to-Rail Output, Chip Select, PNP Input	8-Pin PDIP, 8-Pin SOIC, 8-Pin MSOP
MCP619	4	190 kHz	19	0.15	2.3 to 5.5	-40 to +85	Rail-to-Rail Output, PNP Input	14-Pin PDIP, 14-Pin SOIC, 14-Pin TSSOP
MCP6231	1	300 kHz	20	7	1.8 to 5.5	-40 to +125	Rail-to-Rail Input/Output	5-Pin SC-70, 5-Pin SOT-23, 8-Pin PDIP, 8-Pin SOIC, 8-Pin MSOP
MCP6232	2	300 kHz	20	7	1.8 to 5.5	-40 to +125	Rail-to-Rail Input/Output	8-Pin PDIP, 8-Pin SOIC, 8-Pin MSOP
MCP6241	1	650 kHz	50	7	1.8 to 5.5	-40 to +125	Rail-to-Rail Input/Output	5-Pin SC-70, 5-Pin SOT-23, 8-Pin PDIP, 8-Pin SOIC, 8-Pin MSOP
MCP6242	2	650 kHz	50	7	1.8 to 5.5	-40 to +125	Rail-to-Rail Input/Output	8-Pin PDIP, 8-Pin SOIC, 8-Pin MSOP
MCP6001	1	1 MHz	140	7	1.8 to 5.5	-40 to +125	Rail-to-Rail Input/Output	5-Pin SOT-23, 5-Pin SC-70
MCP6002	2	1 MHz	140	7	1.8 to 5.5	-40 to +125	Rail-to-Rail Input/Output	8-Pin PDIP, 8-Pin SOIC, 8-Pin MSOP
MCP6004	4	1 MHz	140	7	1.8 to 5.5	-40 to +125	Rail-to-Rail Input/Output	14-Pin PDIP, 14-Pin SOIC, 14-Pin TSSOP
MCP6271	1	2 MHz	170	3	2.0 to 5.5	-40 to +125	Rail-to-Rail Input/Output	8-Pin PDIP, 8-Pin SOIC, 8-Pin MSOP
MCP6272	2	2 MHz	170	3	2.0 to 5.5	-40 to +125	Rail-to-Rail Input/Output	8-Pin PDIP, 8-Pin SOIC, 8-Pin MSOP
MCP6273	1	2 MHz	170	3	2.0 to 5.5	-40 to +125	Rail-to-Rail Input/Output, Chip Select	8-Pin PDIP, 8-Pin SOIC, 8-Pin MSOP
MCP6274	4	2 MHz	170	3	2.0 to 5.5	-40 to +125	Rail-to-Rail Input/Output	14-Pin PDIP, 14-Pin SOIC, 14-Pin TSSOP
MCP6275	2	2 MHz	150	3	2.0 to 5.5	-40 to +125	Rail-to-Rail Input/Output, Dual connected, Chip Select	8-Pin PDIP, 8-Pin SOIC, 8-Pin MSOP
MCP601	1	2.8 MHz	230	2	2.7 to 5.5	-40 to +125	Rail-to-Rail Output	8-Pin PDIP, 8-Pin SOIC, 8-Pin TSSOP, 5-Pin SOT-23

NOTE: All TC10XX Op Amps have rail-to-rail inputs and outputs.

LINEAR – Op Amps

Part #	# per Package	GBWP	Iq Typical (µA)	Vos Max (mV)	Operating Voltage (V)	Temp. Range (°C)	Features	Packages
MCP602	2	2.8 MHz	230	2	2.7 to 5.5	-40 to +125	Rail-to-Rail Output	8-Pin PDIP, 8-Pin SOIC, 8-Pin TSSOP
MCP603	1	2.8 MHz	230	2	2.7 to 5.5	-40 to +125	Rail-to-Rail Output, Chip Select	8-Pin PDIP, 8-Pin SOIC, 8-Pin TSSOP
MCP604	4	2.8 MHz	230	2	2.7 to 5.5	-40 to +125	Rail-to-Rail Output	14-Pin PDIP, 14-Pin SOIC, 14-Pin TSSOP
MCP6281	1	5 MHz	445	3	2.2 to 5.5	-40 to +125	Rail-to-Rail Input/Output	8-Pin PDIP, 8-Pin SOIC, 8-Pin MSOP
MCP6282	2	5 MHz	445	3	2.2 to 5.5	-40 to +125	Rail-to-Rail Input/Output	8-Pin PDIP, 8-Pin SOIC, 8-Pin MSOP
MCP6283	1	5 MHz	445	3	2.2 to 5.5	-40 to +125	Rail-to-Rail Input/Output, Chip Select	8-Pin PDIP, 8-Pin SOIC, 8-Pin MSOP
MCP6284	4	5 MHz	445	3	2.2 to 5.5	-40 to +125	Rail-to-Rail Input/Output	14-Pin PDIP, 14-Pin SOIC, 14-Pin TSSOP
MCP6285	2	5 MHz	400	3	2.2 to 5.5	-40 to +125	Rail-to-Rail Input/Output, Dual connected, Chip Select	8-Pin PDIP, 8-Pin SOIC, 8-Pin MSOP
MCP6291	1	10 MHz	1000	3	2.4 to 5.5	-40 to +125	Rail-to-Rail Input/Output	8-Pin PDIP, 8-Pin SOIC, 8-Pin MSOP
MCP6292	2	10 MHz	1000	3	2.4 to 5.5	-40 to +125	Rail-to-Rail Input/Output	8-Pin PDIP, 8-Pin SOIC, 8-Pin MSOP
MCP6293	1	10 MHz	1000	3	2.4 to 5.5	-40 to +125	Rail-to-Rail Input/Output, Chip Select	8-Pin PDIP, 8-Pin SOIC, 8-Pin MSOP
MCP6294	4	10 MHz	1000	3	2.4 to 5.5	-40 to +125	Rail-to-Rail Input/Output	14-Pin PDIP, 14-Pin SOIC, 14-Pin TSSOP
MCP6295	2	10 MHz	1100	3	2.4 to 5.5	-40 to +125	Rail-to-Rail Input/Output, Dual connected, Chip Select	8-Pin PDIP, 8-Pin SOIC, 8-Pin MSOP
MCP6021	1	10 MHz	1000	0.5	2.5 to 5.5	-40 to +125	Rail-to-Rail Input/Output, 1/2 VCC VREF	8-Pin PDIP, 8-Pin SOIC, 8-Pin TSSOP
MCP6022	2	10 MHz	1000	0.5	2.5 to 5.5	-40 to +125	Rail-to-Rail Input/Output	8-Pin PDIP, 8-Pin SOIC, 8-Pin TSSOP
MCP6023	1	10 MHz	1000	0.5	2.5 to 5.5	-40 to +125	Rail-to-Rail Input/Output, Chip Select	8-Pin PDIP, 8-Pin SOIC, 8-Pin TSSOP
MCP6024	4	10 MHz	1000	0.5	2.5 to 5.5	-40 to +125	Rail-to-Rail Input/Output	14-Pin PDIP, 14-Pin SOIC, 14-Pin TSSOP

NOTE: All TC10XX Op Amps have rail-to-rail inputs and outputs.

LINEAR – High Precision Operational Amplifiers

Part #	# per Package	GBWP	Iq Max (mA)	Typical Vos (µV)	Vos Drift Max (µV/°C)	Operating Voltage (V)	Temp. Range (°C)	Features	Packages
Chopper Stabilized									
TC7650	1	2.0 MHz	3.5	5	0.05	4.5 to 16	0 to 70	Single and Split Supply	8-Pin PDIP, 14-Pin PDIP
TC7652	1	0.4 MHz	3	5	0.05	5 to 16	0 to 70	Single and Split Supply, Low Noise	8-Pin PDIP, 14-Pin PDIP
Auto-Zero									
TC913	2	1.5 MHz	1.1	15	0.15	6.5 to 16	0 to 70	Single and Split Supply	8-Pin PDIP

Analog/Interface Family Products

LINEAR – Programmable Gain Amplifiers (PGA)

Part #	Channels	-3dB BW (MHz)	Iq Typ.	Vos (μ V)	Operating Voltage (V)	Temp. Range ($^{\circ}$ C)	Features	Packages
MCP6S21	1	2 to 12	1.1 mA	275	2.5 to 5.5	-40 to +85	SPI, 8 Gain Steps, Software Shutdown	8-Pin PDIP, 8-Pin SOIC, 8-Pin MSOP
MCP6S22	2	2 to 12	1.1 mA	275	2.5 to 5.5	-40 to +85	SPI, 8 Gain Steps, Software Shutdown	8-Pin PDIP, 8-Pin SOIC, 8-Pin MSOP
MCP6S26	6	2 to 12	1.1 mA	275	2.5 to 5.5	-40 to +85	SPI, 8 Gain Steps, Software Shutdown	14-Pin PDIP, 14-Pin SOIC, 14-Pin TSSOP
MCP6S28	8	2 to 12	1.1 mA	275	2.5 to 5.5	-40 to +85	SPI, 8 Gain Steps, Software Shutdown	16-Pin PDIP, 16-Pin SOIC

LINEAR – Integrated Devices

Part #	# of Op Amps per Package	# of Comparators per Package	Iq Typical (μ A)	VREF (V)	Operating Voltage (V)	Temp. Range ($^{\circ}$ C)	Features	Packages
TC1026C	1	1	12	1.2	1.8 to 5.5	-40 to +85	On-board VREF	8-Pin PDIP, 8-Pin MSOP, 8-Pin SOIC
TC1043C	2	2	16	1.2	1.8 to 5.5	-40 to +85	On-board VREF, Shutdown pin	16-Pin QSOP

LINEAR – Comparators

Part #	# per Package	VREF (V)	Typical Propagation Delay (μ s)	Iq Typical (μ A)	Vos Max (mV)	Operating Voltage (V)	Temp. Range ($^{\circ}$ C)	Features	Packages
TC1025	2	—	4	8	5	1.8 to 5.5	-40 to +85		8-Pin PDIP, 8-Pin MSOP, 8-Pin SOIC
TC1027	4	1.2	4	18	5	1.8 to 5.5	-40 to +85	On-board VREF	16-Pin PDIP, 16-Pin QSOP, 16-Pin SOIC
TC1028	2	1.2	4	10	5	1.8 to 5.5	-40 to +85	Shutdown pins, On-board VREF	8-Pin MSOP
TC1031	1	1.2	4	6	5	1.8 to 5.5	-40 to +85	On-board VREF, Programmable hysteresis, Shutdown pin	8-Pin MSOP
TC1037	1	—	4	4	5	1.8 to 5.5	-40 to +85		5-Pin SOT-23A
TC1038	1	—	4	4	5	1.8 to 5.5	-40 to +85	Shutdown pin	6-Pin SOT-23A
TC1039	1	1.2	4	6	5	1.8 to 5.5	-40 to +85	On-board VREF	6-Pin SOT-23A
TC1040	2	1.2	4	10	5	1.8 to 5.5	-40 to +85	On-board VREF, Shutdown pin	8-Pin MSOP
TC1041	2	1.2	4	10	5	1.8 to 5.5	-40 to +85	On-board VREF, Programmable hysteresis	8-Pin MSOP, 8-Pin SOIC
MCP6541	1	—	4	1	5	1.6 to 5.5	-40 to +85	Push-Pull, Rail-to-Rail Input/Output	5-Pin SOT-23, 8-Pin PDIP, 8-Pin SOIC, 8-Pin MSOP
MCP6542	2	—	4	1	5	1.6 to 5.5	-40 to +85	Push-Pull, Rail-to-Rail Input/Output	8-Pin PDIP, 8-Pin SOIC, 8-Pin MSOP
MCP6543	1	—	4	1	5	1.6 to 5.5	-40 to +85	Push-Pull, Rail-to-Rail Input/Output, Chip Select	8-Pin PDIP, 8-Pin SOIC, 8-Pin MSOP
MCP6544	4	—	4	1	5	1.6 to 5.5	-40 to +85	Push-Pull, Rail-to-Rail Input/Output	14-Pin PDIP, 14-Pin SOIC, 14-Pin TSSOP
MCP6546	1	—	4	1	5	1.6 to 5.5	-40 to +85	Open-drain, 9V, Rail-to-Rail Input/Output	5-Pin SOT-23, 8-Pin PDIP, 8-Pin SOIC, 8-Pin MSOP
MCP6547	2	—	4	1	5	1.6 to 5.5	-40 to +85	Open-drain, 9V, Rail-to-Rail Input/Output	8-Pin PDIP, 8-Pin SOIC, 8-Pin MSOP
MCP6548	1	—	4	1	5	1.6 to 5.5	-40 to +85	Open-drain, 9V, Rail-to-Rail Input/Output, Chip Select	8-Pin PDIP, 8-Pin SOIC, 8-Pin MSOP
MCP6549	4	—	4	1	5	1.6 to 5.5	-40 to +85	Open -drain, 9V, Rail-to-Rail Input/Output	14-Pin PDIP, 14-Pin SOIC, 14-Pin TSSOP

NOTE: All Comparators have rail-to-rail inputs and outputs.

MIXED SIGNAL – Successive Approximation Register (SAR) A/D Converters

Part #	Resolution (bits)	Maximum Sampling Rate (ksamples/sec)	# of Input Channels	Input Type	Interface	Input Voltage Range (V)	Max. Supply Current (μ A)	Max. INL	Temp. Range ($^{\circ}$ C)	Packages
MCP3021	10	22	1	Single-ended	I ² C	2.7 to 5.5	250	+1 LSB	-40 to +125	5-Pin SOT-23A
MCP3001	10	200	1	Single-ended	SPI	2.7 to 5.5	500	\pm 1 LSB	-40 to +85	8-Pin PDIP, 8-Pin SOIC, 8-Pin TSSOP
MCP3002	10	200	2	Single-ended	SPI	2.7 to 5.5	650	\pm 1 LSB	-40 to +85	8-Pin PDIP, 8-Pin SOIC, 8-Pin TSSOP
MCP3004	10	200	4	Single-ended	SPI	2.7 to 5.5	550	\pm 1 LSB	-40 to +85	14-Pin PDIP, 14-Pin SOIC, 14-Pin TSSOP
MCP3008	10	200	8	Single-ended	SPI	2.7 to 5.5	550	\pm 1 LSB	-40 to +85	16-Pin PDIP, 16-Pin SOIC
MCP3221	12	22	1	Single-ended	I ² C	2.7 to 5.5	250	\pm 2 LSB	-40 to +125	5-Pin SOT-23A
MCP3201	12	100	1	Single-ended	SPI	2.7 to 5.5	400	\pm 1 LSB	-40 to +85	8-Pin PDIP, 8-Pin SOIC, 8-Pin TSSOP
MCP3202	12	100	2	Single-ended	SPI	2.7 to 5.5	550	\pm 1 LSB	-40 to +85	8-Pin PDIP, 8-Pin SOIC, 8-Pin TSSOP
MCP3204	12	100	4	Single-ended	SPI	2.7 to 5.5	400	\pm 1 LSB	-40 to +85	14-Pin PDIP, 14-Pin SOIC, 14-Pin TSSOP
MCP3208	12	100	8	Single-ended	SPI	2.7 to 5.5	400	\pm 1 LSB	-40 to +85	16-Pin PDIP, 16-Pin SOIC
MCP3301	13	100	1	Differential	SPI	2.7 to 5.5	450	\pm 1 LSB	-40 to +85	8-Pin PDIP, 8-Pin SOIC, 8-Pin MSOP
MCP3302	13	100	2	Differential	SPI	2.7 to 5.5	450	\pm 1 LSB	-40 to +85	14-Pin PDIP, 14-Pin SOIC, 14-Pin TSSOP
MCP3304	13	100	4	Differential	SPI	2.7 to 5.5	450	\pm 1 LSB	-40 to +85	16-Pin PDIP, 16-Pin SOIC

MIXED SIGNAL – Sigma-Delta A/D Converters

Part #	Resolution (bits)	Maximum Sampling Rate (samples/sec)	# of Input Channels	Interface	Supply Voltage Range (V)	Typical Supply Current (μ A)	Typical INL (%FSR)	Temp. Range ($^{\circ}$ C)	Features	Packages
TC3400 ⁽¹⁾	10 to 16	>400	1 Diff	2-Wire	1.8 to 5.5	260	0.0038	0 to +85		8-Pin PDIP, 8-Pin SOIC
TC3401 ⁽¹⁾	10 to 16	>400	2 Diff	2-Wire	1.8 to 5.5	300	0.0038	0 to +85	Enable mode, Reset monitor, Power-fail monitor	16-Pin PDIP, 16-Pin QSOP
TC3402 ⁽¹⁾	10 to 16	>400	4 Diff	2-Wire	1.8 to 5.5	250	0.0038	0 to +85		16-Pin PDIP, 16-Pin QSOP
TC3405 ⁽¹⁾	10 to 16	>400	3 Single-ended, 1 Diff	2-Wire	1.8 to 5.5	250	0.0038	0 to +85	Enable mode, Reset monitor	16-Pin PDIP, 16-Pin QSOP

NOTE 1: All TC340X are not recommended for new designs.

MIXED SIGNAL – Dual Slope A/D Converters

Part #	Supply Voltage (V)	Input Voltage Range (V)	Resolution	Sampling Rate (Conv/s)	Input Channels	Data Interface	Temp. Range ($^{\circ}$ C)	Features	Packages
TC500	\pm 4.5 to \pm 7.5	VSS + 1.5V to VDD – 1.5V	Up to 16 bits	4 to 10	1	3-Wire	0 to +70	Differential input range, Programmable resolution/conversion time	16-Pin PDIP, 16-Pin SOIC, 16-Pin CerDIP
TC500A	\pm 4.5 to \pm 7.5	VSS + 1.5V to VDD – 1.5V	Up to 17 bits	4 to 10	1	3-Wire	0 to +70	Differential input range, Programmable resolution/conversion time	16-Pin PDIP, 16-Pin SOIC, 16-Pin CerDIP
TC510	+4.5 to +5.5	VSS + 1.5V to VDD – 1.5V	Up to 17 bits	4 to 10	1	3-Wire	0 to +70	Differential input range, Programmable resolution/conversion time, Charge pump (-V) output pin	24-Pin PDIP, 24-Pin SOIC

Analog/Interface Family Products

MIXED SIGNAL – Dual Slope A/D Converters

Part #	Supply Voltage (V)	Input Voltage Range (V)	Resolution	Sampling Rate (Conv/s)	Input Channels	Data Interface	Temp. Range (°C)	Features	Packages
TC514	+4.5 to +5.5	V _{SS} + 1.5V to V _{DD} – 1.5V	Up to 17 bits	4 to 10	4	3-Wire	0 to +70	Differential input range, Programmable resolution/conversion time, Charge pump (-V) output pin	28-Pin PDIP, 28-Pin SOIC
TC520A	+4.5 to +5.5	—	—	—	—	Serial port	0 to +70	Optional serial interface adapter for TC500/500A/510/514	14-Pin PDIP, 16-Pin SOIC
TC530	+4.5 to +5.5	V _{SS} + 1.5V to V _{DD} – 1.5V	Up to 17 bits	3 to 10	1	Serial port	0 to +70	Differential input range, Programmable resolution/conversion time, Charge pump (-V) output pin	28-Pin PDIP, 28-Pin SOIC
TC534	+4.5 to +5.5	V _{SS} + 1.5V to V _{DD} – 1.5V	Up to 17 bits	3 to 10	4	Serial port	0 to +70	Differential input range, Programmable resolution/conversion time, Charge pump (-V) output pin	40-Pin PDIP, 44-Pin MQFP
TC7109	±4.5 to ±5.5	V _{SS} + 1.5V to V _{DD} – 1.0V	12 bits plus sign bit	2 to 10	1	Parallel or Serial port	-25 to +85	Differential input range	40-Pin PDIP, 40-Pin CerDip, 44-Pin PLCC, 44-Pin MQFP
TC7109A	±4.5 to ±5.5	V _{SS} + 1.5V to V _{DD} – 1.0V	12 bits plus sign bit	2 to 10	1	Parallel or Serial port	-25 to +85	Differential input range	40-Pin PDIP, 40-Pin CerDip, 44-Pin PLCC, 44-Pin MQFP

MIXED SIGNAL – Binary and BCD A/D Converters

Part #	Description	Supply Voltage (V)	Input Voltage Range (V)	Resolution (Digits)	Resolution (Counts)	Max Power (mW)	Data Interface	Temp. Range (°C)	Features	Packages
TC835	BCD A/D	±5	V _{SS} + 1.0V to V _{DD} – 0.5V	4½	±20,000	30	MUXed BCD	0 to +70	Upgrade to TC7135	64-Pin MQFP, 44-Pin MQFP, 28-Pin PDIP
TC850	Binary A/D	±5	V _{SS} + 1.5V to V _{DD} – 1.5V	15-bit	±32,768	35	8-bit parallel	-25 to +70	Highest conversion speed (40 conv/sec)	44-Pin PLCC, 40-Pin PDIP, 40-Pin CerDIP
TC7135	BCD A/D	±5	V _{SS} + 1.0V to V _{DD} – 1.0V	4½	±20,000	30	MUXed BCD	0 to +70	For DMM, DPM, Data loggers	28-Pin PLCC, 28-Pin PDIP, 64-Pin MQFP
TC14433	BCD A/D	±4.5 to ±8	±199.9 mV to 1.999V	3½	±2,000	20	MUXed BCD	-40 to +85	For DMM, DPM, Data loggers	24-Pin SOIC, 24-Pin PDIP, 28-Pin PLCC, 24-Pin CerDIP
TC14433A	BCD A/D	±4.5 to ±8	±199.9 mV to 1.999V	3½	±2,000	20	MUXed BCD	-40 to +85	For DMM, DPM, Data loggers	24-Pin PDIP, 28-Pin PLCC, 24-Pin CerDIP

MIXED SIGNAL – Display A/D Converters

Part #	Display Type	Supply Voltage (V)	Resolution (Digits)	Resolution (Counts)	Power (mW)	Temp. Range (°C)	Features	Packages
TC820	LCD	9	3¾	±4,000	10	0 to +70	DMM plus frequency counter and logic probe	40-Pin PDIP, 44-Pin PLCC, 44-Pin MQFP
TC7106	LCD	9	3½	±2,000	10	-25 to +85	For DMM, DPM, Data logger applications	40-Pin PDIP, 44-Pin PLCC, 44-Pin MQFP, 40-Pin CerDIP
TC7106A	LCD	9	3½	±2,000	10	-25 to +85	For DMM, DPM, Data logger applications	40-Pin PDIP, 44-Pin PLCC, 44-Pin MQFP, 40-Pin CerDIP
TC7107	LED	±5	3½	±2,000	10	-25 to +85	For DMM, DPM, Data logger applications	40-Pin PDIP, 44-Pin PLCC, 44-Pin MQFP, 40-Pin CerDIP
TC7107A	LED	±5	3½	±2,000	10	-25 to +85	For DMM, DPM, Data logger applications	40-Pin PDIP, 44-Pin PLCC, 44-Pin MQFP, 40-Pin CerDIP
TC7116	LCD	9	3½	±2,000	10	-25 to +85	Hold function	40-Pin PDIP, 44-Pin PLCC, 44-Pin MQFP, 40-Pin CerDIP
TC7116A	LCD	9	3½	±2,000	10	-25 to +85	Hold function	40-Pin PDIP, 44-Pin PLCC, 44-Pin MQFP, 40-Pin CerDIP

NOTE 1: This product is on "End-of-Life" status.

MIXED SIGNAL – Display A/D Converters

Part #	Display Type	Supply Voltage (V)	Resolution (Digits)	Resolution (Counts)	Power (mW)	Temp. Range (°C)	Features	Packages
TC7117	LED	±5	3½	±2,000	10	-25 to +85	Hold function	40-Pin PDIP, 44-Pin PLCC, 44-Pin MQFP, 40-Pin CerDIP
TC7117A	LED	±5	3½	±2,000	10	-25 to +85	Hold function	40-Pin PDIP, 44-Pin PLCC, 44-Pin MQFP, 40-Pin CerDIP
TC7126	LCD	9	3½	±2,000	0.5	-25 to +85	Low-power TC7106	40-Pin PDIP, 44-Pin PLCC, 44-Pin MQFP, 40-Pin CerDIP
TC7126A	LCD	9	3½	±2,000	0.5	-25 to +85	Low-power TC7106	40-Pin PDIP, 44-Pin PLCC, 44-Pin MQFP, 40-Pin CerDIP
TC7129	LCD	9	4½	±20,000	4.5	0 to +70	Lowest noise ±3 mV sensitivity	40-Pin PDIP, 44-Pin PLCC, 44-Pin MQFP
TC7136	LCD	9	3½	±2,000	0.5	0 to +70	Low-power/noise TC7106	40-Pin PDIP, 44-Pin PLCC, 44-Pin MQFP
TC7136A	LCD	9	3½	±2,000	0.5	0 to +70	Low-power/noise TC7106	40-Pin PDIP, 44-Pin PLCC, 44-Pin MQFP

NOTE 1: This product is on “End-of-Life” status.

MIXED SIGNAL – Digital Potentiometers

Part #	Number of Taps	Number per Package	Interface	Resistance (ohms)	INL (max)	DNL (max)	Temp. Range (°C)	Packages
MCP41010	256	1	SPI	10K	±1 LSB	±1 LSB	-40 to +85	8-Pin PDIP, 8-Pin SOIC
MCP41050	256	1	SPI	50K	±1 LSB	±1 LSB	-40 to +85	8-Pin PDIP, 8-Pin SOIC
MCP41100	256	1	SPI	100K	±1 LSB	±1 LSB	-40 to +85	8-Pin PDIP, 8-Pin SOIC
MCP42010	256	2	SPI	10K	±1 LSB	±1 LSB	-40 to +85	14-Pin PDIP, 14-Pin SOIC, 14-Pin TSSOP
MCP42050	256	2	SPI	50K	±1 LSB	±1 LSB	-40 to +85	14-Pin PDIP, 14-Pin SOIC, 14-Pin TSSOP
MCP42100	256	2	SPI	100K	±1 LSB	±1 LSB	-40 to +85	14-Pin PDIP, 14-Pin SOIC, 14-Pin TSSOP

MIXED SIGNAL – Frequency-to-Voltage/Voltage-to-Frequency Converters

Part #	Frequency Range (kHz)	Full Scale (ppm FS/°C)	Non-linearity (%FS)	Temp. Range (°C)	Packages
TC9400	100	±40	±0.05	-40 to +85	14-Pin PDIP, 14-Pin SOIC
TC9401	100	±40	±0.02	-40 to +85	14-Pin PDIP, 14-Pin SOIC
TC9402	100	±100	±0.25	-40 to +85	14-Pin PDIP, 14-Pin SOIC

Analog/Interface Family Products

MIXED SIGNAL – System D/A Converters

Part #	Resolution (Bits)	DACs per Package	Interface	VREF	Output Settling Time (μ s)	DNL (LSB)	Typical Standby Current (μ A)	Typical Operating Current (μ A)	Temp. Range ($^{\circ}$ C)	Packages
TC1320	8	1	SMBus	Ext	10	± 0.8	0.1	350	-40 to +85	8-Pin MSOP, 8-Pin SOIC
TC1321	10	1	SMBus	Ext	10	± 2	0.1	350	-40 to +85	8-Pin MSOP, 8-Pin SOIC
MCP4921	12	1	SPI™	Ext.	8	1	1	450	-40 to +125	8-Pin PDIP, 8-Pin SOIC, 8-Pin MSOP
MCP4922	12	2	SPI	Ext	8	1	1	450	-40 to +125	14-Pin PDIP, 14-Pin SOIC, 14-Pin TSSOP

NOTE: The analog output is voltage.

INTERFACE – Controller Area Network (CAN) Products

Part #	Operating Voltage (V)	Temperature Range ($^{\circ}$ C)	Tx Buffers	Rx Buffers	Filters	Masks	Interrupt Output	Unique Features	Packages
MCP2510 ⁽¹⁾	2.7 to 5.5	-40 to +125	3	2	6	2	Yes	CAN 2.0B Active controller with SPI interface to MCU, 3 transmit buffers, 2 receive buffers, HW and SW message triggers	18-Pin PDIP, 18-Pin SOIC, 20-Pin TSSOP
MCP2515	2.7 to 5.5	-40 to +125	3	2	6	2	Yes	MCP2510 pin compatible upgrade with enhanced features including higher throughput and data byte filtering	18-Pin PDIP, 18-Pin SOIC, 20-Pin TSSOP
MCP25020	2.7 to 5.5	-40 to +125	3	2	2	1	N/A	CAN 2.0B Active I/O Expander, Configurable I/O, 2 PWM outputs	14-Pin PDIP, 14-Pin SOIC
MCP25025	2.7 to 5.5	-40 to +85	3	2	2	1	N/A	CAN 2.0B Active I/O Expander, Configurable I/O, 2 PWM outputs, One-wire CAN option	14-Pin PDIP, 14-Pin SOIC
MCP25050	2.7 to 5.5	-40 to +125	3	2	2	1	N/A	Mixed-Signal CAN 2.0B Active I/O Expander, Configurable I/O, 4 10-bit ADCs, 2 PWM outputs	14-Pin PDIP, 14-Pin SOIC
MCP25055	2.7 to 5.5	-40 to +85	3	2	2	1	N/A	Mixed-Signal CAN 2.0B Active I/O Expander, Configurable I/O, 4 10-bit ADCs, 2 PWM outputs, One-wire CAN option	14-Pin PDIP, 14-Pin SOIC
MCP2551	4.5 to 5.5	-40 to +125	n/a	n/a	n/a	n/a	N/A	High-Speed CAN Transceiver (1 Mbps max. CAN bus speed), ISO11898 compatible, Industry standard pinout	8-Pin PDIP, 8-Pin SOIC

NOTE 1: Not recommended for new designs.

INTERFACE – Infrared Products

Part #	Operating Voltage (V)	Operating Temperature Range (°C)	Max. Baud Rate (Kbaud)	Unique Features	Packages
MCP2120	2.5 to 5.5	-40 to +85	325	UART to IR encoder/decoder with both hardware and software baud rate selection	14-Pin PDIP, 14-Pin SOIC
MCP2122	1.8 to 5.5	-40 to +85	16x less than clock input	UART to IR encoder/decoder	8-Pin PDIP, 8-Pin SOIC
MCP2140	2.7 to 5.5	-40 to +85	9.6	IrDA® protocol handler plus bit encoder/decoder, Fixed baud rate, Low-Cost	18-Pin PDIP, 18-Pin SOIC, 20-Pin SSOP
MCP2150	3.0 to 5.5	-40 to +85	115.2	IrDA® Standard protocol handler plus bit encoder/decoder on one chip for DTE applications, Programmable ID	18-Pin PDIP, 18-Pin SOIC, 20-Pin SSOP
MCP2155	3.0 to 5.5	-40 to +85	115.2	IrDA® Standard protocol handler plus bit encoder/decoder on one chip for DCE applications, Programmable ID	18-Pin PDIP, 18-Pin SOIC, 20-Pin SSOP

NOTE: IrDA® is a registered trademark of Infrared Data Association.

INTERFACE – LIN Transceiver Products

Part #	Description	Vreg Output Voltage (V)	Operating Temperature Range (°C)	Vreg Output Current (mA)	Vcc Range (V)	Max Baud Rate	LIN Specification Supported	Packages
MCP201	LIN Transceiver with integrated VREG	4.75 to 5.25	-40 to +125	50 ⁽¹⁾	6.0 to 18 ⁽²⁾	20 Kbaud	Revision 1.2	8-pin PDIP, 8-pin SOIC

NOTE 1: Output current can be increased with external pass transistor.
 2: Can withstand 40V load dump.

INTERFACE – Serial Peripherals

Part #	Description	Operating Voltage (V)	Operating Temperature Range (°C)	Bus Type	Max. Bus Frequency (kHz)	Features	Packages
MCP23008	8-bit I/O Port Expander	1.8 to 5.5	-40 to +85	I ² C™	3400	3 HW address pins, HW interrupt, 25 mA source/sink capability per I/O	18-Pin PDIP, 18-Pin SOIC, 20-Pin SSOP
MCP23S08	8-bit I/O Port Expander	1.8 to 5.5	-40 to +85	SPI™	10000	2 HW address pins, HW interrupt, 25 mA source/sink capability per I/O	18-Pin PDIP, 18-Pin SOIC, 20-Pin SSOP
MCP23016	16-bit I/O Port Expander	2.0 to 5.5	-40 to +85	I ² C™	400	3 H/W address inputs, HW interrupt, 25 mA source/sink capability per I/O	28-Pin PDIP, 28-Pin SOIC, 28-Pin SSOP, 28-Pin 6x6 QFN

SERIAL ELECTRICALLY ERASABLE PROMS (EEPROM)

Product	E/W Cycles	Density (Organization)	Write Speed	Max. Clock Freq.	Operating Voltage (V)	Temps	Max. Standby Current	Unique Features	Packages ^(Note)
Microwire Compatible Serial EEPROM Family – Automatic ERAL before WRAL, self-timed erase and write cycle, power on/off data protection circuitry, sequential read function and industry standard 3-wire serial I/O									
93C46A	1M	1 Kbits (x8)	2 ms	2 MHz	4.5 to 5.5	C, I, E	5 µA	93Cx6A and 93Cx6B devices have no ORG pin. 93Cx6A parts have x8 organization; 93Cx6B parts are x16. Devices in this family include POR (VDD detect) feature. Use 93C76C or 93C86C devices for P, SN, ST or MS packages. Use 93C76C or 93C86C devices for P, SN, ST or MS packages. Use 93C76C or 93C86C devices for P, SN, ST or MS packages. Use 93C76C or 93C86C devices for P, SN, ST or MS packages.	P, SN, ST, MS, OT, X/SN
93C46B	1M	1 Kbits (x16)	2 ms	2 MHz	4.5 to 5.5	C, I, E	5 µA		P, SN, ST, MS, OT, X/SN
93C56A	1M	2 Kbits (x8)	2 ms	2 MHz	4.5 to 5.5	I, E	5 µA		P, SN, ST, MS, OT
93C56B	1M	2 Kbits (x16)	2 ms	2 MHz	4.5 to 5.5	I, E	5 µA		P, SN, ST, MS, OT
93C66A	1M	4 Kbits (x8)	2 ms	2 MHz	4.5 to 5.5	I, E	5 µA		P, SN, ST, MS, OT
93C66B	1M	4 Kbits (x16)	2 ms	2 MHz	4.5 to 5.5	I, E	5 µA		P, SN, ST, MS, OT
93C76A	1M	8 Kbits (x8)	2 ms	3 MHz	4.5 to 5.5	I, E	5 µA		OT
93C76B	1M	8 Kbits (x16)	2 ms	3 MHz	4.5 to 5.5	I, E	5 µA		OT
93C86A	1M	16 Kbits (x8)	2 ms	3 MHz	4.5 to 5.5	I, E	5 µA		OT
93C86B	1M	16 Kbits (x16)	2 ms	3 MHz	4.5 to 5.5	I, E	5 µA		OT
93LC46A	1M	1 Kbits (x8)	6 ms	2 MHz	2.5 to 5.5	C, I, E	5 µA	93LCx6A and 93LCx6B devices have no ORG pin. 93LCx6A parts have x8 organization; 93LCx6B parts are x16. Use 93LC76C or 93LC86C devices for P, SN, ST or MS packages. Use 93LC76C or 93LC86C devices for P, SN, ST or MS packages. Use 93LC76C or 93LC86C devices for P, SN, ST or MS packages. Use 93LC76C or 93LC86C devices for P, SN, ST or MS packages.	P, SN, ST, MS, OT, X/SN
93LC46B	1M	1 Kbits (x16)	6 ms	2 MHz	2.5 to 5.5	C, I, E	5 µA		P, SN, ST, MS, OT, X/SN
93LC56A	1M	2 Kbits (x8)	6 ms	2 MHz	2.5 to 5.5	C, I, E	5 µA		P, SN, ST, MS, OT, X/SN
93LC56B	1M	2 Kbits (x16)	6 ms	2 MHz	2.5 to 5.5	C, I, E	5 µA		P, SN, ST, MS, OT, X/SN
93LC66A	1M	4 Kbits (x8)	6 ms	2 MHz	2.5 to 5.5	C, I, E	5 µA		P, SN, ST, MS, OT, X/SN
93LC66B	1M	4 Kbits (x16)	6 ms	2 MHz	2.5 to 5.5	C, I, E	5 µA		P, SN, ST, MS, OT, X/SN
93LC76A	1M	8 Kbits (x8)	6 ms	3 MHz	2.5 to 5.5	I, E	5 µA		OT
93LC76B	1M	8 Kbits (x16)	6 ms	3 MHz	2.5 to 5.5	I, E	5 µA		OT
93LC86A	1M	16 Kbits (x8)	6 ms	3 MHz	2.5 to 5.5	I, E	5 µA		OT
93LC86B	1M	16 Kbits (x16)	6 ms	3 MHz	2.5 to 5.5	I, E	5 µA		OT
93AA46A	1M	1 Kbits (x8)	6 ms	2 MHz	1.8 to 5.5	I	5 µA	93AAx6A and 93LCx6B devices have no ORG pin. 93AAx6A parts have x8 organization; 93Cx6B parts are x16. Use 93AA76C or 93AA86C devices for P, SN, ST or MS packages. Use 93AA76C or 93AA86C devices for P, SN, ST or MS packages. Use 93AA76C or 93AA86C devices for P, SN, ST or MS packages. Use 93AA76C or 93AA86C devices for P, SN, ST or MS packages.	P, SN, ST, MS, OT
93AA46B	1M	1 Kbits (x16)	6 ms	2 MHz	1.8 to 5.5	I	5 µA		P, SN, ST, MS, OT
93AA56A	1M	2 Kbits (x8)	6 ms	2 MHz	1.8 to 5.5	I	5 µA		P, SN, ST, MS, OT
93AA56B	1M	2 Kbits (x16)	6 ms	2 MHz	1.8 to 5.5	I	5 µA		P, SN, ST, MS, OT
93AA66A	1M	4 Kbits (x8)	6 ms	2 MHz	1.8 to 5.5	I	5 µA		P, SN, ST, MS, OT
93AA66B	1M	4 Kbits (x16)	6 ms	2 MHz	1.8 to 5.5	I	5 µA		P, SN, ST, MS, OT
93AA76A	1M	8 Kbits (x8)	6 ms	3 MHz	1.8 to 5.5	I	5 µA		OT
93AA76B	1M	8 Kbits (x16)	6 ms	3 MHz	1.8 to 5.5	I	5 µA		OT
93AA86A	1M	16 Kbits (x8)	6 ms	3 MHz	1.8 to 5.5	I	5 µA		OT
93AA86B	1M	16 Kbits (x16)	6 ms	3 MHz	1.8 to 5.5	I	5 µA		OT
93C46C	1M	1 Kbits (x8 or x16)	2 ms	3 MHz	4.5 to 5.5	I, E	5 µA	93Cx6C devices can be used in either x8 or x16 organization via the ORG pin. Devices in this family include POR (VDD detect) feature.	P, SN, ST, MS
93C56C	1M	2 Kbits (x8 or x16)	2 ms	3 MHz	4.5 to 5.5	I, E	5 µA		P, SN, ST, MS
93C66C	1M	4 Kbits (x8 or x16)	2 ms	3 MHz	4.5 to 5.5	I, E	5 µA		P, SN, ST, MS
93C76C	1M	8 Kbits (x8 or x16)	2 ms	3 MHz	4.5 to 5.5	I, E	5 µA		P, SN, ST, MS
93C86C	1M	16 Kbits (x8 or x16)	2 ms	3 MHz	4.5 to 5.5	I, E	5 µA		P, SN, ST, MS
93LC46C	1M	1 Kbits (x8 or x16)	6 ms	3 MHz	2.5 to 5.5	I, E	5 µA	93LCx6C devices can be used in either x8 or x16 organization via the ORG pin.	P, SN, ST, MS, X/SN
93LC56C	1M	2 Kbits (x8 or x16)	6 ms	3 MHz	2.5 to 5.5	I, E	5 µA		P, SN, ST, MS, X/SN
93LC66C	1M	4 Kbits (x8 or x16)	6 ms	3 MHz	2.5 to 5.5	I, E	5 µA		P, SN, ST, MS, X/SN
93LC76C	1M	8 Kbits (x8 or x16)	6 ms	3 MHz	2.5 to 5.5	I, E	5 µA		P, SN, ST, MS
93LC86C	1M	16 Kbits (x8 or x16)	6 ms	3 MHz	2.5 to 5.5	I, E	5 µA		P, SN, ST, MS
93AA46C	1M	1 Kbits (x8 or x16)	6 ms	3 MHz	1.8 to 5.5	I	5 µA	93AAx6C devices can be used in either x8 or x16 organization via the ORG pin.	P, SN, ST, MS, X/SN
93AA56C	1M	2 Kbits (x8 or x16)	6 ms	3 MHz	1.8 to 5.5	I	5 µA		P, SN, ST, MS, X/SN
93AA66C	1M	4 Kbits (x8 or x16)	6 ms	3 MHz	1.8 to 5.5	I	5 µA		P, SN, ST, MS, X/SN
93AA76C	1M	8 Kbits (x8 or x16)	6 ms	3 MHz	1.8 to 5.5	I	5 µA		P, SN, ST, MS
93AA86C	1M	16 Kbits (x8 or x16)	6 ms	3 MHz	1.8 to 5.5	I	5 µA		P, SN, ST, MS

NOTE: All 93-series parts are available with Pb-free packages. Order with "G" suffix. Example: 93LC46BT-I/OTG.
X/SN package code denotes rotated pinouts.

Product	E/W Cycles	Density (Organization)	Write Speed	Max. Clock Frequency	Operating Voltage (V)	Temps	Unique Features	Packages ^(Note)
2-Wire I²C™ Compatible Serial EEPROM Family – Self-timed write cycle and Page Write mode								
24C00	1M	128 bits (x8)	4 ms	400 kHz	4.5 to 5.5	C, I, E	100 kHz operation for voltages from 1.8V to 4.5V.	P, SN, ST, OT
24LC00	1M	128 bits (x8)	4 ms	400 kHz	2.5 to 6.0	C, I		P, SN, ST, OT
24AA00	1M	128 bits (x8)	4 ms	400 kHz	1.8 to 6.0	C, I		P, SN, ST, OT
24C01C	1M	1 Kbits (x8)	1 ms	400 kHz	4.5 to 5.5	C, I, E	The 24C01C and 24C02C are for applications which require fast byte write and/or extended temperature. Three address pins.	P, SN, ST, MS
24C02C	1M	2 Kbits (x8)	1 ms	400 kHz	4.5 to 5.5	C, I, E		P, SN, ST, MS
24LC014	1M	1 Kbit (x8)	10 ms	400 MHz	2.5 to 5.5	I	Three address pins.	P, SN, ST, MS
24AA014	1M	1 Kbit (x8)	10 ms	400 MHz	1.8 to 5.5	I		P, SN, ST, MS
24LC01B	1M	1 Kbits (x8)	5 ms	400 kHz	2.5 to 5.5	I, E	Hardware write protect. Schmitt trigger inputs. 2.5V operation @ extended temperatures. 100 kHz operation @ extended temperatures. B version on 2-wire devices designates that address pins A0, A1, A2 are no-connect.	P, SN, ST, MS, OT
24LC02B	1M	2 Kbits (x8)	5 ms	400 kHz	2.5 to 5.5	I, E		P, SN, ST, MS, OT
24LC04B	1M	4 Kbits (x8)	5 ms	400 kHz	2.5 to 5.5	I, E		P, SN, ST, MS, OT
24LC08B	1M	8 Kbits (x8)	5 ms	400 kHz	2.5 to 5.5	I, E		P, SN, ST, MS, OT
24LC16B	1M	16 Kbits (x8)	5 ms	400 kHz	2.5 to 5.5	I, E		P, SN, ST, MS, OT
24AA01	1M	1 Kbits (x8)	5 ms	400 kHz	1.8 to 5.5	I		Hardware write protect. Schmitt trigger inputs. 100 kHz operation for voltages from 1.8V to 2.5V.
24AA02	1M	2 Kbits (x8)	5 ms	400 kHz	1.8 to 5.5	I	P, SN, ST, MS, OT	
24AA04	1M	4 Kbits (x8)	5 ms	400 kHz	1.8 to 5.5	I	P, SN, ST, MS, OT	
24AA08	1M	8 Kbits (x8)	5 ms	400 kHz	1.8 to 5.5	I	P, SN, ST, MS, OT	
24AA16	1M	16 Kbits (x8)	5 ms	400 kHz	1.8 to 5.5	I	P, SN, ST, MS, OT	
24LC32A	1M	32 Kbits (x8)	5 ms	400 kHz	2.5 to 5.5	I, E	100 kHz operation for voltages from 1.8V to 2.5V.	P, SN, SM, ST, MS
24AA32A	1M	32 Kbits (x8)	5 ms	400 kHz	1.8 to 5.5	I		P, SN, SM, ST, MS
24LC64	1M	64 Kbits (x8)	5 ms	400 kHz	2.5 to 5.5	I, E	32-byte page. 100 kHz operation for voltages from 1.8V to 2.5V.	P, SN, SM, ST, MS
24AA64	1M	64 Kbits (x8)	5 ms	400 kHz	1.8 to 5.5	I		P, SN, SM, ST, MS
24LC65	1 M/10 M	64 Kbits (x8)	5 ms	400 kHz	2.5 to 5.5	C, I	8-byte page, 64-byte input buffer, high-endurance block, write protectable in 4K blocks. Smart Serial™ EEPROM.	P, SM
24AA65	1 M/10 M	64 Kbits (x8)	5 ms	400 kHz	1.8 to 5.5	C		P, SM
24C65	1 M/10 M	64 Kbits (x8)	5 ms	400 kHz	4.5 to 5.5	C, I, E		P, SM
24LC128	1M	128 Kbits (x8)	5 ms	400 kHz	2.5 to 5.5	I, E	64-byte page. 100 kHz operation for voltages from 1.8V to 2.5V.	P, SN, SM, ST, MS, MF
24AA128	1M	128 Kbits (x8)	5 ms	400 kHz	1.8 to 5.5	I		P, SN, SM, ST, MS, MF
24FC128	1M	128 Kbits (x8)	5 ms	1 MHz	2.5 to 5.5	I		P, SN, SM, ST, MS, MF
24LC256	1M	256 Kbits (x8)	5 ms	400 kHz	2.5 to 5.5	I, E	64-byte page. 100 kHz operation for voltages from 1.8V to 2.5V.	P, SM, SN, ST, MS, MF
24AA256	1M	256 Kbits (x8)	5 ms	400 kHz	1.8 to 5.5	I		P, SM, SN, ST, MS, MF
24FC256	1M	256 Kbits (x8)	5 ms	1 MHz	2.5 to 5.5	I		P, SN, SM, ST, MS, MF
24LC512	1M	512 Kbits (x8)	5 ms	400 kHz	2.5 to 5.5	I, E	128-byte page, cascadeable up to 8 devices (4 Mbits). 100 kHz operation for voltages from 1.8 to 2.5V. 400 kHz operation for voltages below 4.5V. (24FC512).	P, MF, ST14, SM
24AA512	1M	512 Kbits (x8)	5 ms	400 kHz	1.8 to 5.5	I		P, MF, ST14, SM
24FC512	1M	512 Kbits (x8)	5 ms	1 MHz	2.5 to 5.5	I		P, MF, ST14, SM
24LC515	1M	512 Kbits (x8)	5 ms	400 kHz	2.5 to 5.5	I	Cascadeable up to 4 devices (2 Mbits). 100 kHz operation for voltages from 1.8V to 2.5V.	P, SM
24AA515	1M	512 Kbits (x8)	5 ms	400 kHz	1.8 to 5.5	I		P, SM
24FC515	1M	512 Kbits (x8)	5 ms	1 MHz	2.5 to 5.5	I		P, SM

NOTE: All 24-series parts in this section are available with Pb-free packages. Order with "G" suffix. Example: 24LC01BT-I/OTG.

Memory Family Products

Product	E/W Cycles	Density (Organization)	Write Speed	Max. Clock Frequency	Operating Voltage (V)	Temps	Unique Features	Packages ^(Note)
ISO Smart Card Family – Self-timed write cycle and Page Write mode. All devices meet ISO7816 pinout requirements.								
24LC01SC	1M	1 Kbits (x8)	5 ms	400 kHz	2.5 to 5.5	C, I		S, W, WF
24LC02SC	1M	2 Kbits (x8)	5 ms	400 kHz	2.5 to 5.5	C, I		S, W, WF
24LC04SC	1M	4 Kbits (x8)	5 ms	400 kHz	2.5 to 5.5	C, I		S, W, WF
24LC08SC	1M	8 Kbits (x8)	5 ms	400 kHz	2.5 to 5.5	C, I		S, W, WF
24LC16SC	1M	16 Kbits (x8)	5 ms	400 kHz	2.5 to 5.5	C, I		S, W, WF
24LC32ASC	1M	32 Kbits (x8)	5 ms	400 kHz	2.5 to 5.5	C, I		S, W, WF
24LC64SC	1M	64 Kbits (x8)	5 ms	400 kHz	2.5 to 5.5	C, I		S, W, WF
24LC128SC	1M	128 Kbits (x8)	5 ms	400 kHz	2.5 to 5.5	C, I		S, W, WF
24LC256SC	1M	256 Kbits (x8)	5 ms	400 kHz	2.5 to 5.5	C, I		S, W, WF
24LC512SC	1M	512 Kbits (x8)	5 ms	400 kHz	2.5 to 5.5	C, I		S, W, WF
24AA01SC	1M	1 Kbits (x8)	5 ms	400 kHz	1.8 to 5.5	C		S, W, WF
24AA02SC	1M	2 Kbits (x8)	5 ms	400 kHz	1.8 to 5.5	C		S, W, WF
24AA04SC	1M	4 Kbits (x8)	5 ms	400 kHz	1.8 to 5.5	C		S, W, WF
24AA08SC	1M	8 Kbits (x8)	5 ms	400 kHz	1.8 to 5.5	C		S, W, WF
24AA16SC	1M	16 Kbits (x8)	5 ms	400 kHz	1.8 to 5.5	C		S, W, WF
24AA32ASC	1M	32 Kbits (x8)	5 ms	400 kHz	1.8 to 5.5	C		S, W, WF
24AA64SC	1M	64 Kbits (x8)	5 ms	400 kHz	1.8 to 5.5	C		S, W, WF
24AA128SC	1M	128 Kbits (x8)	5 ms	400 kHz	1.8 to 5.5	C		S, W, WF
24AA256SC	1M	256 Kbits (x8)	5 ms	400 kHz	1.8 to 5.5	C		S, W, WF
24AA512SC	1M	512 Kbits (x8)	5 ms	400 kHz	1.8 to 5.5	C		S, W, WF

Product	E/W Cycles	Density (Organization)	Page Size	Write Speed	Max. Clock Frequency	Operating Voltage (V)	Temps	Unique Features	Packages ^(Note)
SPI™ Compatible Serial EEPROM Family – Page Write mode, HOLD pin, software enabled block write protection and hardware write-protect pin. Supports SPI™ modes 0, 3.									
25C040	1M	4 Kbits (x8)	16B	5 ms	3 MHz	4.5 to 5.5	I, E		P, SN, X/ST
25LC040	1M	4 Kbits (x8)	16B	5 ms	2 MHz	2.5 to 5.5	I		P, SN, X/ST
25AA040	1M	4 Kbits (x8)	16B	5 ms	1 MHz	1.8 to 5.5	I		P, SN, X/ST
25LC080A	1M	8 Kbits (x8)	16B	5 ms	10 MHz	2.5 to 5.5	I, E		P, SN, ST, MS
25AA080A	1M	8 Kbits (x8)	16B	5 ms	10 MHz	1.8 to 5.5	I		P, SN, ST, MS
25LC080B	1M	8 Kbits (x8)	32B	5 ms	10 MHz	2.5 to 5.5	I, E		P, SN, ST, MS
25AA080B	1M	8 Kbits (x8)	32B	5 ms	10 MHz	1.8 to 5.5	I		P, SN, ST, MS

NOTE: All 25-series products are available in Pb-free packages. Order with "G" suffix. Example: 25LC080AT-I/MSG. X/ST package code denotes rotated pinout.

Product	E/W Cycles	Density (Organization)	Page Size	Write Speed	Max. Clock Frequency	Operating Voltage (V)	Temps	Unique Features	Packages ^(Note)
SPI™ Compatible Serial EEPROM Family – Page Write mode, HOLD pin, software enabled block write protection and hardware write-protect pin. Supports SPI™ modes 0, 3. (continued)									
25LC160A	1M	16 Kbits (x8)	16B	5 ms	10 MHz	2.5 to 5.5	I, E		P, SN, ST, MS
25AA160A	1M	16 Kbits (x8)	16B	5 ms	10 MHz	1.8 to 5.5	I		P, SN, ST, MS
25LC160B	1M	16 Kbits (x8)	32B	5 ms	10 MHz	2.5 to 5.5	I, E		P, SN, ST, MS
25AA160B	1M	16 Kbits (x8)	32B	5 ms	10 MHz	1.8 to 5.5	I		P, SN, ST, MS
25C320	100K	32 Kbits (x8)	32B	5 ms	3 MHz	4.5 to 5.5	I, E		P, SN
25LC320	1M	32 Kbits (x8)	32B	5 ms	2 MHz	2.5 to 5.5	I, E		P, SN, X/ST
25AA320	1M	32 Kbits (x8)	32B	5 ms	1 MHz	1.8 to 5.5	I		P, SN, X/ST
25LC640	1M	64 Kbits (x8)	32B	5 ms	3 MHz	2.5 to 5.5	I, E		P, SN, X/ST
25AA640	1M	64 Kbits (x8)	32B	5 ms	1 MHz	1.8 to 5.5	I		P, SN, X/ST

NOTE: All 25-series products are available in Pb-free packages. Order with "G" suffix. Example: 25LC080AT-I/MSG. X/ST package code denotes rotated pinout.

Product	E/W Cycles	Density (Organization)	Write Speed	Max. Clock Frequency	Operating Voltage (V)	Temps	Unique Features	Packages ^(Note)
Identification Products (Application-Specific Products for Monitors, DRAM Modules, ACR Risers and Other Plug-And-Play Applications)								
24LC21	1M	1 Kbits (x8)	10 ms	400 kHz	2.5 to 5.5	C, I	Completely implements DDC1™/DDC2™ interface for VESA monitor identification. Improved noise filter. Write protection pin. Not recommended for new designs. Use 24LC21A or 24LCS21A.	P, SN
24LCS21	1M	1 Kbits (x8)	10 ms	400 kHz	2.5 to 5.5	C, I	Same as 24LC21 plus software enabled write-protect pin. Not recommended for new designs. Use 24LC21A or 24LCS21A.	P, SN
24LC21A	1M	1 Kbits (x8)	10 ms	400 kHz	2.5 to 5.5	C, I	Same as 24LC21 plus "return to DDC1" feature.	P, SN
24LCS21A	1M	1 Kbits (x8)	10 ms	400 kHz	2.5 to 5.5	C, I	Same as 24LC21A plus software enabled write-protect pin.	P, SN
24LCS22A	1M	2 Kbits (x8)	10 ms	400 kHz	2.5 to 5.5	I	Implements VESA E-EDID 1.3 for flat panels and projectors. Includes "return to DDC1" feature and software - enabled write protect pin.	P, SN
24LC024	1M	2 Kbits (x8)	10 ms	400 kHz	2.5 to 5.5	C, I	Addressable, hardware write protection for DRAM DIMM modules and other applications.	P, SN, ST, MS
24LC025	1M	2 Kbits (x8)	10 ms	400 kHz	2.5 to 5.5	C, I	Addressable. No write-protect.	P, SN, ST, MS
24AA52	1M	2 Kbits (x8)	10 ms	400 kHz	1.8 to 5.5	I	Addressable, hardware write protection and software write protection for lower half of the array. Designed for DRAM DIMM modules.	P, SN, ST, MS
24LCS52	1M	2 Kbits (x8)	10 ms	400 kHz	2.5 to 5.5	I		P, SN, ST, MS

NOTE: Pb-free packages also available. Order with "G" suffix. Example: 24LCS52T-I/STG.

DEVELOPMENT SYSTEMS

MPLAB® ICE 2000 and MPLAB® ICE 4000 Emulator Systems

HOW DO I ORDER MPLAB® ICE?

Ordering MPLAB® ICE is as easy as 1, 2, and 3!

- NOTE 1:** Choose your PICmicro® MCU.
2: Choose your PICmicro® MCU package.
3: Find the right line on the next few pages for MPLAB® ICE part numbers. You're ready to order.

A COMPLETE MPLAB® ICE SYSTEM

MPLAB® ICE is a modular emulator system with interchangeable components allowing the system to be easily configured to emulate different PICmicro® MCUs. Since this emulator supports package-specific emulation, customers need to know which device and package they intend to emulate. Then, the customer can use the *Cross Reference Parts List* on the following pages to identify the part numbers required to complete an MPLAB® ICE system. A complete system consists of:

- NOTE 1:** An emulator pod (including among other things the host-to-pod parallel cable and power supply)
2: A processor module
3: A device adapter
4: A transition socket

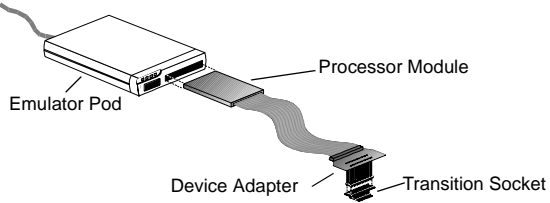

An MPLAB® ICE emulator system is ordered as separate components. Knowing the terms will make it easy to order and use the MPLAB® ICE emulator system. Read more about each component:

1. Emulator Pod

The MPLAB® ICE 2000 and MPLAB® ICE 4000 are full-featured emulator pods containing a main board with an additional board for expanded trace memory and complex control logic. The pods come with a standard parallel interface cable that connects the pods to the parallel port of the PC and a power supply. MPLAB® ICE 4000 also includes a USB interface cable that connects the pod to the USB port.

2. Processor Module

The processor module is a PICmicro®, device-specific module that is inserted into the emulator pod. The processor module contains the emulator chip, logic, and low-voltage circuitry. A flex cable extends from the processor module and is connected to the device adapter at the target application.

3. Device Adapter

The device adapter provides a common interface for the PICmicro® MCU being emulated. This adapter contains a special device that provides an oscillator clock allowing the user to accurately emulate the RC characteristics of the PICmicro® MCU. The device adapter provides emulation support for standard DIP and PLCC styles. For emulation support of other packages, a transition socket is needed along with the device adapter.

4. Transition Socket

The transition sockets are available in various styles to allow the common device adapter to be translated to support surface-mount packages, such as SOIC, SSOP, PQFP, TQFP and MLF.

PRO MATE® II and MPLAB® PM3 Programmers

The PRO MATE® II Programmer (DV007003) and the MPLAB® PM3 Programmer (DV007004) are Microchip's production rated programmers, which can be operated stand-alone or with a PC using MPLAB® IDE (included free). They come complete with accessories needed to connect to a host system, including a power supply and cables, giving the developer complete control over the programming session. Each programmer requires a socket module (to be purchased separately), which can be selected from the following chart by identifying the devices for programming and then picking the appropriate part number from their respective columns. In-Circuit Serial Programming™ (ICSP™) can be added to the PRO MATE® II Programmer by ordering Socket Module AC004004. MPLAB® PM3 has built-in ICSP™ programming capability.

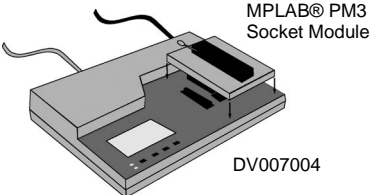
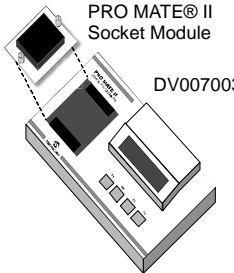

MPLAB® ICE 2000 Emulator

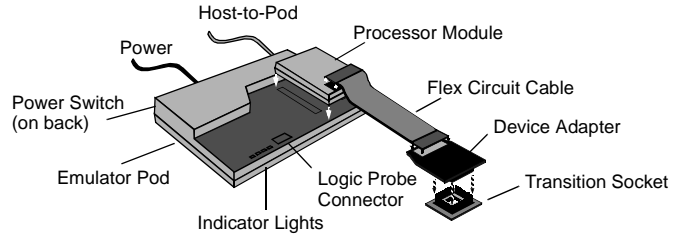

MPLAB® ICE 4000 Emulator

In-Circuit Debuggers: MPLAB® ICD 2

MPLAB® ICD 2 is a low cost, flash-based development tool that connects between the PC and the designer's target board allowing direct in-circuit debugging of the PICmicro® target microcontroller. Programs can be executed in real time or single step, watch variables established, break points set, memory read/writes accomplished and more. The MPLAB® ICD 2 can also be used as a development programmer for the microcontrollers.

MPLAB® ICE 2000 and MPLAB® ICE 4000 Emulator Systems, PRO MATE® II Programmer Socket Modules, MPLAB® In-Circuit Debugger, Software Tools, Programmers and Demonstration Boards

		MPLAB® ICE 2000 System (1)			MPLAB® ICE 4000 System (2)								
Part Number	Lead Count/ Pkg Type	Processor Module	Device Adapters	Transition Socket	Processor Module	Device Adapters	Transition Socket	PRO MATE® II Socket Module (3,4)	MPLAB® PM3 Socket Module (8)	PICSTART® Plus (5)	MPLAB® ICD 2 (6)	MPLAB® CXX Compiler	Demonstration Boards or Evaluation Kits
Analog Interface Development Tools													
MCP2120	14P												DM163008
MCP2150	18P												DM163008
MCP250XX	14P							AC254001					DV250501
MCP250XX	14SO							AC254001					
MCP2510	18P												DV251001
MCP2515	18P												DV251001
PICmicro® Microcontroller Development Tools													
PIC10F200	6OT							AC164037	AC164321	✓	AC162059		DV164101* +AC163020
PIC10F200	8P							AC164037	AC164301	✓	AC162059		DV164101*
PIC10F202	6OT							AC164037	AC164321	✓	AC162059		DV164101* +AC163020
PIC10F202	8P							AC164037	AC164301	✓	AC162059		DV164101*
PIC10F204	6OT							AC164037	AC164321	✓	AC162059		DV164101* +AC163020
PIC10F204	8P							AC164037	AC164301	✓	AC162059		DV164101*
PIC10F206	6OT							AC164037	AC164321	✓	AC162059		DV164101* +AC163020
PIC10F206	8P							AC164037	AC164301	✓	AC162059		DV164101*
PIC12C508	8P, 8JW	PCM16XA0	DVA12XP080					AC124001	AC164301	✓			DM163001, DVMCPA
PIC12C508	8SM	PCM16XA0	DVA12XP080	XLT08SO				AC124001	AC164312				
PIC12C508A	8P, 8JW	PCM16XA0	DVA12XP080					AC124001	AC164301	✓			DM163001, DVMCPA
PIC12C508A	8SM	PCM16XA0	DVA12XP080	XLT08SO				AC124001	AC164312				
PIC12C508A	8SN	PCM16XA0	DVA12XP080	XLT08SO				AC164026	AC164302				
PIC12C508A	8MF	PCM16XA0	DVA12XP080	XLT08DFN				AC124001 +AC164032	AC164301 +AC164032	AC164032			
PIC12C509	8P, 8JW	PCM16XA0	DVA12XP080					AC124001	AC164301	✓			DM163001, DVMCPA
PIC12C509	8SM	PCM16XA0	DVA12XP080	XLT08SO				AC124001	AC164312				
PIC12C509A	8P, 8JW	PCM16XA0	DVA12XP080					AC124001	AC164301	✓			DM163001, DVMCPA
PIC12C509A	8SM	PCM16XA0	DVA12XP080	XLT08SO				AC124001	AC164312				
PIC12C509A	8SN	PCM16XA0	DVA12XP080	XLT08SO				AC164026	AC164302				
PIC12C509A	8MF	PCM16XA0	DVA12XP080	XLT08DFN				AC124001 +AC164032	AC164301 +AC164032	AC164032			

MPLAB® ICE 2000 and MPLAB® ICE 4000 Emulator Systems, PRO MATE® II Programmer Socket Modules, MPLAB® In-Circuit Debugger, Software Tools, Programmers and Demonstration Boards

		MPLAB® ICE 2000 System (1)			MPLAB® ICE 4000 System (2)								
Part Number	Lead Count/ Pkg Type	Processor Module	Device Adapters	Transition Socket	Processor Module	Device Adapters	Transition Socket	PRO MATE® II Socket Module (3,4)	MPLAB® PM3 Socket Module (8)	PICSTART® Plus (5)	MPLAB® ICD 2 (6)	MPLAB® CXX Compiler	Demonstration Boards or Evaluation Kits
PICmicro® Microcontroller Development Tools (continued)													
PIC12C671	8P, 8JW	PCM12XA0	DVA12XP081					AC124001	AC164301	✓			
PIC12C671	8SM	PCM12XA0	DVA12XP081	XLT08SO				AC124001	AC164312				
PIC12C671	8MF	PCM12XA0	DVA12XP081	XLT08DFN				AC124001 +AC164032	AC164301 +AC164032	AC164032			
PIC12C672	8P, 8JW	PCM12XA0	DVA12XP081					AC124001	AC164301	✓			
PIC12C672	8SM	PCM12XA0	DVA12XP081	XLT08SO				AC124001	AC164312				
PIC12C672	8MF	PCM12XA0	DVA12XP081	XLT08DFN				AC124001 +AC164032	AC164301 +AC164032	AC164032			
PIC12CE518	8P, 8JW	PCM16XA0	DVA12XP080					AC124001	AC164301	✓			
PIC12CE518	8SM	PCM16XA0	DVA12XP080	XLT08SO				AC124001	AC164312				
PIC12CE518	8SN	PCM16XA0	DVA12XP080	XLT08SO				AC164026	AC164302				
PIC12CE519	8P, 8JW	PCM16XA0	DVA12XP080					AC124001	AC164301	✓			
PIC12CE519	8SM	PCM16XA0	DVA12XP080	XLT08SO				AC124001	AC164312				
PIC12CE519	8SN	PCM16XA0	DVA12XP080	XLT08SO				AC164026	AC164302				
PIC12CE673	8P, 8JW	PCM12XA0	DVA12XP081					AC124001	AC164301	✓			
PIC12CE674	8P, 8JW	PCM12XA0	DVA12XP081					AC124001	AC164301	✓			
PIC12F508	8P	PCM16XA0	DVA12XP080					AC124001	AC164301*	✓	AC162059		DM163014, DV164101*
PIC12F508	8SO	PCM16XA0	DVA12XP080	XLT08SO				AC164026	AC164302*		AC162059		
PIC12F508	8ST	PCM16XA0	DVA12XP080						AC164306*		AC162059		
PIC12F508	8MS	PCM16XA0	DVA12XP080								AC162059		
PIC12F509	8P	PCM16XA0	DVA12XP080					AC124001	AC164301*	✓	AC162059		DM163014, DV164101*
PIC12F509	8SO	PCM16XA0	DVA12XP080	XLT08SO				AC164026	AC164302*		AC162059		
PIC12F509	8ST	PCM16XA0	DVA12XP080						AC164306*		AC162059		
PIC12F509	8MS	PCM16XA0	DVA12XP080								AC162059		
PIC12F629	8P	PCM12XB0	DVA12XP081					AC124001	AC164301	✓	AC162050		DM163014, DV164101
PIC12F629	8SN	PCM12XB0	DVA12XP081	XLT08SO				AC164026	AC164302		AC162050		
PIC12F629	8MF	PCM12XB0	DVA12XP081	XLT08DFN				AC124001 +AC164032	AC164301 +AC164032	AC164032	AC162050		
PIC12F635	8P	PCM16YM0*	DVA1002	ACICE0201				AC164321	AC164301	✓	AC162057		DM163014, DV164101*
PIC12F635	8SO	PCM16YM0*	DVA1002	XLT08SO +ACICE0201				AC164321	AC164302		AC162057		

MPLAB® ICE 2000 and MPLAB® ICE 4000 Emulator Systems, PRO MATE® II Programmer Socket Modules, MPLAB® In-Circuit Debugger, Software Tools, Programmers and Demonstration Boards

		MPLAB® ICE 2000 System (1)			MPLAB® ICE 4000 System (2)								
Part Number	Lead Count/ Pkg Type	Processor Module	Device Adapters	Transition Socket	Processor Module	Device Adapters	Transition Socket	PRO MATE® II Socket Module (3,4)	MPLAB® PM3 Socket Module (8)	PICSTART® Plus (5)	MPLAB® ICD 2 (6)	MPLAB® CXX Compiler	Demonstration Boards or Evaluation Kits
PICmicro® Microcontroller Development Tools (continued)													
PIC12F675	8P	PCM12XB0	DVA12XP081					AC124001	AC164301	✓	AC162050		DM163014, DV164101
PIC12F675	8SN	PCM12XB0	DVA12XP081	XLT08SO				AC164026	AC164302		AC162050		
PIC12F675	8MF	PCM12XB0	DVA12XP081	XLT08DFN				AC124001 +AC164032	AC164301 +AC164032	AC164032	AC162050		
PIC12F683	8P	PCM12XC0*	DVA1002	ACICE0201				AC124001	AC164301	✓	AC162058		DM163014, DV164101*
PIC12F683	8SO	PCM12XC0*	DVA1002	XLT08SO +ACICE0201				AC164026	AC164302		AC162058		
PIC12F683	8MF	PCM12XC0*	DVA1002	XLT08DFN +ACICE0201					AC164301 +AC164032		AC162058		
PIC14000	28SP, 28JW	PCM14XA0	DVA14XP280					AC144001	AC164301	✓			DM143001
PIC14000	28SO	PCM14XA0	DVA14XP280	XLT28SO				AC144002	AC164302				
PIC14000	28SS	PCM14XA0	DVA14XP280	XLT28SS				AC144002	AC164307				
PIC16C52	18P	PCM16XA0	DVA16XP180					AC164001	AC164301	✓			DM163001
PIC16C52	18SO	PCM16XA0	DVA16XP180	XLT18SO				AC164002	AC164302				
PIC16C54/54A/ 54C	18P, 18JW	PCM16XA0	DVA16XP180					AC164001	AC164301	✓			DM163001
PIC16C54/54A/ 54C	18SO	PCM16XA0	DVA16XP180	XLT18SO				AC164002	AC164302				
PIC16C54/54A/ 54C	20SS	PCM16XA0	DVA16XP180	XLT20SS				AC164015	AC164307				
PIC16C55/55A	28P, 28JW	PCM16XA0	DVA16XP280	XLT28XP				AC164001	AC164301	✓			DM163001
PIC16C55/55A	28SP	PCM16XA0	DVA16XP280					AC164001	AC164301	✓			DM163001
PIC16C55/55A	28SO	PCM16XA0	DVA16XP280	XLT28SO				AC164002	AC164302				
PIC16C55/55A	28SS	PCM16XA0	DVA16XP280	XLT28SS2				AC164015	AC164307				
PIC16C56/56A	18P, 18JW	PCM16XA0	DVA16XP180					AC164001	AC164301	✓			DM163001
PIC16C56/56A	18SO	PCM16XA0	DVA16XP180	XLT18SO				AC164002	AC164302				
PIC16C56/56A	20SS	PCM16XA0	DVA16XP180	XLT20SS				AC164015	AC164307				
PIC16C57/57C	28P, 28JW	PCM16XA0	DVA16XP280	XLT28XP				AC164001	AC164301	✓			DM163001
PIC16C57/57C	28SP	PCM16XA0	DVA16XP280					AC164001	AC164301	✓			DM163001
PIC16C57/57C	28SO	PCM16XA0	DVA16XP280	XLT28SO				AC164002	AC164302				
PIC16C57/57C	28SS	PCM16XA0	DVA16XP280	XLT28SS2				AC164015	AC164307				

MPLAB® ICE 2000 and MPLAB® ICE 4000 Emulator Systems, PRO MATE® II Programmer Socket Modules, MPLAB® In-Circuit Debugger, Software Tools, Programmers and Demonstration Boards

		MPLAB® ICE 2000 System (1)			MPLAB® ICE 4000 System (2)								
Part Number	Lead Count/ Pkg Type	Processor Module	Device Adapters	Transition Socket	Processor Module	Device Adapters	Transition Socket	PRO MATE® II Socket Module (3,4)	MPLAB® PM3 Socket Module (8)	PICSTART® Plus (5)	MPLAB® ICD 2 (6)	MPLAB® CXX Compiler	Demonstration Boards or Evaluation Kits
PICmicro® Microcontroller Development Tools (continued)													
PIC16C58A/ 58B	18P, 18JW	PCM16XA0	DVA16XP180					AC164001	AC164301	✓			DM163001
PIC16C58A/ 58B	18SO	PCM16XA0	DVA16XP180	XLT18SO				AC164002	AC164302				
PIC16C58A/ 58B	20SS	PCM16XA0	DVA16XP180	XLT20SS				AC164015	AC164307				
PIC16C62A	28P, 28JW	PCM16XB1	DVA16XP282					AC164012	AC164301	✓			DM163022
PIC16C62A	28SO	PCM16XB1	DVA16XP282	XLT28SO				AC164017	AC164302				
PIC16C62A	28SS	PCM16XB1	DVA16XP282	XLT28SS				AC164021	AC164307				
PIC16C62B	28SP, 28JW	PCM16XE1	DVA16XP282					AC164012	AC164301	✓			DM163022
PIC16C62B	28ML	PCM16XE1	DVA16XP282	XLT28QFN				AC164012 +AC164031	AC164301 +AC164031	AC164031			
PIC16C62B	28SO	PCM16XE1	DVA16XP282	XLT28SO				AC164017	AC164302				
PIC16C62B	28SS	PCM16XE1	DVA16XP282	XLT28SS				AC164021	AC164307				
PIC16C63	28SP, 28JW	PCM16XB1	DVA16XP282					AC164012	AC164301	✓			DM163022, DVMCPA
PIC16C63	28SO	PCM16XB1	DVA16XP282	XLT28SO				AC164017	AC164302				
PIC16C63A	28SP, 28JW	PCM16XE1	DVA16XP282					AC164012	AC164301	✓			DM163022
PIC16C63A	28ML	PCM16XE1	DVA16XP282	XLT28QFN				AC164012 +AC164031	AC164301 +AC164031	AC164031			
PIC16C63A	28SO	PCM16XE1	DVA16XP282	XLT28SO				AC164017	AC164302				
PIC16C63A	28SS	PCM16XE1	DVA16XP282	XLT28SS				AC164021	AC164307				
PIC16C64A	40P, 40JW	PCM16XB1	DVA16XP401					AC164012	AC164301	✓			DM163022
PIC16C64A	44L	PCM16XB1	DVA16XL441					AC164013	AC164309				
PIC16C64A	44PQ	PCM16XB1	DVA16PQ441	XLT44PT				AC164014	AC164311				
PIC16C64A	44PT	PCM16XB1	DVA16PQ441	XLT44PT				AC164020	AC164305				
PIC16C65A	40P, 40JW	PCM16XB1	DVA16XP401					AC164012	AC164301	✓			DM163022
PIC16C65A	44L	PCM16XB1	DVA16XL441					AC164013	AC164309				
PIC16C65A	44PQ	PCM16XB1	DVA16PQ441	XLT44PT				AC164014	AC164311				
PIC16C65A	44PT	PCM16XB1	DVA16PQ441	XLT44PT				AC164020	AC164305				
PIC16C65B	40P, 40JW	PCM16XE1	DVA16XP401					AC164012	AC164301	✓			DM163022
PIC16C65B	44L	PCM16XE1	DVA16XL441					AC164013	AC164309				
PIC16C65B	44PQ	PCM16XE1	DVA16PQ441	XLT44PT				AC164014	AC164311				
PIC16C65B	44PT	PCM16XE1	DVA16PQ441	XLT44PT				AC164020	AC164305				

MPLAB® ICE 2000 and MPLAB® ICE 4000 Emulator Systems, PRO MATE® II Programmer Socket Modules, MPLAB® In-Circuit Debugger, Software Tools, Programmers and Demonstration Boards

		MPLAB® ICE 2000 System (1)			MPLAB® ICE 4000 System (2)								
Part Number	Lead Count/ Pkg Type	Processor Module	Device Adapters	Transition Socket	Processor Module	Device Adapters	Transition Socket	PRO MATE® II Socket Module (3,4)	MPLAB® PM3 Socket Module (8)	PICSTART® Plus (5)	MPLAB® ICD 2 (6)	MPLAB® CXX Compiler	Demonstration Boards or Evaluation Kits
PICmicro® Microcontroller Development Tools (continued)													
PIC16C66	28SP, 28JW	PCM16XE1	DVA16XP282					AC164012	AC164301	✓			DM163022
PIC16C66	28SO	PCM16XE1	DVA16XP282	XLT28SO				AC164017	AC164302				
PIC16C67	40P, 40JW	PCM16XE1	DVA16XP401					AC164012	AC164301	✓			DM163022
PIC16C67	44L	PCM16XE1	DVA16XL441					AC164013	AC164309				
PIC16C67	44PQ	PCM16XE1	DVA16PQ441	XLT44PT				AC164014	AC164311				
PIC16C67	44PT	PCM16XE1	DVA16PQ441	XLT44PT				AC164020	AC164305				
PIC16C71	18P, 18JW	PCM16XF0	DVA16XP180					AC164010	AC164301	✓			DM163001
PIC16C71	18SO	PCM16XF0	DVA16XP180	XLT18SO				AC164010	AC164302				
PIC16C72	28SP, 28JW	PCM16XB1	DVA16XP282					AC164012	AC164301	✓			DM163022
PIC16C72	28SO	PCM16XB1	DVA16XP282	XLT28SO				AC164017	AC164302				
PIC16C72	28SS	PCM16XB1	DVA16XP282	XLT28SS				AC164021	AC164307				
PIC16C72A	28SP, 28JW	PCM16XE1	DVA16XP282					AC164012	AC164301	✓			DM163022
PIC16C72A	28ML	PCM16XE1	DVA16XP282	XLT28QFN				AC164012 +AC164031	AC164301 +AC164031	AC164031			
PIC16C72A	28SO	PCM16XE1	DVA16XP282	XLT28SO				AC164017	AC164302				
PIC16C72A	28SS	PCM16XE1	DVA16XP282	XLT28SS				AC164021	AC164307				
PIC16C73A	28SP, 28JW	PCM16XB1	DVA16XP282					AC164012	AC164301	✓			DM163022
PIC16C73A	28SO	PCM16XB1	DVA16XP282	XLT28SO				AC164017	AC164302				
PIC16C73B	28SP, 28JW	PCM16XE1	DVA16XP282					AC164012	AC164301	✓			DM163022
PIC16C73B	28ML	PCM16XE1	DVA16XP282	XLT28QFN				AC164012 +AC164031	AC164301 +AC164031	AC164031			
PIC16C73B	28SO	PCM16XE1	DVA16XP282	XLT28SO				AC164017	AC164302				
PIC16C73B	28SS	PCM16XE1	DVA16XP282	XLT28SS				AC164021	AC164307				
PIC16C74A	40P, 40JW	PCM16XB1	DVA16XP401					AC164012	AC164301	✓			DM163022
PIC16C74A	44L	PCM16XB1	DVA16XL441					AC164013	AC164309				
PIC16C74A	44PQ	PCM16XB1	DVA16PQ441	XLT44PT				AC164014	AC164311				
PIC16C74A	44PT	PCM16XB1	DVA16PQ441	XLT44PT				AC164020	AC164305				
PIC16C74B	40P, 40JW	PCM16XE1	DVA16XP401					AC164012	AC164301	✓			DM163022
PIC16C74B	44L	PCM16XE1	DVA16XL441					AC164013	AC164309				
PIC16C74B	44PQ	PCM16XE1	DVA16PQ441	XLT44PT				AC164014	AC164311				
PIC16C74B	44PT	PCM16XE1	DVA16PQ441	XLT44PT				AC164020	AC164305				

MPLAB® ICE 2000 and MPLAB® ICE 4000 Emulator Systems, PRO MATE® II Programmer Socket Modules, MPLAB® In-Circuit Debugger, Software Tools, Programmers and Demonstration Boards

		MPLAB® ICE 2000 System (1)			MPLAB® ICE 4000 System (2)								
Part Number	Lead Count/ Pkg Type	Processor Module	Device Adapters	Transition Socket	Processor Module	Device Adapters	Transition Socket	PRO MATE® II Socket Module (3,4)	MPLAB® PM3 Socket Module (8)	PICSTART® Plus (5)	MPLAB® ICD 2 (6)	MPLAB® CXX Compiler	Demonstration Boards or Evaluation Kits
PICmicro® Microcontroller Development Tools (continued)													
PIC16C76	28SP, 28JW	PCM16XE1	DVA16XP282					AC164012	AC164301	✓			DM163022
PIC16C76	28SO	PCM16XE1	DVA16XP282	XLT28SO				AC164017	AC164302				
PIC16C77	40P, 40JW	PCM16XE1	DVA16XP401					AC164012	AC164301	✓			DM163022
PIC16C77	44L	PCM16XE1	DVA16XL441					AC164013	AC164309				
PIC16C77	44PQ	PCM16XE1	DVA16PQ441	XLT44PT				AC164014	AC164311				
PIC16C77	44PT	PCM16XE1	DVA16PQ441	XLT44PT				AC164020	AC164305				
PIC16C432	20P, 20JW	PCM16YB0	DVA16XP201					AC164029	AC164301				DM163005
PIC16C432	20SS	PCM16YB0	DVA16XP201	XLT20SS1				AC164029	AC164307				DM163007, DM163011
PIC16C433	18P, 18JW	PCM16YC0	DVA16XP185					AC164030	AC164301				DM163005
PIC16C433	18SS	PCM16YC0	DVA16XP185	XLT18SO				AC164030	AC164307				
PIC16C505	14P, 14JW	PCM16XA0	DVA16XP140					AC124001	AC164301	✓			
PIC16C505	14SL	PCM16XA0	DVA16XP140	XLT14SO				AC164026	AC164302				
PIC16C554	18P, 18JW	PCM16XC0	DVA16XP180					AC164010	AC164301	✓			DM163001
PIC16C554	18SO	PCM16XC0	DVA16XP180	XLT18SO				AC164010	AC164302				
PIC16C554	18SS	PCM16XC0	DVA16XP180	XLT20SS				AC164018	AV164307				
PIC16C557	28P							AC164001	AC164301				
PIC16C557	28SO							AC164002	AC164302				
PIC16C558	18P, 18JW	PCM16XC0	DVA16XP180					AC164010	AC164301	✓			DM163001
PIC16C558	18SO	PCM16XC0	DVA16XP180	XLT18SO				AC164010	AC164302				
PIC16C558	18SS	PCM16XC0	DVA16XP180	XLT20SS				AC164018	AC164307				
PIC16C620/ 620A	18P, 18JW	PCM16XC0	DVA16XP180					AC164010	AC164301	✓			DM163001
PIC16C620/ 620A	18SO	PCM16XC0	DVA16XP180	XLT18SO				AC164010	AC164302				
PIC16C620/ 620A	20SS	PCM16XC0	DVA16XP180	XLT20SS				AC164018	AC164307				
PIC16C621/ 621A	18P, 18JW	PCM16XC0	DVA16XP180					AC164010	AC164301	✓			DM163001
PIC16C621/ 621A	18SO	PCM16XC0	DVA16XP180	XLT18SO				AC164010	AC164302				
PIC16C621/ 621A	20SS	PCM16XC0	DVA16XP180	XLT20SS				AC164018	AC164307				

MPLAB® ICE 2000 and MPLAB® ICE 4000 Emulator Systems, PRO MATE® II Programmer Socket Modules, MPLAB® In-Circuit Debugger, Software Tools, Programmers and Demonstration Boards

		MPLAB® ICE 2000 System (1)			MPLAB® ICE 4000 System (2)								
Part Number	Lead Count/ Pkg Type	Processor Module	Device Adapters	Transition Socket	Processor Module	Device Adapters	Transition Socket	PRO MATE® II Socket Module (3,4)	MPLAB® PM3 Socket Module (8)	PICSTART® Plus (5)	MPLAB® ICD 2 (6)	MPLAB® CXX Compiler	Demonstration Boards or Evaluation Kits
PICmicro® Microcontroller Development Tools (continued)													
PIC16C622/ 622A	18P, 18JW	PCM16XC0	DVA16XP180					AC164010	AC164301	✓			DM163001
PIC16C622/ 622A	18SO	PCM16XC0	DVA16XP180	XLT18SO				AC164010	AC164302				
PIC16C622/ 622A	20SS	PCM16XC0	DVA16XP180	XLT20SS				AC164018	AC164307				
PIC16C642	28SP, 28JW	PCM16XD0	DVA16XP282					AC164012	AC164301*	✓			DM163022
PIC16C642	28SO	PCM16XD0	DVA16XP282	XLT28SO				AC164017	AC164302*				
PIC16C662	40P, 40JW	PCM16XD0	DVA16XP401					AC164012	AC164301*	✓			DM163022
PIC16C662	44L	PCM16XD0	DVA16XL441					AC164013	AC164309*				
PIC16C662	44PQ	PCM16XD0	DVA16PQ441	XLT44PT				AC164014	AC164311*				
PIC16C662	44PT	PCM16XD0	DVA16PQ441	XLT44PT				AC164020	AC164305*				
PIC16C710	18P, 18JW	PCM16XF0	DVA16XP180					AC164010	AC164301	✓			DM163001
PIC16C710	18SO	PCM16XF0	DVA16XP180	XLT18SO				AC164010	AC164302				
PIC16C710	20SS	PCM16XF0	DVA16XP180	XLT20SS				AC164018	AC164307				
PIC16C711	18P, 18JW	PCM16XF0	DVA16XP180					AC164010	AC164301	✓			DM163001
PIC16C711	18SO	PCM16XF0	DVA16XP180	XLT18SO				AC164010	AC164302				
PIC16C711	20SS	PCM16XF0	DVA16XP180	XLT20SS				AC164018	AC164307				
PIC16C712	18P, 18JW	PCM16XE1	DVA16XP182					AC164010	AC164301	✓			DM163001
PIC16C712	18SO	PCM16XE1	DVA16XP182	XLT18SO				AC164010	AC164302				
PIC16C712	20SS	PCM16XE1	DVA16XP182	XLT20SS				AC164018	AC164307				
PIC16C715	18P, 18JW	PCM16XG0	DVA16XP180					AC164010	AC164301*	✓			DM163001
PIC16C715	18SO	PCM16XG0	DVA16XP180	XLT18SO				AC164010	AC164302*				
PIC16C715	20SS	PCM16XG0	DVA16XP180	XLT20SS				AC164018	AC164307*				
PIC16C716	18P, 18JW	PCM16XE1	DVA16XP182					AC164010	AC164301	✓			DM163001
PIC16C716	18SO	PCM16XE1	DVA16XP182	XLT18SO				AC164010	AC164302				
PIC16C716	20SS	PCM16XE1	DVA16XP182	XLT20SS				AC164018	AC164307				
PIC16C717	18P, 18JW	PCM16XN1	DVA18XP180					AC164010	AC164301	✓			DM163001
PIC16C717	18SO	PCM16XN1	DVA18XP180	XLT18SO				AC164010	AC164302				
PIC16C717	20SS	PCM16XN1	DVA18XP180	XLT20SS				AC164018	AC164307				
PIC16C745	28SP, 28JW	PCM16XQ1	DVA16XP282					AC164012	AC164301	✓			DM163010
PIC16C745	28SO	PCM16XQ1	DVA16XP282	XLT28SO				AC164017	AC164302				

MPLAB® ICE 2000 and MPLAB® ICE 4000 Emulator Systems, PRO MATE® II Programmer Socket Modules, MPLAB® In-Circuit Debugger, Software Tools, Programmers and Demonstration Boards

		MPLAB® ICE 2000 System (1)			MPLAB® ICE 4000 System (2)								
Part Number	Lead Count/ Pkg Type	Processor Module	Device Adapters	Transition Socket	Processor Module	Device Adapters	Transition Socket	PRO MATE® II Socket Module (3,4)	MPLAB® PM3 Socket Module (8)	PICSTART® Plus (5)	MPLAB® ICD 2 (6)	MPLAB® CXX Compiler	Demonstration Boards or Evaluation Kits
PICmicro® Microcontroller Development Tools (continued)													
PIC16C765	40P	PCM16XQ1	DVA16XP401					AC164012	AC164301	✓			DM163010
PIC16C765	44L	PCM16XQ1	DVA16XL441					AC164013	AC164309				
PIC16C765	44PT	PCM16XQ1	DVA16PQ441	XLT44PT				AC164020	AC164305				
PIC16C770	20P	PCM16XN1	DVA16XP200					AC164028	AC164301	✓			DM163001
PIC16C770	20SO	PCM16XN1	DVA16XP200	XLT20SO1				AC164028	AC164302				
PIC16C770	20SS	PCM16XN1	DVA16XP200	XLT20SS1				AC164018	AC164307				
PIC16C771	20P	PCM16XN1	DVA16XP200					AC164028	AC164301	✓			DM163001
PIC16C771	20SO	PCM16XN1	DVA16XP200	XLT20SO1				AC164028	AC164302				
PIC16C771	20SS	PCM16XN1	DVA16XP200	XLT20SS1				AC164018	AC164307				
PIC16C773	28SP, 28JW	PCM16XL0	DVA16XP282					AC164012	AC164301	✓			DM163022
PIC16C773	28SO	PCM16XL0	DVA16XP282	XLT28SO				AC164017	AC164302				
PIC16C773	28SS	PCM16XL0	DVA16XP282	XLT28SS				AC164021	AC164307				
PIC16C774	40P, 40JW	PCM16XL0	DVA16XP401					AC164012	AC164301	✓			DM163022
PIC16C774	44L	PCM16XL0	DVA16XL441					AC164013	AC164309				
PIC16C774	44PQ	PCM16XL0	DVA16PQ441	XLT44PT				AC164014	AC164311				
PIC16C774	44PT	PCM16XL0	DVA16PQ441	XLT44PT				AC164020	AC164305				
PIC16C781	20P, 20JW	PCM16XW0	DVA16XP202					AC164028	AC164301	✓			DM163012
PIC16C781	20SO	PCM16XW0	DVA16XP202	XLT20SO1				AC164028	AC164302				
PIC16C781	20SS	PCM16XW0	DVA16XP202	XLT20SS1				AC164018	AC164307				
PIC16C782	20P, 20JW	PCM16XW0	DVA16XP202					AC164028	AC164301	✓			DM163012
PIC16C782	20SO	PCM16XW0	DVA16XP202	XLT20SO1				AC164028	AC164302				
PIC16C782	20SS	PCM16XW0	DVA16XP202	XLT20SS1				AC164018	AC164307				
PIC16C923	64SP	PCM16XJ0	DVA16XP640					AC164025		✓			
PIC16C923	64PT	PCM16XJ0	DVA16PQ640	XLT64PT1				AC164023	AC164319				
PIC16C923	68L, 68CL	PCM16XJ0	DVA16XL680					AC164022	AC164308	AC164024			DM163003
PIC16C924	64SP	PCM16XJ0	DVA16XP640					AC164025		✓			
PIC16C924	64PT	PCM16XJ0	DVA16PQ640	XLT64PT1				AC164023	AC164319				
PIC16C924	68L, 68CL	PCM16XJ0	DVA16XL680					AC164022	AC164308	AC164024			DM163003
PIC16C925	64PT	PCM16XT0	DVA16PQ640	XLT64PT1				AC164023	AC164319				
PIC16C925	68L	PCM16XT0	DVA16XL680					AC164022	AC164308	AC164024			DM163003
PIC16C926	64PT	PCM16XT0	DVA16PQ640	XLT64PT1				AC164023	AC164319				
PIC16C926	68L	PCM16XT0	DVA16XL680					AC164022	AC164308	AC164024			DM163003

MPLAB® ICE 2000 and MPLAB® ICE 4000 Emulator Systems, PRO MATE® II Programmer Socket Modules, MPLAB® In-Circuit Debugger, Software Tools, Programmers and Demonstration Boards

		MPLAB® ICE 2000 System (1)			MPLAB® ICE 4000 System (2)								
Part Number	Lead Count/ Pkg Type	Processor Module	Device Adapters	Transition Socket	Processor Module	Device Adapters	Transition Socket	PRO MATE® II Socket Module (3,4)	MPLAB® PM3 Socket Module (8)	PICSTART® Plus (5)	MPLAB® ICD 2 (6)	MPLAB® CXX Compiler	Demonstration Boards or Evaluation Kits
PICmicro® Microcontroller Development Tools (continued)													
PIC16CE623	18P, 18JW	PCM16XC0	DVA16XP180					AC164010	AC164301	✓			DM163001
PIC16CE623	18SO	PCM16XC0	DVA16XP180	XLT18SO				AC164010	AC164302				
PIC16CE623	20SS	PCM16XC0	DVA16XP180	XLT20SS				AC164018	AC164307				
PIC16CE624	18P, 18JW	PCM16XC0	DVA16XP180					AC164010	AC164301	✓			DM163001
PIC16CE624	18SO	PCM16XC0	DVA16XP180	XLT18SO				AC164010	AC164302				
PIC16CE624	20SS	PCM16XC0	DVA16XP180	XLT20SS				AC164018	AC164307				
PIC16CE625	18P, 18JW	PCM16XC0	DVA16XP180					AC164010	AC164301	✓			DM163001
PIC16CE625	18SO	PCM16XC0	DVA16XP180	XLT18SO				AC164010	AC164302				
PIC16CE625	20SS	PCM16XC0	DVA16XP180	XLT20SS				AC164018	AC164307				
PIC16F54	18P	PCM16XA0	DVA16XP180					AC164001	AC164301	✓	✓		DM163001
PIC16F54	18SO	PCM16XA0	DVA16XP180	XLT18SO				AC164002	AC164302		✓		
PIC16F54	20SS	PCM16XA0	DVA16XP180	XLT20SS				AC164015	AC164307		✓		
PIC16F57	28SP	PCM16XA0	DVA16XP280					AC164001	AC164301	✓	✓		DM163001
PIC16F57	28SO	PCM16XA0	DVA16XP280	XLT28SO				AC164002	AC164302		✓		
PIC16F57	28SS	PCM16XA0	DVA16XP280	XLT28SS2				AC164015	AC164307		✓		
PIC16F72	28SP, 28JW	PCM16XS2	DVA16XP282					AC164012	AC164301	✓			DM163022
PIC16F72	28SO	PCM16XS2	DVA16XP282	XLT28SO				AC164017	AC164302				
PIC16F72	28SS	PCM16XS2	DVA16XP282	XLT28SS				AC164021	AC164307				
PIC16F73	28SP, 28JW	PCM16XS2	DVA16XP282					AC164012	AC164301	✓	✓*		DM163022
PIC16F73	28ML	PCM16XS2	DVA16XP282	XLT28QFN				AC164012 +AC164031	AC164301 +AC164031	AC164031	✓*		
PIC16F73	28SO	PCM16XS2	DVA16XP282	XLT28SO				AC164017	AC164302		✓*		
PIC16F73	28SS	PCM16XS2	DVA16XP282	XLT28SS				AC164021	AC164307		✓*		
PIC16F74	40P	PCM16XS2	DVA16XP401					AC164012	AC164301	✓	✓*		DM163022
PIC16F74	44L	PCM16XS2	DVA16XL441					AC164013	AC164309		✓*		
PIC16F74	44PT	PCM16XS2	DVA16PQ441	XLT44PT				AC164020	AC164305		✓*		
PIC16F76	28SP, 28JW	PCM16XS2	DVA16XP282					AC164012	AC164301	✓	✓*		DM163022
PIC16F76	28ML	PCM16XS2	DVA16XP282	XLT28QFN				AC164012 +AC164031	AC164301 +AC164031	AC164031	✓*		
PIC16F76	28SO	PCM16XS2	DVA16XP282	XLT28SO				AC164017	AC164302		✓*		

MPLAB® ICE 2000 and MPLAB® ICE 4000 Emulator Systems, PRO MATE® II Programmer Socket Modules, MPLAB® In-Circuit Debugger, Software Tools, Programmers and Demonstration Boards

		MPLAB® ICE 2000 System (1)			MPLAB® ICE 4000 System (2)								
Part Number	Lead Count/ Pkg Type	Processor Module	Device Adapters	Transition Socket	Processor Module	Device Adapters	Transition Socket	PRO MATE® II Socket Module (3,4)	MPLAB® PM3 Socket Module (8)	PICSTART® Plus (5)	MPLAB® ICD 2 (6)	MPLAB® CXX Compiler	Demonstration Boards or Evaluation Kits
PICmicro® Microcontroller Development Tools (continued)													
PIC16F77	40P, 40JW	PCM16XS2	DVA16XP401					AC164012	AC164301	✓	✓*		DM163022
PIC16F77	44L	PCM16XS2	DVA16XL441					AC164013	AC164309		✓*		
PIC16F77	44PQ	PCM16XS2	DVA16PQ441	XLT44PT				AC164014	AC164311		✓*		
PIC16F77	44PT	PCM16XS2	DVA16PQ441	XLT44PT				AC164020	AC164305		✓*		
PIC16F83	18P	PCM16XH1	DVA16XP180					AC164010	AC164301	✓			DM163001
PIC16F83	18SO	PCM16XH1	DVA16XP180	XLT18SO				AC164010	AC164302				
PIC16F84	18P	PCM16XH1	DVA16XP180					AC164010	AC164301	✓			DM163001
PIC16F84	18SO	PCM16XH1	DVA16XP180	XLT18SO				AC164010	AC164302				
PIC16F84A	18P	PCM16XH1	DVA16XP180					AC164010	AC164301	✓			DM163001
PIC16F84A	18SO	PCM16XH1	DVA16XP180	XLT18SO				AC164010	AC164302				
PIC16F84A	20SS	PCM16XH1	DVA16XP180	XLT20SS				AC164018	AC164307				
PIC16F87	18P	PCM16YG0	DVA16XP186					AC164010	AC164301	✓	✓		DM163014
PIC16F87	18SO	PCM16YG0	DVA16XP186	XLT18SO				AC164010	AC164302		✓		
PIC16F87	20SS	PCM16YG0	DVA16XP186	XLT20SS				AC164018	AC164307		✓		
PIC16F87	28ML	PCM16YG0	DVA16XP186	XLT28QFN2				AC164010 +AC164033	AC164301 +AC164031	AC164033	✓		
PIC16F88	18P	PCM16YG0	DVA16XP186					AC164010	AC164301	✓	✓		DM163014
PIC16F88	18SO	PCM16YG0	DVA16XP186	XLT18SO				AC164010	AC164302		✓		
PIC16F88	20SS	PCM16YG0	DVA16XP186	XLT20SS				AC164018	AC164307		✓		
PIC16F88	28ML	PCM16YG0	DVA16XP186	XLT28QFN2				AC164010 +AC164033	AC164301 +AC164031	AC164033	✓		
PIC16F505	14P	PCM16XA0	DVA16XP140					AC124001	AC164301	✓	AC162059		DM163014, DV164101
PIC16F505	14SO	PCM16XA0	DVA16XP140	XLT14SO				AC164026	AC164302		AC162059		
PIC16F505	14ST	PCM16XA0	DVA16XP140						AC164306		AC162059		
PIC16F627	18P, 18JW	PCM16XP0	DVA16XP183					AC164010	AC164301	✓			DM163001
PIC16F627	18SO	PCM16XP0	DVA16XP183	XLT18SO				AC164010	AC164302				
PIC16F627	20SS	PCM16XP0	DVA16XP183	XLT20SS				AC164018	AC164307				

MPLAB® ICE 2000 and MPLAB® ICE 4000 Emulator Systems, PRO MATE® II Programmer Socket Modules, MPLAB® In-Circuit Debugger, Software Tools, Programmers and Demonstration Boards

		MPLAB® ICE 2000 System (1)			MPLAB® ICE 4000 System (2)								
Part Number	Lead Count/ Pkg Type	Processor Module	Device Adapters	Transition Socket	Processor Module	Device Adapters	Transition Socket	PRO MATE® II Socket Module (3,4)	MPLAB® PM3 Socket Module (8)	PICSTART® Plus (5)	MPLAB® ICD 2 (6)	MPLAB® CXX Compiler	Demonstration Boards or Evaluation Kits
PICmicro® Microcontroller Development Tools (continued)													
PIC16F627A	18P	PCM16YF0	DVA16XP186					AC164010	AC164301	✓	AC162053		DM163014
PIC16F627A	18SO	PCM16YF0	DVA16XP186	XLT18SO				AC164010	AC164302		AC162053		
PIC16F627A	20SS	PCM16YF0	DVA16XP186	XLT20SS				AC164018	AC164307		AC162053		
PIC16F627A	28ML	PCM16YF0	DVA16XP186	XLT28QFN2				AC164010 +AC164033	AC164301 +AC164031	AC164033	AC162053		
PIC16F628	18P, 18JW	PCM16XP0	DVA16XP183					AC164010	AC164301	✓			DM163001
PIC16F628	18SO	PCM16XP0	DVA16XP183	XLT18SO				AC164010	AC164302				
PIC16F628	20SS	PCM16XP0	DVA16XP183	XLT20SS				AC164018	AC164307				
PIC16F628A	18P	PCM16YF0	DVA16XP186					AC164010	AC164301	✓	AC162053		DM163014
PIC16F628A	18SO	PCM16YF0	DVA16XP186	XLT18SO				AC164010	AC164302		AC162053		
PIC16F628A	20SS	PCM16YF0	DVA16XP186	XLT20SS				AC164018	AC164307		AC162053		
PIC16F628A	28ML	PCM16YF0	DVA16XP186	XLT28QFN2				AC164010 +AC164033	AC164301 +AC164031	AC164033	AC162053		
PIC16F630	14P	PCM16YD0	DVA16XP141					AC124001	AC164301	✓	AC162052		DM163014, DV164101
PIC16F630	14SO	PCM16YD0	DVA16XP141	XLT14SO				AC164026	AC164302		AC162052		
PIC16F630	14ST	PCM16YD0	DVA16XP141	XLT14SS				AC164026	AC164306		AC162052		
PIC16F636	14P	PCM16YM0	DVA1002	ACICE0207				AC124001	AC164301	✓	AC162057		
PIC16F636	14SO	PCM16YM0	DVA1002	XLT14SO +ACICE0207				AC164026	AC164302		AC162057		
PIC16F636	14ST	PCM16YM0	DVA1002	XLT14SS +ACICE0207				AC164026	AC164306		AC162057		
PIC16F648A	18P	PCM16YF0	DVA16XP186					AC164010	AC164301	✓	AC162053		DM163014
PIC16F648A	18SO	PCM16YF0	DVA16XP186	XLT18SO				AC164010	AC164302		AC162053		
PIC16F648A	20SS	PCM16YF0	DVA16XP186	XLT20SS				AC164018	AC164307		AC162053		
PIC16F648A	28ML	PCM16YF0	DVA16XP186	XLT28QFN2				AC164010 +AC164033	AC164301 +AC164031	AC164033	AC162053		
PIC16F676	14P	PCM16YD0	DVA16XP141					AC124001	AC164301	✓	AC162052		DM163014, DV164101
PIC16F676	14SO	PCM16YD0	DVA16XP141	XLT14SO				AC164026	AC164302		AC162052		
PIC16F676	14ST	PCM16YD0	DVA16XP141	XLT14SS				AC164026	AC164306		AC162052		
PIC16F684	14P	PCM16YK0	DVA1002	ACICE0207				AC124001	AC164301	✓	AC162055		DV164101
PIC16F684	14SO	PCM16YK0	DVA1002	XLT14SO +ACICE0207				AC164026	AC164302		AC162055		
PIC16F684	14ST	PCM16YK0	DVA1002	XLT14SS +ACICE0207				AC164026	AC164306		AC162055		

MPLAB® ICE 2000 and MPLAB® ICE 4000 Emulator Systems, PRO MATE® II Programmer Socket Modules, MPLAB® In-Circuit Debugger, Software Tools, Programmers and Demonstration Boards

		MPLAB® ICE 2000 System (1)			MPLAB® ICE 4000 System (2)								
Part Number	Lead Count/ Pkg Type	Processor Module	Device Adapters	Transition Socket	Processor Module	Device Adapters	Transition Socket	PRO MATE® II Socket Module (3,4)	MPLAB® PM3 Socket Module (8)	PICSTART® Plus (5)	MPLAB® ICD 2 (6)	MPLAB® CXX Compiler	Demonstration Boards or Evaluation Kits
PICmicro® Microcontroller Development Tools (continued)													
PIC16F688	14P	PCM16YL0	DVA1002	ACICE0207				AC124001	AC164301	✓	AC162056		DV164101
PIC16F688	14SO	PCM16YL0	DVA1002	XLT14SO +ACICE0207				AC164026	AC164302		AC162056		
PIC16F688	14ST	PCM16YL0	DVA1002	XLT14SS +ACICE0207				AC164026	AC164306		AC162056		
PIC16F716	18P	PCM16YJ0	DVA16XP187					AC164010	AC164301	✓	AC162054		DM163001
PIC16F716	18SO	PCM16YJ0	DVA16XP187	XLT18SO				AC164010	AC164302		AC162054		
PIC16F716	20SS	PCM16YJ0	DVA16XP187	XLT20SS				AC164018	AC164307		AC162054		
PIC16F737	28P	PCM16YH0	DVA18XP280					AC164012	AC164301	✓	✓		
PIC16F737	28SO	PCM16YH0	DVA18XP280	XLT28SO				AC164017	AC164302		✓		
PIC16F737	28SS	PCM16YH0	DVA18XP280	XLT28SS				AC164021	AC164307		✓		
PIC16F737	28ML	PCM16YH0	DVA18XP280	XLT28QFN				AC164012 +AC164031	AC164301 +AC164031		✓		
PIC16F747	40P	PCM16YH0	DVA18XP400					AC164012	AC164301	✓	✓		
PIC16F747	44PT	PCM16YH0	DVA18PQ440	XLT44PT				AC164020	AC164305		✓		
PIC16F747	44ML	PCM16YH0	DVA18XP400	XLT44QFN				AC164012 +AC164034	AC164301 +AC164034		✓		
PIC16F767	28P	PCM16YH0	DVA18XP280					AC164012	AC164301	✓	✓		
PIC16F767	28SO	PCM16YH0	DVA18XP280	XLT28SO				AC164017	AC164302		✓		
PIC16F767	28SS	PCM16YH0	DVA18XP280	XLT28SS				AC164021	AC164307		✓		
PIC16F767	28ML	PCM16YH0	DVA18XP280	XLT28QFN				AC164012 +AC164031	AC164301 +AC164031		✓		
PIC16F777	40P	PCM16YH0	DVA18XP400					AC164012	AC164301	✓	✓		
PIC16F777	44PT	PCM16YH0	DVA18PQ440	XLT44PT				AC164020	AC164305		✓		
PIC16F777	44ML	PCM16YH0	DVA18XP400	XLT44QFN				AC164012 +AC164034	AC164301 +AC164034		✓		
PIC16F818	18P	PCM16YE0	DVA16XP186					AC164010	AC164301	✓	✓		DM163014
PIC16F818	18SO	PCM16YE0	DVA16XP186	XLT18SO				AC164010	AC164302		✓		
PIC16F818	20SS	PCM16YE0	DVA16XP186	XLT20SS				AC164018	AC164307		✓		
PIC16F818	28ML	PCM16YE0	DVA16XP186	XLT28QFN2				AC164010 +AC164033	AC164301 +AC164031	AC164033	✓		
PIC16F819	18P	PCM16YE0	DVA16XP186					AC164010	AC164301	✓	✓		DM163014
PIC16F819	18SO	PCM16YE0	DVA16XP186	XLT18SO				AC164010	AC164302		✓		
PIC16F819	20SS	PCM16YE0	DVA16XP186	XLT20SS				AC164018	AC164307		✓		

MPLAB® ICE 2000 and MPLAB® ICE 4000 Emulator Systems, PRO MATE® II Programmer Socket Modules, MPLAB® In-Circuit Debugger, Software Tools, Programmers and Demonstration Boards

		MPLAB® ICE 2000 System (1)			MPLAB® ICE 4000 System (2)								
Part Number	Lead Count/ Pkg Type	Processor Module	Device Adapters	Transition Socket	Processor Module	Device Adapters	Transition Socket	PRO MATE® II Socket Module (3,4)	MPLAB® PM3 Socket Module (8)	PICSTART® Plus (5)	MPLAB® ICD 2 (6)	MPLAB® CXX Compiler	Demonstration Boards or Evaluation Kits
PICmicro® Microcontroller Development Tools (continued)													
PIC16F819	28ML	PCM16YE0	DVA16XP186	XLT28QFN2				AC164010 +AC164033	AC164301 +AC164031	AC164033	✓		
PIC16F870	28SP, 28JW	PCM16XR1	DVA16XP282					AC164012	AC164301	✓	✓		DM163022
PIC16F870	28SO	PCM16XR1	DVA16XP282	XLT28SO				AC164017	AC164302		✓		
PIC16F870	28SS	PCM16XR1	DVA16XP282	XLT28SS				AC164021	AC164307		✓		
PIC16F871	40P	PCM16XR1	DVA16XP401					AC164012	AC164301	✓	✓		DM163022
PIC16F871	44L	PCM16XR1	DVA16XL441					AC164013	AC164309		✓		
PIC16F871	44PT	PCM16XR1	DVA16PQ441	XLT44PT				AC164020	AC164305		✓		
PIC16F872	28SP	PCM16XK1	DVA16XP282					AC164012	AC164301	✓	✓		DM163022
PIC16F872	28SO	PCM16XK1	DVA16XP282	XLT28SO				AC164017	AC164302		✓		
PIC16F872	28SS	PCM16XK1	DVA16XP282	XLT28SS				AC164021	AC164307		✓		
PIC16F873	28SP	PCM16XK1	DVA16XP282					AC164012	AC164301	✓	✓		DM163022
PIC16F873	28SO	PCM16XK1	DVA16XP282	XLT28SO				AC164017	AC164302		✓		
PIC16F873A	28SP	PCM16XV0	DVA16XP282					AC164012	AC164301	✓	✓		DM163022
PIC16F873A	28SO	PCM16XV0	DVA16XP282	XLT28SO				AC164017	AC164302		✓		
PIC16F873A	28SS	PCM16XV0	DVA16XP282	XLT28SS				AC164021	AC164307		✓		
PIC16F873A	28ML	PCM16XV0	DVA16XP282	XLT28QFN				AC164012 +AC164031	AC164301 +AC164031	AC164031	✓		
PIC16F874	40P	PCM16XK1	DVA16XP401					AC164012	AC164301	✓	✓		DM163022
PIC16F874	44L	PCM16XK1	DVA16XL441					AC164013	AC164309		✓		
PIC16F874	44PQ	PCM16XK1	DVA16PQ441	XLT44PT				AC164014	AC164311		✓		
PIC16F874	44PT	PCM16XK1	DVA16PQ441	XLT44PT				AC164020	AC164305		✓		
PIC16F874A	40P	PCM16XV0	DVA16XP401					AC164012	AC164301	✓	✓		DM163022
PIC16F874A	44L	PCM16XV0	DVA16XL441					AC164013	AC164309		✓		
PIC16F874A	44PT	PCM16XV0	DVA16PQ441	XLT44PT				AC164020	AC164305		✓		
PIC16F876	28SP	PCM16XK1	DVA16XP282					AC164012	AC164301	✓	✓		DM163022
PIC16F876	28SO	PCM16XK1	DVA16XP282	XLT28SO				AC164017	AC164302		✓		
PIC16F876A	28SP	PCM16XV0	DVA16XP282					AC164012	AC164301	✓	✓		DM163022
PIC16F876A	28SO	PCM16XV0	DVA16XP282	XLT28SO				AC164017	AC164302		✓		
PIC16F876A	28SS	PCM16XV0	DVA16XP282	XLT28SS				AC164021	AC164307		✓		
PIC16F876A	28ML	PCM16XV0	DVA16XP282	XLT28QFN				AC164012 +AC164031	AC164301 +AC164031	AC164031	✓		

MPLAB® ICE 2000 and MPLAB® ICE 4000 Emulator Systems, PRO MATE® II Programmer Socket Modules, MPLAB® In-Circuit Debugger, Software Tools, Programmers and Demonstration Boards

		MPLAB® ICE 2000 System (1)			MPLAB® ICE 4000 System (2)								
Part Number	Lead Count/ Pkg Type	Processor Module	Device Adapters	Transition Socket	Processor Module	Device Adapters	Transition Socket	PRO MATE® II Socket Module (3,4)	MPLAB® PM3 Socket Module (8)	PICSTART® Plus (5)	MPLAB® ICD 2 (6)	MPLAB® CXX Compiler	Demonstration Boards or Evaluation Kits
PICmicro® Microcontroller Development Tools (continued)													
PIC16F877	40P	PCM16XK1	DVA16XP401					AC164012	AC164301	✓	✓		DM163022
PIC16F877	44L	PCM16XK1	DVA16XL441					AC164013	AC164309		✓		
PIC16F877	44PQ	PCM16XK1	DVA16PQ441	XLT44PT				AC164014	AC164311		✓		
PIC16F877	44PT	PCM16XK1	DVA16PQ441	XLT44PT				AC164020	AC164305		✓		
PIC16F877A	40P	PCM16XV0	DVA16XP401					AC164012	AC164301	✓	✓		DM163022
PIC16F877A	44L	PCM16XV0	DVA16XL441					AC164013	AC164309		✓		
PIC16F877A	44PT	PCM16XV0	DVA16PQ441	XLT44PT				AC164020	AC164305		✓		
PIC16F877A	44ML	PCM16XV0	DVA16XP401	XLT44QFN				AC164012 +AC164034	AC164301 +AC164034	AC164034	✓		
PIC16HV540	18P							AC164001	AC164301	✓			
PIC16HV540	18SO							AC164002	AC164302				
PIC16HV540	18SS							AC164015	AC164307				
PIC17C42A	40P, 40JW	PCM17XA0	DVA17XP401					AC174001	AC164301	✓			DM163001
PIC17C42A	44L	PCM17XA0	DVA17XL441					AC174002	AC164317				
PIC17C42A	44PQ	PCM17XA0	DVA17PQ441	XLT44PT				AC174004	AC164316				
PIC17C42A	44PT	PCM17XA0	DVA17PQ441	XLT44PT				AC174005	AC164315				
PIC17C43	40P, 40JW	PCM17XA0	DVA17XP401					AC174001	AC164301	✓			DM163001
PIC17C43	44L	PCM17XA0	DVA17XL441					AC174002	AC164317				
PIC17C43	44PQ	PCM17XA0	DVA17PQ441	XLT44PT				AC174004	AC164316				
PIC17C43	44PT	PCM17XA0	DVA17PQ441	XLT44PT				AC174005	AC164315				
PIC17C44	40P, 40JW	PCM17XA0	DVA17XP401					AC174001	AC164301	✓			DM163001
PIC17C44	44L	PCM17XA0	DVA17XL441					AC174002	AC164317				
PIC17C44	44PQ	PCM17XA0	DVA17PQ441	XLT44PT				AC174004	AC164316				
PIC17C44	44PT	PCM17XA0	DVA17PQ441	XLT44PT				AC174005	AC164315				
PIC17C752	68L	PCM17XA0	DVA17XL681					AC174007	AC164308*	AC164024			DM173001
PIC17C752	64PT	PCM17XA0	DVA17PQ641	XLT64PT2				AC174008	AC164319*				
PIC17C756/ 756A	68L, 68CL	PCM17XA0	DVA17XL681					AC174007	AC164308*	AC164024			DM173001
PIC17C756/ 756A	64PT	PCM17XA0	DVA17PQ641	XLT64PT2				AC174008	AC164319*				
PIC17C762	84L	PCM17XA0	DVA17XL841					AC174012	AC164318	AC164027			DM173001
PIC17C762	80PT	PCM17XA0	DVA17PQ801	XLT80PT				AC174011	AC164320				

MPLAB® ICE 2000 and MPLAB® ICE 4000 Emulator Systems, PRO MATE® II Programmer Socket Modules, MPLAB® In-Circuit Debugger, Software Tools, Programmers and Demonstration Boards

		MPLAB® ICE 2000 System (1)			MPLAB® ICE 4000 System (2)								
Part Number	Lead Count/ Pkg Type	Processor Module	Device Adapters	Transition Socket	Processor Module	Device Adapters	Transition Socket	PRO MATE® II Socket Module (3,4)	MPLAB® PM3 Socket Module (8)	PICSTART® Plus (5)	MPLAB® ICD 2 (6)	MPLAB® CXX Compiler	Demonstration Boards or Evaluation Kits
PICmicro® Microcontroller Development Tools (continued)													
PIC17C766	84L, 84CL	PCM17XA0	DVA17XL841					AC174012	AC164318	AC164027			DM173001
PIC17C766	80PT	PCM17XA0	DVA17PQ801	XLT80PT				AC174011	AC164320				
PIC18C242	28SP, 28JW	PCM18XA0	DVA16XP282					AC164012	AC164301	✓		SW006011	DM163022
PIC18C242	28SO	PCM18XA0	DVA16XP282	XLT28SO				AC164017	AC164302			SW006011	
PIC18C252	28SP	PCM18XA0	DVA16XP282					AC164012	AC164301	✓		SW006011	DM163022
PIC18C252	28JW	PCM18XA0	DVA16XP282	XLT28XP				AC164012	AC164301			SW006011	DM163022
PIC18C252	28SO	PCM18XA0	DVA16XP282	XLT28SO				AC164017	AC164302			SW006011	
PIC18C442	40P, 40JW	PCM18XA0	DVA16XP401					AC164012	AC164301	✓		SW006011	DM163022
PIC18C442	44L	PCM18XA0	DVA16XL441					AC164013	AC164309			SW006011	
PIC18C442	44PT	PCM18XA0	DVA16PQ441	XLT44PT				AC164020	AC164305			SW006011	
PIC18C452	40P, 40JW	PCM18XA0	DVA16XP401					AC164012	AC164301	✓		SW006011	DM163022
PIC18C452	44L	PCM18XA0	DVA16XL441					AC164013	AC164309			SW006011	
PIC18C452	44PT	PCM18XA0	DVA16PQ441	XLT44PT				AC164020	AC164305			SW006011	
PIC18C601	68L				PMF18WB1	DAF18-1	XLT68L1	AC174007	AC164308		✓	SW006011	DM163006
PIC18C601	64PT				PMF18WB1	DAF18-1	XLT64PT2	AC174008	AC164303		✓	SW006011	
PIC18C658	68L	PCM18XB0	DVA18XL680					AC174007	AC164308	✓ (8)		SW006011	DM163007
PIC18C658	64PT	PCM18XB0	DVA18PQ640	XLT64PT2				AC174008	AC164303			SW006011	
PIC18C801	80PT				PMF18WB1	DAF18-1	XLT80PT	AC174011	AC164304		✓	SW006011	
PIC18C801	84L				PMF18WB1	DAF18-1	XLT84L1	AC174012	AC164310		✓	SW006011	DM163006
PIC18C858	84L	PCM18XB0	DVA18XL840					AC174012	AC164310	✓ (8)		SW006011	DM163007
PIC18C858	80PT	PCM18XB0	DVA18PQ800	XLT80PT				AC174011	AC164304			SW006011	
PIC18F242	28SP	PCM18XH0	DVA16XP282 or DVA18XP280		PMF18WC0	DAF18-2	ACICE0204	AC164012	AC164301	✓	✓	SW006011	DM163022
PIC18F242	28SO	PCM18XH0	DVA16XP282 or DVA18XP280	XLT28SO	PMF18WC0	DAF18-2	XLT28SO	AC164017	AC164302		✓	SW006011	
PIC18F248	28SP	PCM18XD1	DVA16XP282					AC164012	AC164301	✓	✓	SW006011	DM163022
PIC18F248	28SO	PCM18XD1	DVA16XP282	XLT28SO				AC164017	AC164302		✓	SW006011	
PIC18F252	28SP	PCM18XH0	DVA16XP282 or DVA18XP280		PMF18WC0	DAF18-2	ACICE0204	AC164012	AC164301	✓	✓	SW006011	DM163022
PIC18F252	28SO	PCM18XH0	DVA16XP282 or DVA18XP280	XLT28SO	PMF18WC0	DAF18-2	XLT28SO	AC164017	AC164302		✓	SW006011	
PIC18F258	28SP	PCM18XD1	DVA16XP282					AC164012	AC164301	✓	✓	SW006011	DM163022, DM163011
PIC18F258	28SO	PCM18XD1	DVA16XP282	XLT28SO				AC164017	AC164302		✓	SW006011	

MPLAB® ICE 2000 and MPLAB® ICE 4000 Emulator Systems, PRO MATE® II Programmer Socket Modules, MPLAB® In-Circuit Debugger, Software Tools, Programmers and Demonstration Boards

		MPLAB® ICE 2000 System (1)			MPLAB® ICE 4000 System (2)								
Part Number	Lead Count/ Pkg Type	Processor Module	Device Adapters	Transition Socket	Processor Module	Device Adapters	Transition Socket	PRO MATE® II Socket Module (3,4)	MPLAB® PM3 Socket Module (8)	PICSTART® Plus (5)	MPLAB® ICD 2 (6)	MPLAB® CXX Compiler	Demonstration Boards or Evaluation Kits
PICmicro® Microcontroller Development Tools (continued)													
PIC18F442	40P	PCM18XH0	DVA16XP401 or DVA18XP400		PMF18WC0	DAF18-2	ACICE0206	AC164012	AC164301	✓	✓	SW006011	DM163022
PIC18F442	44L	PCM18XH0	DVA16XL441		PMF18WC0	DAF18-3*	XLT44L2	AC164013	AC164309		✓	SW006011	
PIC18F442	44PT	PCM18XH0	DVA16PQ441 or DVA18PQ440	XLT44PT	PMF18WC0	DAF18-3*	XLT44PT	AC164020	AC164305		✓	SW006011	
PIC18F448	40P	PCM18XD1	DVA16XP401					AC164012	AC164301	✓	✓	SW006011	DM163022
PIC18F448	44L	PCM18XD1	DVA16XL441					AC164013	AC164309		✓	SW006011	
PIC18F448	44PT	PCM18XD1	DVA16PQ441	XLT44PT				AC164020	AC164305		✓	SW006011	
PIC18F452	40P	PCM18XH0	DVA16XP401		PMF18WC0	DAF18-2	ACICE0206	AC164012	AC164301	✓	✓	SW006011	DM163022
PIC18F452	44L	PCM18XH0	DVA16XL441		PMF18WC0	DAF18-3*	XLT44L2	AC164013	AC164309		✓	SW006011	
PIC18F452	44PT	PCM18XH0	DVA16PQ441	XLT44PT	PMF18WC0	DAF18-3*	XLT44PT	AC164020	AC164305		✓	SW006011	
PIC18F458	40P	PCM18XD1	DVA16XP401					AC164012	AC164301	✓	✓	SW006011	DM163022, DM163011
PIC18F458	44L	PCM18XD1	DVA16XL441					AC164013	AC164309		✓	SW006011	
PIC18F458	44PT	PCM18XD1	DVA16PQ441	XLT44PT				AC164020	AC164305		✓	SW006011	
PIC18F1220	18P	PCM18XJ0	DVA18XP180		PMF18WD0	DAF18-2	ACICE0202	AC164010	AC164301	✓*	✓	SW006011	DM163014
PIC18F1220	18SO	PCM18XJ0	DVA18XP180	XLT18SO	PMF18WD0	DAF18-2	XLT18SO	AC164010	AC164302		✓	SW006011	
PIC18F1220	20SS	PCM18XJ0	DVA18XP180	XLT20SS	PMF18WD0	DAF18-2	XLT20SS	AC164018	AC164307		✓	SW006011	
PIC18F1220	28ML	PCM18XJ0	DVA18XP180	XLT28QFN2	PMF18WD0	DAF18-2	XLT28QFN2	AC164010 +AC164033	AC164301 +AC164031	AC164033*	✓	SW006011	
PIC18F1320	18P	PCM18XJ0	DVA18XP180		PMF18WD0	DAF18-2	ACICE0202	AC164010	AC164301	✓*	✓	SW006011	DM163014
PIC18F1320	18SO	PCM18XJ0	DVA18XP180	XLT18SO	PMF18WD0	DAF18-2	XLT18SO	AC164010	AC164302		✓	SW006011	
PIC18F1320	20SS	PCM18XJ0	DVA18XP180	XLT20SS	PMF18WD0	DAF18-2	XLT20SS	AC164018	AC164307		✓	SW006011	
PIC18F1320	28ML	PCM18XJ0	DVA18XP180	XLT28QFN2	PMF18WD0	DAF18-2	XLT28QFN2	AC164010 +AC164033	AC164301 +AC164031	AC164033*	✓	SW006011	
PIC18F2220	28SP	PCM18XH0	DVA18XP280		PMF18WC0	DAF18-2	ACICE0204	AC164012	AC164301	✓*	✓	SW006011	
PIC18F2220	28SO	PCM18XH0	DVA18XP280	XLT28SO	PMF18WC0	DAF18-2	XLT28SO	AC164017	AC164302		✓	SW006011	
PIC18F2320	28SP	PCM18XH0	DVA18XP280		PMF18WC0	DAF18-2	ACICE0204	AC164012	AC164301	✓*	✓	SW006011	
PIC18F2320	28SO	PCM18XH0	DVA18XP280	XLT28SO	PMF18WC0	DAF18-2	XLT28SO	AC164017	AC164302		✓	SW006011	
PIC18F2331	28SP	PCM18XL0	DVA18XP280		PMF18WF0*	DAF18-4*	ACICE0204	AC164035	AC164301	✓*	✓	SW006011	DM183011
PIC18F2331	28SO	PCM18XL0	DVA18XP280	XLT28SO	PMF18WF0*	DAF18-4*	XLT28SO	AC164036	AC164302		✓	SW006011	
PIC18F2431	28SP	PCM18XL0	DVA18XP280		PMF18WF0*	DAF18-4*	ACICE0204	AC164035	AC164301	✓*	✓	SW006011	DM183011
PIC18F2431	28SO	PCM18XL0	DVA18XP280	XLT28SO	PMF18WF0*	DAF18-4*	XLT28SO	AC164036	AC164302		✓	SW006011	

MPLAB® ICE 2000 and MPLAB® ICE 4000 Emulator Systems, PRO MATE® II Programmer Socket Modules, MPLAB® In-Circuit Debugger, Software Tools, Programmers and Demonstration Boards

		MPLAB® ICE 2000 System (1)			MPLAB® ICE 4000 System (2)								
Part Number	Lead Count/ Pkg Type	Processor Module	Device Adapters	Transition Socket	Processor Module	Device Adapters	Transition Socket	PRO MATE® II Socket Module (3,4)	MPLAB® PM3 Socket Module (8)	PICSTART® Plus (5)	MPLAB® ICD 2 (6)	MPLAB® CXX Compiler	Demonstration Boards or Evaluation Kits
PICmicro® Microcontroller Development Tools (continued)													
PIC18F2439	28P							AC164012	AC164301*	✓*	✓	SW006011	
PIC18F2439	28SO							AC164017	AC164302*		✓	SW006011	
PIC18F2510	28SP	PCM18XN0*	DVA18XP280		PMF18WHO*	DAF18-4*	ACICE0204	AC164012*	AC164301*	✓*	✓*	SW006011	DM163022
PIC18F2510	28SO	PCM18XN0*	DVA18XP280	XLT28SO	PMF18WHO*	DAF18-4*	XLT28SO	AC164017*	AC164302*		✓*	SW006011	
PIC18F2510	28ML	PCM18XN0*	DVA18XP280	XLT28QFN	PMF18WHO*	DAF18-4*	TBD		AC164301* +AC164031		✓*	SW006011	
PIC18F2515	28SP	PCM18XN0*	DVA18XP280		PMF18WHO*	DAF18-4*	ACICE0204	AC164012*	AC164301*	✓*	✓*	SW006011	
PIC18F2515	28SO	PCM18XN0*	DVA18CP280	XLT28SO	PMF18WHO*	DAF18-4*	XLT28SO	AC164017*	AC164302*		✓*	SW006011	
PIC18F2520	28SP	PCM18XN0*	DVA18XP280		PMF18WHO*	DAF18-4*	ACICE0204	AC164012*	AC164301*	✓*	✓*	SW006011	DM163022
PIC18F2520	28SO	PCM18XN0*	DVA18XP280	XLT28SO	PMF18WHO*	DAF18-4*	XLT28SO	AC164017*	AC164302*		✓*	SW006011	
PIC18F2520	28ML	PCM18XN0*	DVA18XP280	XLT28QFN	PMF18WHO*	DAF18-4*	TBD		AC164301* +AC164031		✓*	SW006011	
PIC18F2525	28SP	PCM18XN0*	DVA18XP280		PMF18WHO*	DAF18-4*	ACICE0204	AC164012*	AC164301*	✓*	✓*	SW006011	
PIC18F2525	28SO	PCM18XN0*	DVA18XP280	XLT28SO	PMF18WHO*	DAF18-4*	XLT28SO	AC164017*	AC164302*		✓*	SW006011	
PIC18F2539	28P							AC164012	AC164301*	✓*	✓	SW006011	
PIC18F2539	28SO							AC164017	AC164302*		✓	SW006011	
PIC18F2585	28SP	PCM18XP0*	DVA18XP280		PMF18WJ0*	DAF18-4*	ACICE0204	AC164012*	AC164301*	✓*	✓*	SW006011	
PIC18F2585	28SO	PCM18XP0*	DVA18XP280	XLT28SO	PMF18WJ0*	DAF18-4*	XLT28SO	AC164017*	AC164302*		✓*	SW006011	
PIC18F2586	28SP	PCM18XP0*	DVA18XP280		PMF18WJ0*	DAF18-4*	ACICE0204	AC164012*	AC164301*	✓*	✓*	SW006011	
PIC18F2586	28SO	PCM18XP0*	DVA18XP280	XLT28SO	PMF18WJ0*	DAF18-4*	XLT28SO	AC164017*	AC164302*		✓*	SW006011	
PIC18F2610	28SP	PCM18XN0*	DVA18XP280		PMF18WHO*	DAF18-4*	ACICE0204	AC164012*	AC164301*	✓*	✓*	SW006011	
PIC18F2610	28SO	PCM18XN0*	DVA18XP280	XLT28SO	PMF18WHO*	DAF18-4*	XLT28SO	AC164017*	AC164302*		✓*	SW006011	
PIC18F2620	28SP	PCM18XN0*	DVA18XP280		PMF18WHO*	DAF18-4*	ACICE0204	AC164012*	AC164301*	✓*	✓*	SW006011	
PIC18F2620	28SO	PCM18XN0*	DVA18XP280	XLT28SO	PMF18WHO*	DAF18-4*	XLT28SO	AC164017*	AC164302*		✓*	SW006011	
PIC18F2680	28SP	PCM18XP0*	DVA18XP280		PMF18WJ0*	DAF18-4*	ACICE0204	AC164012*	AC164301*	✓*	✓*	SW006011	
PIC18F2680	28SO	PCM18XP0*	DVA18XP280	XLT28SO	PMF18WJ0*	DAF18-4*	XLT28SO	AC164017*	AC164302*		✓*	SW006011	
PIC18F2681	28SP	PCM18XP0*	DVA18XP280		PMF18WJ0*	DAF18-4*	ACICE0204	AC164012*	AC164301*	✓*	✓*	SW006011	
PIC18F2681	28SO	PCM18XP0*	DVA18XP280	XLT28SO	PMF18WJ0*	DAF18-4*	XLT28SO	AC164017*	AC164302*		✓*	SW006011	
PIC18F4220	40P	PCM18XH0	DVA18XP400		PMF18WC0	DAF18-2	ACICE0206	AC164012	AC164301	✓*	✓	SW006011	
PIC18F4220	44ML	PCM18XH0	DVA18XP400	XLT44QFN	PMF18WC0	DAF18-3*	XLT44QFN	AC164012 +AC164034	AC164301 +AC164034	AC164034*	✓	SW006011	
PIC18F4220	44PT	PCM18XH0	DVA18PQ440	XLT44PT	PMF18WC0	DAF18-3*	XLT44PT	AC164020	AC164305		✓	SW006011	

MPLAB® ICE 2000 and MPLAB® ICE 4000 Emulator Systems, PRO MATE® II Programmer Socket Modules, MPLAB® In-Circuit Debugger, Software Tools, Programmers and Demonstration Boards

		MPLAB® ICE 2000 System (1)			MPLAB® ICE 4000 System (2)								
Part Number	Lead Count/ Pkg Type	Processor Module	Device Adapters	Transition Socket	Processor Module	Device Adapters	Transition Socket	PRO MATE® II Socket Module (3,4)	MPLAB® PM3 Socket Module (8)	PICSTART® Plus (5)	MPLAB® ICD 2 (6)	MPLAB® CXX Compiler	Demonstration Boards or Evaluation Kits
PICmicro® Microcontroller Development Tools (continued)													
PIC18F4320	40P	PCM18XH0	DVA18XP400		PMF18WC0	DAF18-2	ACICE0206	AC164012	AC164301	✓*	✓	SW006011	
PIC18F4320	44ML	PCM18XH0	DVA18XP400	XLT44QFN	PMF18WC0	DAF18-3*	XLT44QFN	AC164012 +AC164034	AC164301 +AC164034	AC164034*	✓	SW006011	
PIC18F4320	44PT	PCM18XH0	DVA18PQ440	XLT44PT	PMF18WC0	DAF18-3*	XLT44PT	AC164020	AC164305		✓	SW006011	
PIC18F4331	40P	PCM18XL0	DVA18XP400		PMF18WF0*	DAF18-4*	ACICE0206	AC164012	AC164301	✓	✓	SW006011	DM183011
PIC18F4331	44PT	PCM18XL0	DVA18PQ440	XLT44PT	PMF18WF0*	DAF18-5*	XLT44PT	AC164020	AC164305		✓	SW006011	
PIC18F4331	44ML	PCM18XL0	DVA18XP400	XLT44QFN	PMF18WF0*	DAF18-5*	XLT44QFN	AC164012 +AC164034	AC164301 +AC164034		✓	SW006011	
PIC18F4431	40P	PCM18XL0	DVA18XP400		PMF18WF0*	DAF18-4*	ACICE0206	AC164012	AC164301	✓	✓	SW006011	DM183011
PIC18F4431	44PT	PCM18XL0	DVA18PQ440	XLT44PT	PMF18WF0*	DAF18-5*	XLT44PT	AC164020	AC164305		✓	SW006011	
PIC18F4431	44ML	PCM18XL0	DVA18XP400	XLT44QFN	PMF18WF0*	DAF18-5*	XLT44QFN	AC164012 +AC164034	AC164301 +AC164034		✓	SW006011	
PIC18F4439	40P							AC164012	AC164301*	✓*	✓	SW006011	
PIC18F4439	44ML							AC164012 +AC164034	AC164301* +AC164034	AC164034*	✓	SW006011	
PIC18F4439	44PT							AC164020	AC164305*		✓	SW006011	
PIC18F4510	40P	PCM18XN0*	DVA18XP400		PMF18WH0*	DAF18-4*	ACICE0206	AC164012*	AC164301*	✓*	✓*	SW006011	DM163022
PIC18F4510	44PT	PCM18XN0*	DVA18PQ440	XLT44PT	PMF18WH0*	DAF18-5*	XLT44PT	AC164020*	AC164305*		✓*	SW006011	
PIC18F4510	44ML	PCM18XN0*	DVA18XP400	XLT44QFN	PMF18WH0*	DAF18-5*	XLT44QFN	AC164012* +AC164034	AC164301* +AC164034		✓*	SW006011	
PIC18F4515	40P	PCM18XN0*	DVA18XP400		PMF18WH0*	DAF18-4*	ACICE0206	AC164012*	AC164301*	✓*	✓*	SW006011	
PIC18F4515	44PT	PCM18XN0*	DVA18PQ440	XLT44PT	PMF18WH0*	DAF18-5*	XLT44PT	AC164020*	AC164305*		✓*	SW006011	
PIC18F4515	44ML	PCM18XN0*	DVA18XP400	XLT44QFN	PMF18WH0*	DAF18-5*	XLT44QFN	AC164012* +AC164034	AC164301* +AC164034		✓*	SW006011	
PIC18F4520	40P	PCM18XN0*	DVA18XP400		PMF18WH0*	DAF18-4*	ACICE0206	AC164012*	AC164301*	✓*	✓*	SW006011	DM163022
PIC18F4520	44PT	PCM18XN0*	DVA18PQ440	XLT44PT	PMF18WH0*	DAF18-5*	XLT44PT	AC164020*	AC164305*		✓*	SW006011	
PIC18F4520	44ML	PCM18XN0*	DVA18XP400	XLT44QFN	PMF18WH0*	DAF18-5*	XLT44QFN	AC164012* +AC164034	AC164301* +AC164034		✓*	SW006011	
PIC18F4525	40P	PCM18XN0*	DVA18XP400		PMF18WH0*	DAF18-4*	ACICE0206	AC164012*	AC164301*	✓*	✓*	SW006011	
PIC18F4525	44PT	PCM18XN0*	DVA18PQ440	XLT44PT	PMF18WH0*	DAF18-5*	XLT44PT	AC164020*	AC164305*		✓*	SW006011	
PIC18F4525	44ML	PCM18XN0*	DVA18XP400	XLT44QFN	PMF18WH0*	DAF18-5*	XLT44QFN	AC164012* +AC164034	AC164301* +AC164034		✓*	SW006011	
PIC18F4539	40P							AC164012	AC164301*	✓*	✓	SW006011	
PIC18F4539	44ML							AC164012 +AC164034	AC164301* +AC164034	AC164034*	✓	SW006011	
PIC18F4539	44PT							AC164020	AC164305*		✓	SW006011	

MPLAB® ICE 2000 and MPLAB® ICE 4000 Emulator Systems, PRO MATE® II Programmer Socket Modules, MPLAB® In-Circuit Debugger, Software Tools, Programmers and Demonstration Boards

		MPLAB® ICE 2000 System (1)			MPLAB® ICE 4000 System (2)								
Part Number	Lead Count/ Pkg Type	Processor Module	Device Adapters	Transition Socket	Processor Module	Device Adapters	Transition Socket	PRO MATE® II Socket Module (3,4)	MPLAB® PM3 Socket Module (8)	PICSTART® Plus (5)	MPLAB® ICD 2 (6)	MPLAB® CXX Compiler	Demonstration Boards or Evaluation Kits
PICmicro® Microcontroller Development Tools (continued)													
PIC18F4585	40P	PCM18XP0*	DVA18XP400		PMF18WJ0*	DAF18-4*	ACICE0206	AC164012*	AC164301*	✓*	✓*	SW006011	
PIC18F4585	44PT	PCM18XP0*	DVA18PQ440	XLT44PT	PMF18WJ0*	DAF18-5*	XLT44PT	AC164020*	AC164305*		✓*	SW006011	
PIC18F4585	44ML	PCM18XP0*	DVA18XP400	XLT44QFN	PMF18WJ0*	DAF18-5*	XLT44QFN	AC164012* +AC164034	AC164301* +AC164034		✓*	SW006011	
PIC18F4586	40P	PCM18XP0*	DVA18XP400		PMF18WJ0*	DAF18-4*	ACICE0206	AC164012*	AC164301*	✓*	✓*	SW006011	
PIC18F4586	44PT	PCM18XP0*	DVA18PQ440	XLT44PT	PMF18WJ0*	DAF18-5*	XLT44PT	AC164020*	AC164305*		✓*	SW006011	
PIC18F4586	44ML	PCM18XP0*	DVA18XP400	XLT44QFN	PMF18WJ0*	DAF18-5*	XLT44QFN	AC164012* +AC164034	AC164301* +AC164034		✓*	SW006011	
PIC18F4610	40P	PCM18XN0*	DVA18XP400		PMF18WHO*	DAF18-4*	ACICE0206	AC164012*	AC164301*	✓*	✓*	SW006011	
PIC18F4610	44PT	PCM18XN0*	DVA18PQ440	XLT44PT	PMF18WHO*	DAF18-5*	XLT44PT	AC164020*	AC164305*		✓*	SW006011	
PIC18F4610	44ML	PCM18XN0*	DVA18XP400	XLT44QFN	PMF18WHO*	DAF18-5*	XLT44QFN	AC164012* +AC164034	AC164301* +AC164034		✓*	SW006011	
PIC18F4620	40P	PCM18XN0*	DVA18XP400		PMF18WHO*	DAF18-4*	ACICE0206	AC164012*	AC164301*	✓*	✓*	SW006011	
PIC18F4620	44PT	PCM18XN0*	DVA18PQ440	XLT44PT	PMF18WHO*	DAF18-5*	XLT44PT	AC164020*	AC164305*		✓*	SW006011	
PIC18F4620	44ML	PCM18XN0*	DVA18XP400	XLT44QFN	PMF18WHO*	DAF18-5*	XLT44QFN	AC164012* +AC164034	AC164301* +AC164034		✓*	SW006011	
PIC18F4680	40P	PCM18XP0	DVA18XP400		PMF18WJ0*	DAF18-4*	ACICE0206	AC164012*	AC164301*	✓*	✓*	SW006011	
PIC18F4680	44PT	PCM18XP0	DVA18PQ440	XLT44PT	PMF18WJ0*	DAF18-5*	XLT44PT	AC164020*	AC164305*		✓*	SW006011	
PIC18F4680	44ML	PCM18XP0	DVA18XP400	XLT44QFN	PMF18WJ0*	DAF18-5*	XLT44QFN	AC164012* +AC164034	AC164301* +AC164034		✓*	SW006011	
PIC18F4681	40P	PCM18XP0	DVA18XP400		PMF18WJ0*	DAF18-4*	ACICE0206	AC164012*	AC1643018*	✓*	✓*	SW006011	
PIC18F4681	44PT	PCM18XP0	DVA18PQ440	XLT44PT	PMF18WJ0*	DAF18-5*	XLT44PT	AC164020*	AC1643058*		✓*	SW006011	
PIC18F4681	44ML	PCM18XP0	DVA18XP400	XLT44QFN	PMF18WJ0*	DAF18-5*	XLT44QFN	AC164012* +AC164034	AC164301* +AC164034		✓*	SW006011	
PIC18F6310	64PT	PCM18XQ0*	DVA1003*	XLT64PT2	PMF18WK0*	DAF18-6*	XLT64PT2	TBD	AC164303*		✓*	SW006011	
PIC18F6390	64PT	PCM18XQ0*	DVA1003*	XLT64PT2	PMF18WK0*	DAF18-6*	XLT64PT2	TBD	AC164303*		✓*	SW006011	
PIC18F6410	64PT	PCM18XQ0*	DVA1003*	XLT64PT2	PMF18WK0*	DAF18-6*	XLT64PT2	AC174008*	AC164303*		✓*	SW006011	
PIC18F6490	64PT	PCM18XQ0*	DVA1003*	XLT64PT2	PMF18WK0*	DAF18-6*	XLT64PT2	AC174008*	AC164303*		✓*	SW006011	
PIC18F6520	64PT	PCM18XE1	DVA18PQ640	XLT64PT2	PMF18WA1	DAF18-1	XLT64PT2	AC174008	AC164303		✓	SW006011	DM183020
PIC18F6525	64PT	PCM18XK0	DVA18PQ802	XLT64PT2	PMF18WE0	DAF18-1	XLT64PT2	AC174008	AC164303		✓	SW006011	
PIC18F6585	68L	PCM18XK0	DVA18PQ802	XLT68L1	PMF18WE0	DAF18-1	XLT68L1	AC174007	AC164308		✓	SW006011	
PIC18F6585	64PT	PCM18XK0	DVA18PQ802	XLT64PT2	PMF18WE0	DAF18-1	XLT64PT2	AC174008	AC164303		✓	SW006011	
PIC18F6620	64PT	PCM18XE1	DVA18PQ640	XLT64PT2	PMF18WA1	DAF18-1	XLT64PT2	AC174008	AC164303	✓ (7)	✓	SW006011	DM183020

MPLAB® ICE 2000 and MPLAB® ICE 4000 Emulator Systems, PRO MATE® II Programmer Socket Modules, MPLAB® In-Circuit Debugger, Software Tools, Programmers and Demonstration Boards

		MPLAB® ICE 2000 System (1)			MPLAB® ICE 4000 System (2)								
Part Number	Lead Count/ Pkg Type	Processor Module	Device Adapters	Transition Socket	Processor Module	Device Adapters	Transition Socket	PRO MATE® II Socket Module (3,4)	MPLAB® PM3 Socket Module (8)	PICSTART® Plus (5)	MPLAB® ICD 2 (6)	MPLAB® CXX Compiler	Demonstration Boards or Evaluation Kits
PICmicro® Microcontroller Development Tools (continued)													
PIC18F6621	64PT	PCM18XK0	DVA18PQ802	XLT64PT2	PMF18WE0	DAF18-1	XLT64PT2	AC174008	AC164303		✓	SW006011	
PIC18F6680	68L	PCM18XK0	DVA18PQ802	XLT68L1	PMF18WE0	DAF18-1	XLT68L1	AC174007	AC164308		✓	SW006011	
PIC18F6680	64PT	PCM18XK0	DVA18PQ802	XLT64PT2	PMF18WE0	DAF18-1	XLT64PT2	AC174008	AC164303		✓	SW006011	
PIC18F6720	64PT	PCM18XE1	DVA18PQ640	XLT64PT2	PMF18WA1	DAF18-1	XLT64PT2	AC174008	AC164303	✓ (7)	✓	SW006011	DM183020
PIC18F8310	80PT	PCM18XQ0*	DVA1003*	XLT80PT	PMF18WK0*	DAF18-6*	XLT80PT	TBD	AC164304*		✓*	SW006011	
PIC18F8390	80PT	PCM18XQ0*	DVA1003*	XLT80PT	PMF18WK0*	DAF18-6*	XLT80PT	TBD	AC164304*		✓*	SW006011	
PIC18F8410	80PT	PCM18XQ0*	DVA1003*	XLT80PT	PMF18WK0*	DAF18-6*	XLT80PT	AC174011*	AC164304*		✓*	SW006011	
PIC18F8490	80PT	PCM18XQ0*	DVA1003*	XLT80PT	PMF18WK0*	DAF18-6*	XLT80PT	AC174011*	AC164304*		✓*	SW006011	
PIC18F8520	80PT	PCM18XE1	DVA18PQ800	XLT80PT	PMF18WA1	DAF18-1	XLT80PT	AC174011	AC164304		✓	SW006011	DM183020
PIC18F8525	80PT	PCM18XK0	DVA18PQ802	XLT80PT	PMF18WE0	DAF18-1	XLT80PT	AC174011	AC164304		✓	SW006011	
PIC18F8585	80PT	PCM18XK0	DVA18PQ802	XLT80PT	PMF18WE0	DAF18-1	XLT80PT	AC174011	AC164304		✓	SW006011	
PIC18F8620	80PT	PCM18XE1	DVA18PQ800	XLT80PT	PMF18WA1	DAF18-1	XLT80PT	AC174011	AC164304	✓ (7)	✓	SW006011	DM183020
PIC18F8621	80PT	PCM18XK0	DVA18PQ802	XLT80PT	PMF18WE0	DAF18-1	XLT80PT	AC174011	AC164304		✓	SW006011	
PIC18F8680	80PT	PCM18XK0	DVA18PQ802	XLT80PT	PMF18WE0	DAF18-1	XLT80PT	AC174011	AC164304		✓	SW006011	
PIC18F8720	80PT	PCM18XE1	DVA18PQ800	XLT80PT	PMF18WA1	DAF18-1	XLT80PT	AC174011	AC164304	✓ (7)	✓	SW006011	DM183020
rfPIC® Microcontroller Development Tools													
rfPIC12C509AF/ 509AG	18SO	PCM16XA0	DVA12XP080	XLT18SO				AC124002	AC164302	✓ (7)			
rfPIC12C509AF/ 509AG	20SS	PCM16XA0	DVA12XP080	XLT20SS				AC124002	AC164307				
rfPIC12F675F	20SS	PCM12XB0	DVA12XP081	XLT20SS				AC124002	AC164307	✓ (7)*			DV164102 AC164101 AC164103
rfPIC12F675H	20SS	PCM12XB0	DVA12XP081	XLT20SS				AC124002	AC164307	✓ (7)*			
rfPIC12F675K	20SS	PCM12XB0	DVA12XP081	XLT20SS				AC124002	AC164307	✓ (7)*			DV164102 AC164102 AC164104
rfRXD0420	32LQ												DV164102
rfRXD0920	32LQ												

MPLAB® ICE 2000 and MPLAB® ICE 4000 Emulator Systems, PRO MATE® II Programmer Socket Modules, MPLAB® In-Circuit Debugger, Software Tools, Programmers and Demonstration Boards

		MPLAB® ICE 2000 System (1)			MPLAB® ICE 4000 System (2)								
Part Number	Lead Count/ Pkg Type	Processor Module	Device Adapters	Transition Socket	Processor Module	Device Adapters	Transition Socket	PRO MATE® II Socket Module (3,4)	MPLAB® PM3 Socket Module (8)	PICSTART® Plus (5)	MPLAB® ICD 2 (6)	MPLAB® CXX Compiler	Demonstration Boards or Evaluation Kits
dsPIC™ Microcontroller Development Tools													
dsPIC30F2010	28SO				PMF30XA1*	DAF30-4*	XLT28SO	AC30F004*	AC164302*		✓	SW006012	DM300017
dsPIC30F2010	28SP				PMF30XA1*	DAF30-4*	ACICE0204	AC30F004*	AC164301*		✓	SW006012	DM300017
dsPIC30F2011	18SO				PMF30XA1*	DAF30-4*	XLT18SO	AC30F005*	AC164302*		✓*	SW006012	
dsPIC30F2011	18P				PMF30XA1*	DAF30-4*	ACICE0202	AC30F005*	AC164301*		✓*	SW006012	
dsPIC30F2012	28SO				PMF30XA1*	DAF30-4*	XLT28SO	AC30F004*	AC164302*		✓*	SW006012	
dsPIC30F2012	28SP				PMF30XA1*	DAF30-4*	ACICE0204	AC30F004*	AC164301*		✓*	SW006012	
dsPIC30F3010	28SO				PMF30XA1*	DAF30-4*	XLT28SO	AC30F004*	AC164302*		✓*	SW006012	
dsPIC30F3010	28SP				PMF30XA1*	DAF30-4*	ACICE0204	AC30F004*	AC164301*		✓*	SW006012	
dsPIC30F3011	40P				PMF30XA1*	DAF30-4*	ACICE0206	AC30F003*	AC164301*		✓*	SW006012	
dsPIC30F3011	44PT				PMF30XA1*	DAF30-3*	XLT44PT or XLT44PT3	AC30F006*	AC164305*		✓*	SW006012	
dsPIC30F3012	18SO				PMF30XA1*	DAF30-4*	XLT18SO	AC30F005*	AC164302*		✓*	SW006012	
dsPIC30F3012	18P				PMF30XA1*	DAF30-4*	ACICE0202	AC30F005*	AC164301*		✓*	SW006012	
dsPIC30F3013	28SO				PMF30XA1*	DAF30-4*	XLT28SO	AC30F004*	AC164302*		✓*	SW006012	
dsPIC30F3013	28SP				PMF30XA1*	DAF30-4*	ACICE0204	AC30F004*	AC164301*		✓*	SW006012	
dsPIC30F3014	40P				PMF30XA1*	DAF30-4*	ACICE0206	AC30F003*	AC164301*		✓*	SW006012	
dsPIC30F3014	44PT				PMF30XA1*	DAF30-3*	XLT44PT or XLT44PT3	AC30F006*	AC164305*		✓*	SW006012	
dsPIC30F4011	40P				PMF30XA1*	DAF30-4*	ACICE0206	AC30F003*	AC164301*		✓*	SW006012	
dsPIC30F4011	44PT				PMF30XA1*	DAF30-3*	XLT44PT or XLT44PT3	AC30F006*	AC164305*		✓*	SW006012	
dsPIC30F4012	28SO				PMF30XA1*	DAF30-4*	XLT28SO	AC30F004*	AC164302*		✓*	SW006012	
dsPIC30F4012	28SP				PMF30XA1*	DAF30-4*	ACICE0204	AC30F004*	AC164301*		✓*	SW006012	
dsPIC30F4013	40P				PMF30XA1*	DAF30-4*	ACICE0206	AC30F003*	AC164301*		✓*	SW006012	
dsPIC30F4013	44PT				PMF30XA1*	DAF30-3*	XLT44PT or XLT44PT3	AC30F006*	AC164305*		✓*	SW006012	
dsPIC30F5011	64PT				PMF30XA1*	DAF30-2	XLT64PT2 or XLT64PT5	AC30F008*	AC164303*		✓	SW006012	
dsPIC30F5013	80PT				PMF30XA1*	DAF30-2	XLT80PT or XLT80PT3	AC30F007*	AC164304*		✓	SW006012	DM300014 DM300004-1 DM300004-2
dsPIC30F5015	64PT				PMF30XA1*	DAF30-2	XLT64PT2 or XLT64PT5	AC30F008*	AC164303*		✓*	SW006012	

MPLAB® ICE 2000 and MPLAB® ICE 4000 Emulator Systems, PRO MATE® II Programmer Socket Modules, MPLAB® In-Circuit Debugger, Software Tools, Programmers and Demonstration Boards

		MPLAB® ICE 2000 System (1)			MPLAB® ICE 4000 System (2)								
Part Number	Lead Count/ Pkg Type	Processor Module	Device Adapters	Transition Socket	Processor Module	Device Adapters	Transition Socket	PRO MATE® II Socket Module (3,4)	MPLAB® PM3 Socket Module (8)	PICSTART® Plus (5)	MPLAB® ICD 2 (6)	MPLAB® CXX Compiler	Demonstration Boards or Evaluation Kits
dsPIC™ Microcontroller Development Tools (continued)													
dsPIC30F6010	80PF				PMF30XA1*	DAF30-2	XLT80PT2	AC30F001	AC164314*		✓	SW006012	DM300020
dsPIC30F6011	64PF				PMF30XA1*	DAF30-2	XLT64PT3 or XLT64PT4	AC30F002*	AC164313*		✓	SW006012	DM300016
dsPIC30F6012	64PF				PMF30XA1*	DAF30-2	XLT64PT3 or XLT64PT4	AC30F002*	AC164313*		✓	SW006012	DM300016
dsPIC30F6013	80PF				PMF30XA1*	DAF30-2	XLT80PT2	AC30F001*	AC164314*		✓	SW006012	DM300014
dsPIC30F6014	80PF				PMF30XA1*	DAF30-2	XLT80PT2	AC30F001*	AC164314*		✓	SW006012	DM300014 DM300004-1 DM300004-2

- NOTES** 1: MPLAB® ICE 2000 pod available separately. (ICE2000)
2: MPLAB® ICE 4000 pod available separately. (ICE4000)
3: PRO MATE® II Programmer unit (no longer available). (DV007003)
4: Optional In-Circuit Serial Programming™ (ICSP™) Socket for PRO MATE® II available separately. (AC004004)
5: PICSTART® Plus (DV003001)
6: MPLAB® ICD 2 In-Circuit Debugger. Configurations are:
(DV164005) ICD 2 module, USB cable and ICD cable.
(DV164006) ICD 2 module, USB cable, ICD cable, serial cable, PICDEM™ 2 Plus and power supply.
(DV164007) ICD 2 module, USB cable, ICD cable, serial cable and power supply;
(DV164030) ICD 2 module, USB cable, ICD cable, serial cable and dsPICDEM™ Starter Demo Board;
(AC162049) ICD 2 Universal Programming Module;
(AC162051) ICD or ICD 2 28/40 PDIP Header Interface Board.
7: Custom adapter required; not available from Microchip. See "Readme" for PICSTART® Plus.
8: MPLAB® PM3 Programmer Unit available separately. (DV007004). ICSP™ function is built-in with MPLAB® PM3 Programmer.
(AC164350) MPLAB® PM3 Adapter for PRO MATE® II Socket modules.

* New product or future support. Contact Microchip web site at www.microchip.com for availability.

✓ Supported with basic configuration. If a part number is listed in the column, that part is required and available separately.

Demonstration Boards and Evaluation Kits (9)

Part Number	Description
PICmicro® Demonstration Kits	
DM143001	PICDEM™ 14A Demo Board for PIC14C000
DM163001	PICDEM™ 1 Demo Board for PIC16C5X, 55X, 62X, CE62X, 71, 710, 711, 715, 770, 771, 83, 84, and PIC17C42, 43, 44
DM163003	PICDEM™ 3 Demo Board for PIC16C923, 924, 925, 926
DM163006	PICDEM™ 18R Demo Board for PIC18C601/801
DM163014	PICDEM™ 4 Demo Board for PIC12F629, 675, PIC16F630, 676, 684, 627A, 628A, 648A, 818, 819, 87, 88, PIC18F1220, 1320
DM163022	PICDEM™ 2 Plus Demo Board for PIC16C62, 63, 64, 65, 66, 67, 72, 73, 74, 76, 77, 87X, 773, 774 and PIC18CXX2, 642, 662, and PIC18FXXX
DV164101	PICKit™ 1 8/14P Flash Development Kit for PIC12F629, 675 and PIC16F630, 676
DV164102	rfPIC® Development Kit 1
AC164101	rfPIC® Transmitter Module (433.92 MHz)
AC164102	rfPIC® Transmitter Module (315 MHz)
AC164103	rfRXD Receiver Module (433.92 MHz)
AC164104	rfRXD Receiver Module (315 MHz)
AC164120	Signal Analysis PICtail™ Daughter Board
AC163020	PIC10F2XX Programmer Adapter
AC163021	6L SOT-23 to 8P DIP Adapter Kit
DM173001	PICDEM™ 17 Demo Board for PIC17CXX
DM183011	PICDEM™ MC Demo Board for PIC18F2331, 2431, 4331, 4431
DM183020	PIC18FXX20 64/80L TQFP Demo Board for PIC18F6620, 6720, 8620, 8720, 6520, 8520
Connectivity Demonstration Kits	
DM163004-LT	PICDEM.net™ TCP/IP Demo Board (with no text book)
DM163005	PICDEM™ LIN Demo Board for PIC16C432/433 LIN bus
DM163007	PICDEM™ CAN-LIN 1 Demo Board
DM163008	MCP2120/2150 Developer's Kit for IR Communication
DM163010	PICDEM™ USB Demo Board for PIC16C7X5
DM163011	PICDEM™ CAN-LIN 2 Demo Board
DM163015	PICDEM™ CAN-LIN 3 Demo Board
DV250501	MCP250XX CAN Developer's Kit
DV251001	MCP2510/2515 CAN Developer's Kit

* Contact Microchip web site at www.microchip.com for availability.

Demonstration Boards and Evaluation Kits (9)	
Part Number	Description
Mixed Signal Control Demonstration Kits	
AC163001	PICDEM™ MSC 1 Voltage Boost Demo Board; requires DM163012
AC163002	PICDEM™ MSC 1 High Power IR Demo Board; requires DM163012
AC163003	PICDEM™ MSC 1 Delta Sigma Demo Board; requires DM163012
AC163004	PICDEM™ MSC 1 Flow Rate Sensor Demo Board; requires DM163012
DM163012	PICDEM™ MSC 1 Mixed Signal Controller Demo Board for PIC16C781/782
dsPIC™ 16-bit DSC Demonstration Kits	
DM300004-1	dsPICDEM.net™ 1 FCC/JATE PSTN Support, Ethernet NIC Demo Board
DM300004-2	dsPICDEM.net™ 2 CTR-21 PSTN Support, Ethernet NIC Demo Board
DM300014	dsPICDEM™ 1.1 General Purpose Demo Board
DM300016	dsPICDEM™ Starter Demo Board
DM300017	dsPICDEM™ 28-Pin Starter Demo Board
DM300020	dsPICDEM™ MC1 Motor Control Development Board
DM300021	dsPICDEM™ MC1H 3-Phase High Voltage Power Module
DM300022	dsPICDEM™ MC1L 3-Phase Low Voltage Power Module
dsPIC™ 16-bit DSC Software Tools	
SW300001	Digital Filter Design
SW300002	dsPIC™ V.22/V.22bis Soft Modem Library (free download: www.microchip.com)
SW300003-EVAL	dsPIC™ V.32 Soft Modem Library (Eval Copy)
SW300003, 04, 05	dsPIC™ V.32 Soft Modem Library (5K, 25K, 100K licenses, respectively)
SW300006*	dsPIC™ V.22/V.22bis Soft Modem Library by Vocal Technology
SW300010-EVAL*	dsPIC™ Speech Recognition (Eval Copy)
SW300010, 11, 12*	dsPIC™ Speech Recognition (5K, 25K, 100K licenses, respectively)
SW300020	dsPIC30 Math Library: Double-Precision Floating Point Routines
SW300021	dsPIC30 Peripheral Library: Peripheral Initialization and Control Routines
SW300022	dsPIC30 DSP Library: Data Signal Processing Library Suite (FFT, Filters)
SW300023	dsPICworks™ Visual Algorithm Analyzer: Data Analyzer and Converter Tool
SW300030	CMX Scheduler: Multi-tasking, Preemptive Scheduler for dsPIC30F
SW300060-5K, 25K, 100K	Acoustic Echo Cancellation Library
SW300031	CMX-RTX for dsPIC™ DSC: Fully Preemptive RTOS
SW300032	CMX-Tiny+ for dsPIC™ DSC: Preemptive RTOS
SW300040-EVAL, 5K, 25K, 100K	Noise Suppression Library (Eval, 5K, 25K, 100K licenses, respectively)
SW300050-EVAL, 5K, 25K, 100K	dsPIC™ Symmetric Embedded Encryption Library (Eval, 5K, 25K, 100K licenses, respectively)
SW300055-EVAL, 5K, 25K, 100K	dsPIC™ Asymmetric Embedded Encryption Library (Eval, 5K, 25K, 100K licenses, respectively)
SW300060-EVAL, 5K, 25K, 100K	Acoustic Echo Cancellation Library (Eval, 5K, 25K, 100K licenses, respectively)

* Contact Microchip web site at www.microchip.com for availability.

PowerSmart® Systems

Model Name/ Part Number	Description
PS040*	PowerTool™ Development Software for PS401 and PS402 Applications
PS042	PS401 PowerCal™ Board
PS051	PowerInfo™ 2 Configuration Interface Board for use with PS70X and PS50X.
PS052	PowerCal™ 2 Configuration Interface Board for use with PS70X and PS50X.
PS070*	PowerMate™ Development Software for PS700 Applications
PS4160-3	3-cell Li-Ion Fuel Gauge
PS4160-4	4-cell Li-Ion Fuel Gauge
PS4160EV-3	3-cell Li-Ion Fuel Gauge with PS041 PowerInfo™ Board
PS4160EV-4	4-cell Li-Ion Fuel Gauge with PS041 PowerInfo™ Board
PS4200	6-12 cell NiMH Fuel Gauge
PS4200EV	6-12 Cell NiMH Fuel Gauge with PS041 PowerInfo™ Board
PS5100*	PS501 6-12 cell NiMH Module
PS5100EV*	PS501 6-12 cell NiMH Module with PS051
PS5162	2-cell Li-Ion/Poly Fuel Gauge with safety
PS5162EV	2-cell Li-Ion/Poly Fuel Gauge with safety and PS051 PowerInfo™ 2
PS5163	3-cell Li-Ion/Poly Fuel Gauge with safety
PS5163EV	3-cell Li-Ion/Poly Fuel Gauge with safety and PS051 PowerInfo™ 2
PS5164	4-cell Li-Ion/Poly Fuel Gauge with safety
PS5164EV	4-cell Li-Ion/Poly Fuel Gauge with safety and PS051 PowerInfo™ 2
PS7051	Single Cell Li-Ion Fuel Gauge with safety
PS7052	Two Cell Li-Ion Fuel Gauge with safety
PS7070	PS700 Battery Monitor Evaluation Board
PS7070EV	PS700 Battery Monitor Evaluation Board with PS051 PowerInfo™ 2

* Contact Microchip web site at www.microchip.com for availability.

Memory Evaluation/Developer's Kits

SEEVAL® 32 Serial EEPROM Developer's Kit	DV243002	All serial EEPROMS, 24XX, 93XX, 25XX series
--	----------	---

KEELOQ® Evaluation Kits

	HCS101	HCS200/201	HCS300/301/320	HCS360/361	HCS362	HCS365/370	HCS410/412	HCS473	HCS500/515	HCS512
KEELOQ® Transponder Evaluation Kit*	–	–	–	–	–	–	DM303005	–	–	
KEELOQ® Evaluation Kit II*	DM303006	DM303006	DM303006	DM303006	DM303006	DM303006	DM303006	DM303006	DM303006	
PRO MATE® II Universal Programmer for SOIC*	AC004002	AC004002	AC004002	AC004002	AC004002	AC004003	AC004002	AC004003	–	AC164002
PRO MATE® II Universal Programmer for DIP*	AC004001	AC004001	AC004001	AC004001	AC004001	AC004007	AC004001	AC004007	–	AC164001
PRO MATE® II Universal Programmer for ICSP™*	AC004004	AC004004	AC004004	AC004004	AC004004	AC004004	AC004004	AC004004	AC004004	

*Support is limited to PRO MATE® II using MPLAB® IDE release 5.70.

Analog Evaluation/Developer's Kits

	MCP3001/02	MCP3004/08	MCP3201/02	MCP3204/08	MCP60X	MCP41XXX/ 42XXX	TC64X/64XB	TC650/51	TC652/53	TC74	TC3400/01/02/ 03/04/05
Analog Evaluation Kits											
Analog Evaluation Driver Board	DVMCPA	DVMCPA	DVMCPA	DVMCPA	–	DVMCPA					
Evaluation Board	DV3201A**	DV3204A**	DV3201A**	DV3204A**	–	DV42XXX**					
FilterLab® Active Filter Design Tool					FilterLab*						
Thermal Management Tools											
Fan Controller Demo Board							TC642Demo	TC650Demo	TC652Demo		
Fan Controller Evaluation Kit							TC642EV				
Serial Digital Thermal Sensor Demo Board										TC74Demo	
Data Converter Tools											
Sigma-Delta A/D Family Demo Board											
Sigma-Delta A/D Family Evaluation Kit											

* Available for download from Microchip Technology Inc.'s web site at www.microchip.com.

** Must be ordered with DVMCPA.

RFID Evaluation/Developer's Kits

	MCRF200	MCRF250	MCRF355	MCRF450/452
13.56 MHz Anti-Collision microID® Developer's Kit for MCRF355, 360, 450, 452	–	–	DV103003, DV103006	DV103006
microID® Programmer Kit only for MCRF355	–	–	PG103003	–

FUTURE MICROCHIP MICROCONTROLLER PRODUCTS

Baseline 8-Bit PICmicro® Microcontroller Family

Product	Program Memory (Bytes)	EEPROM Data Memory Bytes	RAM Bytes	I/O Pins	Packages	Analog		Digital		Max. Speed MHz	IntOSC	ICSP™	BOR/PBOR/PLVD	ICD # of Breakpoints	CCP/ECCP	nW	Other Features
						ADC Channels	Comp.	Timers/WDT	Serial I/O								
PIC12FXXX (x12): 200 ns Instruction Execution, 33 Instructions																	
PIC12F510	1536 StdFI	—	72	6	8P, 8SN, 8MS	—	1	1-8 bit, 1-WDT	—	20	8 MHz	✓	—	1**	—	—	Bandgap reference
PIC16FXXX (x12): Upwardly Compatible with PIC16C5X/PIC12CXXX, 4-12 Interrupts, 200 ns Instruction Execution, 35 Instructions, 20 mA source and 25 mA sink per I/O																	
PIC16F506	1536 StdFI	—	72	12	14P, 14SO, 14ST	—	2	1-8 bit, 1-WDT	—	20	8 MHz	✓	—	1**	—	—	Bandgap reference

** Requires ICD specific device with header module – refer to Development Tools.

Mid-Range 8-Bit PICmicro® Microcontroller Family

Product	Program Memory (Bytes)	EEPROM Data Memory Bytes	RAM Bytes	I/O Pins	Packages	Analog		Digital		Max. Speed MHz	IntOSC	BOR/PBOR/PLVD	ICD # of Breakpoints	CCP/ECCP	nW	Other Features	
						ADC Channels	Comp.	Timers/WDT	Serial I/O								
PIC16FXXX (x14): Upwardly Compatible with PIC16C5X/PIC12CXXX, 4-12 Interrupts, 200 ns Instruction Execution, 35 Instructions, ICSP™																	
PIC16F631	1792 StdFI	128	64	18	20P, 20SO, 20SS	—	2	1-16 bit, 1-8 bit, 1-WDT	—	20	8 MHz	BOR	1**	—	✓		
PIC16F639	3584 StdFI	256	128	12	20P, 20SO, 20SS	—	2	1-16 bit, 1-8 bit, 1-WDT	—	20	8 MHz	BOR	1**	—	✓	Transponder Analog Front End, KEELoq®	
PIC16F677	3584 StdFI	256	128	18	20P, 20SO, 20SS	12	2	1-16 bit, 1-8 bit, 1-WDT	—	20	8 MHz	BOR	1**	—	✓		
PIC16F685	7168 StdFI	256	256	18	20P, 20SO, 20SS	12	2	1-16 bit, 2-8 bit, 1-WDT	—	20	8 MHz	BOR	1**	0/1	✓		
PIC16F687	3584 StdFI	256	128	18	20P, 20SO, 20SS	12	2	1-16 bit, 1-8 bit, 1-WDT	EUSART, I ² C/SPI	20	8 MHz	BOR	1**	—	✓		
PIC16F689	7168 StdFI	256	256	18	20P, 20SO, 20SS	12	2	1-16 bit, 1-8 bit, 1-WDT	EUSART, I ² C/SPI	20	8 MHz	BOR	1**	—	✓		
PIC16F690	7168 StdFI	256	256	18	20P, 20SO, 20SS	12	2	1-16 bit, 1-8 bit, 1-WDT	EUSART, I ² C/SPI	20	8 MHz	BOR	1**	0/1	✓		
PIC16F785	3584 StdFI	256	128	18	20P, 20SO, 20SS	12	2	1-16 bit, 2-8 bit, 1-WDT	—	20	8 MHz	BOR	1**	1/0	✓	2 phase PWM, 2x Op Amp, VREF	
PIC16F913	7168 EnhFI	256	256	25	28P, 28SO, 28SS, 28QFN	4	1	2-8 bit, 1-16 bit	AUSART, I ² C/SPI	20	8 MHz	BOR/PLVD	1	1/0	✓	Integrated LCD control modules with 60 segments	
PIC16F914	7168 EnhFI	256	256	36	40P, 44TQFP, 44QFN	8	2	2-8 bit, 1-16 bit	AUSART, I ² C/SPI	20	8 MHz	BOR/PLVD	1	2/0	✓	Integrated LCD control modules with 96 segments	
PIC16F916	14336 EnhFI	256	352	25	28P, 28SO, 28SS, 28QFN	4	1	2-8 bit, 1-16 bit	AUSART, I ² C/SPI	20	8 MHz	BOR/PLVD	1	1/0	✓	Integrated LCD control modules with 60 segments	
PIC16F917	14336 EnhFI	256	352	36	40P, 44TQFP, 44QFN	8	2	2-8 bit, 1-16 bit	AUSART, I ² C/SPI	20	8 MHz	BOR/PLVD	1	2/0	✓	Integrated LCD control modules with 96 segments	

** Requires ICD specific device with header module – refer to Development Tools.

High Performance 8-Bit PICmicro® Microcontroller Family																	
Product	Program Memory (Bytes)	EEPROM Data Memory Bytes	RAM Bytes	I/O Pins	Packages	Analog		Digital		Max. Speed MHz	IntOSC	BOR/PBOR/PLVD		ICD # of Breakpoints	CCP/ECCP	nW	Other Features
						ADC Ch	Comp.	Timers/WDT	Serial I/O								
PIC18FXXX (x16): Upwardly Compatible with PIC17C7XX/PIC16C5X/PIC12CXXX, 77 Instructions, C Compiler Efficient Instruction Set, Software Stack Capability, Table Read/Write, Switchable Oscillator Sources, 4x PLL, 10-12 MIPS, ICSP™																	
PIC18F1230	4096 EnhFI	128	256	16	18P, 18SO, 20SS, 28ML	3x10-bit	3	2-16 bit, 1-WDT	EUSART	40	8 MHz			3	—	✓	Motor Control PWM
PIC18F1330	8192 EnhFI	128	256	16	18P, 18SO, 20SS, 28ML	3x10-bit	3	2-16 bit, 1-WDT	EUSART	40	8 MHz			3	—	✓	Motor Control PWM
PIC18F65J10	32,768 StdFI	—	2048	51	64PT	11x10-bit	2	3-16 bit, 2-8 bit, 1-WDT	2x EUSART, 2x MI ² C/SPI	40	—	✓	BOR	3	2/3	✓	PSP
PIC18F65J15	49,152 StdFI	—	2048	51	64PT	11x10-bit	2	3-16 bit, 2-8 bit, 1-WDT	2x EUSART, 2x MI ² C/SPI	40	—	✓	BOR	3	2/3	✓	PSP
PIC18F66J10	65,536 StdFI	—	2048	51	64PT	11x10-bit	2	3-16 bit, 2-8 bit, 1-WDT	2x EUSART, 2x MI ² C/SPI	40	—	✓	BOR	3	2/3	✓	PSP
PIC18F66J15	98,304 StdFI	—	3936	51	64PT	11x10-bit	2	3-16 bit, 2-8 bit, 1-WDT	2x EUSART, 2x MI ² C/SPI	40	—	✓	BOR	3	2/3	✓	PSP
PIC18F67J10	131,072 StdFI	—	3936	51	64PT	11x10-bit	2	3-16 bit, 2-8 bit, 1-WDT	2x EUSART, 2x MI ² C/SPI	40	—	✓	BOR	3	2/3	✓	PSP
PIC18F85J10	32,768 StdFI	—	2048	67	80PT	15x10-bit	2	3-16 bit, 2-8 bit, 1-WDT	2x EUSART, 2x MI ² C/SPI	40	—	✓	BOR	3	2/3	✓	PSP, EMA
PIC18F85J15	49,152 StdFI	—	2048	67	80PT	15x10-bit	2	3-16 bit, 2-8 bit, 1-WDT	2x EUSART, 2x MI ² C/SPI	40	—	✓	BOR	3	2/3	✓	PSP, EMA
PIC18F86J10	65,536 StdFI	—	3936	67	80PT	15x10-bit	2	3-16 bit, 2-8 bit, 1-WDT	2x EUSART, 2x MI ² C/SPI	40	—	✓	BOR	3	2/3	✓	PSP, EMA
PIC18F86J15	98,304 StdFI	—	3936	67	80PT	15x10-bit	2	3-16 bit, 2-8 bit, 1-WDT	2x EUSART, 2x MI ² C/SPI	40	—	✓	BOR	3	2/3	✓	PSP, EMA
PIC18F87J10	131,072 StdFI	—	3936	67	80PT	15x10-bit	2	3-16 bit, 2-8 bit, 1-WDT	2x EUSART, 2x MI ² C/SPI	40	—	✓	BOR	3	2/3	✓	PSP, EMA
PIC18F6522	32,768 EnhFI	1024	2048	54	64PT	12x10-bit	2	3-16 bit, 2-8 bit, 1-WDT	2x EUSART, 2x MI ² C/SPI	40	8 MHz	✓	PBOR	3	2/3	✓	PSP
PIC18F6527	49,152 EnhFI	1024	3936	54	64PT	12x10-bit	2	3-16 bit, 2-8 bit, 1-WDT	2x EUSART, 2x MI ² C/SPI	40	8 MHz	✓	PBOR	3	2/3	✓	PSP
PIC18F6622	65,536 EnhFI	1024	3936	54	64PT	12x10-bit	2	3-16 bit, 2-8 bit, 1-WDT	2x EUSART, 2x MI ² C/SPI	40	8 MHz	✓	PBOR	3	2/3	✓	PSP
PIC18F8522	32,768 EnhFI	1024	2048	70	80PT	16x10-bit	2	3-16 bit, 2-8 bit, 1-WDT	2x EUSART, 2x MI ² C/SPI	40	8 MHz	✓	PBOR	3	2/3	✓	PSP, EMA
PIC18F8527	49,152 EnhFI	1024	3936	70	80PT	16x10-bit	2	3-16 bit, 2-8 bit, 1-WDT	2x EUSART, 2x MI ² C/SPI	40	8 MHz	✓	PBOR	3	2/3	✓	PSP, EMA
PIC18F8622	65,536 EnhFI	1024	3936	70	80PT	16x10-bit	2	3-16 bit, 2-8 bit, 1-WDT	2x EUSART, 2x MI ² C/SPI	40	8 MHz	✓	PBOR	3	2/3	✓	PSP, EMA

Abbreviations:

CAN = Controller Area Network
 CCP = Capture/Compare/PWM
 DAC = Digital-to-Analog Converter
 E² = EEPROM
 ECAN = Enhanced Controller Area Network
 ECCP = Enhanced Capture/Compare/4-ch PWM with programmable dead time
 *Contact Microchip Technology for availability date.

ICSP = In-Circuit Serial Programming
 ICD = # of in-circuit debug breakpoints
 IntOSC = Internal Oscillator
 LVD = Low Voltage Detection
 LIN XCVR = Local Interconnection Network Transceiver
 MI²C/SPI = Master I²C/SPI

PSP = Parallel Slave Port
 PWM = Pulse Width Modulator
 PSMC = Programmable Switch Mode Controller
 ROM-less = External ROM necessary
 SLAC = Slope A/D Converter, up to 16 bits
 SMB = System Management Bus

VREF = Voltage Reference
 WDT = Watchdog Timer
 x12 = 12-bit Instruction Width
 x14 = 14-bit Instruction Width
 x16 = 16-bit Instruction Width

BATTERY MANAGEMENT FAMILY PRODUCTS

Switching Battery Chargers

Product	Mode	Cell Type	# of Cells	Vcc Range (V)	Max. Voltage Regulation (%)	In/Ext FET	Features	Package
PS200	Switch	Li-Ion/Li-Polymer	1 - 4	5 - 18	±1%	Ext	Voltage and current regulation, safety charge timers and temperature limits, internal voltage regulator, 500 kHz (max.) PWM	20-pin PDIP, SOIC, SSOP

For Linear Battery Chargers, refer to Analog/Interface Family Products.

Battery Fuel Gauge ICs

Product	Battery Chemistry	# of Cells	Interface	Data Set	A/D Converter	Programmable Memory	Programmable I/O Functions	Accuracy	Time Base	Safety	Temp. Sensor	Packaging	Description
PS810	Li-Ion	1-Jan	SMBus/SI		16-bit Sigma-Delta	4k x 16 Flash	6 GPIO	1%	On-chip	—	On-chip	14-pin TSSOP, 16-pin QFN	Single cell Li-Ion fuel gauge provides battery status such as run time-to-empty, run time-to-full, relative state-of-charge and battery state-of-health.
PS830	Li-Ion	1-Jan	SMBus/SI		16-bit Sigma-Delta	4k x 16 Flash	3 GPIO	1%	On-chip	Internal	On-chip	14-pin TSSOP, 16-pin QFN	Single cell Li-Ion fuel gauge w/ integrated safety provides battery status such as run time-to-empty, run time-to-full, relative state-of-charge and battery state-of-health

dsPIC® DIGITAL SIGNAL CONTROLLER (DSC) PRODUCTS

Product	Program (FLASH) KBytes	Memory (FLASH) KWords	EE Bytes	SRAM Bytes	Packages	A/D 12-bit 100 KSPS	A/D 10-bit 500 KSPS	Timer 16-bit	Input Cap	Output Comp/Std PWM	Motor Control PWM	Quad Enc.	UART	SPI™	I ² C™	CAN	Codec Interface
dsPIC30F Motor Control and Power Conversion Family																	
dsPIC30F3010	24	8	1024	1024	28SOG, 28SPG	—	6 ch	5	4	2	6	✓	1	1	1	—	—
dsPIC30F3011	24	8	1024	1024	40PG, 44PTG	—	9 ch	5	4	4	6	✓	2	1	1	—	—
dsPIC30F5015	66	22	1024	2048	64PTG	—	16 ch	5	4	4	8	✓	1	2	1	1	—

*Contact Microchip Technology for availability date.

SERIAL ELECTRICALLY ERASABLE PROMS (EEPROM)

Part #	E/W Cycles	Density (Organization)	Page Size	Write Speed	Max. Clock Freq.	Operating Voltage (V)	Temps	Unique Features	Packages ^(Note)
SPI™ Compatible Serial EEPROM Family – Page Write mode, HOLD pin, software enabled block write protection and hardware write-protect pin									
25LC010A	1M	1 Kbit (x8)	16B	5 ms	10 MHz	2.5 to 5.5	I, E		P, SN, ST, MS
25AA010A	1M	1 Kbit (x8)	16B	5 ms	10 MHz	1.8 to 5.5	I		P, SN, ST, MS
25LC020A	1M	2 Kbit (x8)	16B	5 ms	10 MHz	2.5 to 5.5	I, E		P, SN, ST, MS
25AA020A	1M	2 Kbit (x8)	16B	5 ms	10 MHz	1.8 to 5.5	I		P, SN, ST, MS
25LC040A	1M	4 Kbit (x8)	16B	5 ms	10 MHz	2.5 to 5.5	I, E		P, SN, ST, MS
25AA040A	1M	4 Kbit (x8)	16B	5 ms	10 MHz	1.8 to 5.5	I		P, SN, ST, MS
25LC320A	1M	32 Kbits (x8)	32B	5 ms	10 MHz	2.5 to 5.5	I, E		P, SN, ST, MS
25AA320A	1M	32 Kbits (x8)	32B	5 ms	10 MHz	1.8 to 5.5	I, E		P, SN, ST, MS
25LC640A	1M	64 Kbits (x8)	32B	5 ms	10 MHz	2.5 to 5.5	I, E		P, SN, ST, MS
25AA640A	1M	64 Kbits (x8)	32B	5 ms	10 MHz	1.8 to 5.5	I		P, SN, ST, MS
25LC128	1M	128 Kbits (x8)	64B	5 ms	10 MHz	2.5 to 5.5	I, E		P, SN, ST, MS
25AA128	1M	128 Kbits (x8)	64B	5 ms	10 MHz	1.8 to 5.5	I		P, SN, ST, MS
25LC256	1M	256 Kbits (x8)	64B	5 ms	10 MHz	2.5 to 5.5	I, E		P, SN, ST, MF
25AA256	1M	256 Kbits (x8)	64B	5 ms	10 MHz	1.8 to 5.5	I		P, SN, ST, MF
25LC1024	1M	1 Mbit (x8)	256B	5 ms	20 MHz	2.5 to 5.5	I, E		P, SM, MF
25AA1024	1M	1 Mbit (x8)	256B	5 ms	20 MHz	1.8 to 5.5	I		P, SM, MF

NOTE: Pb-free packages will be available. Order with "G" suffix. Example: 25LC040A-I/SNG.

ANALOG/INTERFACE PRODUCTS

Part #	Typical Accuracy (°C)	Maximum Accuracy @ 25°C (°C)	Maximum Temperature Range (°C)	Vcc Range (V)	Max. Supply Current (µA)	Features	Packages
Thermal Management - Voltage Output Temperature Sensors							
MCP9700	±2	±4	-40 to +125	+2.3 to +5.5	12	Temperature slope: 10 mV/°C	5-pin SC-70
MCP9700A	±1	±2	-40 to +125	+2.3 to +5.5	12	Temperature slope: 10 mV/°C	5-pin SC-70
MCP9701	±2	±4	-10 to +125	+3.1 to +5.5	12	Temperature slope: 19.53 mV/°C, cross to MAX6612	5-pin SC-70
MCP9701A	±1	±2	-10 to +125	+3.1 to +5.5	12	Temperature slope: 19.53 mV/°C, cross to MAX6612	5-pin SC-70

Power Management – Switching Regulators										
Part #	Description	Input Voltage Range (V)	Output Voltage Range (V)	Operating Temperature Range (°C)	Control Scheme	Switching Frequency (kHz)	Typical Active Current (mA)	Output Current (mA)	Features	Packages
MCP1612	Synchronous Buck DC/DC Regulator	2.7 to 5.5	0.8 to 5.5	-40 to +85	Constant frequency PWM	1400	10	1000	Overall efficiency >94% soft start, over-temperature and over-current protection	8-Pin MSOP, 8-Pin 3x3 DFN
MCP1614	Dual Synchronous Buck DC-DC converter	2.7 to 5.5	0.8 to 5.5	-40 to +85	Constant frequency PWM	1400	18	1000/1000	Overall efficiency > 94%, soft start, over-temperature and over current protection	16-Pin QSOP

Power Management - Battery Chargers								
Part #	Mode	Cell Type	# of Cells	Vcc Range (V)	Max. Voltage Regulation (%)	Int/Ext FET	Features	Packages
MCP73853	Linear	Li-Ion/Li-Polymer	1	4.5 to 5.5	±0.5	Int	USB control, safety charge timers, temperature monitor, thermal regulation	16-Pin QFN (4x4)
MCP73855	Linear	Li-Ion/Li-Polymer	1	4.5 to 5.5	±0.5	Int	USB control, safety charge timers, thermal regulation	10-Pin DFN (3x3)

Linear – Operational Amplifiers								
Part #	Channels	GBWP	I _Q Typ.	V _{OS}	Operating Voltage (V)	Temperature Range (°C)	Features	Packages
MCP6234	4	300 kHz	20 µA	7 mV	1.8 to 5.5	-40° to +125	Rail-to-Rail Input/Output	14-Pin PDIP, 14-Pin SOIC, 14-Pin TSSOP
MCP6244	4	650 kHz	50 µA	7 mV	1.8 to 5.5	-40° to +125	Rail-to-Rail Input/Output	14-Pin PDIP, 14-Pin SOIC, 14-Pin TSSOP

Linear – Linear Gain Blocks								
Part #	Channels	-3dB BW (kHz)	I _Q (µA)	V _{OS} (mV)	Operating Voltage (V)	Temperature Range (°C)	Gain Steps (V/V)	Packages
MCP6G01	1	1	120	3	1.8 to 5.5	-40 to +125	1, 10, 50	8-Pin PDIP, 8-Pin SOIC, 8-Pin TSSOP
MCP6G02	2	1	120	3	1.8 to 5.5	-40 to +125	1, 10, 50	8-Pin PDIP, 8-Pin SOIC, 8-Pin TSSOP
MCP6G04	4	1	120	3	1.8 to 5.5	-40 to +125	1, 10, 50	14-Pin PDIP, 14-Pin SOIC, 14-Pin TSSOP
MCP6G41	1	14 to 100	2	3	1.8 to 5.5	-40 to +125	1, 10, 50	8-Pin PDIP, 8-Pin SOIC, 8-Pin MSOP
MCP6G42	2	14 to 100	2	3	1.8 to 5.5	-40 to +125	1, 10, 50	8-Pin PDIP, 8-Pin SOIC, 8-Pin MSOP
MCP6G44	4	14 to 100	2	3	1.8 to 5.5	-40 to +125	1, 10, 50	14-Pin PDIP, 14-Pin SOIC, 14-Pin TSSOP

Mixed Signal - Delta-Sigma A/D Converters							
Part #	Resolution (bits)	Maximum Sampling Rate (samples/sec)	# Input Channels	Interface	Typical Supply Current (μA)	Supply Voltage Range (V)	Packages
MCP3551	22	15	1	SPI™	150	2.7 to 5.5	8-Pin PDIP, 8-Pin SOIC, 8-Pin MSOP

Interface – Infrared Products						
Part #	Operating Voltage (V)	Temperature Range (°C)	Max Baud Rate	Unique Features	Packages	
MCP2130	2.7 to 5.5	-40 to +85	16x less than clock input	IrDA encoder/decoder plus transceiver processing. No external IrDA transceiver required.	14-Pin PDIP, 14-Pin SOIC, 10-Pin MSOP	

FUTURE

PIN AND CODE COMPATIBILITY CHART

8-pin PICmicro® MCU Family

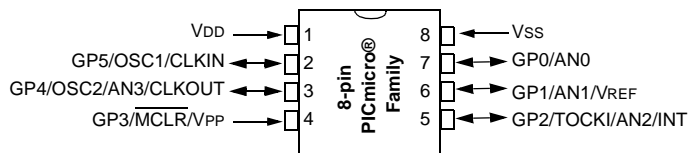

PIC12C508A	PIC12C671	PIC12F509
PIC12C509A	PIC12C672	PIC12F629
PIC12CR509A	PIC12CE673	PIC12F635
PIC12CE518	PIC12CE674	PIC12F675
PIC12CE519	PIC12F508	PIC12F683

8-pin KEELoQ® Family

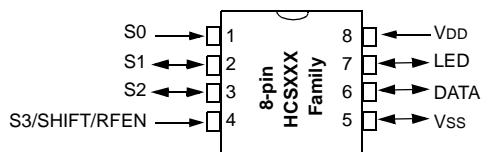

HCS101	HCS300	HCS360
HCS200	HCS301	HCS361
HCS201	HCS320	HCS362
		HCS365

18-pin PICmicro® MCU Family

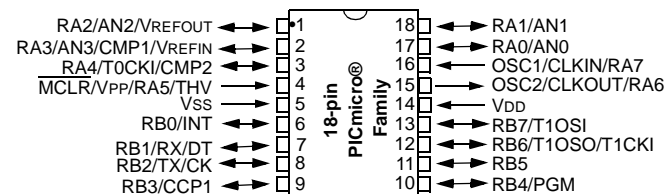

PIC16C620A	PIC16CE625	PIC16C710	PIC16F84A
PIC16CR620A	PIC16F627	PIC16C711	PIC16F818
PIC16C621A	PIC16F628	PIC16C712	PIC16F819
PIC16C622A	PIC16F627A	PIC16C715	PIC16F87
PIC16CE623	PIC16F628A	PIC16C716	PIC16F88
PIC16CE624	PIC16F648A	PIC16F716	PIC16F54
PIC16C54C	PIC16C56A	PIC16C58B	PIC16HV540

8/14/20-pin PICmicro® MCU Family

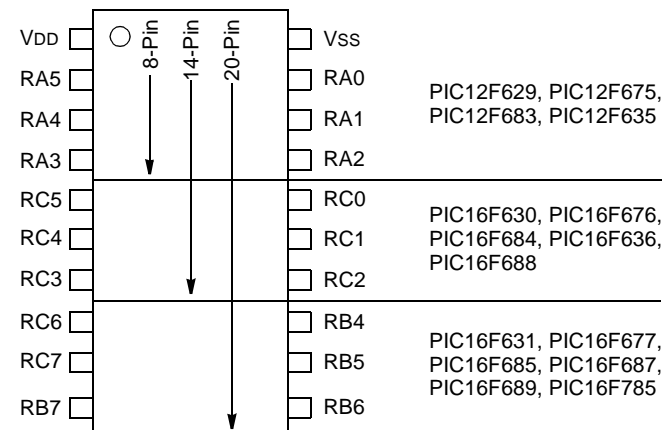

PIC12F629, PIC12F675,
PIC12F683, PIC12F635

PIC16F630, PIC16F676,
PIC16F684, PIC16F636,
PIC16F688

PIC16F631, PIC16F677,
PIC16F685, PIC16F687,
PIC16F689, PIC16F785

28-pin PICmicro® MCU Family

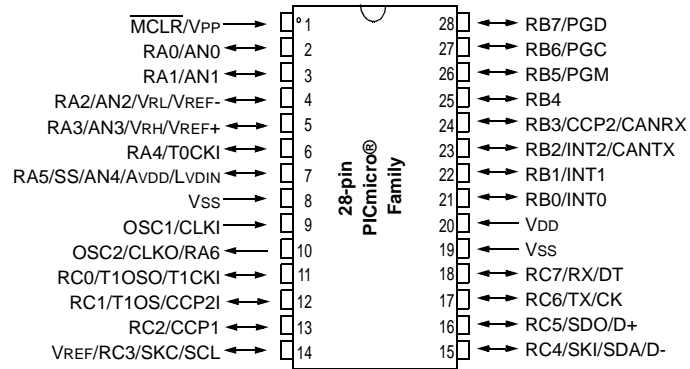

PIC16C62B	PIC16F72	PIC18C242
PIC16CR63	PIC16F73	PIC18C252
PIC16C63A	PIC16F737	PIC18F242
PIC16C642	PIC16F76	PIC18F248
PIC16C66	PIC16F767	PIC18F252
PIC16CR72	PIC16F870	PIC18F258
PIC16C72A	PIC16F872	PIC18F2220
PIC16C73B	PIC16F873	PIC18F2320
PIC16C745	PIC16F873A	PIC18F2455
PIC16C76	PIC16F876	PIC18F2525
PIC16C773	PIC16F876A	PIC18F2550
		PIC18F2620

40-pin PICmicro® MCU Family

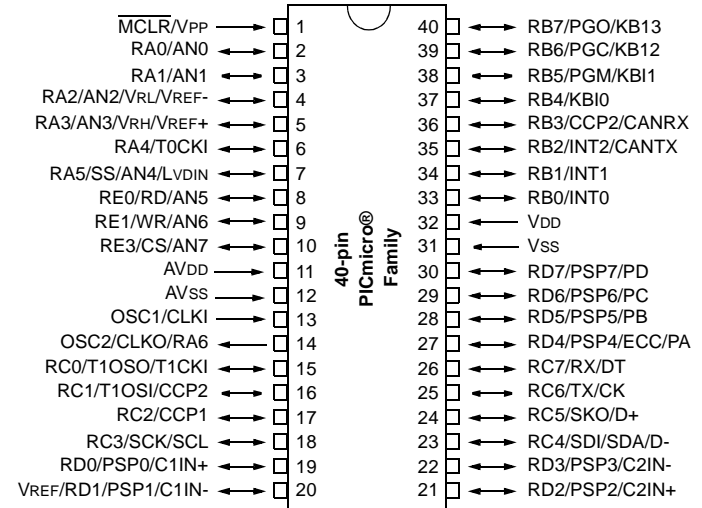

PIC16CR65	PIC16F77	PIC18F448
PIC16C65B	PIC16F777	PIC18F452
PIC16C662	PIC16F871	PIC18F458
PIC16C67	PIC16F874	PIC18F4220
PIC16C74B	PIC16F874A	PIC18F4320
PIC16C765	PIC16F877	PIC18F4455
PIC16C77	PIC16F877A	PIC18F4525
PIC16C774	PIC18C442	PIC18F4550
PIC16F74	PIC18C452	PIC18F4620
PIC16F747	PIC18F442	

64-pin PICmicro® MCU Family

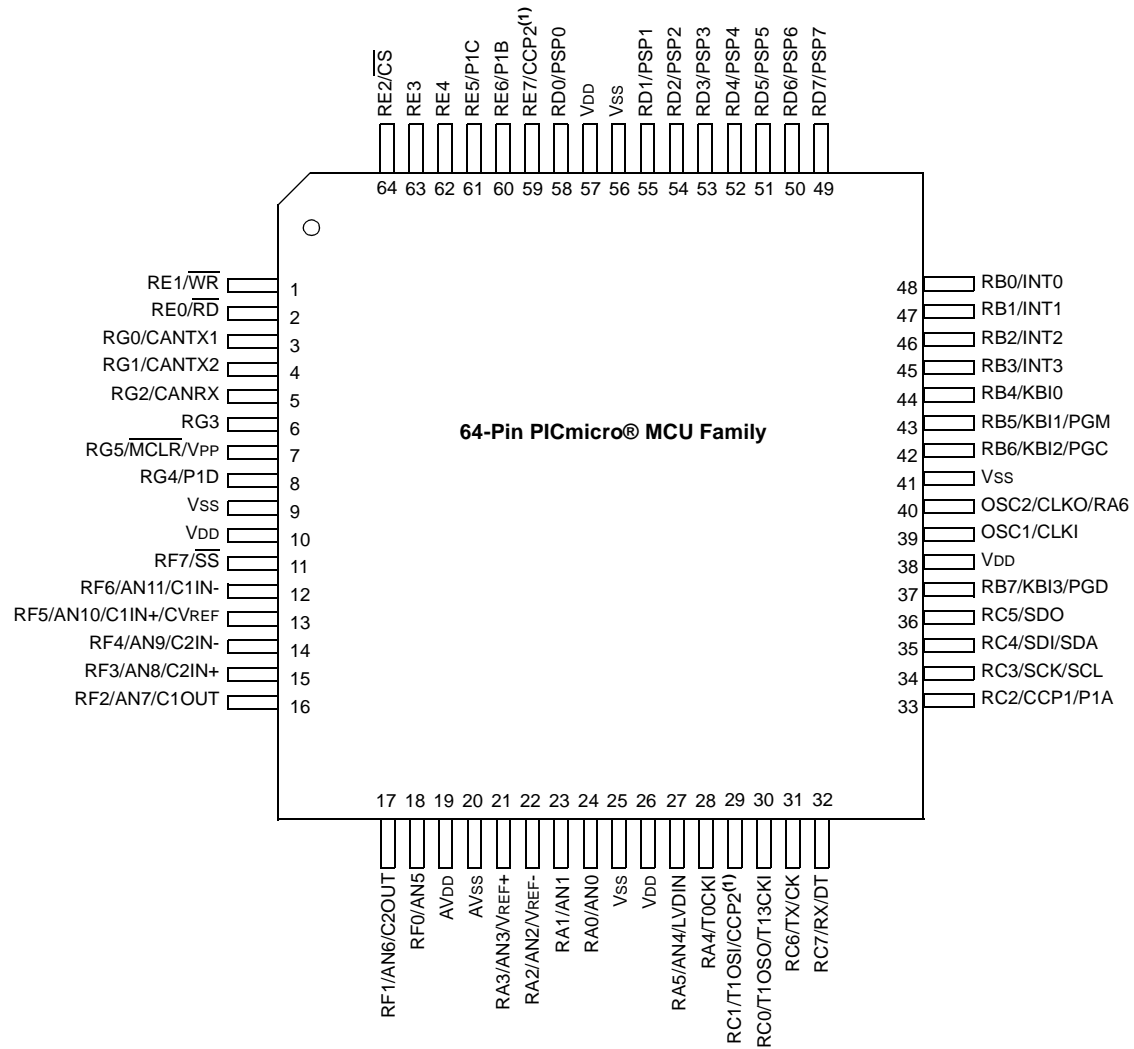

Note 1: CCP2 pin placement depends on CCP2MX setting.

PIC18F6310	PIC18F6525	PIC18F6621
PIC18F6410	PIC18F6585	PIC18F6680
PIC18F6520	PIC18F6620	PIC18F6720

80-pin PICmicro® MCU Family

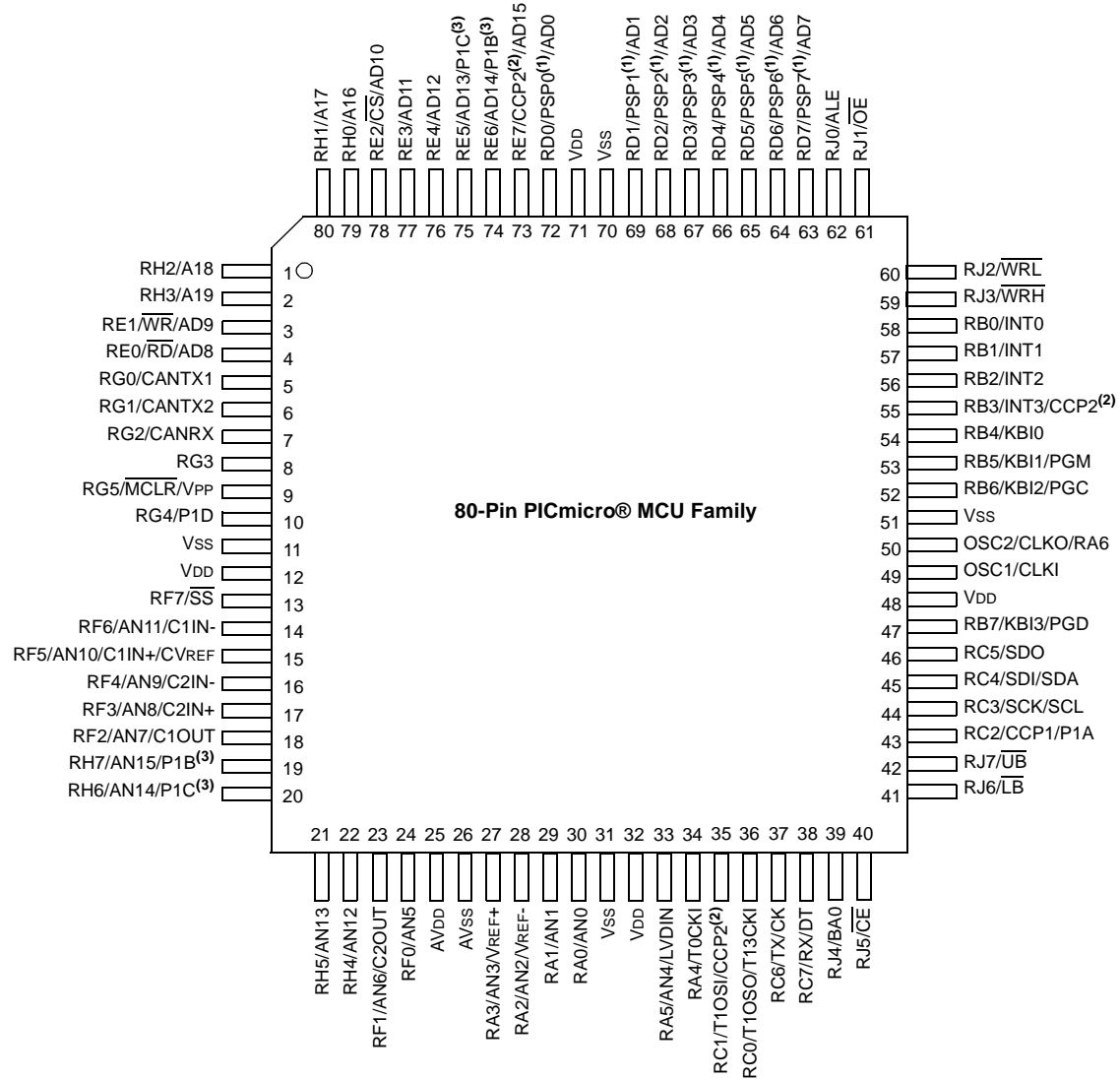

- Note 1:** PSP is available only in Microcontroller mode.
- 2:** CCP2 pin placement depends on CCP2MX and Processor mode settings.
- 3:** P1B and P1C pin placement depends on ECCPMX setting.

**CERAMIC DUAL IN-LINE
CERDIP**



18-LEAD CERDIP
"JW"



20-LEAD CERDIP
"JW"



28-LEAD CERDIP
"JW"

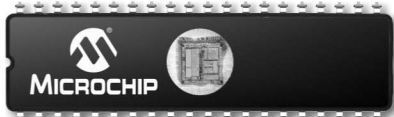

40-LEAD CERDIP
"JW"

**CERAMIC CHIP CARRIER
CERQUAD**



68-LEAD CERQUAD
"CL"



84-LEAD CERQUAD
"CL"

**PLASTIC DUAL IN-LINE
PDIP**



8-LEAD PDIP
"P" OR "PA"



14-LEAD PDIP
"P" OR "PD"



18-LEAD PDIP
"P"



20-LEAD PDIP
"P"



24-LEAD PDIP
"P" OR "PG"

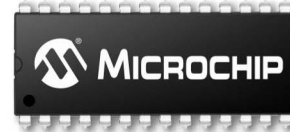

28-LEAD PDIP
"P" OR "PI"



28-LEAD SKINNY PDIP
"SP" OR "PJ"



40-LEAD PDIP
"P" OR "PL"

**PLASTIC QUAD
FLATPACK
"QFP"**



32-LEAD LQFP
"LQ"



44-LEAD MQFP
"PQ"

**PLASTIC LEADED
CHIP CARRIER
PLCC**



32-LEAD PLCC
"L"



44-LEAD PLCC
"L" OR "W"



68-LEAD PLCC
"L" OR "LS"



84-LEAD PLCC
"L"

PACKAGES ARE APPROXIMATE SIZE

**Pin Count/
Packaging**

**PLASTIC SMALL OUTLINE
"SOIC"**

8-LEAD SOIC
(.150") "SN" OR "OA"

8-LEAD SOIC
(.208") "SM"

14-LEAD SOIC
(.150") "SL" OR "OD"

28-LEAD SOIC
"SO" OR "OI"

16-LEAD SOIC
(.150") "SL"

18-LEAD SOIC
"SO"

20-LEAD SOIC
"SO"

**PLASTIC SHRINK
SMALL OUTLINE
"SSOP"**

 
20-LEAD SSOP "SS" 28-LEAD SSOP
"SS"

16-LEAD QSOP

8-LEAD MSOP
"MS" OR "UA"

10-LEAD MSOP
"UN"

**PLASTIC THIN QUAD
FLATPACK
"TQFP"**

44-LEAD TQFP
"PT"

64-LEAD TQFP
"PT"

80-LEAD "TQFP"
"PT"

80-LEAD "TQFP"
"PF"

**SIDE BRAZED
DUAL-IN-LINE
"JW"**

8-LEAD SIDE BRAZED
"JW"

14-LEAD SIDE BRAZED
"JW"

20-LEAD SIDE BRAZED
"JW"

28-LEAD SIDE BRAZED
(.300") "JW"

**PLASTIC THIN SHRINK
SMALL OUTLINE
"TSOP"**

8-LEAD TSSOP
(4.4MM) "ST"



14-LEAD TSSOP
(4.4MM) "ST" (PICmicro MCU)
(4.4MM) "ST14" (Memory)

20-LEAD TSSOP
(4.4MM) "ST"

8-LEAD DFN
3X3
"MF"

8-LEAD DFN
6X5
"MF"

44-LEAD QFN
8X8
"ML"

16-LEAD QFN
4X4
"ML"

28-LEAD QFN
6X6
"ML" or "MM"

**CHIP SCALE
PACKAGES**

3-LEAD DPAK

5-LEAD DPAK

SMALL OUTLINE TRANSISTOR

3-LEAD TRANSISTOR
"TO" OR "ZB"

3-LEAD SC-89

SOT-223

6-LEAD SOT-23

3-LEAD SOT-23

SOT-143

5-LEAD TO-220

5-LEAD SOT-23



5-LEAD SC-70

3-LEAD SC-70

Part Number Suffix Designations

Ordering Information for all Microchip PICmicro®, KEELoq®, RFID, rFHCS and Memory Products

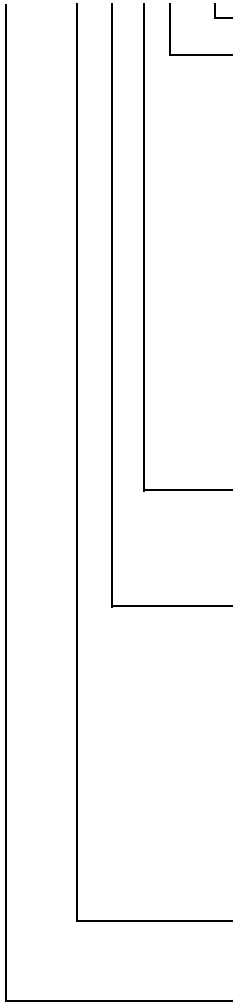
XXXXXXXXXX - XX XXX XXX



QTP, SQTP or ROM Code; Special Requirements

Package:

- | | |
|--|---|
| 1M = 1000pF COB Module, .75mm | S = Die in Waffle Pack |
| 3M = 330pF COB Module, .45mm | SB = Bumped Die in Waffle Pack |
| 6C = 2x68pF COB Module (WORLD II) | SL = 14-lead Small Outline (150 mil) |
| 7M = 2x68pF COB Module (IOA2) | SM = 8-lead Small Outline (207 mil) |
| CB = Chip on Board (COB) | SN = 8-lead Small Outline (150 mil) |
| CL = Windowed CERQUAD | SO = Plastic Small Outline (SOIC) (300 mil) |
| G = Lead Free | SP = Plastic Skinny DIP |
| JW = Windowed CERDIP | SS = Plastic Shrink Small Outline (SSOP) |
| L = Plastic Leaded Chip Carrier (PLCC) | ST = Thin Shrink Small Outline (TSSOP 4.4 mm) |
| LQ = Plastic Low Quad Flatpack (LQFP) | ST14 = 14-lead Thin Shrink Small Outline (TSSOP-14) |
| MF = Dual Flat - No Leads (DFN) | TO-92 = Transistor Outline |
| ML = Quad Flat - No Leads (QFN) | TS = Thin Small Outline (8mm x 20mm) |
| MM = Quad Flat - No Leads (DFN) | TT = SOT-23-3 Small Outline Transistor |
| MS = Micro Small Outline (MSOP) | VS = Very Small Outline (8mm x 12mm) |
| OT = 5-Lead or 6-Lead SOT-23 | W = Uncut Wafer |
| P = Plastic DIP | WB = Bumped Wafer |
| PF = Plastic Thin Quad Flatpack (TQFP 14x14) | WF = Sawed Wafer on Frame |
| PQ = Plastic Quad Flatpack (PQFP) | WFB = Bumped, Sawed Wafer on Frame |
| PT = Plastic Thin Quad Flatpack (TQFP) | WM = SOT385 Leadless Module |

Process Temperature:

- Blank = 0°C to +70°C
 I (Industrial) = -40°C to +85°C
 E (Extended) = -40°C to +125°C

Speed: OR

- 90 = 90 ns
 -10 = 100 ns
 -12 = 120 ns
 -15 = 150 ns
 -17 = 170 ns
 -20 = 200 ns or 20 MIPS
 -25 = 250 ns or 30 MIPS
 -30 = 300 ns

Crystal Frequency Designator for PICmicro® MCUs

- LP = DC to 40 kHz, Low Power Crystal Oscillator
 RC = DC to 4 MHz, Resistor/Capacitor Oscillator
 XT = DC to 4 MHz, Standard Crystal Resonator Oscillator
 HS = DC to 20 MHz, High Speed Crystal Oscillator
 02 = DC to 2 MHz, XT and RC Oscillator Support
 04 = DC to 4 MHz Internal, XT and RC Oscillator Support
 04 = DC to 200 kHz, LP Oscillator Support
 08 = DC to 8 MHz, HS Oscillator Support
 10 = DC to 10 MHz, HS Oscillator Support
 16 = DC to 16 MHz, XT Oscillator Support
 20 = DC to 20 MHz, HS Oscillator Support
 25 = DC to 25 MHz, XT Oscillator Support
 30 = DC to 30 MHz, HS Oscillator Support
 33 = DC to 33 MHz, XT Oscillator Support
 40 = DC to 40 MHz, HS Oscillator Support

Option:

- T = Tape and Reel Shipments
 X = Rotated pinout

Device Type: (Up to 10 digits)

- | | |
|---------------------------------------|---|
| AA = 1.8V Serial EEPROM | LCE = Low Voltage CMOS EPROM/EEPROM MCU |
| C = CMOS EPROM/ROMless MCU | LCR = Low Voltage CMOS ROM MCU |
| C = 5V Serial EEPROM | LCS = Low Voltage Security |
| CE = CMOS EPROM/EEPROM MCU | LF = Low Voltage FLASH MCU |
| CR = CMOS ROM MCU | LV = Low Voltage |
| F = Flash MCU | 24 = 2-Wire (I ² C) |
| FC = High Speed serial EEPROM | 25 = SPI |
| HC = High Speed | 93 = 3-Wire (Microwire) |
| HV = High Voltage | |
| LC = Low Voltage CMOS EPROM MCU | |
| LC = Low Voltage (2.5V) Serial EEPROM | |

Note: Microchip offers a wide variety of lead-free package options. Contact your local sales office for availability or refer to the list on Microchip's web site. Lead-free plating is denoted by a "G" at the end of the package designation.

Pin Count/
Packaging

Part Number Suffix Designations

Ordering Information for all Microchip Analog Products beginning with "TC" (formerly TelCom Semiconductor Products)

TC 7106 A-60 1 C P L 713

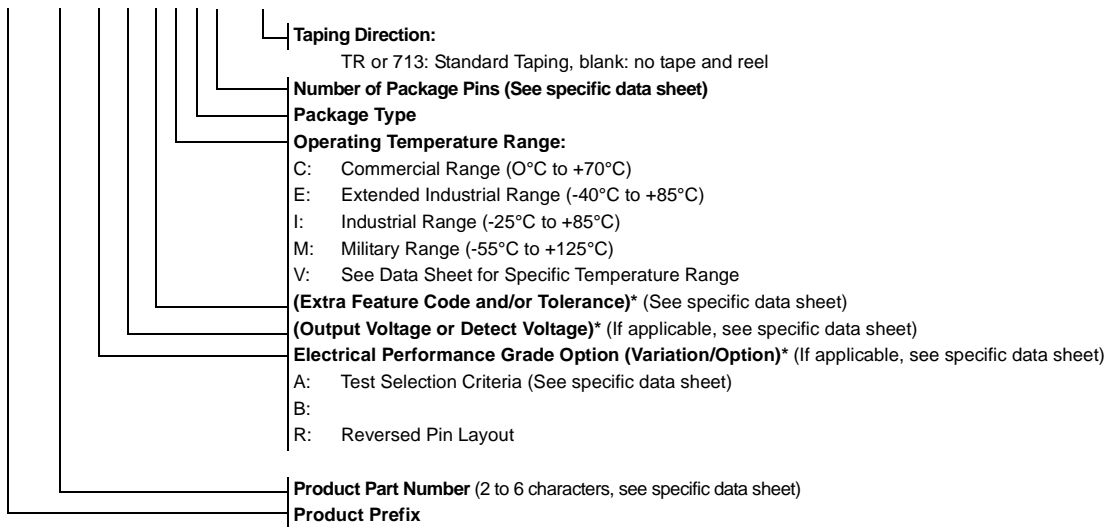

NOTE: () * Used for voltage regulators and detectors.

Package	Description	# of Pins
AB	TO-220	3
AK	TO-220	7
AT	TO-220	5
AV	TO-220 (Formed)	5
BB	TO-220B	3
CB	SOT-23A	3
CH	SOT-23A	6
CT	SOT-23A	5
DB	SOT-223	3
EB	DDPAK	3
EK	DDPAK	7
ET	DDPAK	5
HA	SOP	8
JA	CDIP (N)	8
JD	CDIP (N)	14
JE	CDIP (N)	16
JG	CDIP (W)	24
JI	CDIP (W)	28
JL	CDIP (W)	40
KU	MQFP	64
KW	MQFP	44
LB	SC-70	3
LI	PLCC	28
LS	PLCC	68
LT	SC-70	5
LW	PLCC	44

Package	Description	# of Pins
MB	SOT-89	3
MF	DFN (3x3)	8
MT	SOT-89	5
NB	SOT-23B	3
OA	SOIC (N)	8
OD	SOIC (N)	14
OE	SOIC (W)	16
OG	SOIC (W)	24
OI	SOIC (W)	28
OR	SOIC (N)	16
PA	PDIP (N)	8
PD	PDIP (N)	14
PE	PDIP (N)	16
PF	PDIP (N)	24
PG	PDIP (W)	24
PI	PDIP (W)	28
PJ	PDIP (W)	28
PL	PDIP (W)	40
QR	QSOP (N)	16
RC	SOT-143	4
SI	SSOP (W)	28
UA	MSOP	8
UN	MSOP	10
VB	DDPAK	3
ZB	TO-92	3
ZM	TO-92	2

Pin Count/
Packaging

Part Number Suffix Designations

Ordering Information for all Microchip Analog Products beginning with "MCP" Prefix Parts

MCP xxxxx T - yyy z h / qq

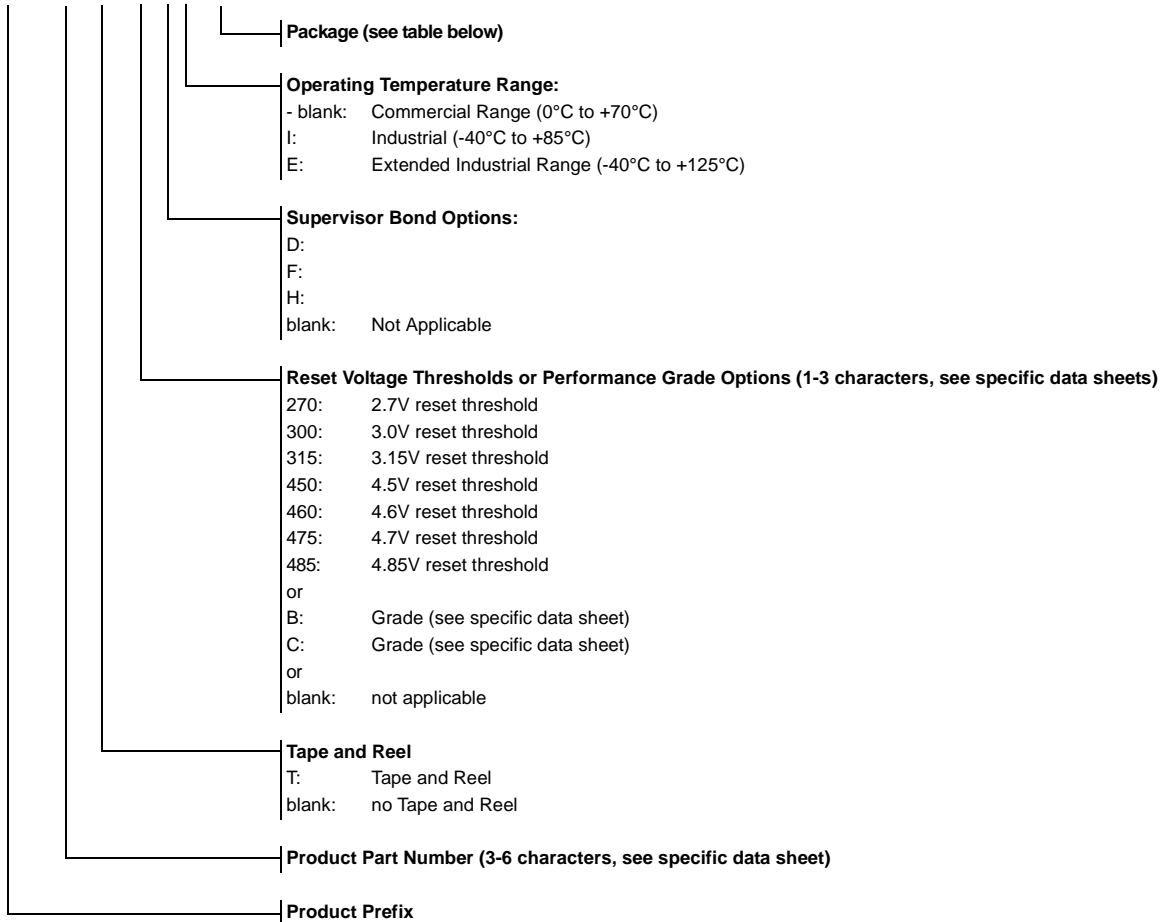

Package	Description	# of Pins	Tube/Bag Qty.	Reel Qty.
TO	TO-92	3	1000	n/a
TT	SOT-23	3	n/a	3000
OT	SOT-23	5	n/a	3000
P	PDIP	8	60	n/a
SN	SOIC	8	100	3300
ST	TSSOP	8	100	2500
MS	MSOP	8	100	2500
MF	DFN (3x3)	8	50	3300
ST	TSSOP	14	96	2500
P	PDIP	14	30	n/a
SL	SOIC	14	57	2600
P	PDIP	18	25	n/a
SO	SOIC	18	42	1100
ST	TSSOP	20	74	2500
SS	SSOP	20	67	1600
ML	QFN (6x6)	28	50	1600
ML	QFN (4x4)	16	91	3300

Pin Count/
Packaging

ABBREVIATIONS	
ADC	Analog-to-Digital Converter
ASK	Amplitude Shift Key
AUSART	Addressable USART (RS-232, RS-485)
BOR	Brown-Out Detection/Reset
CAN	Controller Area Network
CAP	Capture
CCP	Capture/Compare/PWM
CRC	Cyclic Redundancy Check
DAC	Digital-to-Analog Converter
3 ϕ	3 Phase PWMs
4 ϕ	4 Phase PWMs
E2	EEPROM (Reprogrammable)
ECAN	Enhanced Controller Area Network
ECCP	Enhanced Capture/Compare/4-ch PWM with program dead time
EMA	External Memory Addressing
EnhFI	Enhanced Flash
EUSART	Enhanced USART (RS232, RS485, LIN)
FSK	Frequency Shift Key
I ² C	Inter-integrated Circuit Bus
ICSP	In-Circuit Serial Programming
ICD	# of In-Circuit Debug Breakpoints
IntOSC	Internal Oscillator
LNA	Low Noise Amplifier
LVD	Low Voltage Detection
LIN XCVR	Local Interconnection Network Transceiver
MI ² C/SPI	Master I ² C/SPI
nW	nanoWatt
OTP	One-Time Programmable
PBOR	Programmable Brown-Out Detection/Reset
PLVD	Programmable Low-Voltage Detection
PSMC	Programmable Switch Mode Controller
PSP	Parallel Slave Port
PSMC	Programmable Switch Mode Controller
PWM	Pulse Width Modulator
ROM-less	External ROM necessary
RSSI	Received Signal Strength Indicator
SLAC	Slope A/D Converter, up to 16 bits
SMB	System Management Bus
SPI	Serial Peripheral Interface
StdFI	Standard Flash
ULPW	Ultra Low Power Wake-up
USART	Universal Synchronous/Asynchronous Receiver/Transmitter
USB	Universal Serial Bus
VREF	Voltage Reference
WDT	Watchdog Timer
✓P	Programmable
x12	12-bit Instruction Width
x14	14-bit Instruction Width
x16	16-bit Instruction Width

Microchip Technology's Quality Policy

In order to meet or exceed customer expectations at a reduced cost, we encourage our employees to support continuous improvement, anticipate problems and implement root cause solutions.

Aggregate Approach

Microchip has instituted an "aggregate" approach to understand, align, integrate and unite all company resources. Microchip consciously designed the enterprise as an aggregate system in which company culture, systems, practices, policies and employees work in unison to achieve Microchip's mission and goals. This aggregate system and culture is taught in the Microchip Culture class required for all new hires and taught by Executive Staff members.

The Quality Culture of Microchip is that every organization, business unit and individual owns the quality of their output, whether it is product, process, software or service.

A company must aggressively pursue continuous improvement, employee development, team deployment and statistical techniques to successfully achieve individual accountability of quality.

Continuous Improvement

Microchip promotes a culture of continuous improvement. As stated above, each employee is measured on how they contribute to improvement. Continuous improvement teams are constantly looking to solve problems, allowing us to maximize our value to our customers.

Employee Development and Team Deployment

Every employee has access to a full suite of training. Each employee is measured on Quality and Quantity of work, Teamwork, Continuous Improvement and Customer Satisfaction. Supervisors are measured on how their employees improve and learn. Employees have regular One-on-Ones with their supervisors and open door is a policy that is really practiced.

Statistical Techniques

Microchip uses statistical process techniques in all aspects of our business. Decision-making, experiment definition and process control are a few areas where these techniques are applied. Every manufacturing employee is trained in SPC before they start their job, since they are the people closest to the product quality.

QS-9000 Certification

Microchip Technology's Quality System is based on QS-9000 requirements. QS-9000 is rapidly becoming the standard Quality System for many industries including Semiconductors. All Microchip product facilities and major subcontractors are QS registered. Development Systems and Mountain View products are designed, manufactured and certified to ISO-9001 requirements.

Quality Systems and Reliability Information

Visit www.microchip.com for detailed Quality Systems and Reliability information.

Microchip's Quality System is fully described in the *Microchip Overview, Quality Systems and Customer Interface Systems Handbook* (DS00169) available on our web site.

Sales Listing

AMERICAS

Atlanta	770-640-0034
Boston	978-692-3848
Chicago	630-285-0071
Dallas	972-818-7423
Detroit	248-538-2250
Kokomo	765-864-8360
Los Angeles	949-263-1888
San Jose	650-215-1444
Toronto	905-673-0699

ASIA/PACIFIC

Australia	61-2-9868-6733
China – Beijing	86-10-8528-2100
China – Chengdu	86-28-8676-6200
China – Fuzhou	86-591-7503506
China – Hong Kong	852-2401-1200
China – Shanghai	86-21-6275-5700
China – Shenzhen	86-755-8290-1380
China – Shunde	86-757-28395507
China – Qingdao	86-532-5027355
India	91-80-22290061
Japan	81-45-471-6166
Korea	82-2-554-7200
Singapore	65-6334-8870
Taiwan – Taipei	886-2-2717-7175
Taiwan – Kaohsiung	886-7-536-4818

EUROPE

Austria	43-7242-2244-399
Denmark	45-4420-9895
France	33-1-69-53-63-20
Germany	49-89-627-144-0
Italy	39-0331-742611
Netherlands	31-416-690399
United Kingdom	44-118-921-5869



MICROCHIP
www.microchip.com

2355 West Chandler Boulevard • Chandler, Arizona 85224-6199 • (480) 792-7200 • Fax (480) 792-7277

Information subject to change. The Microchip name and logo, the Microchip logo, Accuron, dsPIC, Keeloq, microID, MPLAB, PIC, PICmicro, PICSTART, PRO MATE, PowerSmart, rPIC, and SmartShunt are registered trademarks of Microchip Technology Incorporated in the U.S.A. and other countries. AmpLab, FilterLab, MXDEV, MXLAB, PICMASTER, SEEVAL, SmartSensor and The Embedded Control Solutions are registered trademarks of Microchip Technology Incorporated in the U.S.A. Application Maestro, dsPICDEM, dsPICDEM.net, dsPICworks, ECAN, ECONOMONITOR, FanSense, FlexROM, fuzzyLAB, In-Circuit Serial Programming, ICSP ICEPIC, Migratable Memory, MPASM, MPLIB, MPLINK, MPSIM, PICkit, PICDEM, PICDEM.net, PICLAB, PICtail, PowerCal, PowerInfo, PowerMate, PowerTool, rLab, Select Mode, Smart Serial, SmartTel and Total Endurance are trademarks of Microchip Technology Incorporated in the U.S.A. and other countries.

SQTP is a service mark of Microchip Technology Incorporated in the U.S.A.

All other trademarks mentioned herein are property of their respective companies.

©2004 Microchip Technology Inc. All rights reserved. Printed in the U.S.A. 10/04 DS00148J4