

BCM™ Bus Converter

- 48 V to 24 V V•I Chip™ Bus Converter
- 300 Watt (450 Watt for 1 ms)
- High density – 1017 W/in³
- Small footprint – 260 W/in²
- Low weight – 0.5 oz (15 g)
- ZVS / ZCS isolated Sine Amplitude Converter™
- Typical efficiency 96%
- 125°C operation (T_j)
- <1 μs transient response
- 3.5 million hours MTBF
- No output filtering required

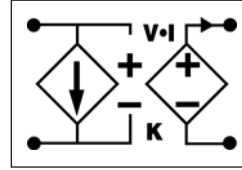

V_{IN} = 38 - 53 V
V_{OUT} = 19.0 - 26.5 V
I_{OUT} = 12.5 A
K = 1/2
R_{OUT} = 60.0 mΩ max



Product Description

The V•I Chip™ bus converter is a high efficiency (>96%), narrow input range Sine Amplitude Converter™ (SAC™) operating from a 38 to 53 Vdc primary bus to deliver an isolated 19.0 V to 26.5 V secondary. The bus converter may be used to power non-isolated POL converters or as an independent 19.0 – 26.5 V source. Due to the fast response time and low noise of the bus converter, the need for limited life aluminum electrolytic or tantalum capacitors at the load is reduced—or eliminated—resulting in savings of board area, materials and total system cost.

The bus converter achieves a power density of 1017 W /in³ in a V•I Chip package compatible with standard pick-and-place and surface mount assembly process. The V•I Chip package provides flexible thermal management through its low junction-to-board and junction-to-case thermal resistance. Owing to its high conversion efficiency and safe operating temperature range, the bus converter does not require a discrete heat sink in typical applications. Low junction-to-case and junction-to-lead thermal impedances assure low junction temperatures and long life in the harshest environments.

Absolute Maximum Ratings

Parameter	Values	Unit	Notes
+In to -In	-1.0 to 60	Vdc	
	100	Vdc	For 100 ms
PC to -In	-0.3 to 7.0	Vdc	
+Out to -Out	-0.5 to 50	Vdc	
Isolation voltage	2,250	Vdc	Input to output
Output current	14.8	A	Continuous
Peak output current	18.8	A	For 1 ms
Output power	300	W	Continuous
Peak output power	450	W	For 1 ms
Case temperature during reflow ^[a]	225	°C	MSL 5
	245	°C	MSL 6, TOB = 4 hrs
Operating junction temperature ^[b]	-40 to 125	°C	T-Grade
	-55 to 125	°C	M-Grade
	-40 to 125	°C	T-Grade
Storage temperature	-40 to 125	°C	T-Grade
	-65 to 125	°C	M-Grade

Notes:

- [a] 245°C reflow capability applies to product with manufacturing date code 1001 and greater.
 [b] The referenced junction is defined as the semiconductor having the highest temperature. This temperature is monitored by a shutdown comparator.

Part Numbering

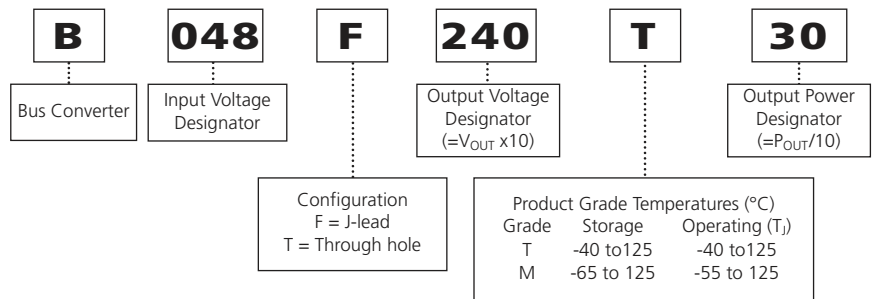

Specifications

Input (Conditions are at 48 V_{IN}, full load, and 25°C ambient unless otherwise specified)

Parameter	Min	Typ	Max	Unit	Note
Input voltage range	38	48	53	Vdc	
Input dV/dt			1	V/μs	
Input undervoltage turn on			37.4	Vdc	
Input undervoltage turn off	32.8			Vdc	
Input overvoltage turn on	53.0			Vdc	
Input overvoltage turn off			59.0	Vdc	
Input quiescent current		2.6		mA	PC low
Inrush current overshoot		3.5		A	Using test circuit in Figure 20; See Figure 1
Input current			6.8	Adc	
Input reflected ripple current		120		mA p-p	Using test circuit in Figure 20; See Figure 4
No load power dissipation		4.0	5.9	W	
Internal input capacitance		1.9		μF	
Internal input inductance		5		nH	
Recommended external input capacitance		47		μF	200 nH maximum source inductance; See Figure 20

Input Waveforms

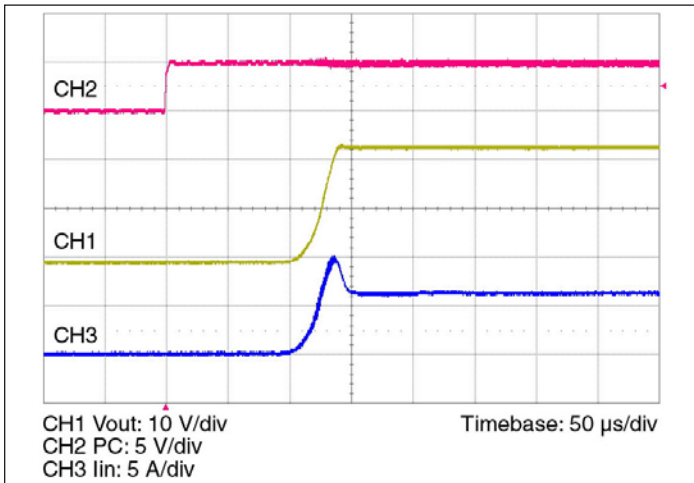

Figure 1 — Inrush transient current at full load and 48 V_{IN} with PC enabled

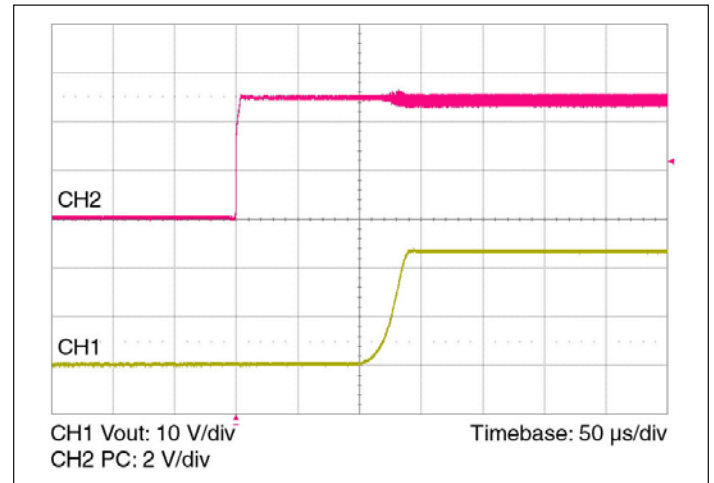

Figure 2 — Output voltage turn on waveform with PC enabled at full load and 48 V_{IN}

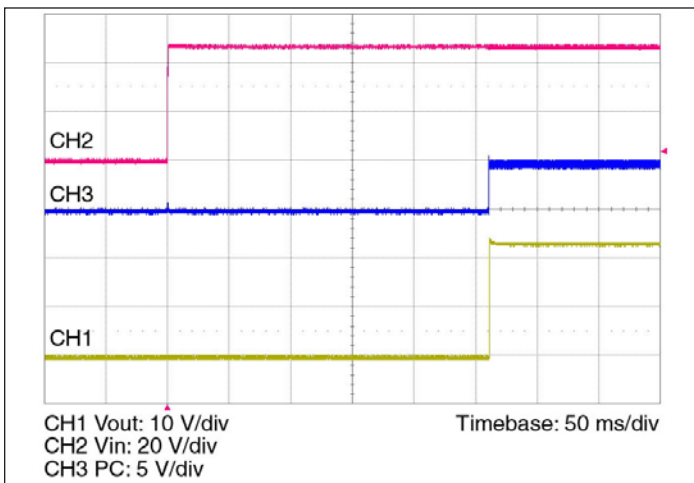

Figure 3 — Output voltage turn on waveform with input turn on at full load and 48 V_{IN}

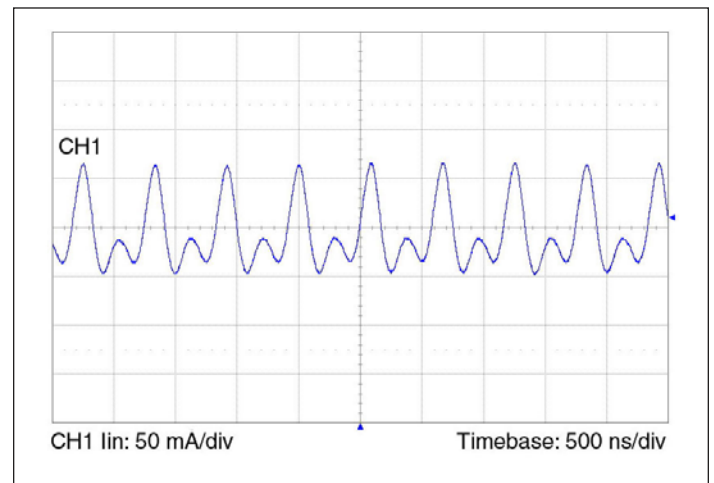

Figure 4 — Input reflected ripple current at full load and 48 V_{IN}

Specifications (continued)

Output (Conditions are at 48 Vin, full load, and 25°C ambient unless otherwise specified)

Parameter	Min	Typ	Max	Unit	Note
Output voltage	19.0		26.5	Vdc	No load
	18.3		25.8	Vdc	Full load
Output power	0		300	W	42 - 53 V _{IN}
	0		269	W	38 - 53 V _{IN}
Rated DC current	0		14.8	Adc	P _{OUT} ≤ 300 W
Peak repetitive power			450	W	Max pulse width 1ms, max duty cycle 10%, baseline power 50%
Current share accuracy		5	10	%	See Parallel Operation on Page 10
Efficiency					
Half load	95.0	95.7		%	See Figure 5
Full load	94.7	95.8		%	See Figure 5
Internal output inductance		1.1		nH	
Internal output capacitance		7.7		μF	Effective value
Load capacitance			300	μF	
Output overvoltage set point	26.5			Vdc	Module will shut down
Output ripple voltage					
No external bypass		150	348	mVp-p	See Figures 7 and 9
3.3 μF bypass capacitor		13		mVp-p	See Figure 8
Short circuit protection set point	15.1			Adc	Module will shut down
Average short circuit current		0.62		A	
Effective switching frequency	3.0	3.4	3.8	MHz	Fixed, 1.7 MHz per phase
Line regulation					
K	0.4950	1/2	0.5050		V _{OUT} = K • V _{IN} at no load
Load regulation					
R _{OUT}		43.6	60.0	mΩ	
Transient response					
Voltage overshoot		600		mV	100% load step; See Figures 10 and 11
Response time		200		ns	See Figures 10 and 11
Recovery time		1		μs	See Figures 10 and 11
Output overshoot					
Input turn on		0		mV	No output filter; See Figure 3
PC enable		0		mV	No output filter; See Figure 2
Output turn on delay					
From application of power		260		ms	No output filter; See Figure 3
From release of PC pin		65		ms	No output filter

Output Waveforms

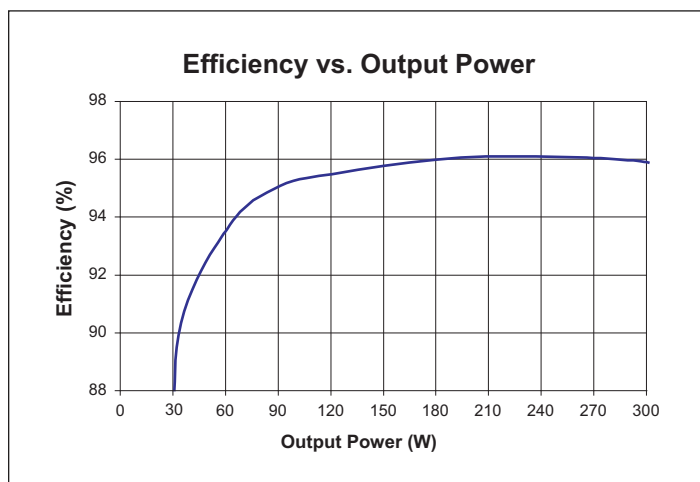

Figure 5 — Efficiency vs. output power

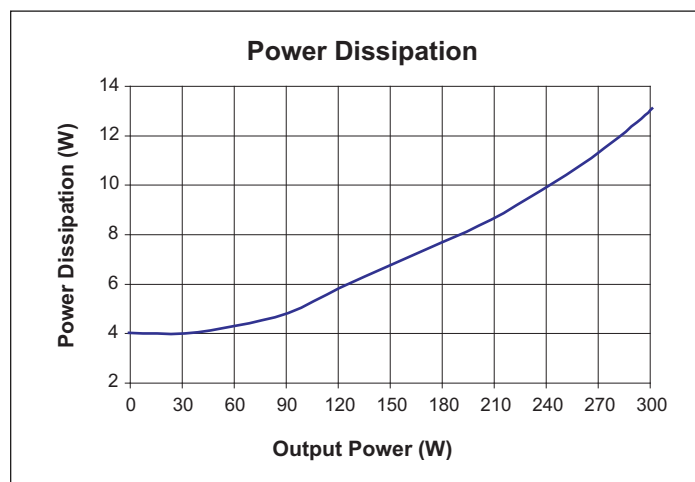

Figure 6 — Power dissipation as a function of output power

Output Waveforms

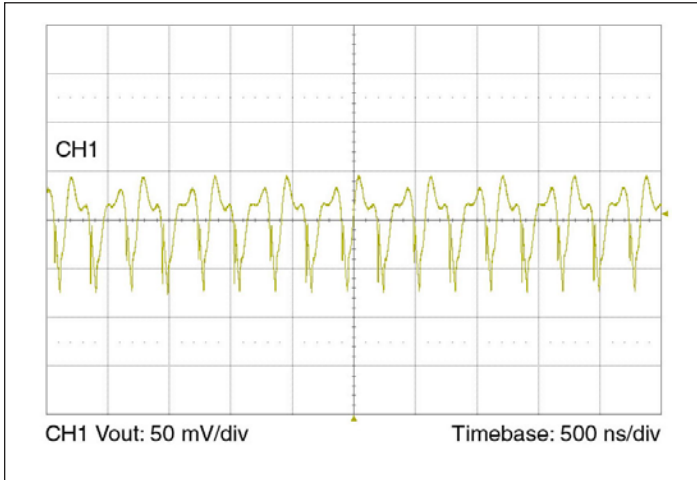

Figure 7 — Output voltage ripple at full load and 48 V_{IN} without any external bypass capacitor.

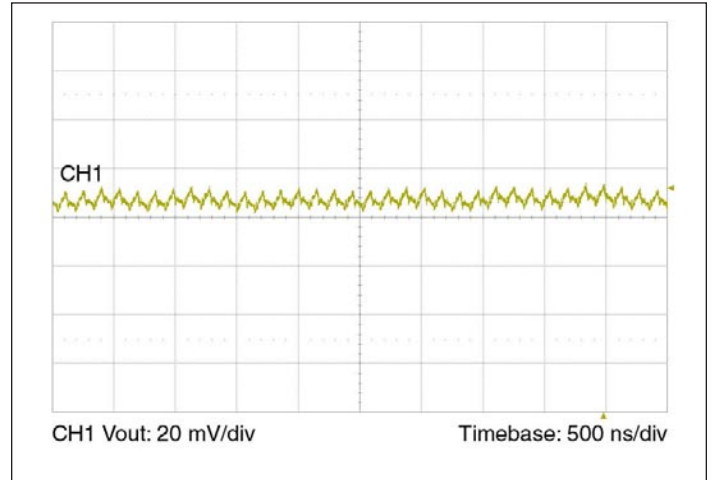

Figure 8 — Output voltage ripple at full load and 48 V_{IN} with 3.3 μF ceramic external bypass capacitor and 20 nH of distribution inductance.

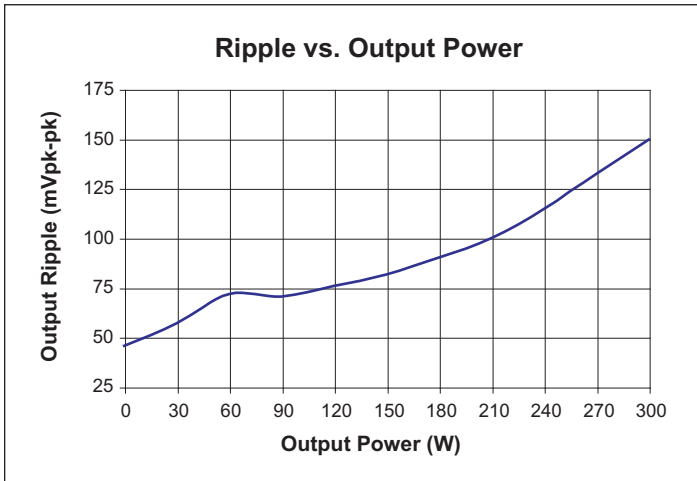

Figure 9 — Output voltage ripple vs. output power at 48 V_{IN} without any external bypass capacitor.

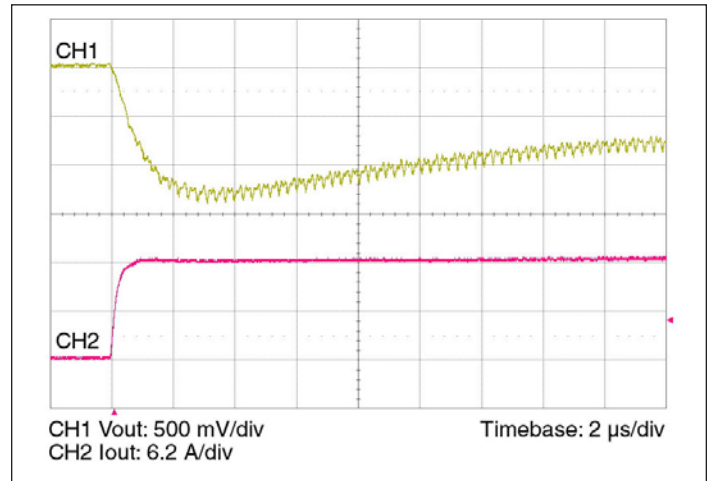

Figure 10 — 0 - 12.5 A load step with 100 μF input capacitor and no output capacitor.

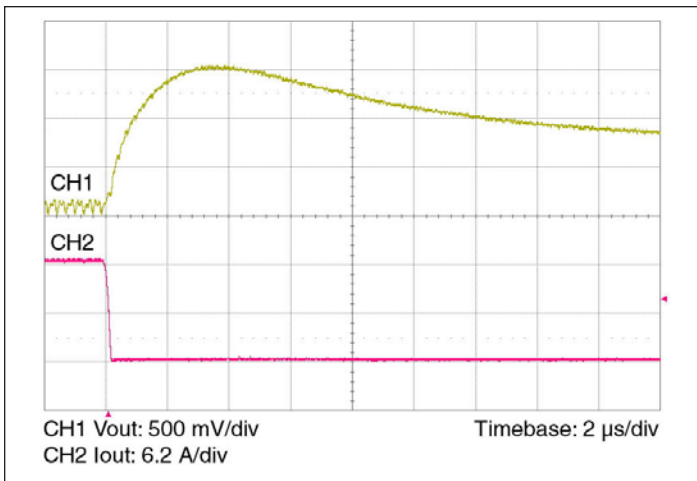

Figure 11 — 12.5 - 0 A load step with 100 μF input capacitor and no output capacitor.

Specifications (continued)

General

Parameter	Min	Typ	Max	Unit	Note
MTBF					
MIL-HDBK-217F		3.5		Mhrs	25°C, GB
Isolation specifications					
Voltage	2,250			Vdc	Input to output
Capacitance		3,000		pF	Input to output
Resistance	10			MΩ	Input to output
Agency approvals					
		cTUVus			UL/CSA 60950-1, EN 60950-1
		CE Mark			Low voltage directive
		RoHS			
Mechanical					
Weight		0.53/15		oz/g	See mechanical drawings, Figures 15 – 18
Dimensions					
Length		1.28/32,5		in/mm	
Width		0.87/22		in/mm	
Height		0.265/6,73		in/mm	
Thermal					
Overtemperature shutdown	125	130	135	°C	Junction temperature
Thermal capacity		9.3		Ws/°C	
Junction-to-case thermal impedance ($R_{\theta JC}$)		1.1		°C/W	See Thermal Considerations on Page 10
Junction-to-board thermal impedance ($R_{\theta JB}$)		2.1		°C/W	

Auxiliary Pins (Conditions are at 48 Vin, full load, and 25°C ambient unless otherwise specified)

Parameter	Min	Typ	Max	Unit	Note
Primary control (PC)					
DC voltage	4.8	5.0	5.2	Vdc	
Module disable voltage	2.4	2.5		Vdc	
Module enable voltage		2.5	2.6	Vdc	
Current limit	2.4	2.5	2.9	mA	Source only
Enable delay time		65		ms	
Disable delay time		20		μs	See Figure 12, time from PC low to output low

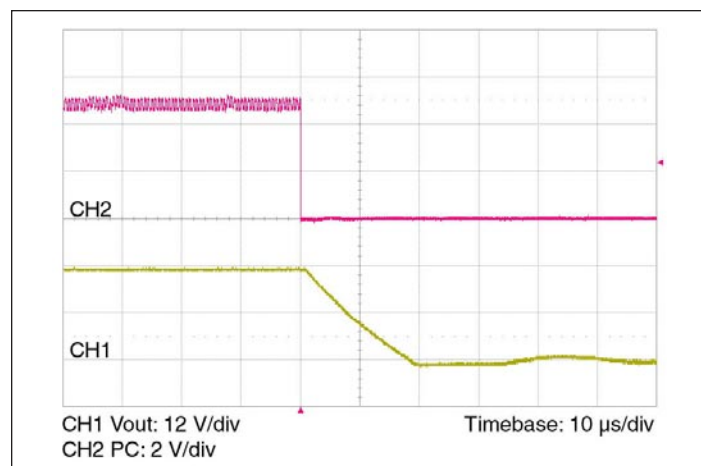

Figure 12 — V_{OUT} at full load vs. PC disable

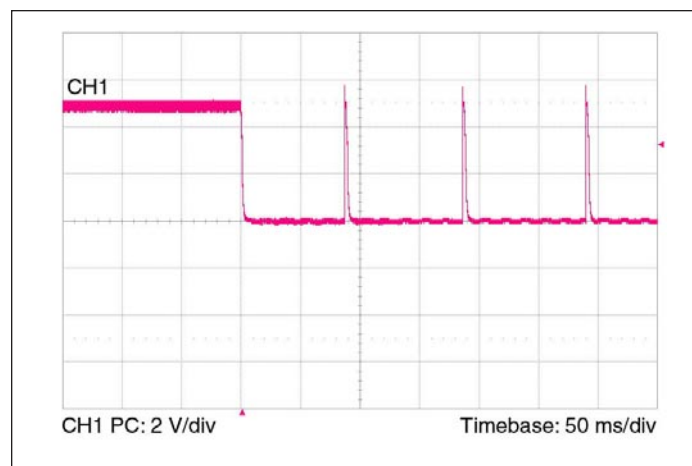

Figure 13 — PC signal during fault

Pin / Control Functions

+In / -In – DC Voltage Input Ports

The V•I Chip™ module input voltage range should not be exceeded. An internal undervoltage/overvoltage lockout function prevents operation outside of the normal operating input range. The BCM™ bus converter turns on within an input voltage window bounded by the “Input undervoltage turn on” and “Input overvoltage turn off” levels, as specified. The module may be protected against accidental application of a reverse input voltage by the addition of a rectifier in series with the positive input, or a reverse rectifier in shunt with the positive input located on the load side of the input fuse.

The connection of the module to its power source should be implemented with minimal distribution inductance. If the interconnect inductance exceeds 100 nH, the input should be bypassed with a RC damper to retain low source impedance and stable operation. With an interconnect inductance of 200 nH, the RC damper may be 47 μ F in series with 0.3 Ω . A single electrolytic or equivalent low-Q capacitor may be used in place of the series RC bypass.

PC – Primary Control

The Primary Control port is a multifunction node that provides the following functions:

Enable / Disable – If the PC port is left floating, the BCM™ module output is enabled. Once this port is pulled lower than 2.4 Vdc with respect to -In, the output is disabled. This action can be realized by employing a relay, opto-coupler, or open collector transistor. Refer to Figures 1-3, 12 and 13 for the typical enable/disable characteristics. This port should not be toggled at a rate higher than 1 Hz. The PC port should also not be driven by or pulled up to an external voltage source.

Primary Auxiliary Supply – The PC port can source up to 2.4 mA at 5.0 Vdc. The PC port should never be used to sink current.

Alarm – The module contains circuitry that monitors output overload, input overvoltage or undervoltage, and internal junction temperatures. In response to an abnormal condition in any of the monitored parameters, the PC port will toggle. Refer to Figure 13 for PC alarm characteristics.

TM and RSV – Reserved for factory use.

+Out / -Out – DC Voltage Output Ports

Two sets of contacts are provided for the +Out port. They must be connected in parallel with low interconnect resistance. Similarly, two sets of contacts are provided for the -Out port. They must be connected in parallel with low interconnect resistance. Within the specified operating range, the average output voltage is defined by the Level 1 DC behavioral model of Figure 21. The current source capability of the module is rated in the specifications section of this document.

The low output impedance of the module reduces or eliminates the need for limited life aluminum electrolytic or tantalum capacitors at the input of POL converters.

Total load capacitance at the output of the modules should not exceed the specified maximum. Owing to the wide bandwidth and low output impedance of the module, low frequency bypass capacitance and significant energy storage may be more densely and efficiently provided by adding capacitance at the input of the BCM module.

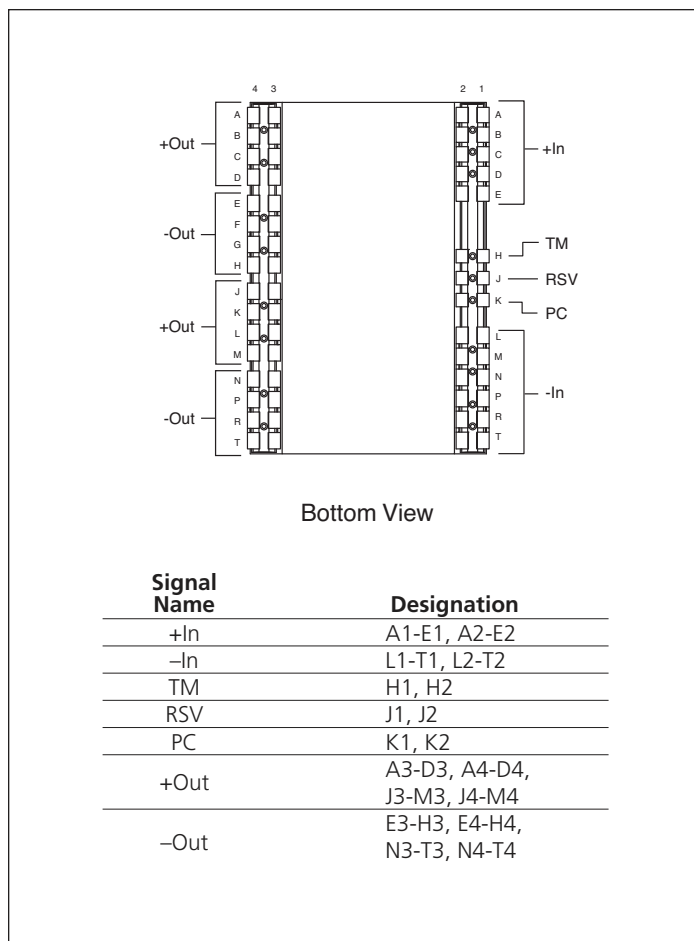

Figure 14 — BCM™ bus converter pin configuration

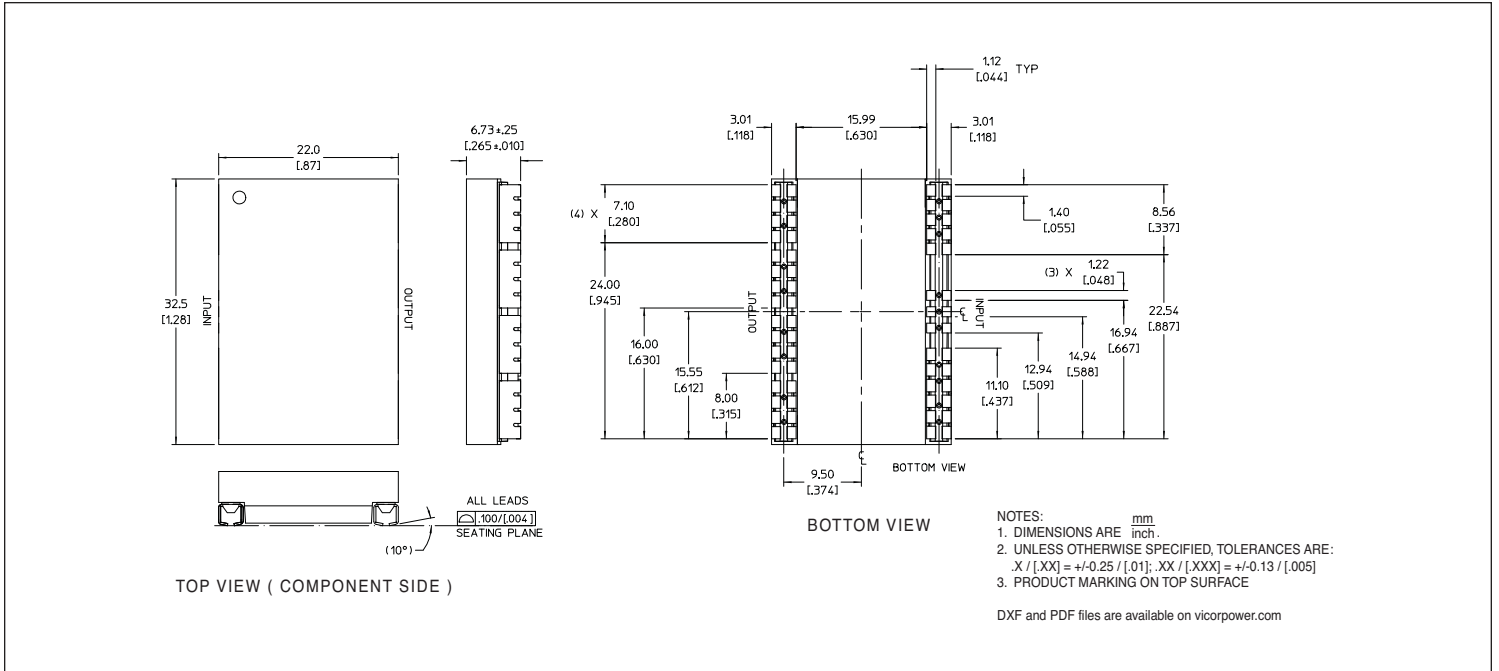

Figure 15 — BCM™ module J-Lead mechanical outline; onboard mounting

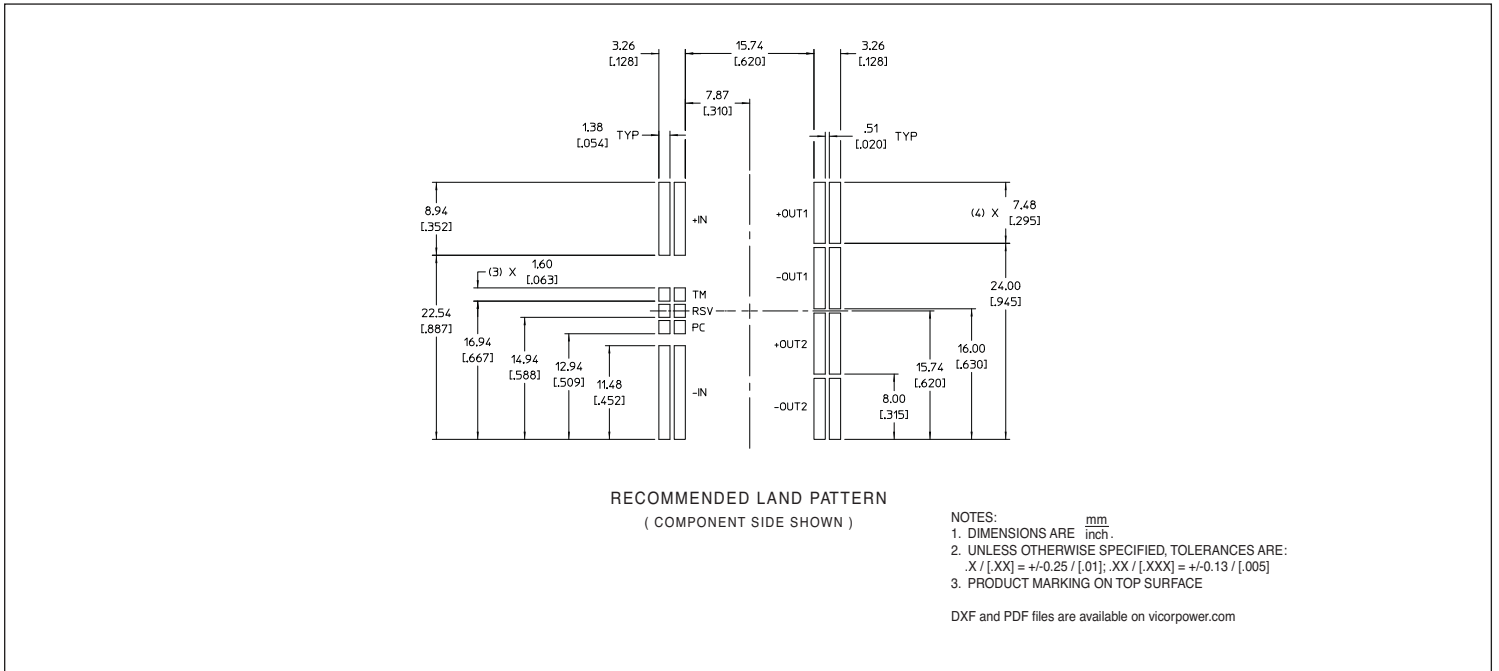

Figure 16 — BCM™ module PCB land layout information

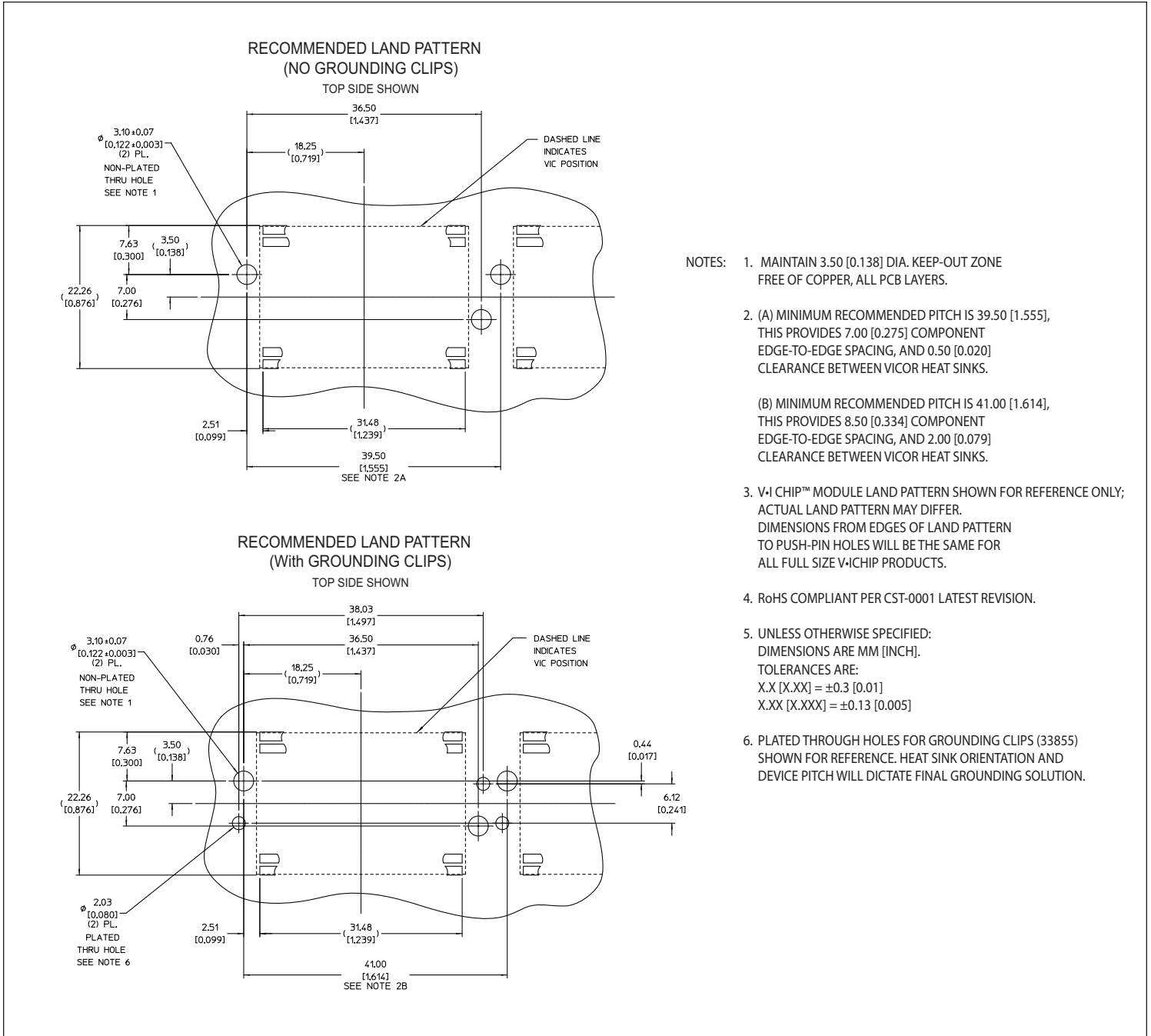

Figure 19 — Hole location for push pin heat sink relative to V-I Chip™ module

Parallel Operation

The BCM™ bus converter will inherently current share when operated in an array. Arrays may be used for higher power or redundancy in an application.

Current sharing accuracy is maximized when the source and load impedance presented to each bus converter within an array are equal. The recommended method to achieve matched impedances is to dedicate common copper planes within the PCB to deliver and return the current to the array, rather than rely upon traces of varying lengths. In typical applications the current being delivered to the load is larger than that sourced from the input, allowing traces to be utilized on the input side if necessary. The use of dedicated power planes is, however, preferable.

The bus converter power train and control architecture allow bi-directional power transfer, including reverse power processing from the module output to its input. Reverse power transfer is enabled if the module input is within its operating range and the module is otherwise enabled. The bus converter's ability to process power in reverse improves the module's transient response to an output load dump.

Thermal Considerations

V•I Chip™ products are multi-chip modules whose temperature distribution varies greatly for each part number as well as with the input/output conditions, thermal management and environmental conditions. Maintaining the top of the B048F240T30 case to less than 100°C will keep all junctions within the module below 125°C for most applications. The percent of total heat dissipated through the top surface versus through the J-lead is entirely dependent on the particular mechanical and thermal environment. The heat dissipated through the top surface is typically 60%. The heat dissipated through the J-lead onto the PCB board surface is typically 40%. Use 100% top surface dissipation when designing for a conservative cooling solution. It is not recommended to use a module for an extended period of time at full load without proper heat sinking.

Input Impedance Recommendations

To take full advantage of the BCM™ bus converter capabilities, the impedance presented to its input terminals must be low from DC to approximately 5 MHz. The source should exhibit low inductance and should have a critically damped response. If the interconnect inductance is excessive, the module input pins should be bypassed with an RC damper (e.g., 47 µF in series with 0.3 ohm) to retain low source impedance and proper operation. Given the wide bandwidth of the module, the source response is generally the limiting factor in the overall system response.

Anomalies in the response of the source will appear at the output of the module multiplied by its K factor. The DC resistance of the source should be kept as low as possible to minimize voltage deviations. This is especially important if the module is operated near low or high line as the overvoltage/undervoltage detection circuitry could be activated.

Input Fuse Recommendations

V•I Chip modules are not internally fused in order to provide flexibility in configuring power systems. However, input line fusing of the modules must always be incorporated within the power system. A fast acting fuse should be placed in series with the +In port.

Application Notes

For application notes on soldering, thermal management, board layout, and system design click on the link below:

http://www.vicorpower.com/technical_library/application_information/chips/

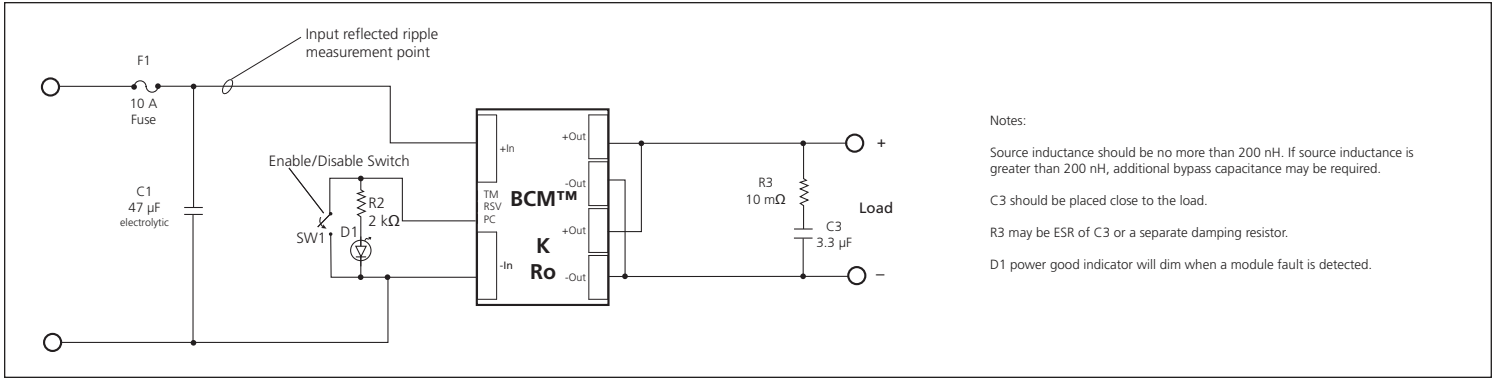

Figure 20 — BCM™ module test circuit

BCM™ Bus Converter Level 1 DC Behavioral Model for 48 V to 24 V, 300 W

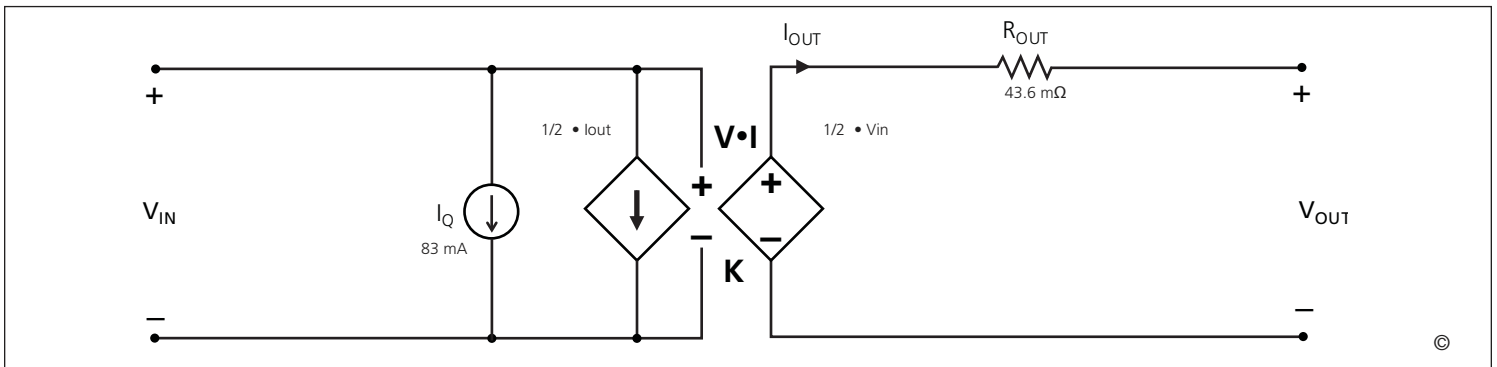

Figure 21 — This model characterizes the DC operation of the bus converter, including the converter transfer function and its losses. The model enables estimates or simulations of output voltage as a function of input voltage and output load, as well as total converter power dissipation or heat generation.

BCM™ Bus Converter Level 2 Transient Behavioral Model for 48 V to 24 V, 300 W

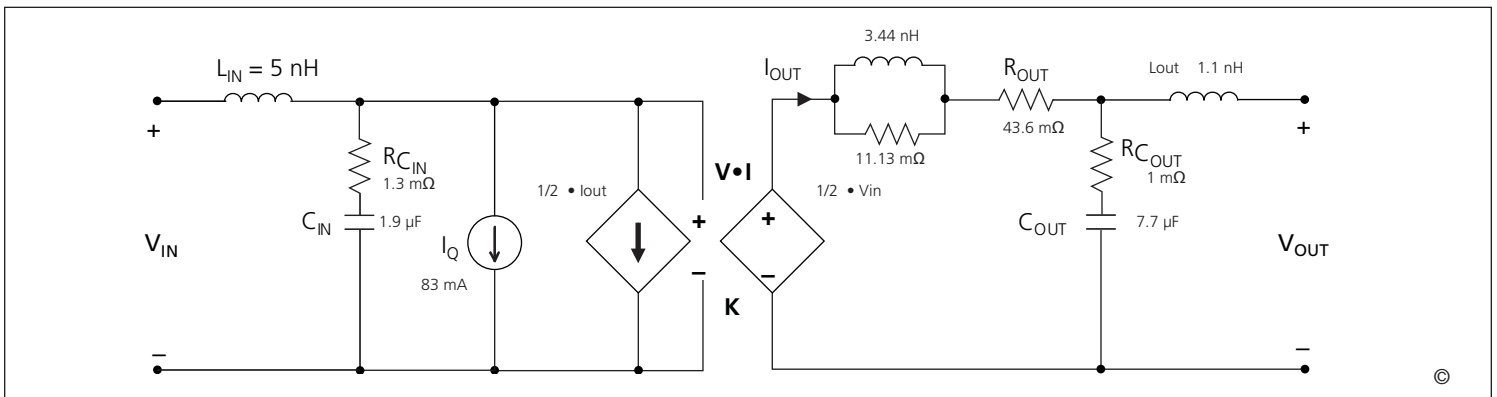

Figure 22 — This model characterizes the AC operation of the bus converter including response to output load or input voltage transients or steady state modulations. The model enables estimates or simulations of input and output voltages under transient conditions, including response to a stepped load with or without external filtering elements.

Vicor's comprehensive line of power solutions includes high density AC-DC and DC-DC modules and accessory components, fully configurable AC-DC and DC-DC power supplies, and complete custom power systems.

Information furnished by Vicor is believed to be accurate and reliable. However, no responsibility is assumed by Vicor for its use. Vicor makes no representations or warranties with respect to the accuracy or completeness of the contents of this publication. Vicor reserves the right to make changes to any products, specifications, and product descriptions at any time without notice. Information published by Vicor has been checked and is believed to be accurate at the time it was printed; however, Vicor assumes no responsibility for inaccuracies. Testing and other quality controls are used to the extent Vicor deems necessary to support Vicor's product warranty. Except where mandated by government requirements, testing of all parameters of each product is not necessarily performed.

Specifications are subject to change without notice.

Vicor's Standard Terms and Conditions

All sales are subject to Vicor's Standard Terms and Conditions of Sale, which are available on Vicor's webpage or upon request.

Product Warranty

In Vicor's standard terms and conditions of sale, Vicor warrants that its products are free from non-conformity to its Standard Specifications (the "Express Limited Warranty"). This warranty is extended only to the original Buyer for the period expiring two (2) years after the date of shipment and is not transferable.

UNLESS OTHERWISE EXPRESSLY STATED IN A WRITTEN SALES AGREEMENT SIGNED BY A DULY AUTHORIZED VICOR SIGNATORY, VICOR DISCLAIMS ALL REPRESENTATIONS, LIABILITIES, AND WARRANTIES OF ANY KIND (WHETHER ARISING BY IMPLICATION OR BY OPERATION OF LAW) WITH RESPECT TO THE PRODUCTS, INCLUDING, WITHOUT LIMITATION, ANY WARRANTIES OR REPRESENTATIONS AS TO MERCHANTABILITY, FITNESS FOR PARTICULAR PURPOSE, INFRINGEMENT OF ANY PATENT, COPYRIGHT, OR OTHER INTELLECTUAL PROPERTY RIGHT, OR ANY OTHER MATTER.

This warranty does not extend to products subjected to misuse, accident, or improper application, maintenance, or storage. Vicor shall not be liable for collateral or consequential damage. Vicor disclaims any and all liability arising out of the application or use of any product or circuit and assumes no liability for applications assistance or buyer product design. Buyers are responsible for their products and applications using Vicor products and components. Prior to using or distributing any products that include Vicor components, buyers should provide adequate design, testing and operating safeguards.

Vicor will repair or replace defective products in accordance with its own best judgment. For service under this warranty, the buyer must contact Vicor to obtain a Return Material Authorization (RMA) number and shipping instructions. Products returned without prior authorization will be returned to the buyer. The buyer will pay all charges incurred in returning the product to the factory. Vicor will pay all reshipment charges if the product was defective within the terms of this warranty.

Life Support Policy

VICOR'S PRODUCTS ARE NOT AUTHORIZED FOR USE AS CRITICAL COMPONENTS IN LIFE SUPPORT DEVICES OR SYSTEMS WITHOUT THE EXPRESS PRIOR WRITTEN APPROVAL OF THE CHIEF EXECUTIVE OFFICER AND GENERAL COUNSEL OF VICOR CORPORATION. As used herein, life support devices or systems are devices which (a) are intended for surgical implant into the body, or (b) support or sustain life and whose failure to perform when properly used in accordance with instructions for use provided in the labeling can be reasonably expected to result in a significant injury to the user. A critical component is any component in a life support device or system whose failure to perform can be reasonably expected to cause the failure of the life support device or system or to affect its safety or effectiveness. Per Vicor Terms and Conditions of Sale, the user of Vicor products and components in life support applications assumes all risks of such use and indemnifies Vicor against all liability and damages.

Intellectual Property Notice

Vicor and its subsidiaries own Intellectual Property (including issued U.S. and Foreign Patents and pending patent applications) relating to the products described in this data sheet. No license, whether express, implied, or arising by estoppel or otherwise, to any intellectual property rights is granted by this document. Interested parties should contact Vicor's Intellectual Property Department.

The products described on this data sheet are protected by the following U.S. Patents Numbers:

5,945,130; 6,403,009; 6,710,257; 6,911,848; 6,930,893; 6,934,166; 6,940,013; 6,969,909; 7,038,917; 7,166,898; 7,187,263; 7,361,844; D496,906; D505,114; D506,438; D509,472 and for use under 6,975,098 and 6,984,965.

Vicor Corporation

25 Frontage Road
Andover, MA, USA 01810
Tel: 800-735-6200
Fax: 978-475-6715

email

Customer Service: custserv@vicorpower.com

Technical Support: apps@vicorpower.com