

MCR716, MCR718

Preferred Device

Sensitive Gate Silicon Controlled Rectifiers

Reverse Blocking Thyristors

Designed for high volume, low cost, industrial and consumer applications such as motor control, process control, temperature, light and speed control.

Features

- Small Size
- Passivated Die for Reliability and Uniformity
- Low Level Triggering and Holding Characteristics
- Surface Mount Lead Form – Case 369C
- Epoxy Meets UL 94 V-0 @ 0.125 in
- ESD Ratings: Human Body Model, 3B > 8000 V
Machine Model, C > 400 V
- Pb-Free Packages are Available

MAXIMUM RATINGS (T_J = 25°C unless otherwise noted)

| Rating | Symbol | Value | Unit |
|--|--|-------------|--------------------|
| Peak Repetitive Off-State Voltage (Note 1) (T _J = -40 to 110°C, Sine Wave, 50 to 60 Hz, R _{GK} = 1 kΩ) | V _{DRM} , V _{RRM} | 400 600 | V |
| On-State RMS Current (180° Conduction Angles; T _C = 90°C) | I _{T(RMS)} | 4.0 | A |
| Average On-State Current (180° Conduction Angles; T _C = 90°C) | I _{T(AV)} | 2.6 | A |
| Peak Non-Repetitive Surge Current (1/2 Cycle, Sine Wave 60 Hz, T _J = 110°C) | I _{TSM} | 25 | A |
| Circuit Fusing Consideration (t = 8.3 msec) | I ² t | 2.6 | A ² sec |
| Forward Peak Gate Power (Pulse Width ≤ 1.0 μsec, T _C = 90°C) | P _{GM} | 0.5 | W |
| Forward Average Gate Power (t = 8.3 msec, T _C = 90°C) | P _{G(AV)} | 0.1 | W |
| Forward Peak Gate Current (Pulse Width ≤ 1.0 μsec, T _C = 90°C) | I _{GM} | 0.2 | A |
| Operating Junction Temperature Range | T _J | -40 to +110 | °C |
| Storage Temperature Range | T _{stg} | -40 to +150 | °C |

Stresses exceeding Maximum Ratings may damage the device. Maximum Ratings are stress ratings only. Functional operation above the Recommended Operating Conditions is not implied. Extended exposure to stresses above the Recommended Operating Conditions may affect device reliability.

1. V_{DRM} and V_{RRM} for all types can be applied on a continuous basis. Ratings apply for zero or negative gate voltage; positive gate voltage shall not be applied concurrent with negative potential on the anode. Blocking voltages shall not be tested with a constant current source such that the voltage ratings of the devices are exceeded.



Expertise Applied | Answers Delivered

Littelfuse.com

SCRs
4.0 AMPERES RMS
400 – 600 VOLTS

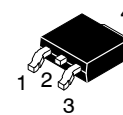

DPAK
CASE 369C
STYLE 4

MARKING DIAGRAM

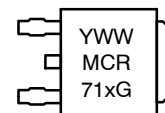

- Y = Year
- WW = Work Week
- MCR71x = Device Code
x = 6 or 8
- G = Pb-Free Package

PIN ASSIGNMENT

| Pin | Assignment |
|-----|------------|
| 1 | Cathode |
| 2 | Anode |
| 3 | Gate |
| 4 | Anode |

ORDERING INFORMATION

See detailed ordering and shipping information in the package dimensions section on page 2 of this data sheet.

Preferred devices are recommended choices for future use and best overall value.

MCR716, MCR718

THERMAL CHARACTERISTICS

| Characteristic | Symbol | Max | Unit |
|---|-----------------|-----|---------------|
| Thermal Resistance, Junction-to-Case | $R_{\theta JC}$ | 3.0 | $^{\circ}C/W$ |
| Thermal Resistance, Junction-to-Ambient (Note 2) | $R_{\theta JA}$ | 80 | $^{\circ}C/W$ |
| Maximum Lead Temperature for Soldering Purposes 1/8" from Case for 10 Seconds | T_L | 260 | $^{\circ}C$ |

ELECTRICAL CHARACTERISTICS ($T_C = 25^{\circ}C$ unless otherwise noted.)

| Characteristic | Symbol | Min | Typ | Max | Unit |
|----------------|--------|-----|-----|-----|------|
|----------------|--------|-----|-----|-----|------|

OFF CHARACTERISTICS

| | | | | | |
|--|-----------|---|---|-----|----------------------|
| Peak Repetitive Forward or Reverse Blocking Current; $R_{GK} = 1\text{ k}\Omega$ (Note 3) ($V_{AK} = \text{Rated } V_{DRM}$ or V_{RRM}) | I_{DRM} | - | - | 10 | μA |
| | I_{RRM} | - | - | 200 | |
| | | | | | $T_C = 25^{\circ}C$ |
| | | | | | $T_C = 110^{\circ}C$ |

ON CHARACTERISTICS

| | | | | | |
|--|-----------|-----|------|-----|---------|
| Peak Reverse Gate Blocking Voltage ($I_{GR} = 10\text{ }\mu A$) | V_{RGM} | 10 | 12.5 | 18 | V |
| Peak Reverse Gate Blocking Current ($V_{GR} = 10\text{ V}$) | I_{RGM} | - | - | 1.2 | μA |
| Peak Forward On-State Voltage (Note 4) ($I_{TM} = 5.0\text{ A Peak}$) ($I_{TM} = 8.2\text{ A Peak}$) | V_{TM} | - | 1.3 | 1.5 | V |
| | | - | 1.5 | 2.2 | |
| Gate Trigger Current (Continuous dc) (Note 5) ($V_D = 12\text{ Vdc}$, $R_L = 30\text{ }\Omega$) | I_{GT} | 1.0 | 25 | 75 | μA |
| | | - | - | 300 | |
| Gate Trigger Voltage (Continuous dc) (Note 5) ($V_D = 12\text{ Vdc}$, $R_L = 30\text{ }\Omega$) | V_{GT} | 0.3 | 0.55 | 0.8 | V |
| | | - | - | 1.0 | |
| | | 0.2 | - | - | |
| Holding Current (Note 3) ($V_D = 12\text{ Vdc}$, Initiating Current = 20 mA, $R_{GK} = 1\text{ k}\Omega$) | I_H | 0.4 | 1.0 | 5.0 | mA |
| | | - | - | 10 | |
| Latching Current (Note 3) ($R_{GK} = 1\text{ k}\Omega$) ($V_D = 12\text{ Vdc}$, $I_G = 2.0\text{ mA}$, $T_C = 25^{\circ}C$) ($V_D = 12\text{ Vdc}$, $I_G = 2.0\text{ mA}$, $T_C = -40^{\circ}C$) | I_L | - | - | 5.0 | mA |
| | | - | - | 10 | |
| Total Turn-On Time (Source Voltage = 12 V, $R_S = 6\text{ k}\Omega$, $I_T = 8\text{ A(pk)}$, $R_{GK} = 1\text{ k}\Omega$) ($V_D = \text{Rated } V_{DRM}$, Rise Time = 20 ns, Pulse Width = 10 μs) | t_{gt} | - | 2.0 | 5.0 | μs |

DYNAMIC CHARACTERISTICS

| | | | | | |
|--|---------|-----|----|-----|------------|
| Critical Rate of Rise of Off-State Voltage ($V_D = 0.67 \times \text{Rated } V_{DRM}$, $R_{GK} = 1\text{ k}\Omega$, Exponential Waveform, $T_J = 110^{\circ}C$) | dv/dt | 5.0 | 10 | - | V/ μs |
| Repetitive Critical Rate of Rise of On-State Current ($f = 60\text{ Hz}$, $I_{PK} = 30\text{ A}$, $PW = 100\text{ }\mu s$, $dIG/dt = 1\text{ A}/\mu s$) | di/dt | - | - | 100 | A/ μs |

- Case 369C, when surface mounted on minimum recommended pad size.
- Ratings apply for negative gate voltage or $R_{GK} = 1\text{ k}\Omega$. Devices shall not have a positive gate voltage concurrently with a negative voltage on the anode. Devices should not be tested with a constant current source for forward and reverse blocking capability such that the voltage applied exceeds the rated blocking voltage.
- Pulse Test: Pulse Width $\leq 2\text{ ms}$, Duty Cycle $\leq 2\%$.
- R_{GK} current not included in measurements.

ORDERING INFORMATION

| Device | Package | Shipping |
|-----------|-------------------|----------------------|
| MCR716T4 | DPAK | 2500 / Tape and Reel |
| MCR716T4G | DPAK (Pb-Free) | |
| MCR718T4 | DPAK | |
| MCR718T4G | DPAK (Pb-Free) | |

MCR716, MCR718

Voltage Current Characteristic of SCR

| Symbol | Parameter |
|-----------|---|
| V_{DRM} | Peak Repetitive Off-State Forward Voltage |
| I_{DRM} | Peak Forward Blocking Current |
| V_{RRM} | Peak Repetitive Off-State Reverse Voltage |
| I_{RRM} | Peak Reverse Blocking Current |
| V_{TM} | Peak On-State Voltage |
| I_H | Holding Current |

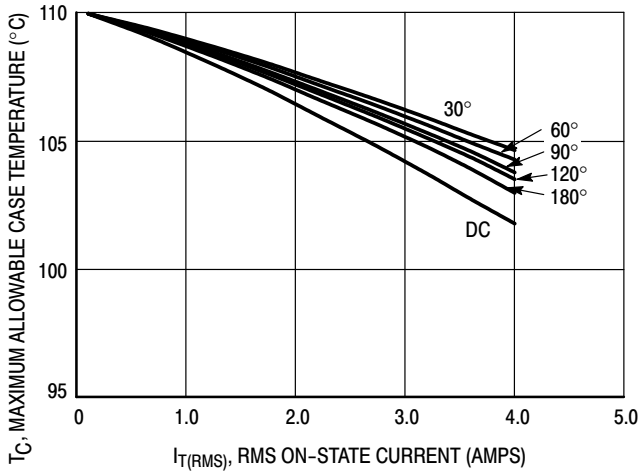
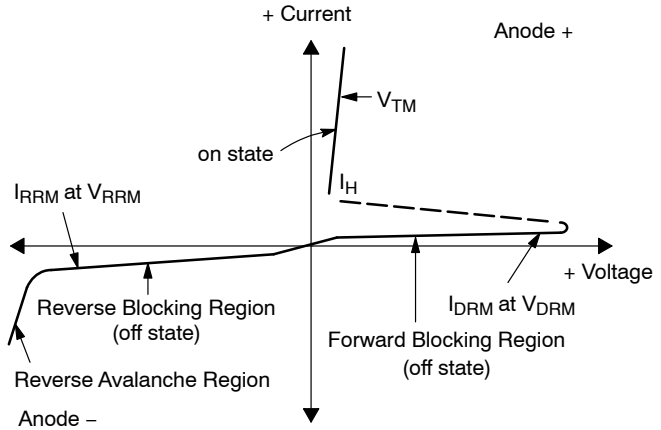

Figure 1. RMS Current Derating

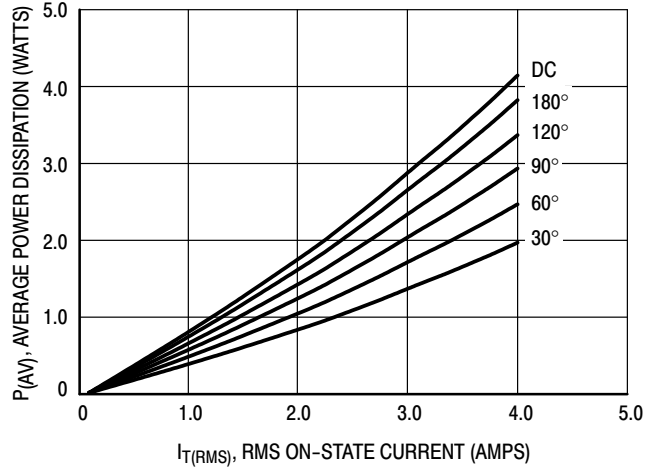

Figure 2. On-State Power Dissipation

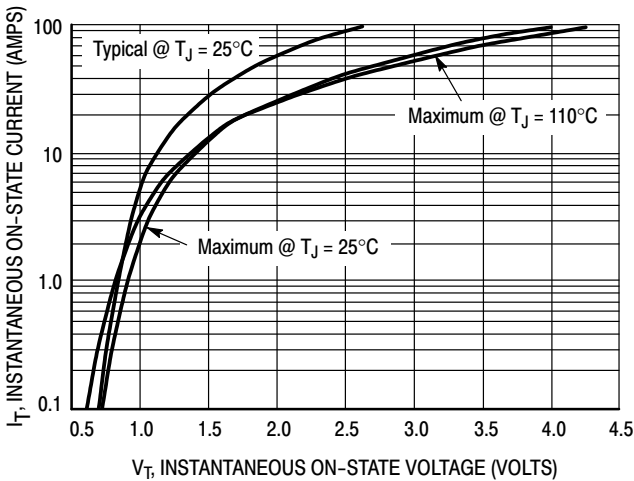

Figure 3. On-State Characteristics

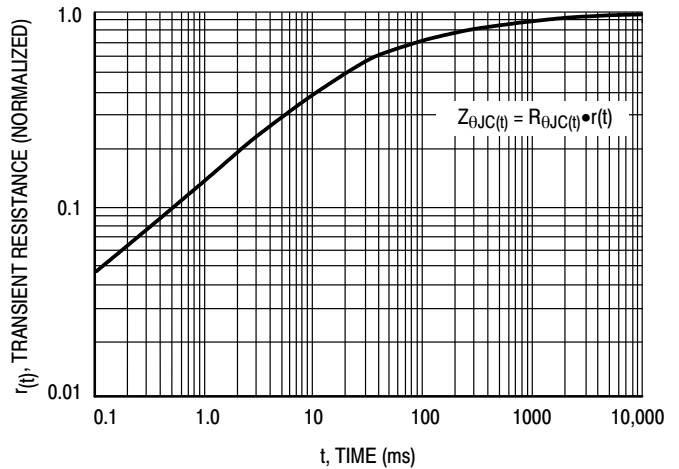

Figure 4. Transient Thermal Response

MCR716, MCR718

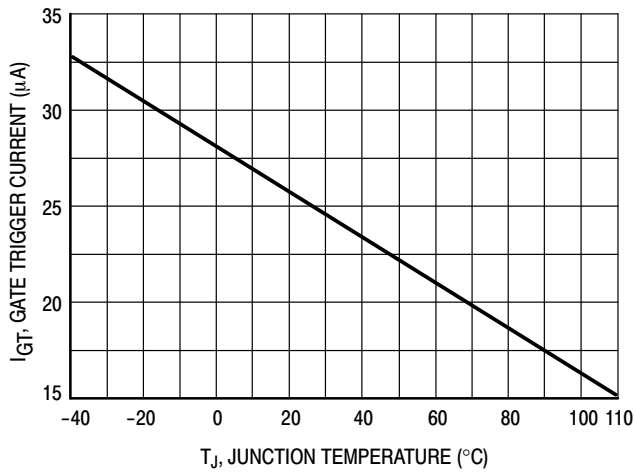

Figure 5. Typical Gate Trigger Current versus Junction Temperature

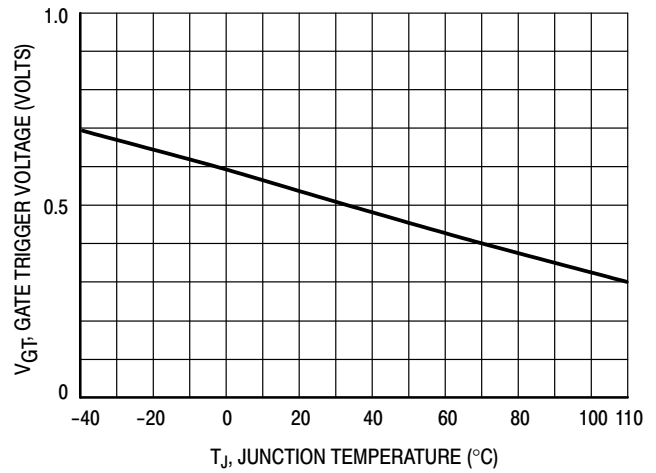

Figure 6. Typical Gate Trigger Voltage versus Junction Temperature

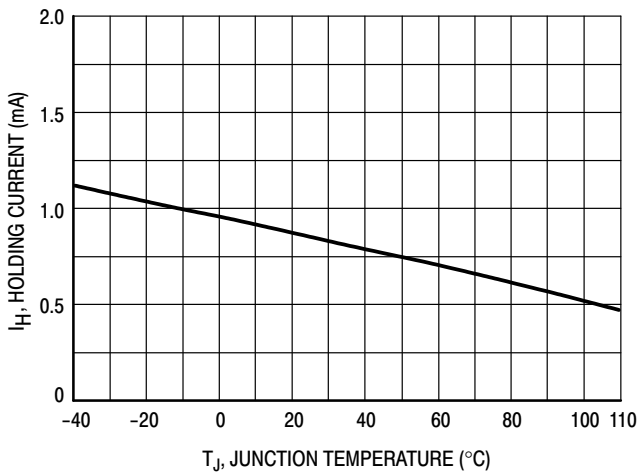

Figure 7. Typical Holding Current versus Junction Temperature

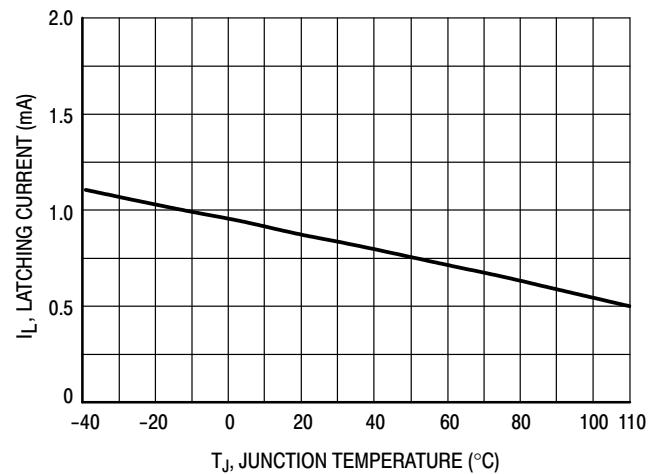
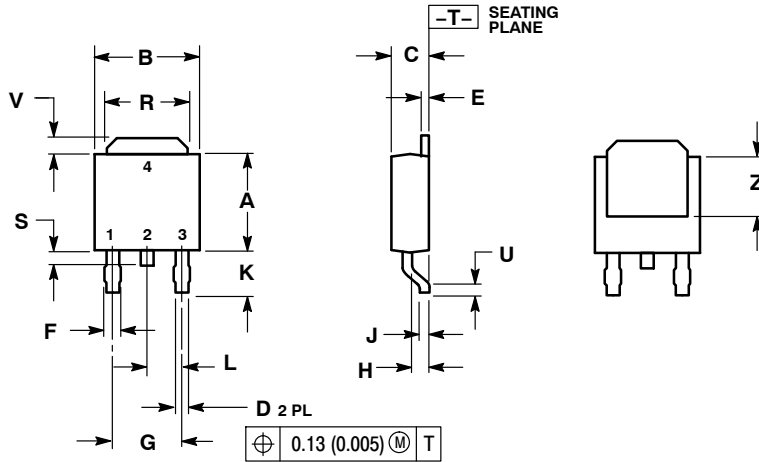

Figure 8. Typical Latching Current versus Junction Temperature

MCR716, MCR718

PACKAGE DIMENSIONS

DPAK
CASE 369C-01
ISSUE A



- NOTES:
1. DIMENSIONING AND TOLERANCING PER ANSI Y14.5M, 1982.
2. CONTROLLING DIMENSION: INCH.

| DIM | INCHES | | MILLIMETERS | |
|-----|-----------|-------|-------------|------|
| | MIN | MAX | MIN | MAX |
| A | 0.235 | 0.245 | 5.97 | 6.22 |
| B | 0.250 | 0.265 | 6.35 | 6.73 |
| C | 0.086 | 0.094 | 2.19 | 2.38 |
| D | 0.027 | 0.035 | 0.69 | 0.88 |
| E | 0.018 | 0.023 | 0.46 | 0.58 |
| F | 0.037 | 0.045 | 0.94 | 1.14 |
| G | 0.180 BSC | | 4.58 BSC | |
| H | 0.034 | 0.040 | 0.87 | 1.01 |
| J | 0.018 | 0.023 | 0.46 | 0.58 |
| K | 0.102 | 0.114 | 2.60 | 2.89 |
| L | 0.090 BSC | | 2.29 BSC | |
| R | 0.180 | 0.215 | 4.57 | 5.45 |
| S | 0.025 | 0.040 | 0.63 | 1.01 |
| U | 0.020 | --- | 0.51 | --- |
| V | 0.035 | 0.050 | 0.89 | 1.27 |
| Z | 0.155 | --- | 3.93 | --- |

STYLE 4:
PIN 1. CATHODE
2. ANODE
3. GATE
4. ANODE

SOLDERING FOOTPRINT

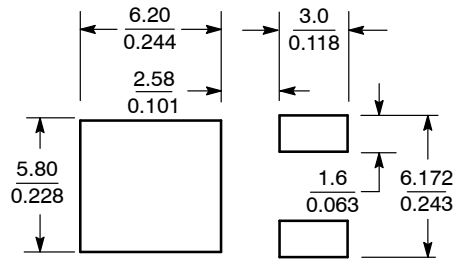

SCALE 3:1 $\left(\frac{\text{mm}}{\text{inches}}\right)$

Littelfuse products are not designed for, and shall not be used for, any purpose (including, without limitation, automotive, military, aerospace, medical, life-saving, life-sustaining or nuclear facility applications, devices intended for surgical implant into the body, or any other application in which the failure or lack of desired operation of the product may result in personal injury, death, or property damage) other than those expressly set forth in applicable Littelfuse product documentation. Warranties granted by Littelfuse shall be deemed void for products used for any purpose not expressly set forth in applicable Littelfuse documentation. Littelfuse shall not be liable for any claims or damages arising out of products used in applications not expressly intended by Littelfuse as set forth in applicable Littelfuse documentation. The sale and use of Littelfuse products is subject to Littelfuse Terms and Conditions of Sale, unless otherwise agreed by Littelfuse.

Littelfuse.com