

**3W FILTERLESS STEREO CLASS-D AUDIO AMPLIFIER WITH DIGITAL VOLUME CONTROL**

**Description**

The PAM8803 is a 3W, class-D audio amplifier with 64-step digital volume control. It offers low THD+N, allowing it to produce high-quality sound reproduction. The new filterless architecture allows the device to drive the speaker directly, without needing low-pass output filters which will save 30% system cost and 75% PCB area.

With the same numbers of external components, the efficiency of the PAM8803 is much better than class-AB cousins. It extends battery life, making it ideal for portable applications.

The PAM8803 is available in a SSOP-24 package.

**Features**

- 3W Output at 10% THD with a 4Ω Load and 5V Power Supply
- Filterless, Low Quiescent Current and Low EMI
- Low THD+N
- 64-Step Digital Volume Control
- Superior Low Noise
- Low Pop Noise
- Efficiency up to 90%
- Short Circuit Protection
- Thermal Shutdown
- Few External Components to Save Space and Cost
- Pb-Free Packages

**Pin Assignments**

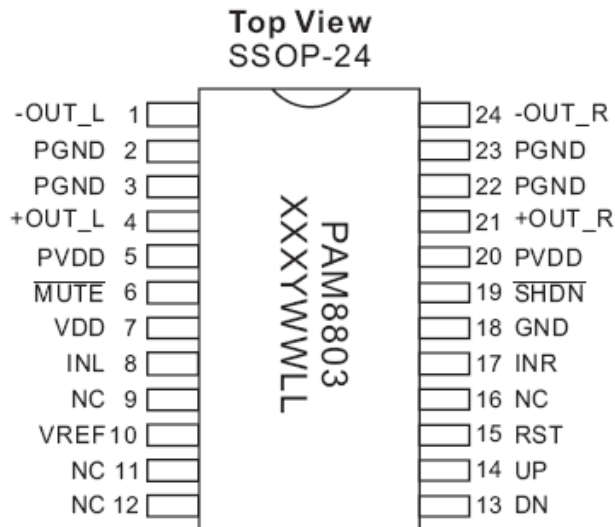

**Applications**

- LCD Monitors/TV Projectors
- Notebook Computers
- Portable Speakers
- Portable DVD Players, Game Machines
- Cellular Phones/Speaker Phones

**Typical Applications Circuit**

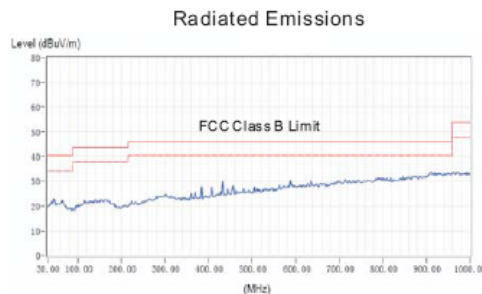
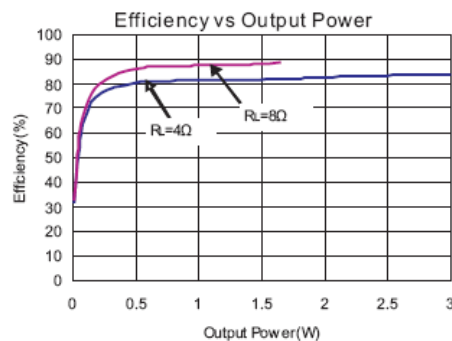
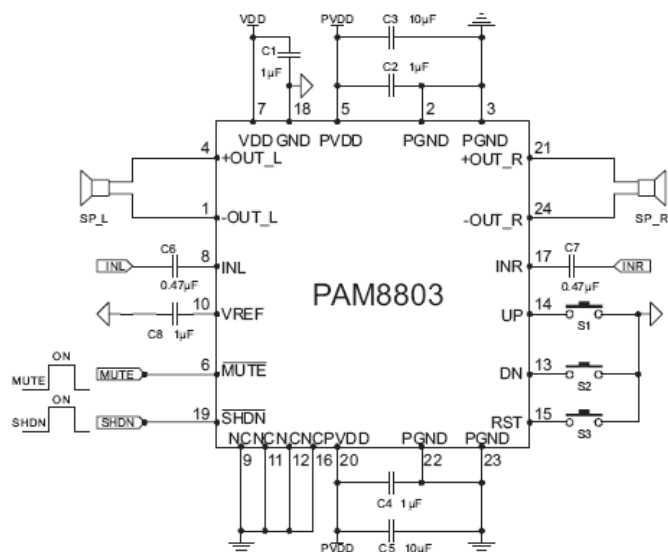

## Pin Descriptions

Pin Number	Pin Name	Function
1	-OUT_L	Left Channel Negative Output
2	PGND	Power GND
3	PGND	Power GND
4	+OUT_L	Left Channel Positive Output
5	PVDD	Power VDD
6	$\overline{\text{MUTE}}$	Mute Control Input (active low), pull-up
7	VDD	Analog VDD
8	INL	Left Channel Input
9	NC	No Connect
10	VREF	Internal analog reference, connect a bypass capacitor from VREF to GND
11	NC	No Connect
12	NC	No Connect
13	DN	Volume down Control (active low)
14	UP	Volume up Control (active low)
15	RST	Volume Controller Reset (active low)
16	NC	No Connect
17	INR	Right Channel Input
18	GND	Analog GND
19	$\overline{\text{SHDN}}$	Shutdown Control Input (active low), pull-down
20	PVDD	Power VDD
21	+OUT_R	Right Channel Positive Output
22	PGND	Power GND
23	PGND	Power GND
24	-OUT_R	Right Channel Negative Output

## Functional Block Diagram

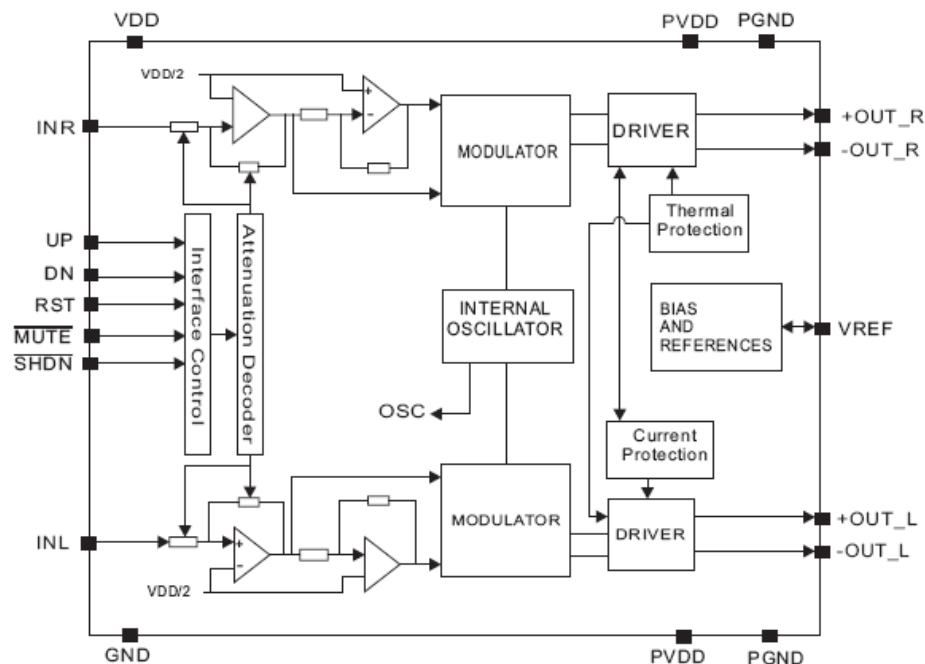

### Absolute Maximum Ratings (@T<sub>A</sub> = +25°C, unless otherwise specified.)

These are stress ratings only and functional operation is not implied. Exposure to absolute maximum ratings for prolonged time periods may affect device reliability. All voltages are with respect to ground.

Parameter	Rating	Unit
Supply Voltage at No Input Signal	6.0	V
Input Voltage	-0.3 to V <sub>DD</sub> +0.3	
Maximum Junction Temperature	150	°C
Storage Temperature	-65 to +150	
Soldering Temperature	300, 5sec	

### Recommended Operating Conditions (@T<sub>A</sub> = +25°C, unless otherwise specified.)

Parameter	Rating	Unit
Supply Voltage Range	2.2 to 5.5	V
Ambient Temperature Range	-40 to +85	°C
Junction Temperature Range	-40 to +125	°C

### Thermal Information

Parameter	Package	Symbol	Max	Unit
Thermal Resistance (Junction to Ambient)	SSOP-24	θ <sub>JA</sub>	96	°C/W

**Electrical Characteristics** (@T<sub>A</sub> = +25°C, V<sub>DD</sub> = 5V, Gain = 18dB, R<sub>L</sub> = 8Ω, unless otherwise specified.)

Parameter	Symbol	Test Conditions	Min	Typ	Max	Units	
Supply Voltage Range	V <sub>DD</sub>		2.2		5.5	V	
Quiescent Current	I <sub>Q</sub>	No Load		7	15	mA	
		R <sub>L</sub> = 8Ω		8			
		R <sub>L</sub> = 4Ω		8.5			
Mute Current	I <sub>MUTE</sub>	V <sub>MUTE</sub> = 0V		2.5	4	mA	
Shutdown Current	I <sub>SHDN</sub>	V <sub>SHDN</sub> = 0V		0.5	10	μA	
SHDN Input High	V <sub>SH</sub>		1.2			V	
SHDN Input Low	V <sub>SL</sub>				0.5		
MUTE Input High	V <sub>MH</sub>		1.2			V	
MUTE Input Low	V <sub>ML</sub>				0.5		
Output Offset Voltage	V <sub>OS</sub>	No Load		120	300	mV	
Drain-Source On-State Resistance	R <sub>DS(ON)</sub>	I <sub>DS</sub> = 0.5A	PMOSFET		0.3	0.40	Ω
			N MOSFET		0.22	0.35	
Output Power	P <sub>O</sub>	f = 1kHz	R <sub>L</sub> = 8Ω, THD = 1%	1.1	1.3		W
			R <sub>L</sub> = 8Ω, THD = 10%	1.5	1.7		
			R <sub>L</sub> = 4Ω, THD = 1%	1.9	2.1		
			R <sub>L</sub> = 4Ω, THD = 10%	2.8	3.0		
Total Harmonic Distortion Plus Noise	THD+N	R <sub>L</sub> = 8Ω, P <sub>O</sub> = 0.5W		0.19		%	
		R <sub>L</sub> = 8Ω, P <sub>O</sub> = 1.0W		0.22			
		R <sub>L</sub> = 4Ω, P <sub>O</sub> = 1.0W		0.17			
		R <sub>L</sub> = 4Ω, P <sub>O</sub> = 2.0W		0.25			
Power Supply Ripple Rejection	PSRR	No Input, f = 1kHz, V <sub>PP</sub> = 200mV	45	55		dB	
Channel Separation	CS	P <sub>O</sub> = 1W, R <sub>L</sub> = 4Ω	60	80		dB	
Oscillator Frequency	f <sub>OSC</sub>		170	210	250	kHz	
Efficiency	η	P <sub>O</sub> = 1.7W, f = 1kHz, R <sub>L</sub> = 8Ω	85	89		%	
		P <sub>O</sub> = 3.0W, f = 1kHz, R <sub>L</sub> = 4Ω	80	83		%	
Signal Noise Ratio	SNR	f = 22 to 22kHz THD = 1%	R <sub>L</sub> = 4Ω		85	dB	
			R <sub>L</sub> = 8Ω		87	dB	
Under Voltage Lock-Out	UVLO			1.95		V	
Over Temperature Protection	OTP			150		°C	
Over Temperature Hysteresis	OTH			60		°C	

**Typical Performance Characteristics** (@ $T_A = +25^\circ\text{C}$ , unless otherwise specified.)

1. THD+N vs Output Power  
 $R_L=4\Omega$ , Gain = 18dB

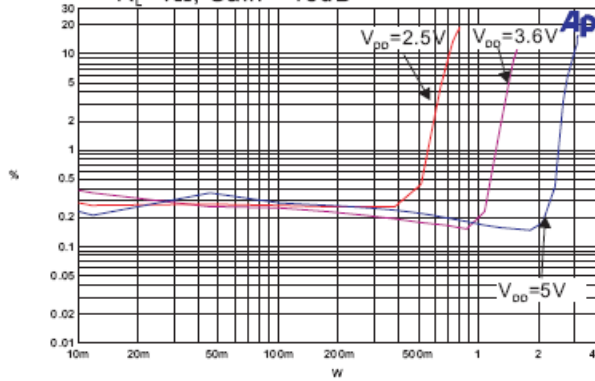

2. THD+N vs Output Power  
 $R_L=8\Omega$ , Gain = 18dB

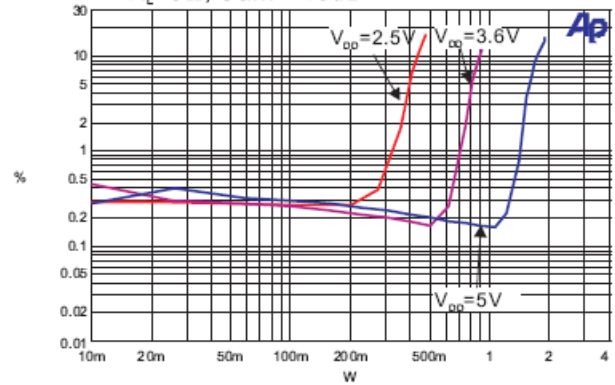

3. THD+N vs Output Power  
 $V_{DD}=5V$ ,  $R_L=4\Omega$ , Gain = 18dB

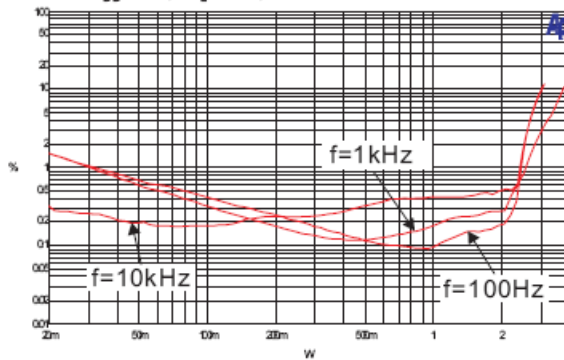

4. THD+N vs Output Power  
 $V_{DD}=5V$ ,  $R_L=8\Omega$ , Gain = 18dB

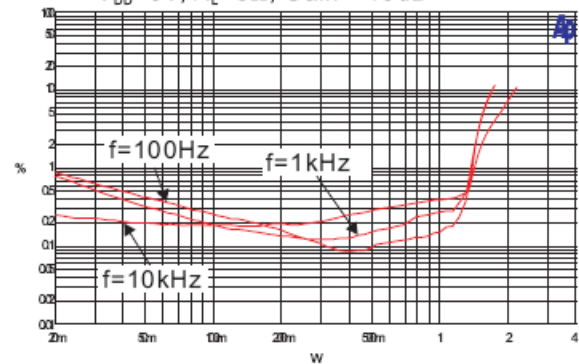

5. THD+N vs Frequency  
 $V_{DD}=5V$ ,  $R_L=4\Omega$ , Gain = 18dB

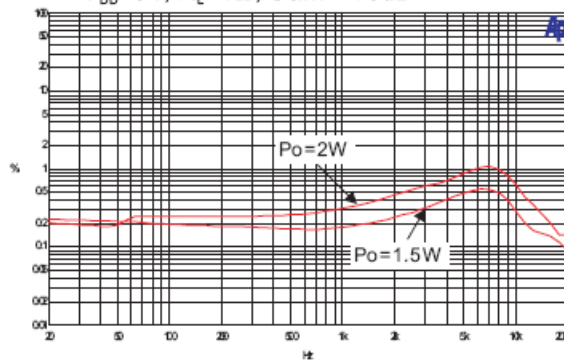

6. THD+N vs Frequency  
 $V_{DD}=5V$ ,  $R_L=8\Omega$ , Gain = 18dB

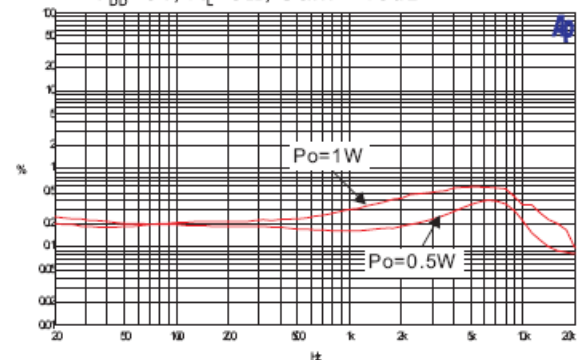

**Typical Performance Characteristics** (cont.) (@ $T_A = +25^\circ\text{C}$ , unless otherwise specified.)

7. THD+N vs. Frequency  
 $P_o=0.8\text{W}, R_L=4\Omega, \text{Gain}=18\text{dB}$

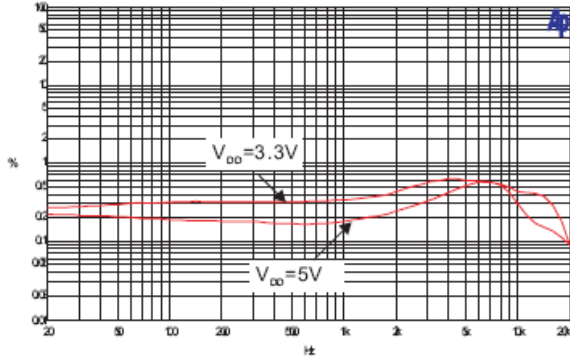

8. THD+N vs. Frequency  
 $P_o=0.1\text{W}, R_L=8\Omega, \text{Gain}=18\text{dB}$

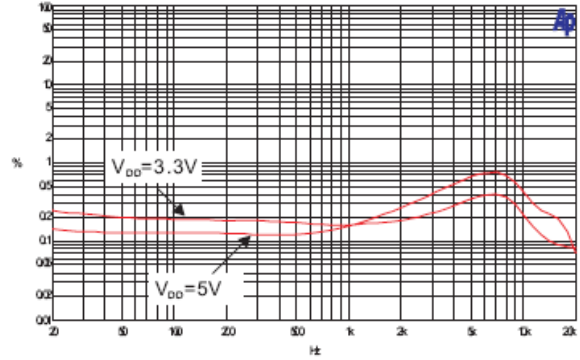

9. Frequency response  
 $V_{DD}=5\text{V}, \text{Gain}=18\text{dB}$

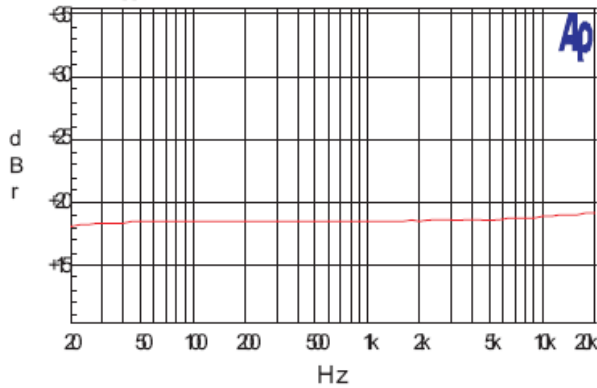

10. Power Supply Ripple Rejection VS Frequency  
 $V_{DD}=5\text{V}$  with 200mVpp Ripple

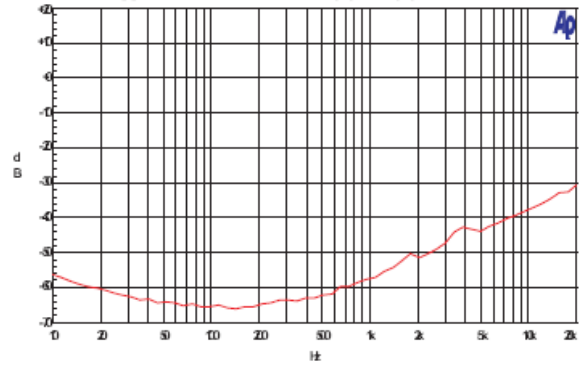

11. FFT of Noise Output  
 $V_{DD}=5\text{V}, \text{Gain}=18\text{dB}$

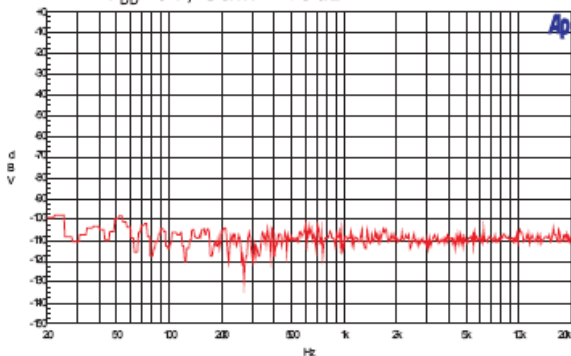

12. Channel Separation  
 $V_{DD}=5\text{V}, R_L=4\Omega, P_o=1.0\text{W}, \text{Gain}=18\text{dB}$

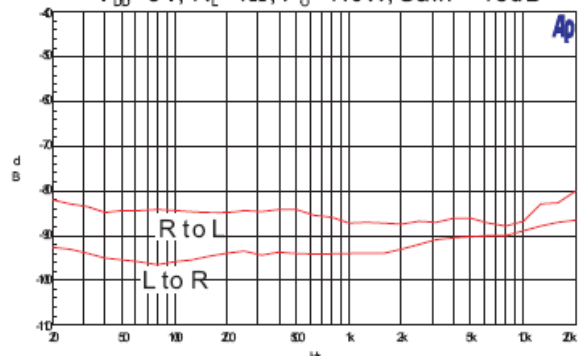

**Typical Performance Characteristics** (cont.) (@T<sub>A</sub> = +25°C, unless otherwise specified.)

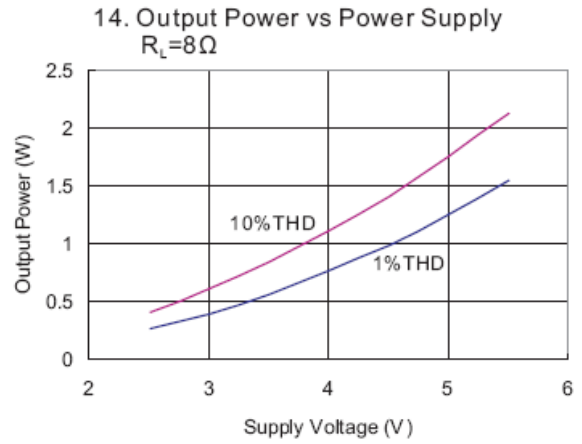
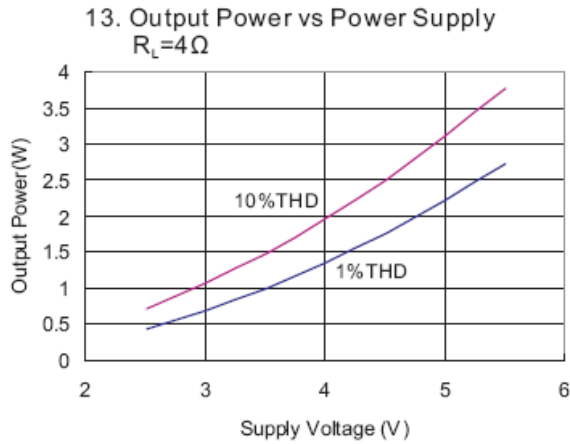

**Gain Setting (V<sub>DD</sub> = 5V)**

Step	Gain (dB)	Step	Gain (dB)	Step	Gain (dB)	Step	Gain (dB)
1	-75.0	17	4.8	33	11.2	49	17.6
2	-39.7	18	5.1	34	11.6	50	18.0
3	-34.0	19	5.5	35	12.0	51	18.4
4	-28.2	20	5.9	36	12.3	52	18.8
5	-22.4	21	6.3	37	12.7	53	19.2
6	-16.5	22	6.7	38	13.2	54	19.6
7	-10.5	23	7.1	39	13.6	55	20.0
8	-8.0	24	7.5	40	14.0	56	20.4
9	-5.5	25	7.9	41	14.4	57	20.9
10	-2.9	26	8.3	42	14.8	58	21.3
11	-0.4	27	8.7	43	15.2	59	21.7
12	1.1	28	9.1	44	15.6	60	22.1
13	2.6 (Note 1)	29	9.6	45	16.0	61	22.5
14	3.6	30	10.0	46	16.4	62	22.9
15	4.0	31	10.4	47	16.8	63	23.4
16	4.4	32	10.7	48	17.2	64	23.8

Note: 1. Power on gain or gain after reset. Gain could have 1dB deviation device to device.

## Application Information

### Maximum Gain

As shown in block diagram (Page 2), the PAM8803 has two internal amplifier stages. The first stage's gain is externally configurable, while the second stage's is internally fixed in a fixed-gain, inverting configuration. The closed-loop gain of the first stage is set by selecting the ratio of  $R_F$  to  $R_J$  while the second stage's gain is fixed at  $2x$ . Consequently, the differential gain for the IC is:

$$A_{VD} = 20 \cdot \log [2 \cdot (R_F/R_J)]$$

The PAM8803 sets maximum  $R_F = 218k\Omega$  minimum  $R_J = 27k\Omega$ , thus the maximum closed gain is 24dB.

### Digital Volume Control (DVC)

The PAM8803 features a digital volume control which consists of the UP, DN and RST pins. An internal clock is used where the clock frequency value is determined from the following formula:

$$f_{CLK} = f_{OSC} / 2^{13}$$

The oscillator frequency  $f_{OSC}$  value is 200kHz typical, with  $\pm 20\%$  tolerance. The DVC's clock frequency is 33Hz (cycle time) typical.

Volume changes are then effected by toggling either the UP or DN pins with a logic low. After a period of 3.5 clocks pulses with either the UP or DN pins held low, the volume will change to the next specified step, either UP or DN, and followed by a short delay. This delay decreases the longer the line is held low, eventually reaching a delay of zero. The delay allows the user to pull the UP or DN terminal low once for one volume change, or hold down to ramp several volume changes. The delay is optimally configured for push button volume control.

If either the UP or DN pin remains low after the first volume transition the volume will change again, but this time after 9.5 clock pulses. The followed transition occurs at 2 clock pulses for each volume transition. This is intended to provide the user with a volume control that pauses briefly after initial application, and then slowly increases the rate of volume change as it is continuously applied. This cycle is shown in the timing diagram shown in Figure 1.

There are 64 discrete gain settings ranging from +24dB maximum to -75dB minimum. Upon device power on or applied a logic low to the RST pin, the amplifier's gain is set to a default value of 2.6dB. However, when coming out of mute mode, the PAM8803 will revert back to its previous gain setting. Volume levels for each step vary and are specified in Gain Setting table on Page 7.

If both the UP and DN pins are held high, no volume change will occur. Trigger points for the UP and DN pins are at 70% of  $V_{DD}$  minimum for a logic high, and 20% of  $V_{DD}$  maximum for a logic low. It is recommended, however, to toggle UP and DN between  $V_{DD}$  and GND for best performance.

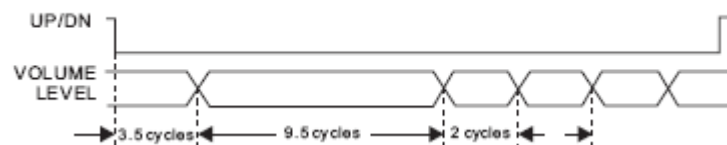

Figure 1. Timing Diagram

### Mute Operation

The MUTE pin is an input for controlling the output state of the PAM8803. A logic low on this pin disables the outputs, and a logic high on this pin enables the outputs. This pin may be used as a quick disable or enable of the outputs without a volume fade. Quiescent current is listed in the electrical characteristic table. The MUTE pin can be left floating due to the pull-up internal.

### Shutdown Operation

In order to reduce power consumption while not in use, the PAM8803 contains shutdown circuitry that is used to turn off the amplifier's bias circuitry. This shutdown feature turns the amplifier off when logic low is placed on the SHDN pin. By switching the SHDN pin connected to GND, the PAM8803 supply current draw will be minimized in idle mode. The SHDN pin cannot be left floating due to the pull-down internal.



## Application Information (cont.)

### Power Supply Decoupling

The PAM8803 is a high performance CMOS audio amplifier that requires adequate power supply decoupling to ensure the output THD and PSRR are as low as possible. Power supply decoupling is affecting low frequency response. Optimum decoupling is achieved by using two capacitors of different types that target different types of noise on the power supply leads. For higher frequency transients, spikes, or digital hash on the line, a good low equivalent-series-resistance (ESR) ceramic capacitor, typically 1.0 $\mu$ F, placed as close as possible to the device  $V_{DD}$  terminal works best. For filtering lower-frequency noise signals, a larger capacitor of 10 $\mu$ F (ceramic) or greater placed near the audio power amplifier is recommended.

### Input Capacitor ( $C_J$ )

Large input capacitors are both expensive and space hungry for portable designs. Clearly, a certain sized capacitor is needed to couple in low frequencies without severe attenuation. But in many cases the speakers used in portable systems, whether internal or external, have little ability to reproduce signals below 100Hz to 150Hz. Thus, using a large input capacitor may not increase actual system performance. In this case, input capacitor ( $C_J$ ) and input resistance ( $R_J$ ) of the amplifier form a high-pass filter with the corner frequency determined equation below,

$$f_c = \frac{1}{2\pi R_J C_J}$$

In addition to system cost and size, click and pop performance is affected by the size of the input coupling capacitor,  $C_J$ . A larger input coupling capacitor requires more charge to reach its quiescent DC voltage (nominally 1/2  $V_{DD}$ ). This charge comes from the internal circuit via the feedback and is apt to create pops upon device enable. Thus, by minimizing the capacitor size based on necessary low frequency response, turn-on pops can be minimized.

### Analog Reference Bypass Capacitor ( $C_{BYP}$ )

The Analog Reference Bypass Capacitor ( $C_{BYP}$ ) is the most critical capacitor and serves several important functions. During start-up or recovery from shutdown mode,  $C_{BYP}$  determines the rate at which the amplifier starts up. The second function is to reduce noise produced by the power supply caused by coupling into the output drive signal. This noise is from the internal analog reference to the amplifier, which appears as degraded PSRR and THD+N.

Bypass capacitor ( $C_{BYP}$ ) values of 0.47 $\mu$ F to 1.0 $\mu$ F ceramic is recommended for the best THD and noise performance. Increasing the bypass capacitor reduces clicking and popping noise from power on/off and entering and leaving shutdown.

### Under Voltage Lock-Out (UVLO)

The PAM8803 incorporates circuitry designed to detect when the supply voltage is low. When the supply voltage drops to 1.85V or below, the PAM8803 outputs are disable, and the device comes out of this state and starts to normal functional when the supply voltage increases.

### Short Circuit Protection (SCP)

The PAM8803 has short circuit protection circuitry on the outputs that prevents damage to the device during output-to-output and output-to- GND short. When a short circuit is detected on the outputs, the outputs are disable immediately. If the short was removed, the device activates again.

### Over Temperature Protection

Thermal protection on the PAM8803 prevents damage to the device when the internal die temperature exceeds +150°C. There is a 15 degree tolerance on this trip point from device to device. Once the die temperature exceeds the thermal set point, the device outputs are disabled. This is not a latched fault. The thermal fault is cleared once the temperature of the die is reduced by +60°C. This large hysteresis will prevent motor boating sound well and the device begins normal operation at this point with no external system interaction.

### How to Reduce EMI (Electro Magnetic Interference)

A simple solution is to put an additional capacitor 1000 $\mu$ F at power supply terminal for power line coupling if the traces from amplifier to speakers are short (<20cm).

## Application Information (cont.)

### How to Reduce EMI (Electro Magnetic Interference)

Most applications require a ferrite bead filter which shows at Figure 3. The ferrite filter reduces EMI around 1 MHz and higher. When selecting a ferrite bead, choose one with high impedance at high frequencies, but low impedance at low frequencies.

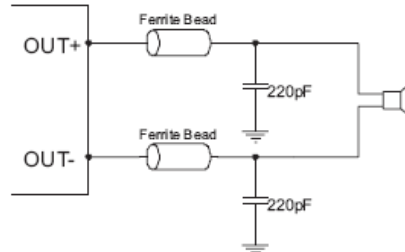

Figure 3. Ferrite Bead Filter to Reduce EMI

### PCB Layout Guidelines

#### Grounding

At this stage it is paramount that we acknowledge the need for separate grounds. Noise currents in the output power stage need to be returned to output noise ground and nowhere else. Were these currents to circulate elsewhere, they may get into the power supply, the signal ground, etc, worse yet, they may form a loop and radiate noise. Any of these instances results in degraded amplifier performance. The logical returns for the output noise currents associated with Class D switching are the respective PGND pins for each channel. The switch state diagram illustrates that PGND is instrumental in nearly every switch state. This is the perfect point to which the output noise ground trace should return. Also note that output noise ground is channel specific. A two channels amplifier has two mutually exclusive channels and consequently must have two mutually exclusive output noise ground traces. The layout of the PAM8803 offers separate PGND connections for each channel and in some cases each side of the bridge. Output noise grounds must tie to system ground at the power in exclusively. Signal currents for the inputs, reference, etc need to be returned to quiet ground. This ground only ties to the signal components and the GND pin. GND then ties to system ground.

#### Power Supply Line

As same to the ground,  $V_{DD}$  and each channel  $PV_{DD}$  need to be separated and tied together at the system power supply. Recommend that all the trace could be routed as short and thick as possible. For the power line layout, just imagine water stream, any barricade placed in the trace (shows in Figure 4) could result in the bad performance of the amplifier.

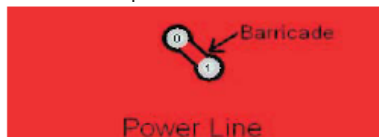

Figure 4

#### Components Placement

The power supply decoupling capacitors need to be placed as close to  $V_{DD}$  and  $PV_{DD}$  pins as possible. The inputs need to be routed away from the noisy trace. The  $V_{REF}$  bypass capacitor also needs to be close to the pin of IC very much.

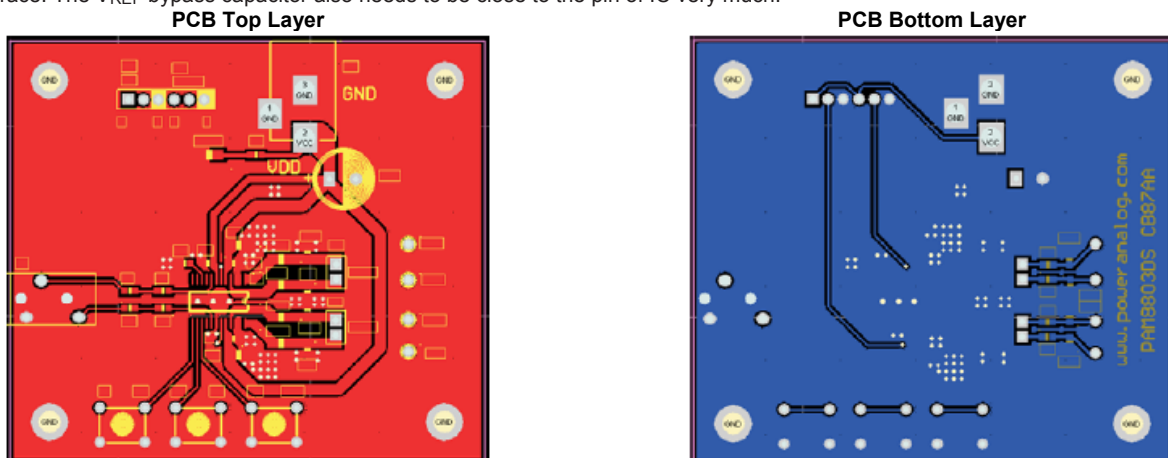
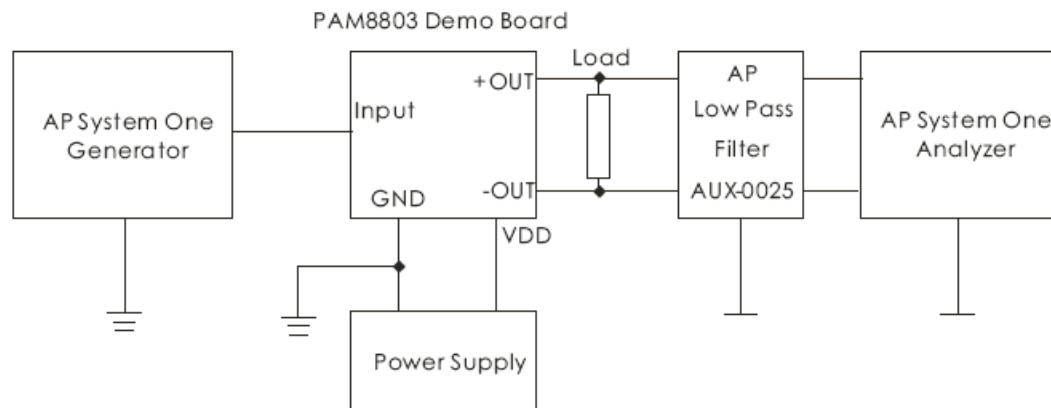

Figure 5. Layout Example

## Application Notice

1. When PAM8803 works without filter, we must connect the speaker before turn on. Else, it will be easy to damage the chip.
2. When PAM8803 works without filter, it will be best that adding a ferrite chip bead at the outgoing line of speaker in order to suppress possible electromagnetic interference .
3. The absolute maximum rating of operation voltage is 6.0V. While using 6V power regulator, even the chip can deliver 4W sine wave with a 4Ω speaker, it is not recommended for long term using due to the heat dissipation. But if the input signal is a music signal, then it can work in long term since the average power output is much less than 4W. When using dry battery cell, we should notice that if the battery cell is 4 new dry batteries or alkaline batteries, even the voltage will be over 6V, it still can work safety. Since the output voltage of the 4 pack of new dry batteries will be reduced very quickly after turn on due to the internal resistance of the battery. There is no dangerous of damaging the chip when playing music or speech, even use 4 new dry batteries. To reduce the effect of the increasing of internal resistance of battery after long term discharging, it is recommended to connect a 1000μF electrolytic capacitor between the power supply and the ground.
4. Because digital volume control has big gain, we can not make input signal too high to cause the clipping of the output signal when increase volume, also it may damage the chip.

## Test Setup for Application Testing



- Notes:
2. The AP AUX-0025 low pass filter is necessary for every class-D amplifier measurement done by AP analyzer.
  3. Two 22 H inductors are used in series with load resistor to emulate the small speaker for efficiency and quiescent current measurement.

**Ordering Information**

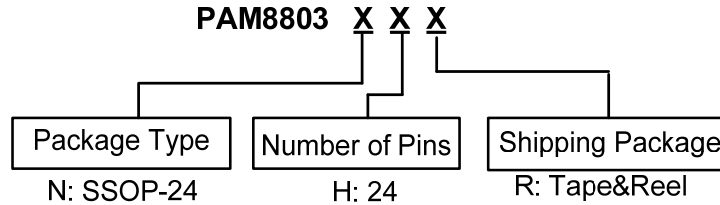

Part Number	Part Marking	Package Type	Standard Package
PAM8803NHR	PAM8803 XXXYWWLL	SSOP-24	2500 Units/Tape&Reel

**Marking Information**

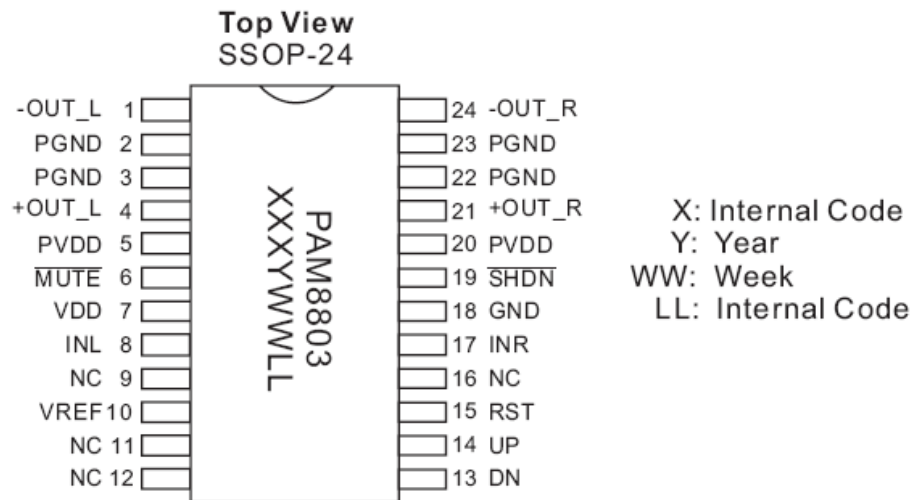

**Package Outline Dimensions** (All dimensions in mm.)

**SSOP-24**

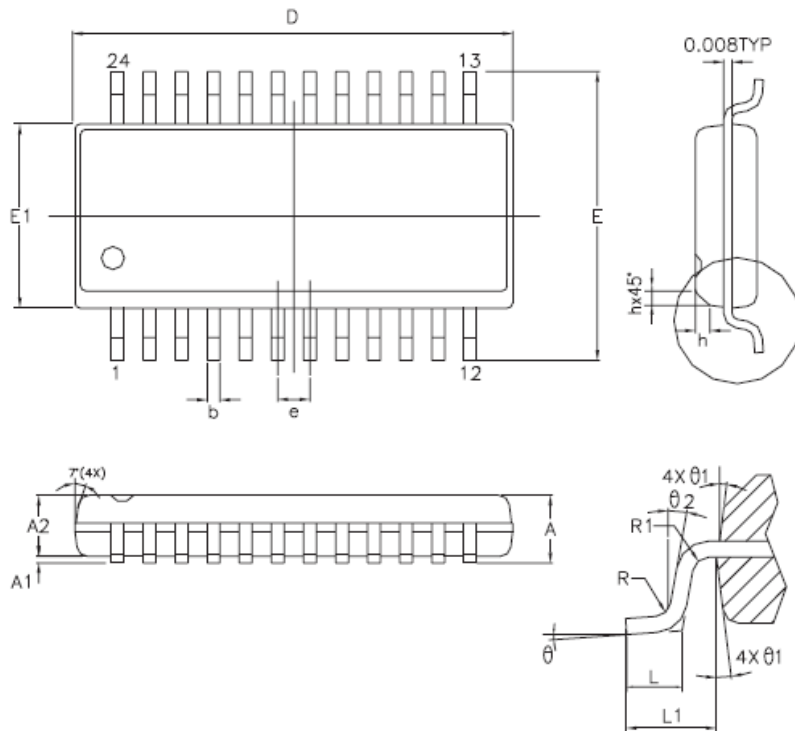

SYMBOLS	MIN.	NOM.	MAX.
A	0.053	0.061	0.069
A1	0.004	-	0.010
A2	0.049	0.057	0.065
b	0.008	0.010	0.012
D	0.335	0.341	0.347
E	0.228	0.236	0.244
E1	0.150	0.154	0.158
e	-	0.025	-
L	0.016	0.033	0.050
L1	0.041 REF		
R	0.003	-	-
R1	0.003	-	-
h	0.010	0.015	0.020
θ	0°	4°	8°
θ1	5°	10°	15°
θ2	0°	-	-

UNIT : INCH

#### IMPORTANT NOTICE

DIODES INCORPORATED MAKES NO WARRANTY OF ANY KIND, EXPRESS OR IMPLIED, WITH REGARDS TO THIS DOCUMENT, INCLUDING, BUT NOT LIMITED TO, THE IMPLIED WARRANTIES OF MERCHANTABILITY AND FITNESS FOR A PARTICULAR PURPOSE (AND THEIR EQUIVALENTS UNDER THE LAWS OF ANY JURISDICTION).

Diodes Incorporated and its subsidiaries reserve the right to make modifications, enhancements, improvements, corrections or other changes without further notice to this document and any product described herein. Diodes Incorporated does not assume any liability arising out of the application or use of this document or any product described herein; neither does Diodes Incorporated convey any license under its patent or trademark rights, nor the rights of others. Any Customer or user of this document or products described herein in such applications shall assume all risks of such use and will agree to hold Diodes Incorporated and all the companies whose products are represented on Diodes Incorporated website, harmless against all damages.

Diodes Incorporated does not warrant or accept any liability whatsoever in respect of any products purchased through unauthorized sales channel. Should Customers purchase or use Diodes Incorporated products for any unintended or unauthorized application, Customers shall indemnify and hold Diodes Incorporated and its representatives harmless against all claims, damages, expenses, and attorney fees arising out of, directly or indirectly, any claim of personal injury or death associated with such unintended or unauthorized application.

Products described herein may be covered by one or more United States, international or foreign patents pending. Product names and markings noted herein may also be covered by one or more United States, international or foreign trademarks.

This document is written in English but may be translated into multiple languages for reference. Only the English version of this document is the final and determinative format released by Diodes Incorporated.

#### LIFE SUPPORT

Diodes Incorporated products are specifically not authorized for use as critical components in life support devices or systems without the express written approval of the Chief Executive Officer of Diodes Incorporated. As used herein:

A. Life support devices or systems are devices or systems which:

1. are intended to implant into the body, or
2. support or sustain life and whose failure to perform when properly used in accordance with instructions for use provided in the labeling can be reasonably expected to result in significant injury to the user.

B. A critical component is any component in a life support device or system whose failure to perform can be reasonably expected to cause the failure of the life support device or to affect its safety or effectiveness.

Customers represent that they have all necessary expertise in the safety and regulatory ramifications of their life support devices or systems, and acknowledge and agree that they are solely responsible for all legal, regulatory and safety-related requirements concerning their products and any use of Diodes Incorporated products in such safety-critical, life support devices or systems, notwithstanding any devices- or systems-related information or support that may be provided by Diodes Incorporated. Further, Customers must fully indemnify Diodes Incorporated and its representatives against any damages arising out of the use of Diodes Incorporated products in such safety-critical, life support devices or systems.

Copyright © 2012, Diodes Incorporated

[www.diodes.com](http://www.diodes.com)