

ZL8800-2CH-DEMO1Z Demonstration Board User Guide

The ZL8800 is a digital power conversion and management IC that combines an efficient step-down DC/DC converter with key power and thermal management functions in a single package. The ZL8800 incorporates compensation-free ChargeMode™ control to achieve single-cycle transient response.

The ZL8800-2CH-DEMO1Z demonstration board is a 6-layer board demonstrating 2 independent 30A synchronous buck converters. Sequencing, tracking, margining, plus other features can be evaluated using this board.

A USB to PMBus™ adapter board is used to connect the demonstration board to a PC. The PMBus command set is accessed by using the Intersil PowerNavigator™ evaluation software from a PC running Microsoft Windows.

Key Features

- 2 independent 30A synchronous buck converters with compensation-free ChargeMode control
- Designed to be easy to use and modify. Optimized for small circuit footprint and dynamic response
- Configurable through PMBus
- V_{IN} range of 6.5V to 14V, V_{OUT} adjustable from 0.54 to 5.5V
- Enable switches and power-good indicators

Ordering Information

PART NUMBER	DESCRIPTION
ZL8800-2CH-DEMO1Z	ZL8800 Demonstration Kit (EVB, USB Adapter, Cable)

Target Specifications

- $V_{IN} = 12V$
- $V_{OUT} = 1.2V/30A$ max and $1.0V/30A$ max
- $f_{SW} = 512kHz$
- Efficiency: 91% at 20A
- Output Ripple: $\pm 1\%$
- Dynamic response: $\pm 1\%$ (50% to 100% to 50% load step, $di/dt = 10A/\mu s$)
- Board temperature: $+25^\circ C$

Functional Description

The ZL8800-2CH-DEMO1Z provides all circuitry required to demonstrate the features of the ZL8800. The ZL8800-2CH-DEMO1Z has a functionally-optimized ZL8800 circuit layout that allows efficient operation up to the maximum output current.

A majority of the features of the ZL8800, such as compensation-free ChargeMode control, soft-start delay and ramp times, supply sequencing, voltage tracking and voltage margining are available on this demonstration board. For voltage tracking and sequencing demonstration, the board can be connected to any other Intersil demonstration board that supports the Digital-DC™ (DDC) bus.

Figure 1 shows a simplified schematic diagram of the ZL8800-2CH-DEMO1Z board.

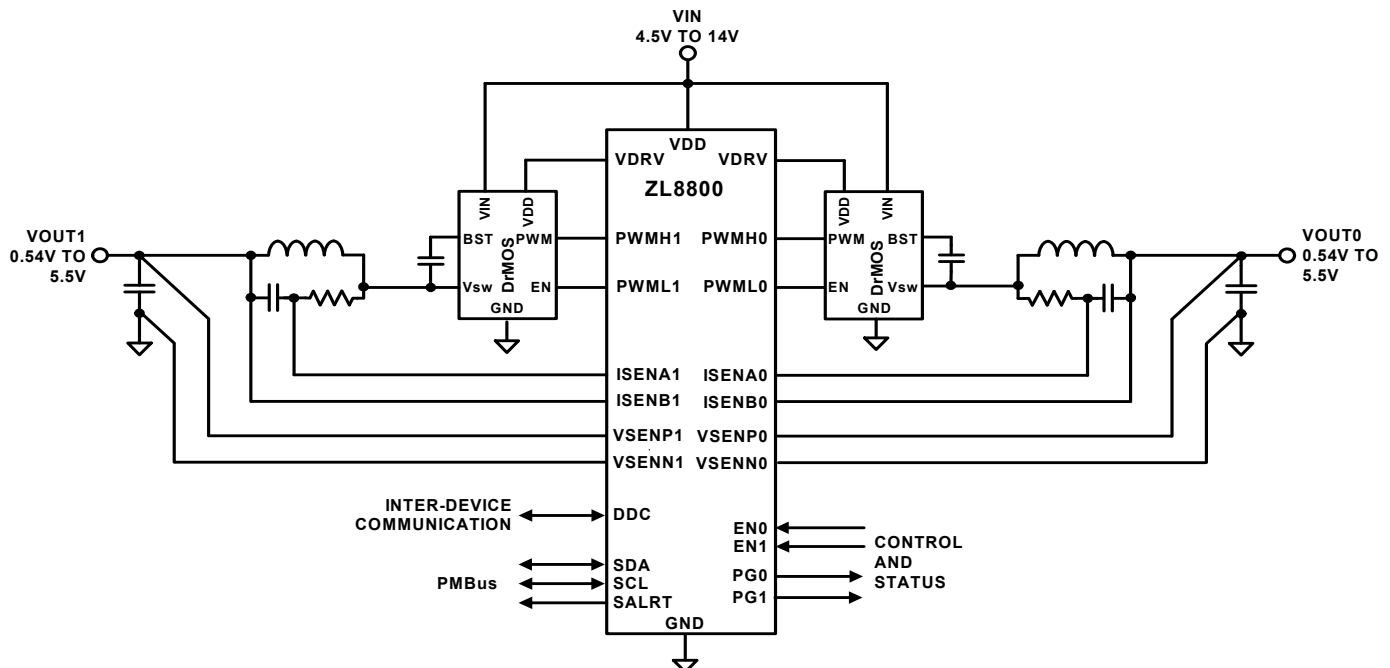

FIGURE 1. ZL8800-2CH-DEMO1Z SIMPLIFIED SCHEMATIC

The hardware enable function is controlled by toggle switches on the ZL8800-2CH-DEMO1Z board. The power-good (PG) LEDs indicate the correct state of PG when external power is applied to the ZL8800-2CH-DEMO1Z board and the corresponding output is functioning properly. The right angle headers at opposite ends of the board are for connecting a USB to PMBus adapter board or for daisy chaining multiple demonstration boards together to build multioutput configurations.

[Figures 2](#) and [3](#) show the detailed demonstration circuit. [Figure 2](#) shows the ZL8800 IC with its minimal component count to realize a 30A output on each buck converter. [Figure 3](#) has interface circuitry unique to the demonstration board that is not typically contained in a user's application circuit. [Figures 4](#) through [10](#) show typical performance data and [Figures 15](#) through [22](#) demonstrate the PCB board layout, which include the board fabrication notes. The default configuration file is shown on [page 6](#), and the Bill of Materials (BOM) is included for reference beginning on [page 5](#).

References

[ZL8800](#) Datasheet, "Dual Channel/Dual Phase PMBus™ ChargeMode Control DC/DC Digital Controller"

Operation

PMBus Operation

The ZL8800 utilizes the PMBus protocol. The PMBus functionality can be controlled via USB from a PC running the PowerNavigator evaluation software in a Windows XP, Windows 7 or Windows 8 operating systems.

Install the evaluation software from the following Intersil website:

<http://www.intersil.com/powernavigator.html>

For board operation, connect the included USB-to-PMBus adapter board to J8 of the ZL8800-2CH-DEMO1Z board labeled "DONGLE". Connect the desired load and an appropriate power supply to the input and connect the included USB cable to the PC running the PowerNavigator evaluation software. Place the ENABLE switches in "DISABLE" and turn on the power.

The evaluation software allows modification of all ZL8800 PMBus parameters. The ZL8800 device on the board has been preconfigured as described in this document, but the user may modify the operating parameters through the evaluation software or by loading a predefined set-up from a configuration file.

The ENABLE switch can then be moved to "ENABLE" and the ZL8800-2CH-DEMO1Z board can be tested. Alternately, the PMBus ON_OFF_CONFIG and OPERATION commands may be used from the PowerNavigator GUI.

Quick Start Guide

Stand-Alone Operation

1. Set ENABLE switch to "DISABLE".
2. Apply load to VOUT0 and/or VOUT1.
3. Connect the USB to PMBus adapter board to J8 (labeled "DONGLE") of ZL8800-2CH-DEMO1Z.
4. Connect supplied USB cable from computer to USB to PMBus adapter board.
5. Connect power supply to VIN (supply turned off).
6. Turn power supply on.
7. Set ENABLE switch to "ENABLE".
8. Monitor ZL8800-2CH-DEMO1Z board operation using an oscilloscope.

USB (PMBus) Operation

1. Set ENABLE switch to "DISABLE".
2. Apply load to VOUT and/or VOUT1.
3. Connect power supply to VIN (supply turned off).
4. Turn power supply on.
5. Connect USB to PMBus adapter board to J8 of ZL8800-2CH-DEMO1Z.
6. Connect supplied USB cable from computer to USB to PMBus adapter board.

Install the PowerNavigator evaluation software from the following Intersil website:

<http://www.intersil.com/powernavigator.html>

7. Set ENABLE switch to "ENABLE".
8. Monitor and configure the ZL8800-2CH-DEMO1Z board using PMBus commands in the evaluation software.
9. Test the ZL8800-2CH-DEMO1Z operation using an oscilloscope and the evaluation software.

ZL8800-2CH-DEMO1Z Board Schematics

ZL8800 DUAL CHANNEL

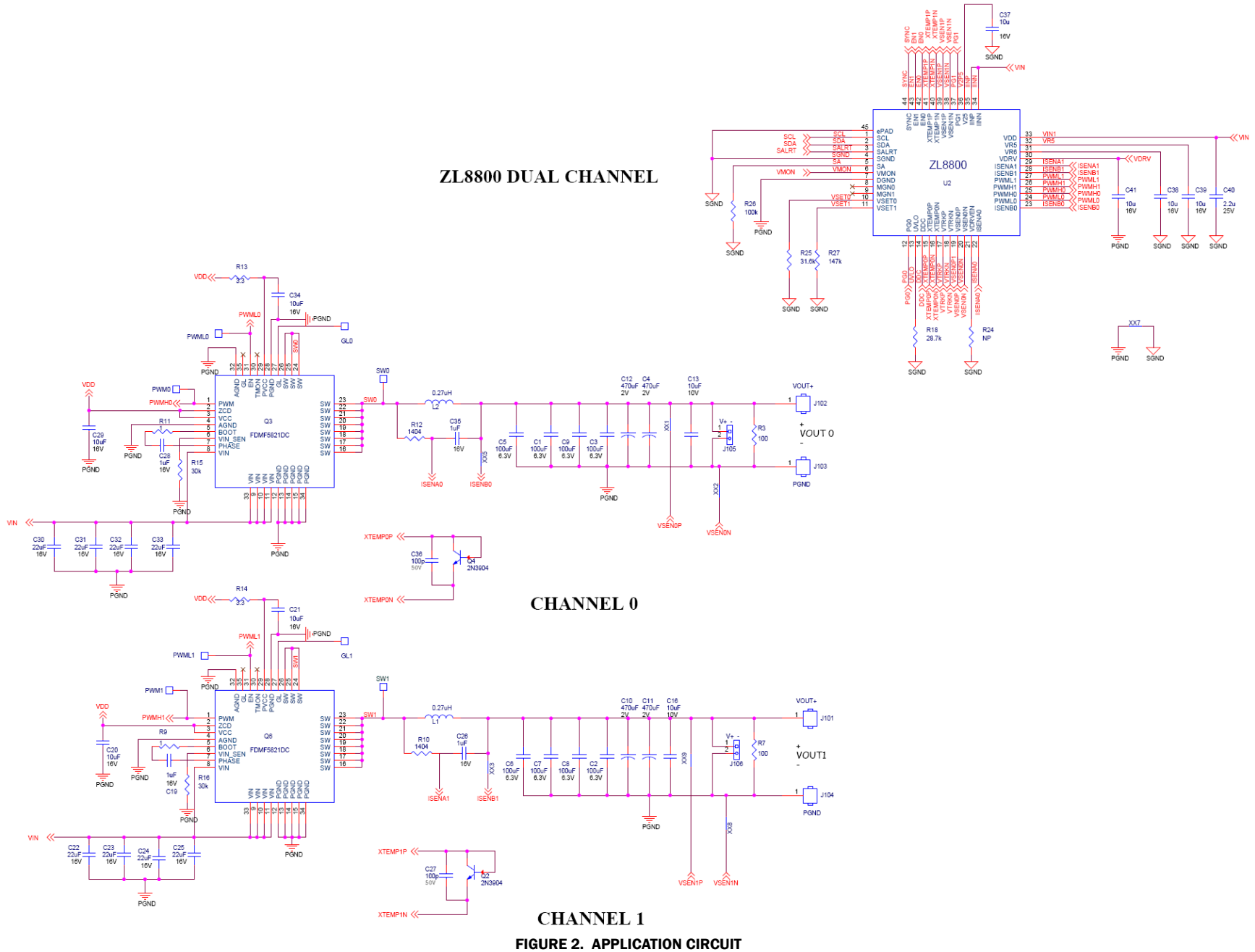
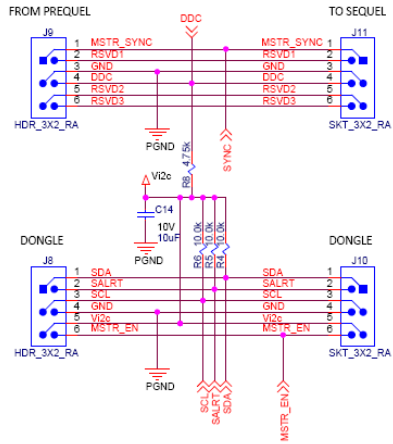

FIGURE 2. APPLICATION CIRCUIT

ZL8800-2CH-DEMO1Z Board Schematics (Continued)

BOARD TO BOARD INTERFACE



POWER GOOD

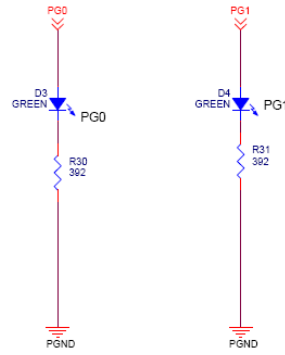

TRACKING

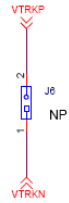

DRIVER SUPPLY

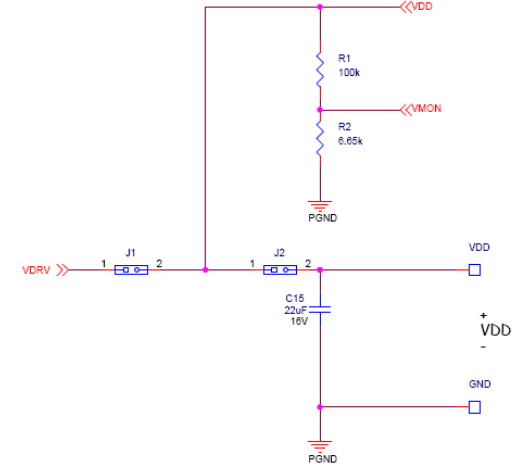

ENABLE

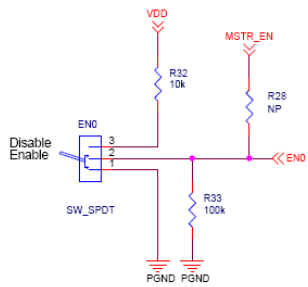

ENABLE

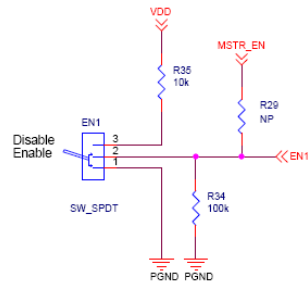

INPUT CONNECTOR

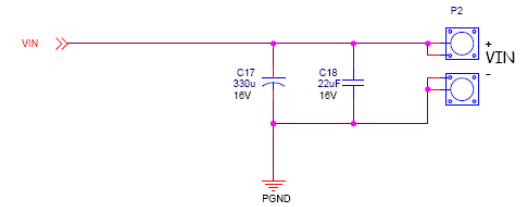

FIGURE 3. ZL8800-2CH-DEMO1Z AUXILIARY CIRCUITRY

Application Note 1877

ZL8800-2CH-DEMO1Z Bill of Materials

QTY	REFERENCE	VALUE	TOL	RATING	TYPE	PCB FOOTPRINT	MFR	PART NUMBER
1	U2	ZL8800	-	14V	-	MLF44_7X7_XX	Intersil	ZL8800ALAFK
8	C1, C2, C3, C5, C6, C7, C8, C9	100µF	20%	6.3V	X5R	SM1210	Taiyo Yuden	JMK325BJ107MY-T
4	C4, C10, C11, C12	470µF	20%	2V	AL	SM7343P	Panasonic	EEF-SX0D471E4
4	C13, C20, C29, C16	10µF	10%	10V	X5R	SM0805	Taiyo Yuden	LMK212B7106KG-TD
9	C18, C22, C23, C24, C25, C30, C31, C32, C33	22µF	20%	16V	X5R	SM1206	Murata	GRM31CR61C226ME15L
1	C17	330µ	20%	16V	AL POLY	SM_CAP_10.5X10.5	United Chemi	APXA160ARA331MJC0G
4	C19, C26, C28, C35	1µF	10%	16V	X7R	SM0603	TDK	C1608X7R1C105K
2	C27, C36	100p	5%	50V	NPO	SM0402_WSS	Murata	GRM1555C1H101JZ01D
6	C38, C39, C41, C37, C21, C34	10µ	20%	16V	X5R	SM0603	Taiyo Yuden	EMK107BBJ106MA-T
1	C40	2.2µ	10%	25V	X5R	SM0805	Murata	GRM21BR71E225KA73L
2	L1, L2	0.27µH	-	35.5A	FERRITE	IND_SLC1175	Coil Craft	SLC1175-271ME_
2	Q3, Q6	FDMF5821	-	60A/20V	DR MOS	PQFN31_5X5_P5S	Fairchild	FDMF5821DC
2	Q2, Q4	2N3904	-	40V	NPN	SOT-23	ON Semi	MMBT3904LT1G
2	R1, R26	100k	1%	100mW	THK FILM	SM0603	Panasonic	ERJ-3EKF1003V
1	R2	6.65k	1%	100mW	THK FILM	SM0603	Panasonic	ERJ-3EKF6651V
2	R3, R7	100	1%	100mW	THK FILM	SM0805	Panasonic	ERJ-6ENF1000V
2	R9, R11	1	5%	100mW	THK FILM	SM0603	Rohm	MCR03EZPJ1R0
2	R10, R12	1.40k	1%	100mW	THK FILM	SM0603	Panasonic	ERJ-3EKF1401V
1	R18	28.7k	1%	100mW	THK FILM	SM0402	Panasonic	ERJ-3EKF2872V
1	R25	31.6k	1%	100mW	THK FILM	SM0603	Panasonic	ERJ-3EKF3162V
1	R27	147k	1%	100mW	THK FILM	SM0603	Panasonic	ERJ-3EKF1473V
2	R14, R13	3.3Ω	5%	100mW	THK FILM	SM0603	Panasonic	ERJ-3GEYJ3R3V
2	R15, R16	30k	5%	100mW	THK FILM	SM0603	Panasonic	ERJ-3GEYJ303V
DEMONSTRATION BOARD SPECIFIC AUXILIARY PARTS BILL OF MATERIALS								
1	VDD	Terminal	-	Red	Test Point	TP_036H_SSREF	Keystone	5000
1	GND	Terminal	-	Black	Test Point	TP_036H_SSREF	Keystone	5001
2	D3, D4	GREEN	-	2V, 20mA	LED	SM0805	Chicago Mini	CMD17-21VGC/TR8
2	EN1, EN0	SW_SPDT	-	-	PCB VERT	SW_TOG_SPDT	NKK	G12AP
4	J1, J2, J105, J106	2 POS	-	-	VERT	SIP2/100	Samtec	TSW-102-07-L-S
1	J6	Not Used	-	-	-	-	-	-
2	J8, J9	Header	-	-	RA	HDRM3DUALRA	Samtec	TSW-103-08-T-D-RA
2	J10, J11	Socket	-	-	RA	HDRF3DUALRA	Samtec	SSQ-103-02-T-D-RA
4	J101, J102, J103, J104	Terminal	-	-	-	JACK_F_175	Burndy	KPA8CTP
2	P2	Banana Jack	-	15A	-	JACK_F_NI_2P	Emerson	108-0740-001
2	R30, R31	392	1%	100mW	THK FILM	SM0603	Yageo	RC0603FR-07393RL
1	C15	22µF	20%	16V	X5R	SM1206	Murata	GRM31CR61C226ME15L
5	R4, R5, R6, R32, R35	10.0k	1%	63mW	THK FILM	SM0603	Panasonic	ERJ-2RKF1002X
2	R33, R34	100k	1%	100mW	THK FILM	SM0603	Panasonic	ERJ-3EKF1003V
3	R24, R28, R29	Not Used	-	-	-	SM0603	-	-
1	R8	4.75k	1%	100mW	THK FILM	SM0603	Panasonic	ERJ-2RKF4751X
1	C14	10µF	10%	10V	X5R	SM1206	Murata	GRM31CR61C106ME15L

Configuration File

The following text is loaded into the ZL8800 device on the ZL8800-2CH-DEMO1Z as default settings. Each PMBus command is loaded via the PowerNavigator software. The # symbol is used for a comment line.

Initialize device to factory settings

```
RESTORE_FACTORY
STORE_DEFAULT_ALL
STORE_USER_ALL
```

```
### Begin Default Store
RESTORE_DEFAULT_ALL
```

Global commands

PAGE 0 commands

```
PAGE 0x0
VOUT_MAX 0x4000 # 2 V
IOUT_CAL_GAIN 0xb11e # 0.279 mV/A
IOUT_OC_FAULT_LIMIT 0xe370 # 55 A
IOUT_UC_FAULT_LIMIT 0xe490 # -55 A
USER_CONFIG 0x786
INDUCTOR 0xb114 # 0.27 uH
TEMPCO_CONFIG 0xa7
DDC_GROUP 0x0
IOUT_AVG_OC_FAULT_LIMIT 0xe230 # 35 A
IOUT_AVG_UC_FAULT_LIMIT 0xe5d0 # -35 A
MFR_VMON_OV_FAULT_LIMIT 0xcb00 # 6 V
MFR_VMON_UV_FAULT_LIMIT 0xca00 # 4 V
```

PAGE 1 commands

```
PAGE 0x1
VOUT_COMMAND 0x2000 # 1 V
VOUT_MAX 0x4000 # 2 V
VOUT_MARGIN_HIGH 0x219a # 1.05 V
VOUT_MARGIN_LOW 0x1e66 # 0.95 V
IOUT_CAL_GAIN 0xb11e # 0.279 mV/A
VOUT_OV_FAULT_LIMIT 0x235c # 1.105 V
VOUT_UV_FAULT_LIMIT 0x1ca4 # 0.895 V
IOUT_OC_FAULT_LIMIT 0xe370 # 55 A
IOUT_UC_FAULT_LIMIT 0xe490 # -55 A
POWER_GOOD_ON 0x1ccd # 0.9 V
USER_CONFIG 0x7a6
INDUCTOR 0xb114 # 0.27 uH
TEMPCO_CONFIG 0xa7
IOUT_AVG_OC_FAULT_LIMIT 0xe230 # 35 A
IOUT_AVG_UC_FAULT_LIMIT 0xe5d0 # -35 A
MFR_VMON_OV_FAULT_LIMIT 0xcb00 # 6 V
MFR_VMON_UV_FAULT_LIMIT 0xca00 # 4 V
```

```
STORE_DEFAULT_ALL
### End Default Store
```

```
### Begin User Store
RESTORE_USER_ALL
```

Global commands

PAGE 0 commands

```
PAGE 0x0
```

PAGE 1 commands

```
PAGE 0x1
```

```
STORE_USER_ALL
### End User Store
```

Application Note 1877

Measured Data

The following data was acquired using a ZL8800-2CH-DEMO1Z Rev B demonstration board.

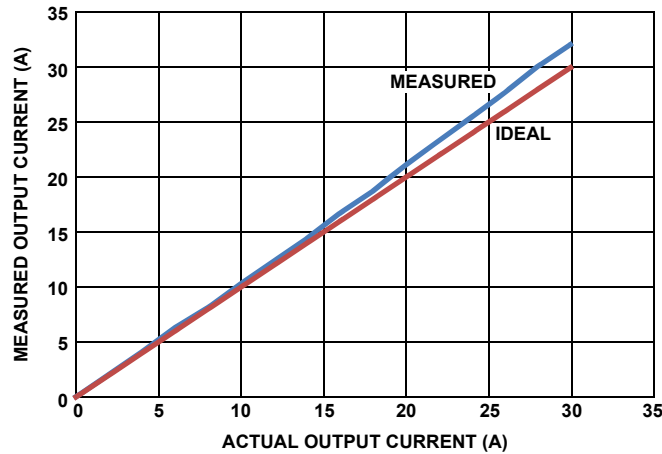

FIGURE 4. OUTPUT CURRENT MEASUREMENT ACCURACY

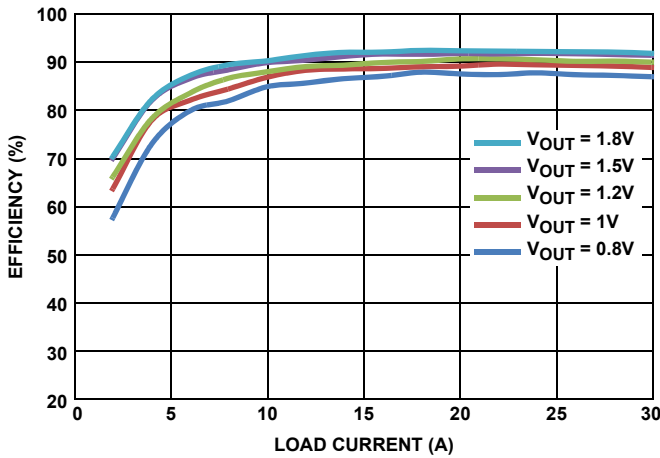

FIGURE 5. EFFICIENCY, $V_{IN} = 12V$, $f_{SW} = 300kHz$

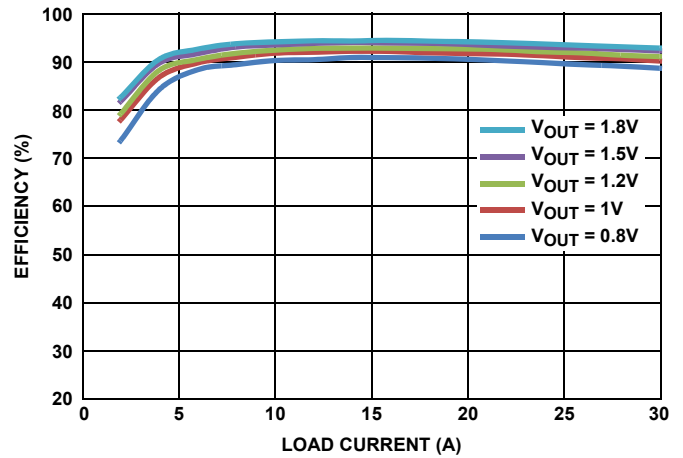

FIGURE 6. EFFICIENCY, $V_{IN} = 5V$, $f_{SW} = 300kHz$

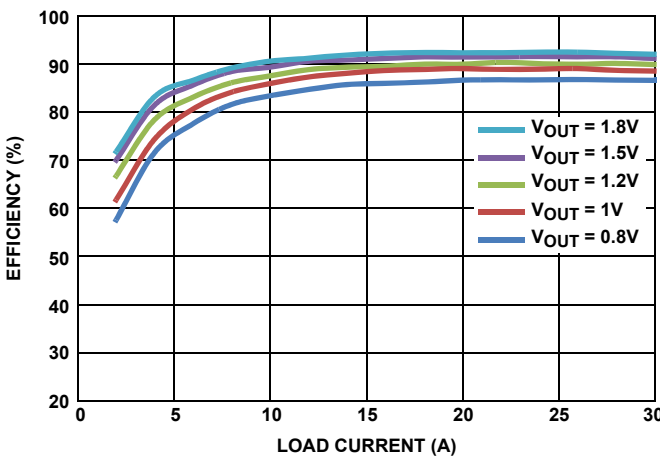

FIGURE 7. EFFICIENCY, $V_{IN} = 12V$, $f_{SW} = 400kHz$

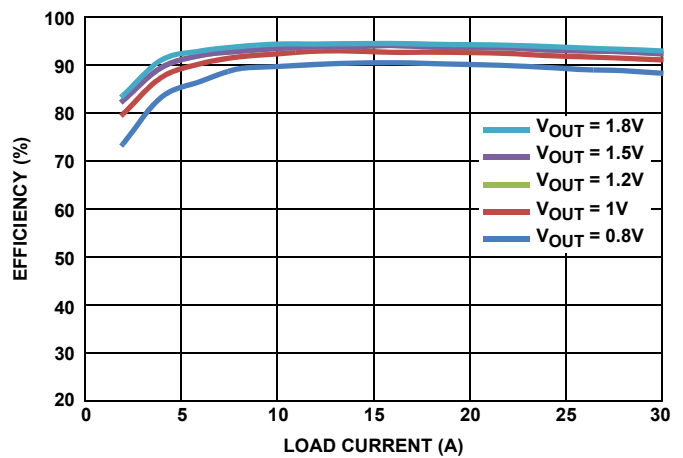

FIGURE 8. EFFICIENCY, $V_{IN} = 5V$, $f_{SW} = 400kHz$

Application Note 1877

Measured Data

The following data was acquired using a ZL8800-2CH-DEMO1Z Rev B demonstration board. (Continued)

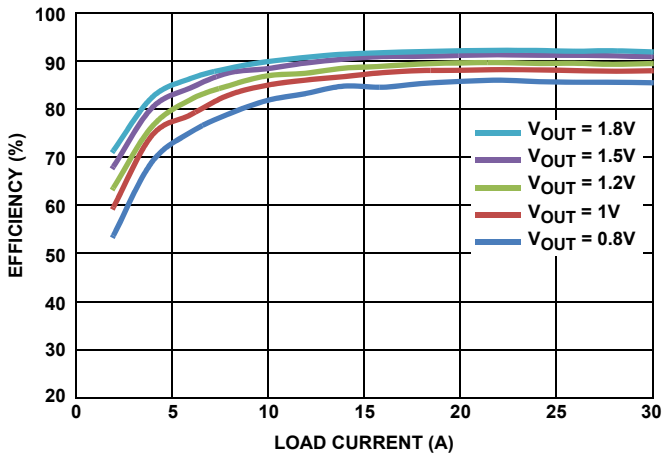

FIGURE 9. EFFICIENCY, $V_{IN} = 12V$, $f_{SW} = 516kHz$

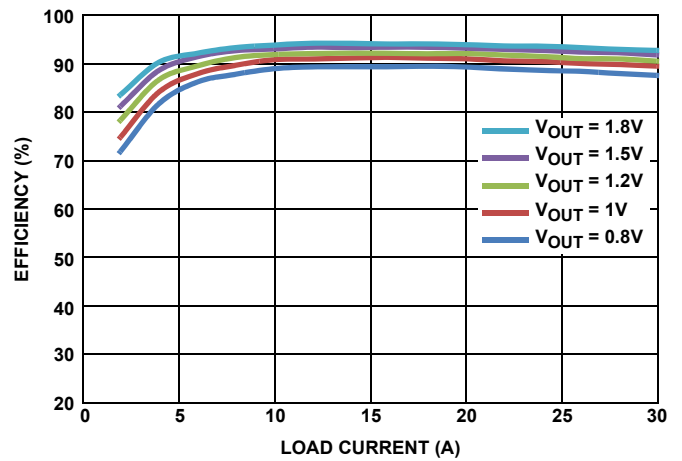

FIGURE 10. EFFICIENCY, $V_{IN} = 5V$, $f_{SW} = 516kHz$



FIGURE 11. RAMP UP

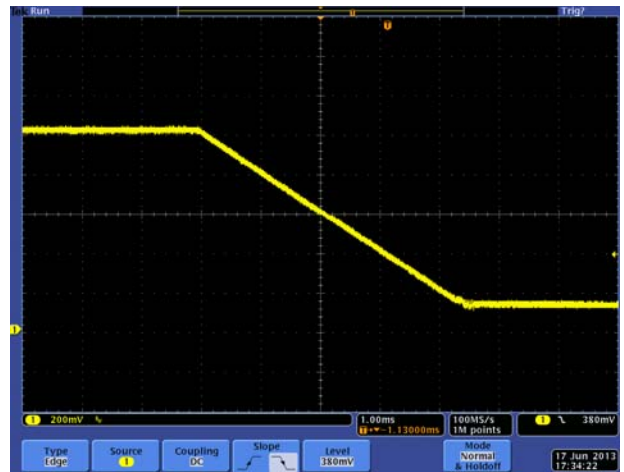

FIGURE 12. RAMP DOWN

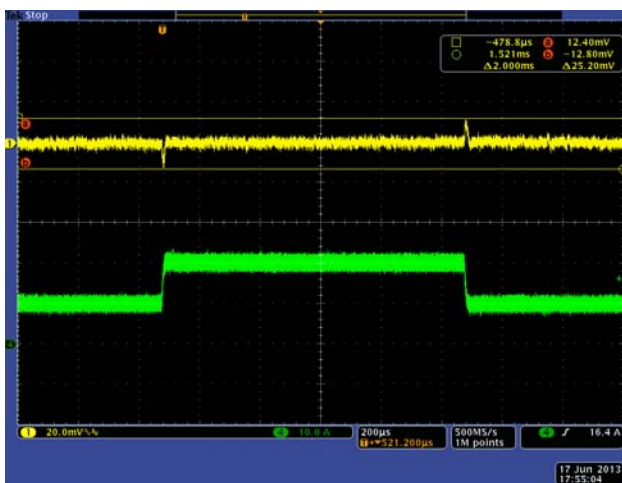

FIGURE 13. STEP RESPONSE, 10A TO 20A AT 5A/ μ s, AS CR = 1000
TOTAL DEVIATION WINDOW 25mV = 2.5%

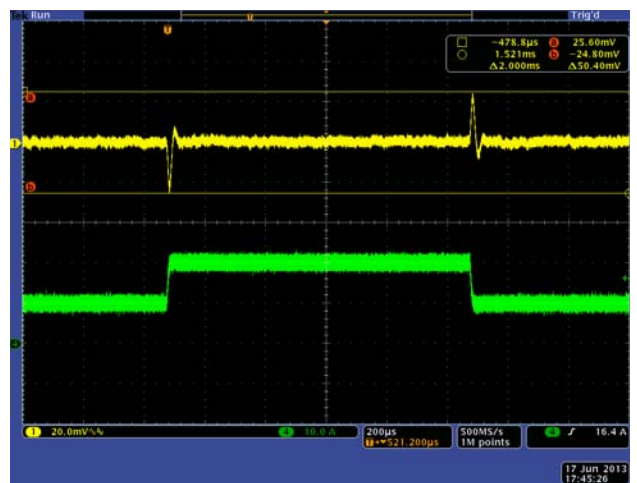

FIGURE 14. STEP RESPONSE, 10A TO 20A AT 5A/ μ s, AS CR = 400
TOTAL DEVIATION WINDOW 50mV = 5%

ZL8800-2CH-DEMO1Z Board Layout

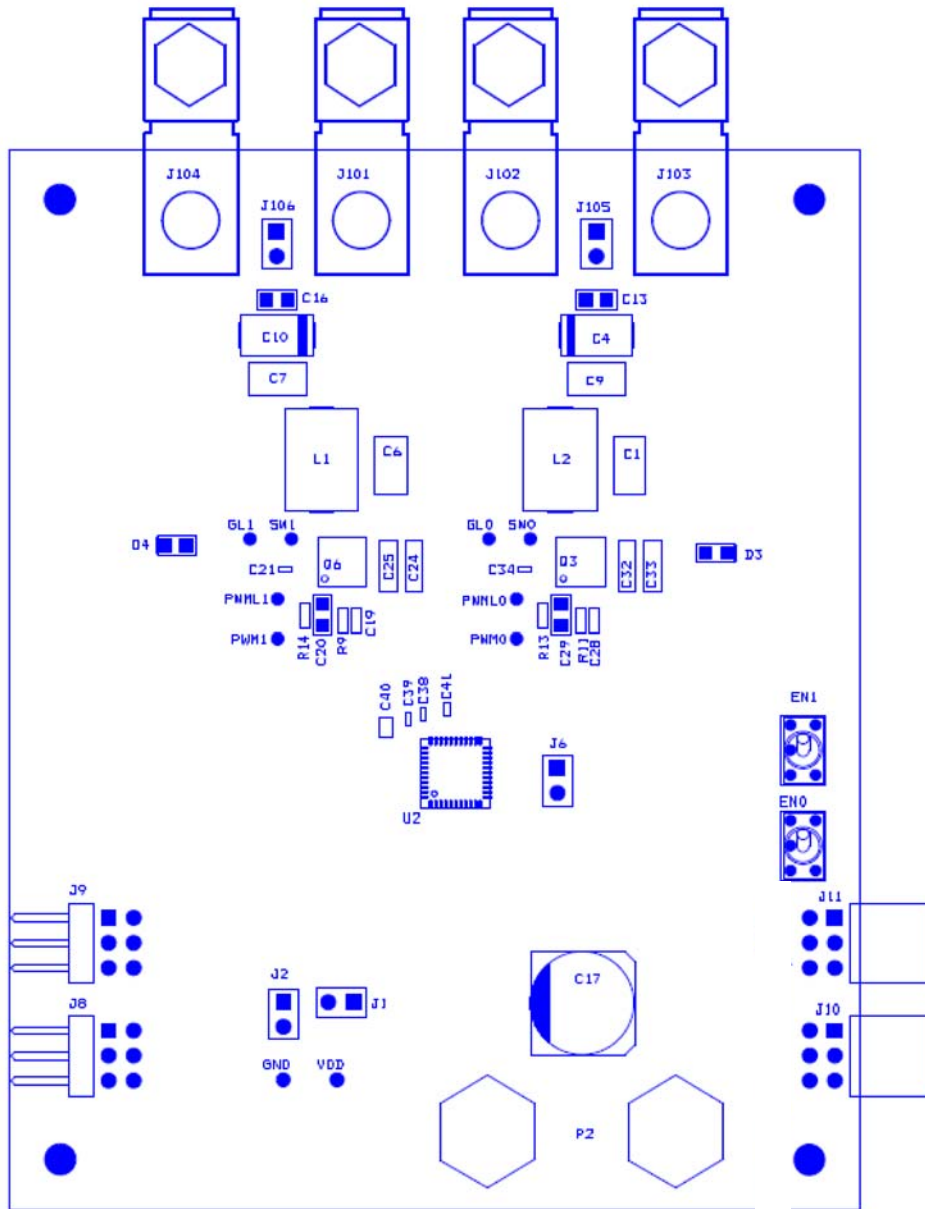

FIGURE 15. PCB - TOP ASSEMBLY

ZL8800-2CH-DEMO1Z Board Layout (Continued)

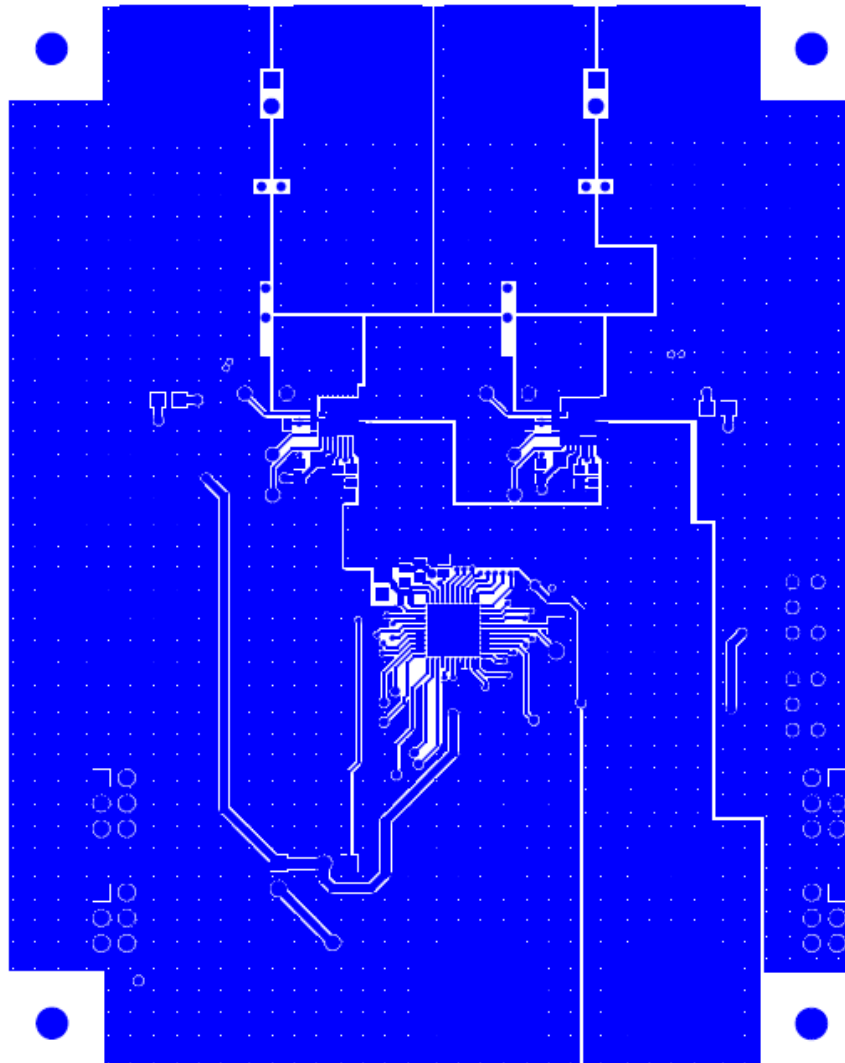

FIGURE 16. PCB - TOP LAYER

ZL8800-2CH-DEMO1Z Board Layout (Continued)

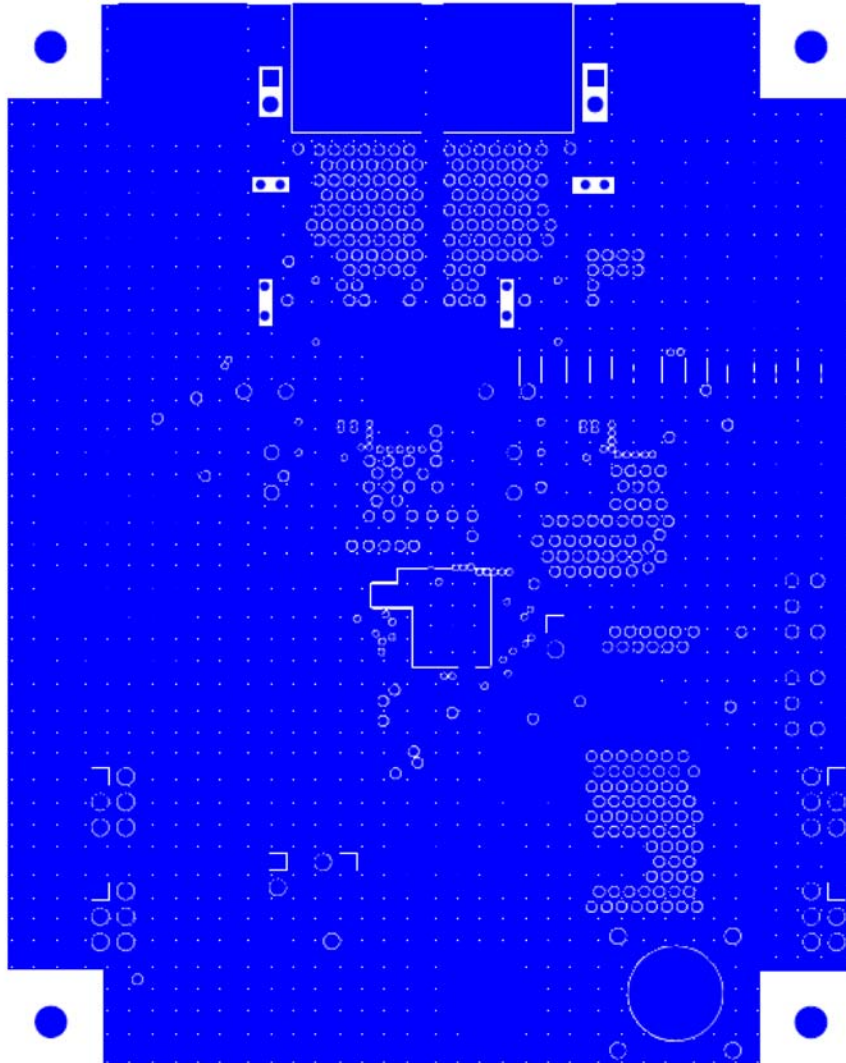

FIGURE 17. PCB - INNER LAYER 1 (TOP VIEW)

ZL8800-2CH-DEMO1Z Board Layout (Continued)

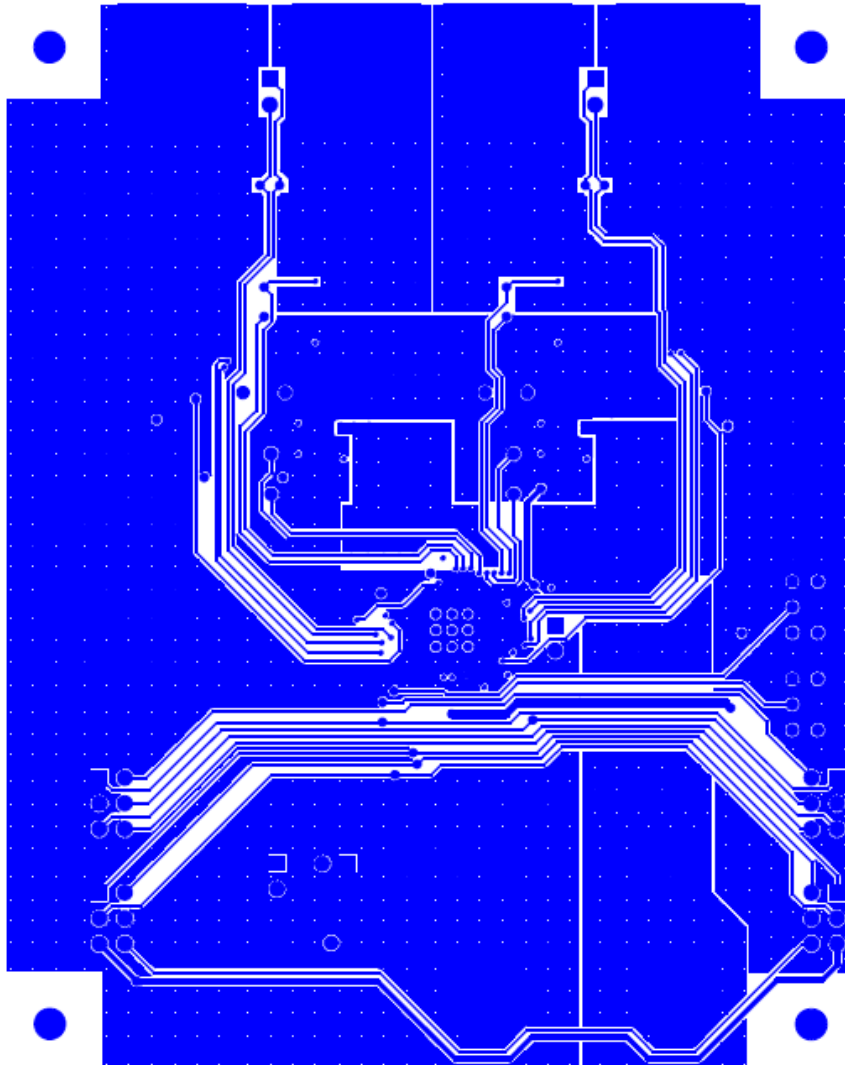

FIGURE 18. PCB - INNER LAYER 2 (TOP VIEW)

ZL8800-2CH-DEMO1Z Board Layout (Continued)

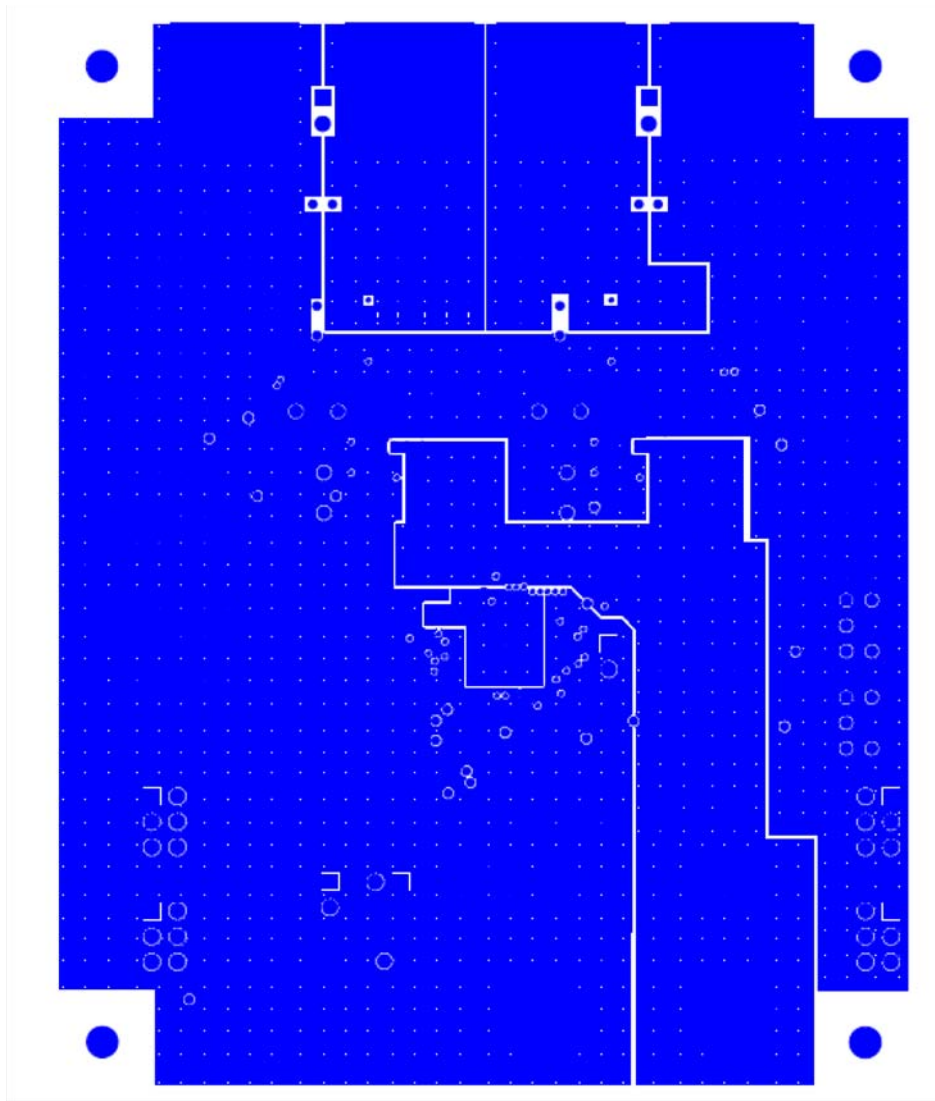

FIGURE 19. PCB - INNER LAYER 3 (TOP VIEW)

ZL8800-2CH-DEMO1Z Board Layout (Continued)

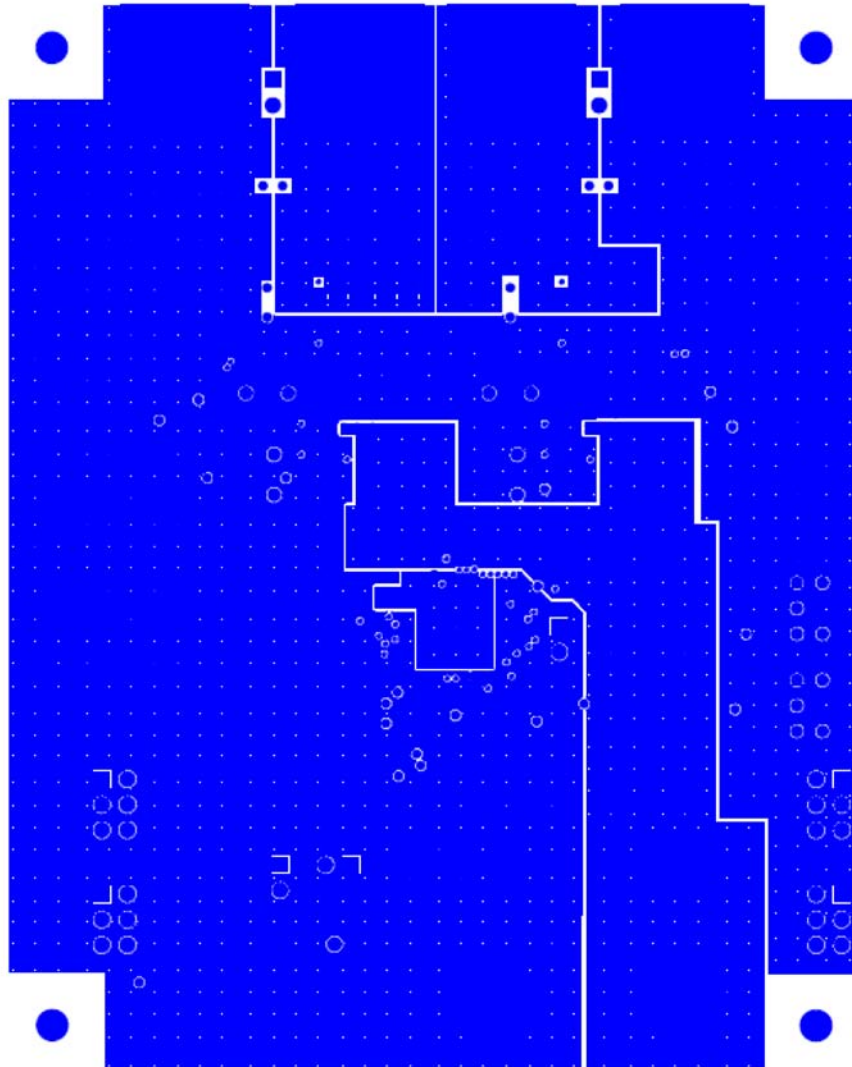

FIGURE 20. PCB - INNER LAYER 4 (TOP VIEW)

ZL8800-2CH-DEMO1Z Board Layout (Continued)

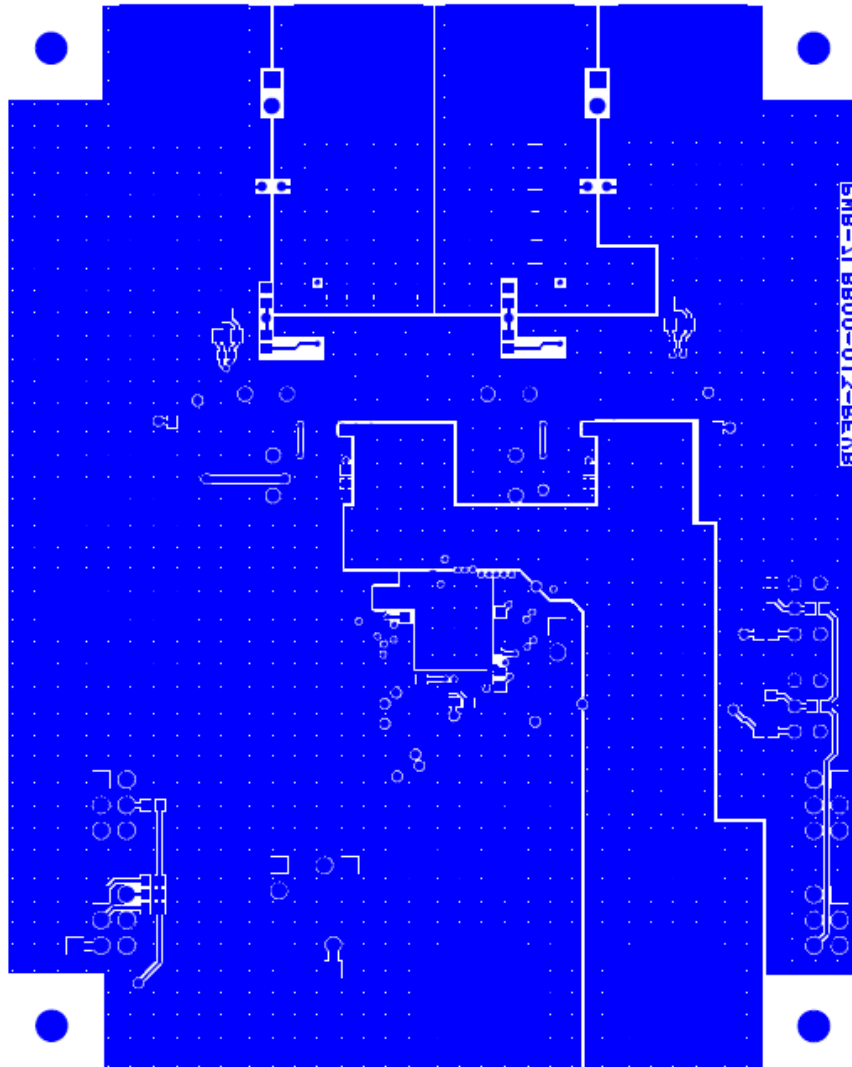

FIGURE 21. PCB - BOTTOM LAYER (TOP VIEW)

ZL8800-2CH-DEMO1Z Board Layout (Continued)

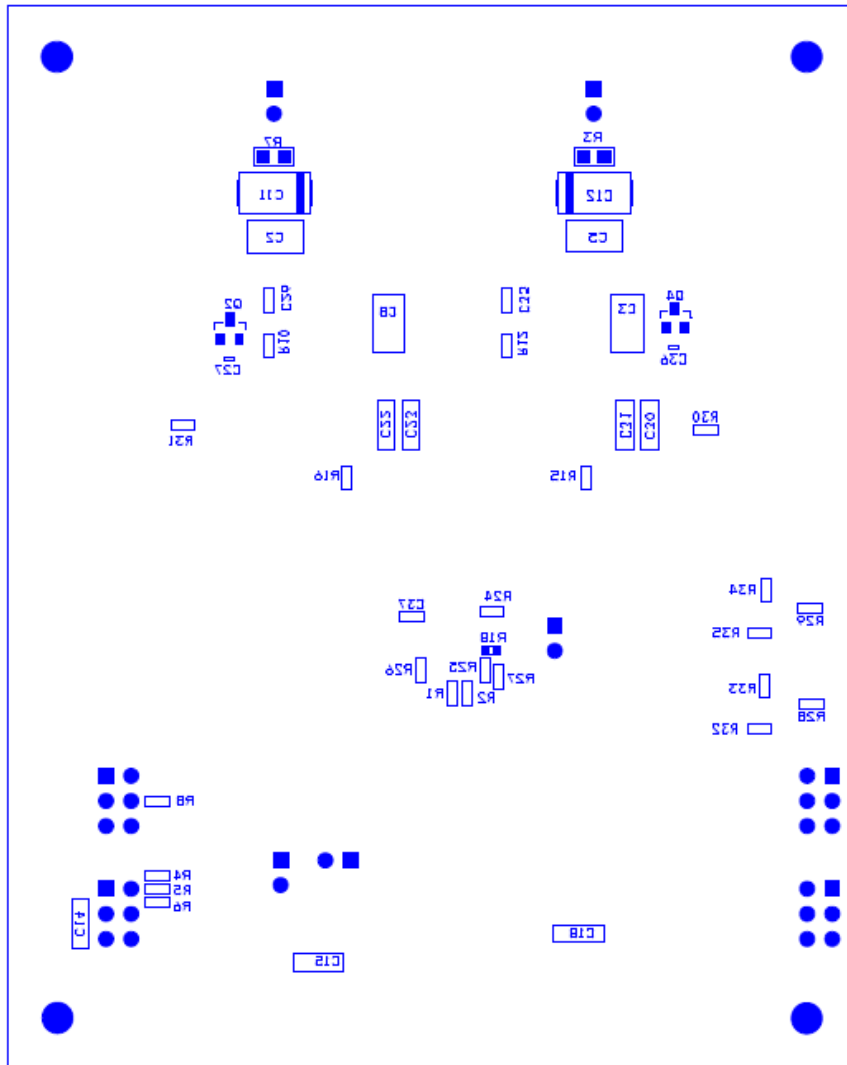

FIGURE 22. PCB - BOTTOM ASSEMBLY (TOP VIEW)

Intersil Corporation reserves the right to make changes in circuit design, software and/or specifications at any time without notice. Accordingly, the reader is cautioned to verify that the Application Note or Technical Brief is current before proceeding.

For information regarding Intersil Corporation and its products, see www.intersil.com